

TELAS DE LOS MUERTOS

CROSSED WARP WEAVES by Sue Baizerman

photos by Karen Searle

Last month the ancient Peruvian technique of knotted weft wrapping was discussed. That technique was noted for its use in creating an open, airy fabric. The more typical and better known form of Peruvian openwork is that which comes under the category "gauze weaves," or as Irene Emery in her Primary Structures of Fabrics calls them, "crossed warp weaves." Best-known are those gauzes which portray animal or geometric motifs executed in the same yarn used in knotted weft wrapping and very similar to them in size and overall impact. Like the knotted weft wrapped pieces, this airy, lacy type of gauze weave comes from the Central Coast area; the archaeological area of Chancay is particularly famous for production of this type of fabric. However, there are other gauzes from many other Peruvian archaeological sites which are quite different from these better-known gauzes. These latter are much more dense and would not be confused with lace.

Unlike the knotted weft wrapping, gauze weaves are found the world over. Tarascan lace from Michoacan, Mexico, is a particularly outstanding and elaborate example.

The Science Museum's collection contains nine examples of Pre-Columbian Peruvian gauze weaves. Three pieces appear to be originally from one textile. These three specimens and the other six in the collection are of such diverse applications of the principles of the construction of gauze fabrics, that each will be discussed individually. First, however, a more general discussion of fabric structure and materials.

The Structure of the Fabric

Like knotted weft wrapping and other plain weaves, the gauze fabrics are comprised of warp and weft. But unlike plain weave, there is a change in the spatial relationships between the threads: warp threads cross and recross one another. They are no longer strictly parallel (though they ultimately return to their original positions in the warp). (See Fig. 1.) Essential to the crossing and recrossing of the warps is the weft—it maintains the shifts taking place in the warp ends.

According to Emery, there are two basic types of gauzes, simple and complex. They will be discussed as they relate to specific museum textiles.

Materials

Like the textiles discussed last month, all of the gauze weaves in our collection are composed of cotton yarns. The white cotton is single ply, "S" twist. The brown cotton is 2-ply, "Z" spun, "S" plied. The yarn is overspun, sometimes to the extreme. Wool is used for patterning threads and for the weaving of borders in contrasting techniques; it is normally very loosely spun and plied.

The Fabrics

1. A-76-18-6 : This textile is a 30" x 32" all white, all cotton rectangle. It is composed of two rectangles seamed together, each a four-selvage cloth. At each end of each rectangle there is a half inch of plain weave, weft-faced. In between these end sections there is a plain 1/1 gauze. This is a simple gauze—two warp ends and two weft passes complete the whole fabric structure. This type of cloth is illustrated in Fig. 1a.

The cloth feels as if it could have been produced last week—it is soft and pliable. Yet the yarn is clearly handspun, over-twisted, and of an incredibly even quality; it is a perfectly crafted piece. There are approximately 25 warp ends per inch and 17 weft passes per inch.

In order to execute this type of plain gauze weave, first a plain weave shed must be opened, a shed where the extreme right-hand thread is raised (see Fig. 1:1). The first lower thread is brought under the first raised thread. Then the next lower thread is brought under the next upper thread and so on. As threads are crossed they are placed on a pickup stick (Fig. 1:2). When the whole row has been worked, the pickup stick is turned on edge and the weft inserted.

In plain gauze weave, this simple crossing of threads is uncrossed by making the plain weave shed opposite from the one used to make the crossings. Threads are then back in their original positions. These two sheds, one to cross the threads, one to uncross, constitute plain gauze weave.

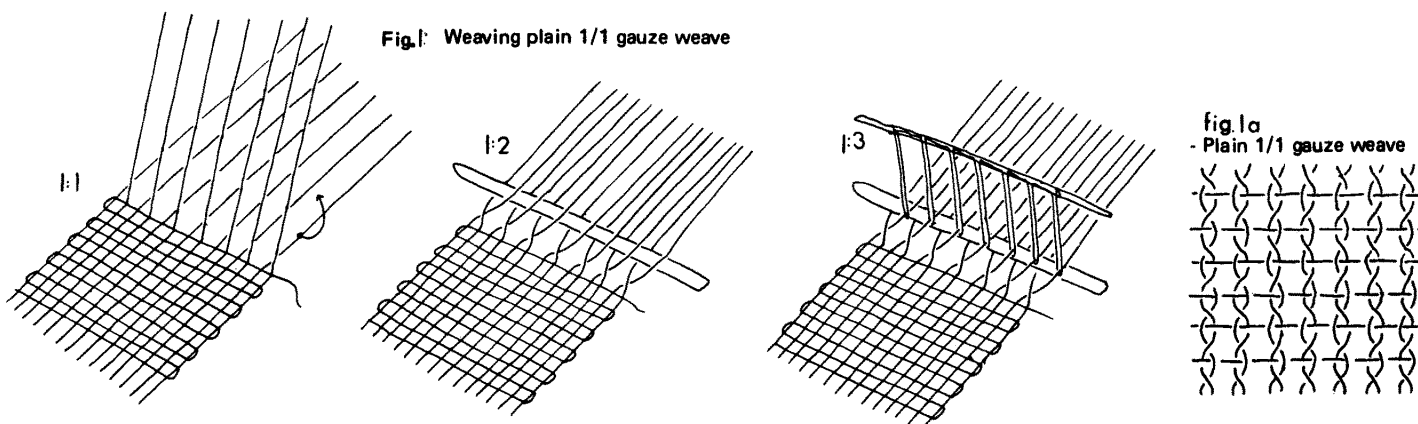

If an entire fabric is to be composed of plain gauze weave, the weaver may decide to use a string heddle to cross the threads. String heddles would be attached to the threads at the time they are crossed and on the pickup stick (Fig. 1:3). On subsequent rows, when the warp ends need to be crossed, the heddle stick is raised and crossing is accomplished automatically and with great time savings. In all likelihood this museum textile was woven with string heddles.

The heddle controlled thread crossing can only be used when a simple plain gauze is the desired result. If the threads shift from the vertical alignment shown in Fig. 1, the crossing and recrossing must be done by hand.

2. A 71-12-3: The second gauze weave textile differs from the first due to the presence of supplementary threads. The ground cloth is a plain gauze weave, in cotton, 2-ply, brown yarn (22–26 warp ends per inch; 6–7 weft passes per inch). The supplementary thread is a two-ply, softly-twisted wool. There are 12–14 insertions of this supplementary thread between the ground weave weft passes.

The supplementary thread would probably have been added most easily while the cloth was on the loom. This could have been done with a needle while the cloth was under tension. Or it could have been done after the cloth was removed from the loom, as in more traditional embroidery. Another possibility would have been extra heddles applied to the loom to create the over2/under 2 course of the supplementary thread. In this case we would have to call this thread a supplementary weft. Note that the supplementary thread interacts with the two thread gauze unit (see Fig. 2).

As Photo 1 indicates, the contrast in texture between the open gauze weave background and the dense tapestry-like supplementary threads produce a cloth of great visual appeal. Other factors add to the appeal: the interaction of colors (shades of red and gold on a dark brown background); the rhythmic interlocking bird motifs; the tasseled borders.

This narrow (4½" x 16") panel was probably a border on the lower edge of a garment. Three selvages are intact.

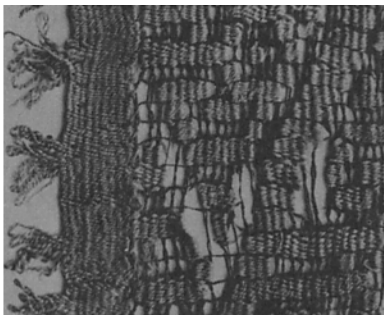

Photo 1 – A 71-12-3

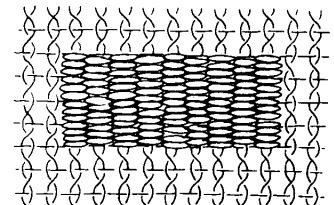

Fig 2- Plain gauze weave with supplementary thread patterning

3. A 74-16-26: In Peruvian textiles, one may also find alternating plain gauze weave (Fig. 3). Here, the same two threads do not repeatedly cross and recross; they do not stay in vertical alignment. Instead, the two thread unit is divided and forms a new two-thread unit.

The textile now under study combines a plain gauze weave with an alternating gauze to create a pattern (Photo 2). This is essentially a block pattern bordered by two threads which first join one block, then another.

This particular textile is unusual because it has a white warp (sett at 18 ends per inch) combined with a brown weft (7 passes per inch). Such color contrast in warp and weft is very unusual in Peruvian textiles. This piece is in good condition, supple and bright, with only a few holes. Like the textile above, its beauty is enhanced by contrast, this time between the gauze pattern and the complementary weft patterning on the borders. The latter patterning is executed in three colors; red, white, and black; and is non-reversible. Interestingly, the very thick borders are woven on the same warp as the delicate gauze!

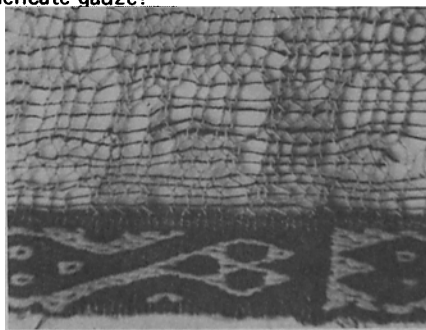

Photo 2 – A 74-16-26

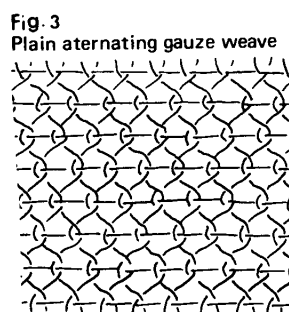
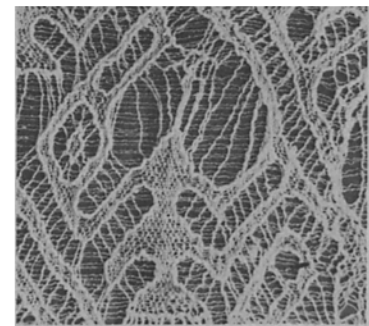

Photo 3 – A 76-17-8



4. A 76-17-8: The ancient Peruvians were particularly famous for their elaborate gauzes which portrayed animal and geometric motifs. This textile (photo 3) is such a good specimen, with beautiful bird forms combined with geometric ones, that it is very reminiscent of knotted weft wrapping (see back cover, September issue, Minnesota Weaver). It measures 32" x 40" and is made up of two 20" panels seamed together.

Like the textile described just above, this cloth's design is formed out of the contrast between plain gauze and alternating gauze weaves.

When we museum workers first noticed this specimen, it was simply a mass of cotton threads, seemingly undistinguished. It was only after careful unfolding that we discovered this exceptionally beautiful textile. It has many large holes and stains but the cloth that remains is of an exceptionally high quality. Yarns are extremely fine and overspun to such an extent that the design is obscured until the cloth is gently stretched. (Whether this is intentional or not is an interesting question.)

5. A 76-17-2; A 76-17-14; A 76-17-15: Because of the similarity of design, thread count and diameter, and correspondence of cut ends, we have concluded that these three cloths were probably originally one cloth. The projected cloth would be of a similar size to the ones discussed above. They are woven with very fine, white cotton yarns (38–40 ends per inch; 26 weft passes per inch); very well crafted.

In the cloths described thus far, a single thread has been crossed and recrossed around another thread. In this cloth, two threads are crossed and recrossed around two others (see Fig.4). It is executed in the same manner as plain gauze. The shed is opened with the farthest right thread up. Then the first two lower threads are brought up and placed to the right of the first two upper threads. The crossing and recrossing is done at selected intervals yielding the pattern of concentric diamonds; in Fig. . each "x" indicates where the crossing is done.

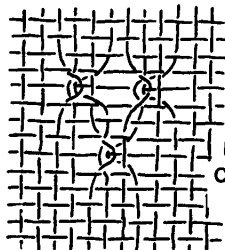

Fig. 4 –
Complex gauze weave



Fig.4a pattern diagram

6. A 72-24-12: This textile differs from those so far discussed because it is a more identifiable garment—a vest or “vestido”—composed of two long rectangles. These two rectangles are joined at the sides up to the armholes and down the center except for the neck opening. The piece measures 26” x 29” and is woven 50 warp ends and 15 weft passes per inch.

This garment demonstrates the use of gauze weave in a dense fabric: it is only upon close examination of the fabric that one can distinguish the gauze pattern. Like the textile above, it is a diamond pattern but it varies from the concentric diamond format of the previous textile. Photo 4 will clarify the difference.

As with the second and third textiles described above, the visual appeal of this textile is enhanced by a border of contrasting fabric construction, woven on the same warp. A supplementary weft pattern of cat motifs is used. Colors and textures of the border contrast with the gauze-woven portions. In addition there is a fringed tape sewn to the lower border of the garment.

The gauze pattern employed here brings four threads from the lower threads up under four threads from the upper threads, another simple variation from plain gauze weave.

The faint diamond pattern in the gauze weave is emphasized by embroidery outlining the diamond pattern. (The embroidery stitch utilized is the twined double-running stitch.)

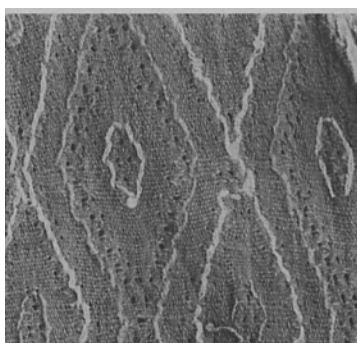

Photo 4 – A 72-24-12

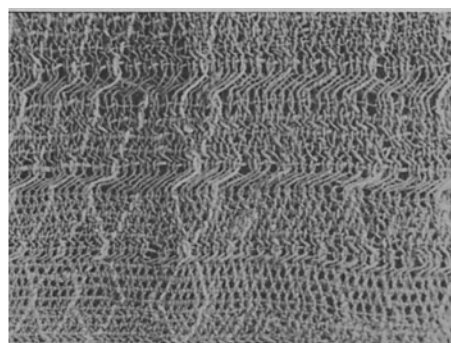
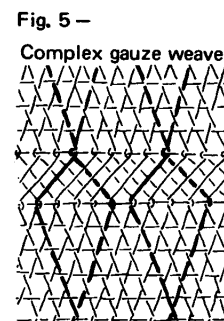

Photo 5 – A 72-23-2



7. A 72-23-2: In this complex gauze weave, color is introduced into the warp, making it in this respect unlike any of our other crossed warp weaves. As the weaving progresses, these colored threads are diverted, then returned to position, creating a small, all-over diamond pattern and an interesting texture (Fig.5).

In preparation for weaving this cloth, the warp would be arranged as follows: 8 brown threads (2-ply brown cotton), 2 threads of another color (shades of gold and red wool), repeat. To weave, five weft passes would be made in an alternating gauze weave structure. These are woven without the usual alternation with plain weave sheds and warp threads are therefore not returned to their normal position with every other weft pass. On the sixth passage of weft, the plain weave shed is finally brought forward, returning the warp ends to their original position. This succession creates a periodic heavy diagonal patterning in the cloth (see Photo 5). You will notice that threads do not cross and recross except for the first and sixth weft passes, but rather interlace as in plain weave, but on a diagonal.

This textile is in very poor condition, having many large holes. It measures 24” x 28–31½”.

Similar to the vestido described above, there are approximately 26 warp ends per inch and 6–7 weft passes per inch. This higher warp to weft ratio results in a denser cloth.

For the Handweaver: We hope that the above descriptions will stimulate you to experiment more with the crossed warp weaves. For more information refer to Hilary Chetwynd's article in the Summer, 1974, issue of Shuttle, Spindle and Dyepot, “Experimenting with Leno Weaves,” and Baizerman and Searle's Latin American Brocades, as well as the Tidball monograph on Two Harness Open Work Weaves.