

Fig. 165. The latter shows two repeats painted on 6 by 6 point paper to more clearly illustrate subject. One repeat of it is all that is required to be made; by

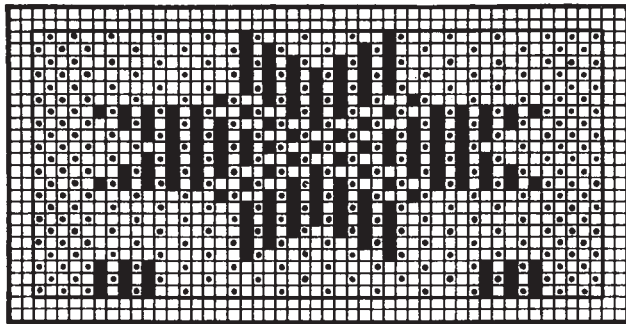

Fig. 166

the designer for practical work; drawing in draft and harness chain are made out in the usual way.

Fig. 166 is given to illustrate the analysis of figure and ground warp, as they interlace with the filling in the fabric structure. The ground warp is shown by dot type, the figure warp by full type.

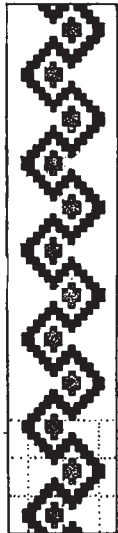

Fig. 167

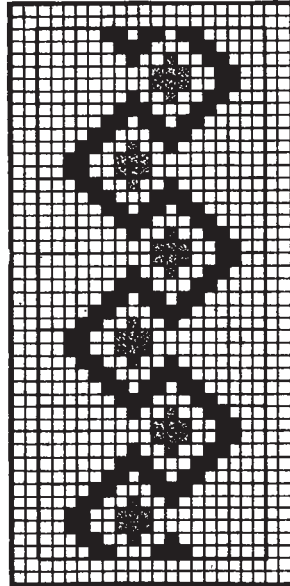

Fig. 168

The arrangement of the warp is thus:

- 4 ends ground
  - 1 end ground
  - 1 " figure
  - 4 ends ground
- } 19 times

46 ends, repeat.

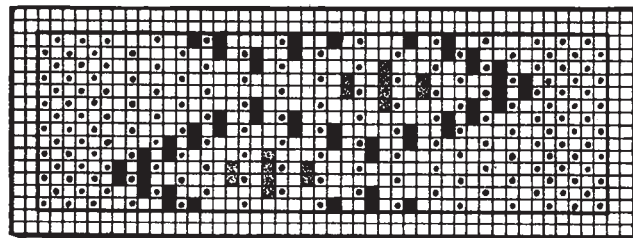

Fig. 169

It is immaterial what kind of point paper we use for illustrating the interlacing of both systems warp with the filling in diagram Fig. 166, having used for this reason plain point paper, *i. e.*, such as is not over-ruled with heavy squares.

**Producing Figures in Smooth Ribbons.**

**3 SYSTEMS WARP: 1 SYSTEM FILLING.**

Fig. 167 shows us a sketch for a ribbon calling for two systems figure warp and one system ground warp used in connection with one system filling. One system of figure warp is shown in *black* and that of the other in *gray*. Six repeats of the design are given.

The lower portion of sketch Fig. 167 is shown ruled-off, by means of dotted lines, to correspond to the heavy ruled squares on the point paper design Fig. 168, which shows three repeats in length of pattern. The ground warp-threads are not shown on point paper design Fig. 168; the two figure warp-threads are represented on the same row of squares in a vertical direction, one system in one color (see *full* type) and the other system in another color (see *gray* type). The point paper used is 6 by 6, which means that figure warp-threads (considering the two systems where they appear on one line as one thread) equal in texture the picks.

Fig. 169 shows the interlacing (one repeat) of all the warp-threads with its filling for design Fig. 168. The ground warp-threads are shown by means of *dot* type, the two figure warp-threads by means of *full* and *gray* type, respectively.

**REVERSIBLES.**

**HARNES AND JACQUARD WORK.**

(Continued from August issue.)

**Jacquard Work.**

The principle of designing these double cloth reversibles as previously explained in connection with

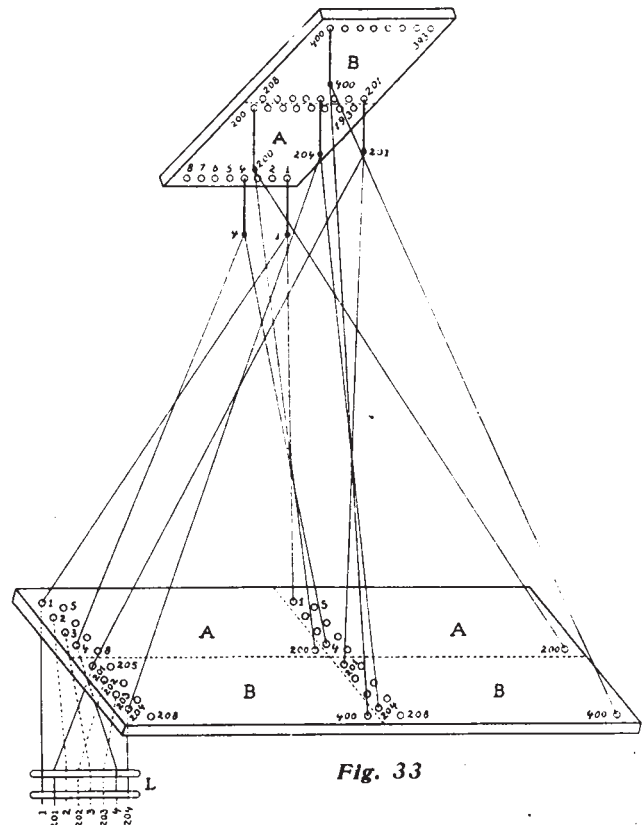

Fig. 33

harness work, also finds extensive use with Jacquard work.

Two systems of tie-ups are available for this purpose, viz:

- (a) the two section tie-up.
- (b) the common straight through tie-up.

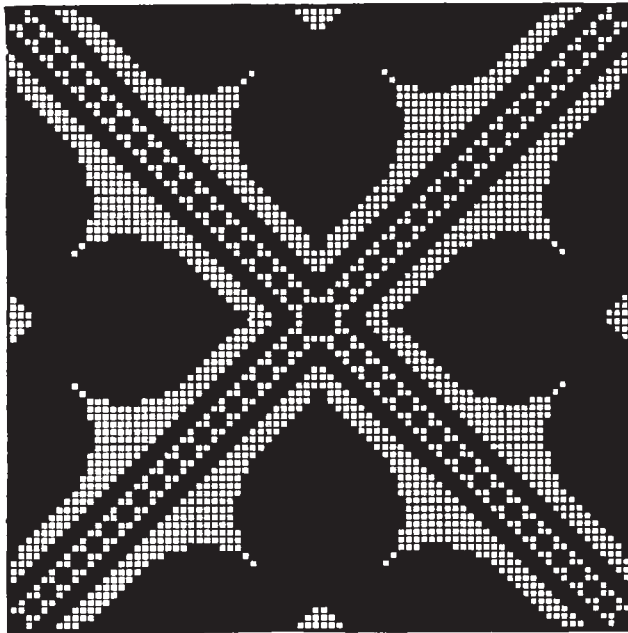

Fig. 34

THE TWO SECTION TIE-UP.

Fig. 33 shows the plan for this method of a tie-up for a 400 Jacquard machine (no notice of reserve rows is taken). The principle of threading the Jacquard harness, observed in either section is straight through.

From the diagram, it will be seen that the machine and the comberboard are divided into two even parts, marked *A* and *B*.

In the rear section *A* of the comberboard we threaded, on a straight through tie-up, the harness cords as operated by neck cords, protruding from section *A* of the bottom board of the Jacquard machine. In a similar way the front section *B* of the comberboard carries on a straight through tie-up, the harness cords as operated by the neck cords, protruding from section *B* of the bottom board of the Jacquard machine.

The comberboard is shown arranged for 2 divisions, explaining at the same time any number of divisions that may be called for.

The threading of each division of the comberboard starts on its first row deep with harness cords from leashes 1, 2, 3 and 4 for section *A* and 201, 202, 203 and 204 for section *B*, followed on the second row deep with harness cords from leashes 5, 6, 7 and 8 for section *A* and 205, 206, 207 and 208 for section *B*, until ending the tying up of the harness on the fiftieth row deep of the comberboard with harness cords from leashes 197, 198, 199 and 200 for section *A* and 397, 398, 399 and 400 for section *B*.

To simplify illustration, only such harness cords are shown threaded in the comberboard as are required to explain subject, viz: first and last harness cords for first row of each section (1, 4, 201 and 204) and the last harness cord of the last row (50th) for each section (200 and 400).

The leasing of the harness cords for the purpose of drawing-in the warp is always done by alternately threading one cord from section *A* and that of section *B*, as shown in diagram at *L*, below the comberboard.

Section *A* may refer to either figure or ground effect, section *B* then calling for its respective mate effect.

Fig. 34 illustrates a portion of a design (80 by 80 lines) intended to be produced in double plain reversible, to be made on a loom tied up in two sections. Allowing two warp-threads and two picks for each vertical and horizontal row of squares of the design on the point paper, and considering for sake of an example a 400 machine with section *A* to be figure effect and section *B* ground effect, the stamping of the cards from design Fig. 34 will be thus:

1<sup>a</sup> cut black for section *A*; cut plain weave  $\downarrow\uparrow$  for section *B* (insert ground pick).

1<sup>b</sup> cut plain weave  $\downarrow\uparrow$  for section *A*; cut white for section *B* (insert figure pick).

2<sup>a</sup> cut black for section *A*; cut plain weave  $\downarrow\uparrow$  for section *B* (insert ground pick).

2<sup>b</sup> cut plain weave  $\uparrow\downarrow$  for section *A*; cut white for section *B* (insert figure pick).

The plain weave for each half card may be cut

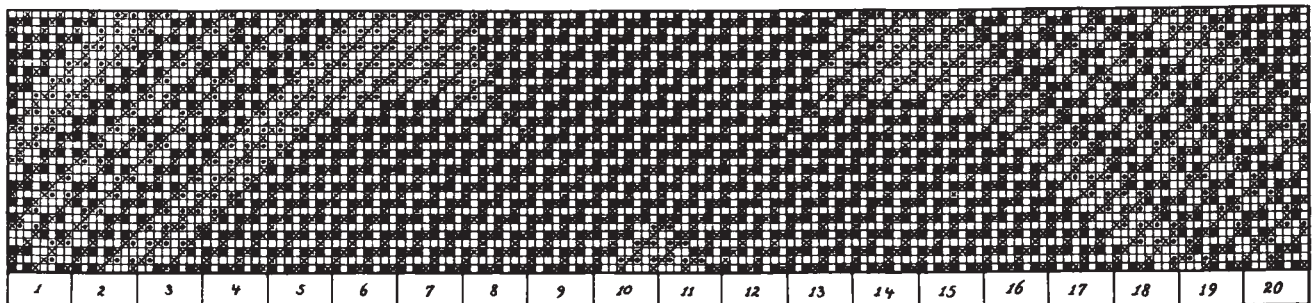

Fig. 35

The Jacquard machine used for explaining subject is a 400 machine, with 200 needles, hooks and neck cords for each section, using

- needles, etc. 1-200 for section *A*,
- needles, etc. 201-400 for section *B*.

Only the first and the last row of each section of the bottom board of the Jacquard machine are indicated in the illustration, so as not to bewilder the reader with too many lines.

ahead on a repeater in quantities and when the card stamper then only has to cut the remaining half card, i. e., the design only.

An analysis of the interlacing of the fabric showing threads as rest in the 2-ply structure, one above the other (in this instance side by side on the design paper) is given in Fig. 35, representing the 80 warp lines (160 warp threads) of design Fig. 34 with its first 16 filling lines (32 picks).

Black type in Fig. 35=black type in Fig. 34.  
 Dot type in Fig. 35=empty type in Fig. 34.  
 Cross type in Fig. 35 is the plain weave for the two plies of the fabric structure, cut on the card stamper, or a repeater, as previously explained.

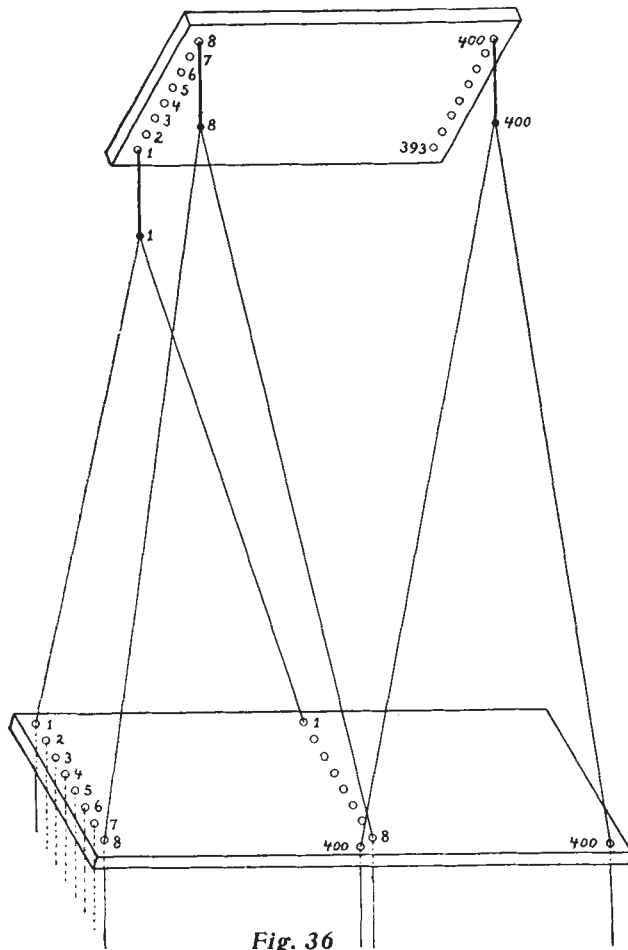

Fig. 36

THE PLAIN OR SINGLE SECTION TIE-UP.

Fig. 36 shows us the most approved arrangement of this tie-up, also known as the English system, applied to a 400 Jacquard machine with 2 divisions (more may be used without changing the principle of the tie-up) in the comberboard. In this system of a tie-up, the Jacquard machine is adjusted on the loom so as to have its cylinder placed parallel with the comberboard. If dealing with a 600 Jacquard machine, with 12 rows, the comberboard will also have 12 rows.

Considering the card stamping from design Fig. 34 in connection with such a single section, *i. e.*, straight through tie-up, let us first examine the analysis of the fabric structure given in Fig. 35, and which was constructed thus:

- (1) Insert the  $\frac{3}{1}$ -4-harness twill, see *cross* type.
- (2) Insert figure effect of design Fig. 34, considering only the uneven number of warp-threads and this on the uneven number of picks (see *black* type).
- (3) Insert ground effect of design Fig. 34, considering only the even number of warp-threads, and this in connection with the even number of picks (see *dot* type).

The card stamping is done direct from the design (Fig. 34), based on explanations just given in connection with the fabric analysis.

Fig. 37 explains the subject of how the cards are cut directly from the design, showing the stamping of a portion of the first four cards, representing a portion of the first four picks of our fabric analysis, *i. e.*, a portion of stamping from the first two lines of design Fig. 34. The cards are shown in two stages, *vis*:

*A* shows the stamping of the double plain principle, *minus* raising face warp on every back pick, or as we have called it previously (to simplify matters to the readers) shows the  $\frac{3}{1}$ -4-harness twill. This cutting is repeated on every four cards in the set.

In practical work the cards are numbered 1<sup>a</sup>, 1<sup>b</sup>, 2<sup>a</sup>, 2<sup>b</sup>, 3<sup>a</sup>, 3<sup>b</sup>, etc., indicating by these numerals the respective lines on the design they refer to.

Letter of reference *a* indicates, in the present example, *cut figure* or *black*, or as the card stamper would get it on his design *cut red*.

Letter of reference *b* indicates *cut ground* or *empty*. The cards are cut with reference to the 4-harness twill, in changes of four, if in quantities on the repeater, or with small designs on the card stamper.

Jacquard cards are stamped, *i. e.*, to be read from left to right, row for row, and which means to the reader to read cards in Fig. 37 downwards. In the repeat of the 4-harness twill, *i. e.*, 4 threads,

Card 1 reads: 3 down 1 up, *i. e.*, miss 3, cut 1;

Card 2 reads: 1 up 3 down, *i. e.*, cut 1, miss 3;

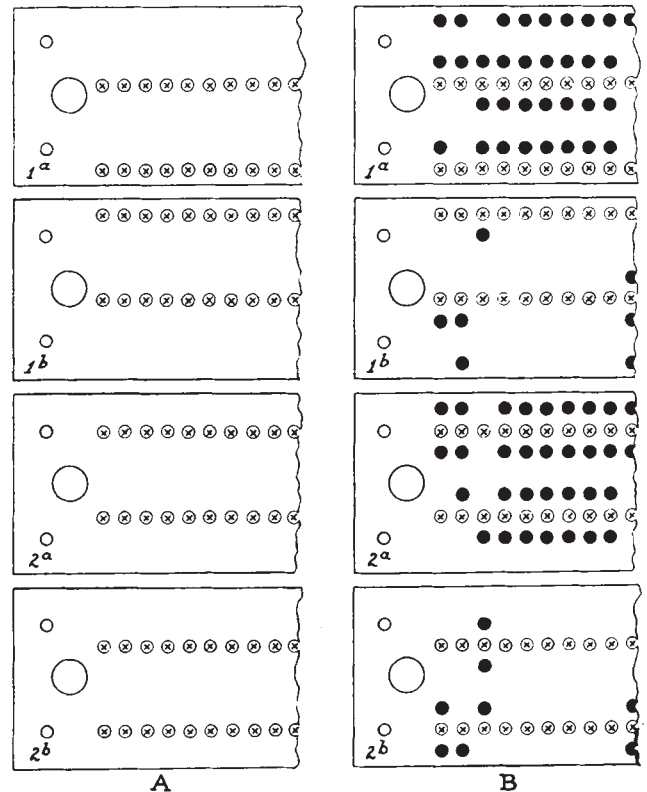

Fig. 37

Card 3 reads: 1 down 1 up 2 down, *i. e.*, miss 1, cut 1, miss 2;

Card 4 reads: 2 down 1 up 1 down, *i. e.*, miss 2, cut 1, miss 1.

After having cut the 4-harness twill into the required number of cards needed for the design, and which must be a multiple of four (4), then in connection with

- Card 1<sup>a</sup>: cut figure; cut 1st line *black* from design;  
 Card 1<sup>b</sup>: cut ground; cut 1st line *empty* from design;  
 Card 2<sup>a</sup>: cut figure; cut 2nd line *black* from design;  
 Card 2<sup>b</sup>: cut ground; cut 2nd line *empty* from design,

and keep on this way until the complete repeat at the design is cut. Black in our illustration means red for the card cutter.

*Cross* in circles show the cutting of the 4-harness twill, corresponding to mate card shown at (A) the left.

*Black* circles show the stamping of the design; both cuttings being easily traced to the fabric analysis Fig 35.

To simplify matters for the reader, we have shown the fabric analysis Fig. 35, ruled off, below, indicating the corresponding rows on the Jacquard card, the first 20 rows being shown in the analysis. Nine complete rows and one broken row are shown on each card (B Fig. 37).

(To be continued.)

## COTTON CARD CLOTHING.

(Continued from June issue.)

### Grinding.

With reference to round wire there are two periods when card teeth are ground, the one during manufacture, and the other after the clothing is applied to the machine in the mill.

Card teeth are ground during the manufacture for two reasons, *viz.*, to enlarge the space between contiguous teeth, and to leave the surface true and level.

The first of these operations comprises what is known as plough and side grinding, both by no means being synonymous, although they have the same object *i. e.* to produce what is very erroneously called a *needle point*. It is quite obvious that the production of anything of the nature of a needle point is impossible after the wire is fixed in the foundation. What is technically called a needle point is practically a knife edge, the metal on the sides of the teeth being ground away, so that each tooth as it approaches the cotton presents to it a more or less sharp edge, for the purpose that when the surface grinding of the clothing takes place in the mill in order to resharpen the teeth, there is always an approximately sharp surface dealing with the cotton.

Plough grinding has for its object the reduction of the tooth for a great part of its depth, and is effected during the process of manufacture thus: After the fillet has been made it is traversed over a perfectly true cylinder at a slow speed; thin emery discs are thrust between the teeth, and being revolved at a very high velocity, grind off from the sides of the teeth a certain portion of the wire. The discs are preceded by small *furrow* guides or *ploughs*, by which the various rows of teeth are kept apart, so that each tooth is equally ground on both sides. The tooth, when looked at from the front after grinding, presents from a little below the knee a taper profile.

With reference to side grinding the intention is to deal with the extreme points of the teeth only. Hardened and tempered steel wire, plough ground, seems to be most in demand, since it is adapted for nearly all classes and growths of cotton. The chief

reasons advanced for its being preferred are that owing to its hardness, the points, when once got up by grinding, are retained much longer than mild steel wire points, thereby increasing the life of the wire to a great extent. Better carding and a greater production are obtained, due to the wire being better able to treat a thicker body than mild steel wire, and to the card being stopped less for grinding. To be successful with hardened and tempered wire, assuming that it is put in a sufficiently strong foundation, is wound at the correct tension and has the proper amount of angle given to it in order to enable it to strip clear, it is an absolute and imperative necessity that the wire should be ground in an efficient manner, that is, sufficiently hard to cut it.

It is generally conceded that to wait until the points of the teeth are dull and then grind them on the top is a mistake, and it is infinitely better to grind lightly for a few minutes often than to grind heavily for a longer time and at greater intervals.

Heavy grinding results in softening and fusing the wire, causing barbed and hooked points, also destroying rigidity and correct angle of the wire, and should the foundation not possess sufficient elasticity it will result in broken teeth. Most card-makers recommend 40's counts of emery covering for the grinding roller. Some card men prefer to use a coarser count than 40's, as they claim to get a keener point on the wire, and quicker than with the finer points. This is so, but at the same time they get a rougher point, and this is not so conducive to a bright and smooth yarn.

The length of time a card should be ground depends, of course, on the condition of the wire at the commencement of grinding. Where the cylinders and doffers have been in contact for some time, causing the points to be very smooth, the dead or solid roller should be used until the points are got up all across and feel like, the disc roller being applied to finish. The rollers should be set to a fine gauge at both ends of the cylinder or doffer, and then lowered, while rotating, to the operator's judgment, and should in every case be kept working until the wire is parallel across the width of the card, so that even setting will be obtained. All should be got up or ground and set once per month. The weight of cotton passed through cards, and the quality of the carding desired, affects the time that should be allowed to elapse before again grinding. This is a matter which, however, rests with the discretion of the person in charge.

It should be noted that, when setting, care must be taken to avoid stabbing cylinders and doffers with the gauge, as this is misleading through the spring or resilience of the wire, and also risky to the wire itself. When new grinding rollers are obtained, it is very good practice to gauge them to see that they are perfectly true in diameter, straight, and also see that they are properly balanced. The grinding brackets should be tried when the grinding rollers are for the first time put in, to see that the roller is parallel with the cylinder and doffer shafts. The grinding rollers are also best ordered, so that they can be recovered at the mill with emery filleting when the other is worn.

Before the card is ready for grinding, the wire must be all drawn up with the card knife in good shape, and all the bent wire picked up and tubed in line. If the picking up of the fallen teeth is neglected