

# Power Transmission in Textile Mills

By Charles L. Hubbard

## Angle Couplings.

These couplings, sometimes called "universal joints," are used where it is necessary to change the direction of a shaft a limited amount without the use of bevel gears or special arrangements of belting. The joint or coupling shown in Fig. 34 has a working range up to 25° between the axes of the two shafts, while a double joint of the same type will operate up to an angle of 70°.

The speed of a universal coupling should not exceed 200 r. p. m., and in any case the angle and speed of shaft should

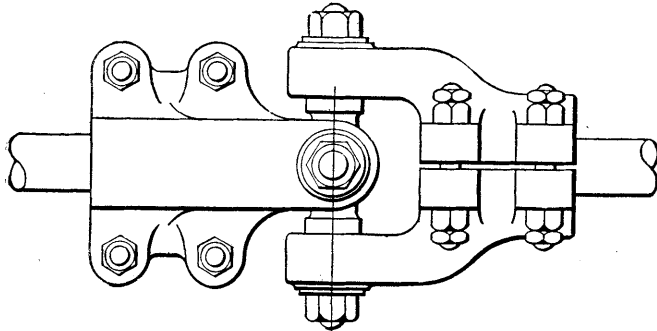

Fig. 34. Angle Shaft Coupling.

be considered together when planning for a device of this kind. Standard forms of these couplings are made to operate on shafts up to 5 inches in diameter.

## Collars.

To prevent a line shaft from having too much play lengthways, it is common practice to place a collar at each end near a bearing. In many cases the same result is obtained by placing a pulley near a bearing and letting the hub act as a collar. This arrangement is open to the objection that oil is apt to work out from the bearing and be thrown by



Fig. 35.

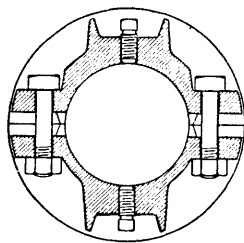

Collars.

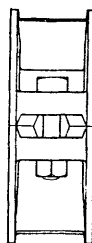

Fig. 36.

the rapidly revolving shaft upon the belt passing over the adjacent pulley, a condition which should always be avoided when possible. The collars used for this purpose are of two general forms shown in Figs. 35 and 36. The first, Fig. 35, is solid and must be slipped on over the end of the shaft. The second is made in halves and can be put on and taken off without disturbing the shaft. As in the case of couplings, there should be no projections, such as bolt heads or set screws for catching the clothing of operatives.

## Bearings.

Under this heading is included a great variety of appliances of especial importance in the transmission of power. It has previously been stated that under average conditions from 30 to 40 per cent. of the power delivered to the line shafting is lost in friction before it reaches the points at which it is to be used, and that in many cases these figures are greatly exceeded. As this waste of energy takes place

almost entirely at the bearings it is important that this detail of power transmission should receive careful consideration.

A shaft bearing consists of two essential parts, the *box*, so called, and the *support*. The box ordinarily consists of a cast iron shell lined with a softer metal and provided with a special means for lubrication.

The bearing is divided longitudinally into an upper and a lower half so it may be placed on the shaft after the latter has been supported in position.

A typical bearing of the ring-oiling type is shown in Fig. 37 and illustrates the general construction of this device. The bearing proper with its special lining is indicated by the letter H. The outer shell projects beyond the inner bearing in order to prevent oil from being carried outside and thrown from the shaft by centrifugal force. An oil reservoir is pro-

Fig. 39. Bearing With Wicks.

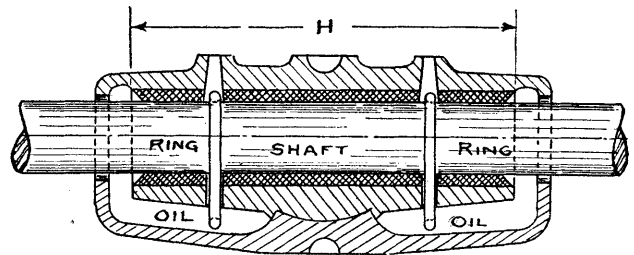
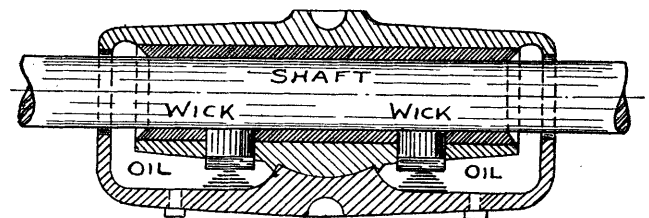

Fig. 37. Ring-Oiling Bearing.

vided at the bottom of the casing as shown. Continuous lubrication is accomplished by steel rings of a larger diameter than the shaft, which dip into the oil at the bottom and carry it up over the top as they slowly revolve. Either one or two rings are provided, according to the length of the bearing, and in some makes chains are substituted for the rings.

When placed at the end of a line or on a counter-shaft, one end of the outer casing is usually closed, and sometimes enlarged sufficiently to include a collar. With bearings of this type oil should be added about once in three months and the reservoir should be cleaned and refilled with fresh oil about once a year.

In the bearing shown in Fig. 38, a split collar is clamped to the shaft at the center. Oil stored in a reservoir at the bottom is continuously elevated to a distributing reservoir at the top by the act on of the collar, from which it flows by gravity over the entire surface of the journal, as shown. In addition to replacing the rings previously described, the collar takes the end thrust of the shaft in either direction, thus doing away with outside collars except under especially severe conditions. Furthermore, the collar runs in oil against babbited seats instead of unlubricated iron surfaces as is the case with an outside collar, where no oil is present unless it works out of the bearing.

When oil leakage does take place, as noted above, it is liable to be thrown off from the rapidly revolving collar, a

(Continued on following page)

# The Identification of Textile Fibers

By Dr. Louis J. Matos

One of the most important chemical points to be observed by those following micro-chemical work with fibers, is to make a positive distinction between cotton and flax. Many directions for distinguishing cotton and flax have been published, but one of the most important is to employ olive oil or two dyestuffs, methylene blue or safranin. If threads of cotton and flax are immersed at the same time in a weak solution of methylene blue for a few minutes, it will be found after washing, that the flax has taken up a much greater depth of color than the cotton. On the other hand, if some threads are placed in a solution of ammoniacal fuchsine, the flax fibers will be found more heavily stained than the cotton.

The olive oil test for cotton and flax is based upon certain physical characteristics that have to do with the transmission of light through cotton and linen mixed cloth, or with the reflection of light from such cloth.

If a piece of clean cloth, containing both cotton and flax is slightly saturated with olive oil, the excess of oil removed, the cloth covered with a cover-glass, and examined under a low-power microscope and with transmitted light, that is, light projected through the instrument from the mirror, the cotton fibers will appear very non-transparent and dark, while the flax fibers will appear almost clear. On the other hand, if the light is reflected down upon the specimen on the glass, the cotton will appear quite white and brilliant, while the flax will appear dark.

Another test for cotton and flax is to soak a clipping of the fabric in a few drops of 66° sulphuric acid for one to two minutes, and then wash well in water and dry. By this treatment the cotton becomes disintegrated, while the flax fibers remain almost intact.

Observe first with low power and afterwards with the higher power, noting all the characteristics of the outline of

## POWER TRANSMISSION IN TEXTILE MILLS.

(Continued from previous page)

condition to be avoided in textile mills so far as possible. With the enclosed collar, this is avoided, thus making it especially adapted to this class of work. When used on line-shafts it is best located at or near the main driving pulley.

In the bearing shown in Fig. 39 the oil is supplied to the journal through wicks by capillary attraction. With this arrangement oil should be supplied about once a month, nearly to the bottom of the journal, and the reservoir cleaned and

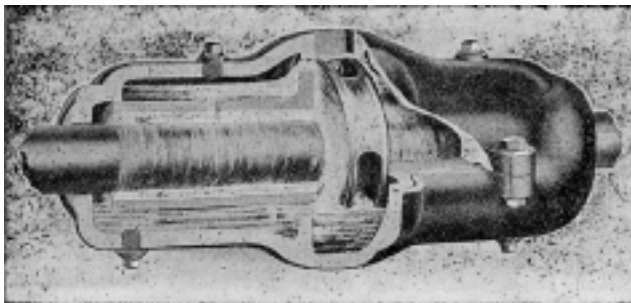

Fig. 38. Split Collar Bearing.

refilled every three to six months, according to speed and surrounding conditions. The wicks used for this purpose are constructed of various material including felt, wood and metal and must be sufficiently porous to produce the necessarily capillary attraction. Certain forms are provided with means for moving them up against the shaft automatically as the upper end becomes worn or the shaft is pulled away slightly from the bottom of the bearing.

the section and particularly of the canal or "lumen" in the center of the fiber section. Observe particularly whether this canal contains or is free from deposits of granules. Observe also any distinctive coloration, and if possible make comparisons with authentic drawings of the cross section of the fibers of known origin and identity.

The cross section of the flax fiber is, roughly, hexagonal in shape, but not strictly so. The center canal is very small and the cell wall is very thick. The canal is quite centrally located and is more or less circular. The fiber viewed longitudinally shows the canal somewhat yellowish and when very much enlarged appears to contain granules that do not completely fill. The surface of the fiber has certain distinctive, cross-like markings which are bluish, Fig. 16.

Hemp fiber is scored crosswise with fine markings, but also carries more or less distinct markings longitudinally. Hemp is characterized by certain small "spicules" that branch off

Fig. 16. Fig. 17. Fig. 18. Fig. 19. Fig. 20.

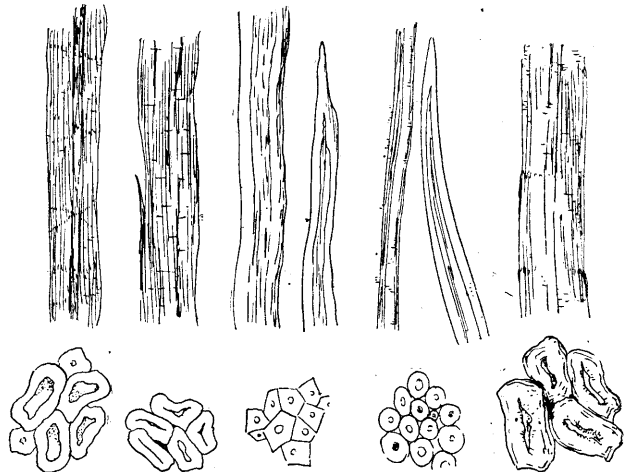

Characteristic Points of Bast Fibers.

from the outside of the fibers. The fiber tips are more or less blunt. In cross section, after treatment with Vetillard's reagent, the fiber wall is bluish, but the central portion,—that portion next to the canal—has a very much deeper coloration, Fig. 17.

Jute, on the contrary, has a large canal and when viewed in cross section, the shape is very angular. Lengthwise the canal appears very distinct. The tips of the fibers are somewhat blunt, but not nearly as blunt as hemp. The color reaction with the iodine solution is yellow, Fig. 18.

New Zealand hemp, occasionally met with in the manufacture of cordage, is a fiber that is small in diameter. In cross section it is devoid of any angular shape. The cell wall is moderately thick. Many of the fibers appear to contain granules in the central canal. The fibers do not appear to have been compressed together as the other previously mentioned fibers have been. There are transferred scorings on the fiber. The tips are somewhat pointed and resemble the flax fiber in this particular. The color reaction with Vetillard's reagent is yellow, while the granules in the canal, when present, are brownish, Fig. 19.

Ramie or China Grass differs very materially from the other fibers when viewed in cross section. The fiber appears to be somewhat compressed together and shows distinct layer markings. The center canal is not smooth, but rather rough, and contains granules. The tips of the fibers are blunt. The coloration, due to the action of Vetillard's reagent is bluish, inclining somewhat to a gray. The canal contents, when present, are brownish. Ramie is distinguished by its large cross section, Fig. 20.