

GREENWOOD & BATLEY, Ltd.

**Albion Works,
LEEDS,**

MAKERS OF THE
MOST IMPROVED
PATENTED MACHINERY

FOR ALL DESCRIPTIONS OF

Waste Silk, Ramie,

AND OTHER FIBRES, including :

Softening, Washing, Dressing and Combing ;
Single or Intersecting Screw Gill, and Rotary Gill
Preparing Machinery,

Spinning, Twisting, Cleaning, Reeling and
Bundling Machines.

RAMIE (Rhea)

CHINA GRASS.

THE NEW TEXTILE FIBRE.

All about it.

A Book for Planters, Manufacturers,
and Merchants.

BY HERBERT A. CARTER.

THE TECHNICAL PUBLISHING CO. LIMITED,

55 AND 56, CHANCERY LANE, LONDON, ENGLAND;

D. VAN NOSTRAND CO., 25, Murray Street, and 27, Warren Street, New York

E. W. COLE, Sydney, Adelaide, and Melbourne, Australia;

Geo. ROBERTSON & Co. PROPRIETARY LIMITED, Melbourne, Sydney
Adelaide, and Brisbane;

CENTRAL NEWS AGENCY, Capetown, South Africa;

GORDON & GOTCH, Australasia;

Z. F. MARUYA & Co. LIMITED, Tokyo and Yokohama, Japan
and of all Booksellers.

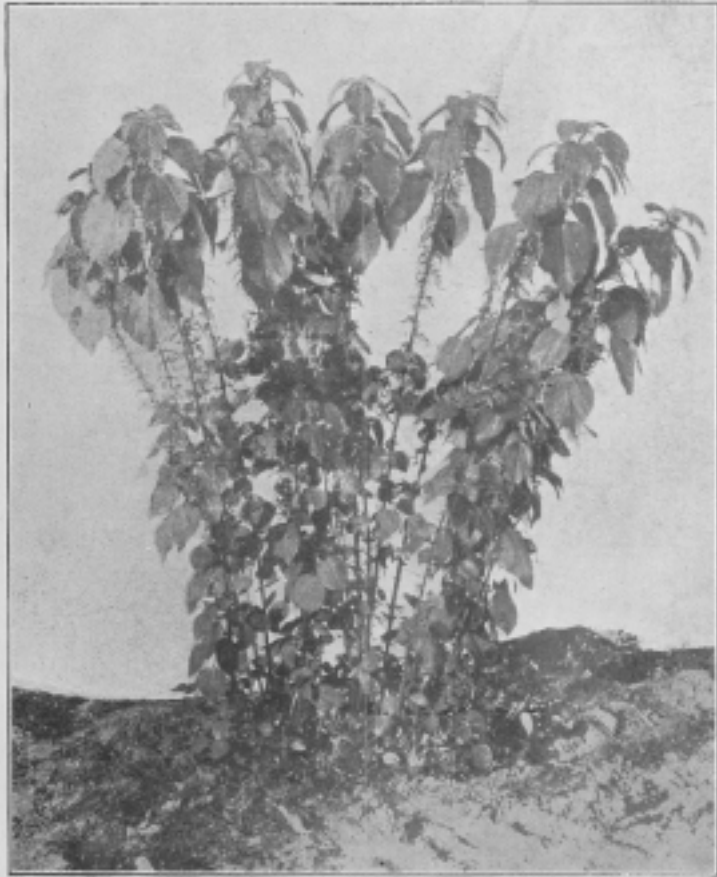

THE RAMIE (RHEA); OR CHINA GRASS, PLANT.
(OVER-MATURED.)

PREFACE.

The attention which has been so widely given for some years to the valuable textile fibres contained in the stems of the Ramie, China Grass, or Rhea plant, and the great increase which has arisen in the spinning and weaving of the same in Europe and the United States of America, has created the need of a text book upon the subject for the use of planters, manufacturers, merchants, technical students, and others.

In this book no pains have been spared to make its contents give a full, and at the same time an accurate, account of the present position and future prospects of this new textile industry, so that it may prove of real value to those who make use of it.

The author desires to record his best thanks to Messrs. Greenwood and Batley, Ltd., Engineers, Leeds, who, while not connected with him in the authorship or publication of the book, or in the matter contained therein, have kindly allowed him the use of blocks for the purpose of illustrating Ramie machinery, and to acknowledge his indebtedness for much valuable information upon the subject to the Economic Products Department of the Government of India, Calcutta; The Agricultural Research Institute, Pusa, India; the Department of Agriculture, Washington, U.S.A.; Mr. Thos. Barraclough, London; and others. He hopes its publication will have the effect of making the great merits of Ramie more widely known, and the peculiarities of its manufacture better understood.

HERBERT A. CARTER.

LONDON,
1st March, 1910.

CONTENTS.

	Page.
CHAPTER I.	
The Ramie Plant : Its Varieties.....	1
CHAPTER II.	
Soil and Climate essential for Ramie Culture.....	7
CHAPTER III.	
Ramie Cultivation—Method of Planting and Gathering the Crop—Yields Obtainable—The “ Bon ” or “ Ban ” Rhia or Rhea	12
CHAPTER IV.	
The Decortication of Rhea or Ramie Fibre.....	65
CHAPTER V.	
Method of preparing Ramie Ribbons for the Market.....	80
CHAPTER VI.	
De-gumming Ramie or Rhea.....	83
CHAPTER VII.	
Preparing and Combing Rhea or Ramie.....	87
CHAPTER VIII.	
Drawing, Roving, and Spinning Ramie and China Grass, Twisting, etc.	89
CHAPTER IX.	
The Weaving, Dyeing, Printing, and Finishing of Rhea, China Grass, or Ramie Fibre.....	99

	Page.
CHAPTER X.	
Ramie, Rhea, and China Grass in Great Britain.....	101
CHAPTER XI.	
Ramie, or Rhea Fibre, on the Continent of Europe.....	108
CHAPTER XII.	
Ramie, or Rhea Fibre, in the United States of America....	114
CHAPTER XIII.	
Ramie in South Africa.....	119
CHAPTER XIV.	
The Uses to which Ramie, Rhea, and China Grass Yarns can be put to in Trade.....	121
CHAPTER XV.	
How to Manufacture Rhea, or Ramie Fibre, or China Grass profitably	128
CHAPTER XVI.	
Ramie Cultivation in China, and the Chinese Grass Cloth Industry	133

ILLUSTRATIONS.

	TO FACE PAGE
The Ramie Plant	Title
Raw Fibre, Degummed, Cleaned	48
Lehmann's Decorticator	66
Faure's Decorticator	68
Faure's After Treating Ramie Stems	70
Faure's Large Type Decorticator	70
Faure's Working on Ramie Stems in Setts	72
A Field of Decorticated Ramie Drying	74
Hydro-extractor for Ramie	84
Boiling Keir for Degumming Ramie Fibre	86
Large Filling Engine for Ramie	92
Patent Flat Dressing Frame for Ramie	94
Intersecting Screw Gill Spreader for Ramie	94
Intersecting Sett Frame for Ramie	94
Open Screw Gill Sett Frame for Ramie	94
Open Drawing Frame for Ramie	94
Open Screw Gill Spreader for Ramie	94
Rotary Gill Drawing Frame for Ramie	94
Screw Gill Roving Frame for Ramie	94
Doubling Roving Frame for Ramie	94
Rotary Gill Roving Frame for Ramie	96
Wet Ring Spinning Frame for Ramie	96
Turning and Fluting Machine for Rollers for Wet Ramie Spinning Frame	96
Dry Ring Twisting Frame for Ramie	96
Cleaning and Gassing Frame for Ramie	96
Power Reel for Ramie	96
Bundling Press for Ramie	98

RAMIE (Rhea), China Grass.

CHAPTER I.

The Ramie Plant: Its Varieties.

DURING late years much has been written respecting the urgent need of flax substitutes, and of new fibres of proved value generally for textile manufacturing purposes, and it is recognised that the spinner and manufacturer who is desirous of making profitable progress in his business is bound to direct his attention to the same to a greater or less degree. Failure on his part to do so is certain to result to his disadvantage, even though he is not actually engaged in spinning or weaving any of these new fibres, or experimenting with them in order to render himself, at any rate to some extent, conversant with their characteristics and the peculiar needs of their spinning and weaving. Chief amongst those vegetable textile fibres which have thus attracted attention must be named the fibre extracted from the stems of the Rhea, Ramie, or China Grass plant.

Ramie, known in India as "Rhea," and when cultivated and hand cleaned in China called "China Grass," belongs to the family of *Urtica*, and to the sub-division *Boehmeria*. There are many varieties of the plant, but the two which have been found to be the best fibre-yielding species are *Boehmeria tenacissima*, often called the green-leaved ramie, and *Boehmeria nivea*, often called the white leaved ramie, on account of the silvery appearance presented by the under sides of its leaves. The *nivea* species is mostly grown in China, India, and Formosa, and the *tenacissima* in Java, Sumatra, Borneo, Malacca, Mexico, and other

tropical countries. From time to time attempts have been made to successfully cultivate the plant in temperate zones, and at one time great hopes were entertained of this proving possible in France, Holland, and other countries enjoying a similar climate, but they have not been realised, as the plants are unable to withstand the cold of winter unless protected to such a degree, and at such an expense, as to cause their cultivation to be too costly.

In modern commerce rhea and ramie are the vernacular names ascribed to the decorticated ribbons of fibrous bark, and China grass assigned to the unbleached though more or less clean fibre. Rhea, or reeha, riha as it should be written, being the name by which the plant is known in India, might with advantage be given to the Indian produce; and ramie, or rami, being the Malayan name, might be restricted to the produce of the Malay Archipelago. Sir George Watt, Adviser on Economic Products to the Government of India, says: "It seems an error not only in fact but very possibly in the textile merits of the products concerned to speak of the Indian and Malayan fibres as rhea, or ramie (rami). These names are neither synonymous nor are the fibres in all probability derived from the same plant. It would be more in accord with the actual state of affairs to speak of rhea and China grass conjointly, but distinct from ramie, or rami as it is sometimes written."

"Chu-ma" (Tchow-ma) is the Chinese name for the plant. "Cay-gai" and "Pa-ma" are given to it in Cochin China. "Kankhura," or "Kankura," is its most general Bengal name, but in Bogra it is called "Kund," and in some parts of Jalpaiguri the name "Kurkunda" is given to the plant. "Reeha" (Riha) is its Assami name, and "Risa," "Rusa," and "Sumsha" are given to it in the Naga country. In the lower portions of the Valley of Assam, such as at the foot of the Garo Hills, and in Kamrup generally, it is known by its Bengali name "Kankúra." It is called "Pan" in the Shan States, and "Gun" or "Gwôn" in Burma. In Assam no cultivator of the plant would

recognise the word rhea. It is "riha," *i.e.*, pronounced "ree-ha."

It is of primary importance if rhea and ramie fibre are to be utilised profitably in commerce that the names by which the plant is known by the natives in those countries in which it is cultivated should be ascertained, otherwise difficulties will arise in obtaining raw supplies, for it is by no means certain that instructions sent to these growing areas for the purchase of the same can be easily carried out if the words rhea, or ramie, only are made use of by the spinner in transmitting these to Calcutta and other centres.

Rhea is not a native of India, nor even an acclimatised wild plant; on the other hand, there are three or four species of indigenous nettles, all more or less allied botanically to rhea, or ramie, but which are not species of *Boehmeria*, that are well known to yield valuable fibres, and they are plentiful and widespread. One of these is by the hill tribes of Assam universally designated the "Bon" (or "Ban") Riha. This plant is the "*Villebrunea integrifolia*," and the natives distinguish this as the true "ban-riha," rhea, or ramie. It yields a fibre of great merit. It is presumed, and it is highly probable, since the family resemblance between the two, *Villebrunea* and *Boehmeria*, seems fairly generally recognised, that *Villebrunea* is the original rhea, or "riha," of Assam, and that *Boehmeria nivea* was carried across the Chinese frontier, and introduced to the cultivators of the plains, being named by them "rhea," while the wild plant then became spoken of as the "Bon," "Ban," or Wild Rhea, or Riha. The original tribes, it is stated, have fully appreciated the properties of the ban-riha, and been able to spin and weave it, while their more enlightened neighbours of the plains can only spin the riha into string and make fishing nets from it. This fact seems to indicate a greater antiquity for the knowledge of the textile properties of the wild as compared with the cultivated plant.

Boehmeria nivea is a herbaceous sparsely branched plant, with thick, succulent, softly hairy stems. Leaves

broad, ovate, the apex acuminate, the margins coarsely dentate-serrate, and the base truncate and only slightly drawn out into the petiole, but hardly ever showing any tendency to be cordate. The veins in the lower half of the leaf are distinctly three, the midrib becoming pinnate above the middle. Under-surface felted uniformly all over with silvery wool, in which only the midrib and the primary (or at most the secondary) veins show through the felted surface, and bear scattered thick hyaline hairs. Stipules large, and persistent. Inflorescence mostly much shorter than the petioles, thick, and crowded with clusters of flowers.

The Malayan plant *rami*, or ramie, is a more robust form than *Boehmeria nivea* (rhea), already described. The leaves are of a thinner and smoother texture than in *Boehmeria nivea* proper, and with the petioles considerably longer, more slender, and hairy. The blade is ovate, distinctly cordate even in the oldest leaves—that is to say, it has the base produced into rounded lobes so that the sinus gives origin to a pronounced elongation into the petiole. Veins of the lower portion often five, owing to a pair of slender ones lining the margins of the sinus in addition to the three very prominent main veins. Under-surface of young leaves hoary, but with open or loose white wool, which, as the leaf expands, partially separates from the texture, and becomes collected within the meshes of the ultimate reticulations. This gathering together of the tomentum gives the leaf a mottled appearance. The veins, as also the most minute reticulations (on both surfaces), are freely coated with longish, stout, spreading hairs that often assume (more especially on the under-surface) a slightly rufous tint. Owing to the tomentum being collected together, the veins and reticulations in this form show up very distinct, and destroy the uniformity of the white-felted coating that is so characteristic of the typical condition of the species. Stipules relatively small. Inflorescence usually longer than the petioles; at the same time more lax and more profusely branched than in the typical state.

The fibres yielded by rhea, China grass, or ramie

are contained in that part of the stem which lies between the outer bark, or cuticle, and the inner woody core, where they are embedded in various gums and resins, surrounded by the outer bark or "cuticle." The plant was described for the first time under the name of *Ramium Magus* by the Dutch botanist Rumph, who discovered it about the year 1690 in the island of Banoa, and specimens of the plant were brought to Europe late in the eighteenth century, when the fibre first became known to commerce. Dr. Buchanan Hamilton was, there is but little doubt, the first authentic discoverer of *Boehmeria nivea* in India, when he found it in certain villages in Bengal in 1807. He gave it, in 1808, the vernacular name of "Kankhura," and said it was an *Urtica*, and possibly *nivea* of Willdenow, and it may be remarked that Sir George Watt, with the permission of Prof. Balfour, of Edinburgh, has within recent years examined Dr. Buchanan Hamilton's No. 2,013, collected on the 8th November, 1808, at Goalpara, and that it is typical *Boehmeria nivea*. There is no specimen, however, he adds in his herbarium from Dinajpur.

The fibres of ramie, rhea, China grass, and also those of the "Bon," "Ban," or Wild Rhea, or "Riha," are of great strength—a strength very much greater in fact than that of any other fibre,—remarkable fineness, and they possess a lustre almost equal to that of silk, superior indeed to that of the lower qualities of silk. The fibre of *Boehmeria tenacissima* is not quite as fine as that of *Boehmeria nivea*, but it is somewhat stronger. It spins well into yarn, but as the filaments are not so fine the yarns cannot be spun quite as fine as those of the white variety. *Boehmeria nivea*, on the other hand, although not quite so strong as *Boehmeria tenacissima*, has the advantage of being able to be spun into somewhat finer yarn, a little more careful treatment in the manufacturing operations being, however, necessary. It is considered to have a better colour than *Boehmeria tenacissima*, which is a further point in its favour. The difference in the relative filament length of the two descriptions is not great, and no fibre can be compared to them in regard to strength. Some

manufacturers make use of the one, some the other description, partly from choice and partly from custom, due to the fact that they have become more familiar with, and perhaps more successful in, the treatment of one than the other. Both fibres have the same degree of silky lustre.

Ramie does not bring forth its full product until the third year of cultivation. It is only when the sub-soil of the field is permeated with their roots that the plants throw out the numerous shoots and yield the quantities of stems observed with the best crops.

The fibre is a pliable one, which renders it well suited to compete with flax. Its length varies from .088 of a yard to 2.10 yards, according to the favourable or unfavourable latitudes in which it is grown.

Regarding the form of plant now met with in Indian cultivation, and the botanical specimens preserved in the Calcutta Herbarium, most Indian writers on the fibre, following Roxburgh and the majority of systematic botanists in India, Europe, and America, have regarded the Indian plant as being *Boehmeria tenacissima*. As an example, Mr. C. B. Clarke, writing so late as the 16th June, 1870, at which time he was Officiating Superintendent of the Royal Botanic Gardens, gave it as his opinion that "the particular cultivated race known as rhea in Bengal is the plant named by Roxburgh *Urtica tenacissima*, and is generally considered by modern botanists to be a mere variety arrived at by long cultivation from *Boehmeria nivea*." This was in a letter addressed to the Secretary of the Government of Bengal. Mr. Clarke thus apparently regarded the cultivated plant of China, India, and the Malay as identical, and to be *Urtica tenacissima* (Roxburgh), the wild plant being *Boehmeria nivea*. Sir George Watt, however, says that explanation must now be accepted as dispelled, for as already stated the Indian plant is persistently Chinese. Throughout India, wherever rhea cultivation is pursued, under sub-tropical and tropical conditions alike, the cultivated fibre-yielding plant is *Boehmeria nivea*, never *Boehmeria tenacissima*. It varies within certain limits. The marginal serrations

are at times minute and pointed; at others, coarse and quite dentate in shape. The petiole is mostly short and thick; at others, long and slender. The base is usually rounded, or almost truncate, but in some instances is more or less drawn out; it only very exceptionally becomes cordate—that is to say, it has no sinus, nor any attempt at rounded auricles. For the most part the leaves are thick, and the woolly coating copious, but it is found that in neglected cultivation this greatly diminishes, and becomes thinner and less woolly. It is at all times uniformly distributed (not mottled), and the undersides never become entirely green.

CHAPTER II.

Soil and Climate Essential for Ramie Culture.

THE growth of the plant, its production, and the quality of the fibre which may be obtained from it vary greatly according to climatic conditions, soil, mode of cultivation, and treatment of the fibre. The first essential to the soil for ramie culture is warm moisture the wet lands on which rice and jute are grown are not suitable to the fibre's growth, and anything like stagnation of water on the land, even if it be but for a short period, will destroy a plantation. A good supply of water at all times in the soil, and ready absorption of all rain that falls, are requisite in the land. The soil on the surface should be friable to take in the moisture, and the sub-soil porous so as to absorb the excess of water or heavy rains. The land should be at such an elevation that no danger will exist of damage to the crops by reason of floods. Moisture and warmth in the land are to a great extent dependent upon moisture and warmth in the atmosphere, so a plentiful rainfall is essential, together with a high and even temperature. The rainfall requires not only to be plentiful, but also well distributed throughout the year; and it has been found in India that the plant cannot be grown profitably where the rainfall is less than 45 inches. Drought is the greatest enemy of ramie after stagnant water. Dry

heat has the effect of drying it up; drought kills it at once; in brief, what suits the fibre is a naturally deep soil, a rich sandy loam, plenty of rain, and no extremes of temperature. It is only in countries where continuous growth can be secured that ramie can be grown advantageously. The fibre might be cultivated anywhere, but it is impossible to have a paying crop in England, because only one crop could be obtained in the year. When once planted rhea, or ramie, will last for thirty or forty years, and three months after being planted a crop can be reaped. The area in which it can be most successfully cultivated is within 10 or 15 degrees north or south of the Equator. Land on which other crops have been grown should not, if possible, be chosen by the cultivator. Jungle land should be very suitable. The author has succeeded in the North of England in obtaining in open cultivation one good annual crop of fibre-bearing stems, with slight care, save occasional manuring of the land. The plant is a hardy perennial—that is, its roots do not perish annually like those of flax, but, on the contrary, grow stronger, and strike down into the ground deeper and deeper year by year, and it can be propagated by means of seed, roots, or suckers. From three to six annual crops of fibre-yielding stems may be obtained in cultivation in suitable areas, and the plant grows to a height of about six feet. In China rhea, under the name of China grass, is cultivated very extensively for fibre purposes, and many thousand tons are exported yearly to Europe for the purposes of treatment and manufacture.

In British India rhea, or ramie, is cultivated generally as a garden curiosity, and also all over Burma. It occurs in these countries purely and simply in a state of garden, and it might be said small field, cultivation, and is grown by the people of India as a fibre plant in about six districts of Northern Bengal, throughout the greater portion of the extensive valley of Assam, and in the Shann States of Burma, and a very fair measure of success has attended its cultivation by European enterprise in the Kangra Valley, in the Punjab. It was at one time generally supposed that rhea could

be successfully grown all over India. This, however, is not so. In districts possessing a soil and climate in accordance with the requirements which have been already named, any quantity of rhea, or ramie, can be produced, and experts are agreed that if the authorities will foster and protect the cultivation, India will become one of the most important rhea-producing countries. The plant is one which becomes more and more productive each year of its growth, and even in abandoned cultivation it has continued to thrive and yield good fibre crops for many years. If grown from seed it yields a crop the first year, and if planted from root cuttings it can give two crops in the first year. The bark contains a quantity of tannin, and the plant is accordingly singularly free from insect pests and fungoid diseases. In the Straits Settlements it has been estimated that from each acre cultivated three-quarters of a ton of fibre might be obtained the first year, and in the second year, when the plant was absolutely matured, two tons of fibre per acre secured. The minimum yield of fibre from each stick is four to five per cent. The Bureau of Plant Industry, Washington, U.S.A., say possibly six per cent. The climate of the Straits Settlements, it may be observed, is one which has the advantage of being the same all the year round, and the Straits have often been named as an ideal area for rhea cultivation on this account and shipping facilities. There is, however, a difference of opinion on this point, and while certain persons who have grown the fibre in this locality claim to have achieved more than an ordinary amount of success in its culture upon something more than an experimental scale, others resident in the Colony state that they found it impossible to grow it remuneratively. The author may remark that some years ago he received a letter from the representative of a German firm who were engaged in degumming and spinning ramie, in which this gentleman observed that, having travelled the district and tested the soil, he was doubtful as to ramie culture proving a commercial success in the locality; yet the opinion of the majority appears to be that it should prove a good growing area.

Ramie, by reason of the height to which it grows, could be cultivated to serve the purpose of hedges on plantations generally, and the same could be cut down and sold by the planter, say, twice in the year, the growth of the plant being made in this way a source of profit.

In ramie cultivation one hundred tons of plant must be obtained to yield six tons of fibre. At first this seems a very large quantity to be necessary to obtain such a return, but it may be borne in mind that the growth of the plant in suitable soils and climates is very prolific, and its stems and leaves weigh pretty heavy. Although the plant will grow, or to be more precise exist, in very poor soils, the results obtained in cultivation will always be found to be in accordance with the amount of care bestowed upon it and the quantity of food which it receives in the form of easily assimilated manure, and in regard to Indian cultivation, were a large steady demand to arise in Europe and the United States, the opinion is that production would instantly respond. The obstacles which to some extent exist to the preparation of a clean fibre would rapidly vanish, if they may not be said to have disappeared very largely already. What is wanted is a remunerative demand. So soon as the manufacturer finds, as he now appears to be doing in France, Germany, the United States, and in Great Britain, that there is a fairly large and distinct market for ramie textiles, and is able to give something in the nature of a guarantee to the grower, the difficulties attending large production will cease. The spinning of the fibre would be very much more extensive to-day than what it is but for the fact that the manufacturer has, up to within recent years, held the view that not having obtained the assurance of a continuous adequate raw supply he was not justified in building special mills for spinning ramie. The grower in India, on the other hand, considering up to lately that the fibre had not yet secured a definite position among textiles, regarded the market as one which could only be considered as limited, and so he would not cultivate on a large scale, as he considered himself in the hands of the manufacturer, to receive

from him for his produce whatever price he felt inclined to offer without any certainty of its yielding him a fair profit on cultivation. It is, as a result, from China that existing ramie mills receive almost the whole of their supplies, and as there is a good demand for China grass, or rhea, in that country for spinning and weaving purposes, the export trade to Europe evidently pays the cultivator well—in fact, very well,—and he frequently advances his price for the product, although not so often, nor so largely, now as he did some years ago. This naturally has its effect on the volume of trade done in the fibre each year. Ramie has, however, within the last few years, established a firm footing for itself in the manufacture of various special classes of goods which places a different aspect on the situation.

In the province of Assam the riha shawl of Assamese ladies is not made of China grass, or rhea. It is a silk gauze, or a mixed silk and cotton gauze, or in the case of the poorer classes an unbleached cotton gauze, but in every instance it is stated to be a fabric woven in the peculiar manner best described by the term gauze, and it most unquestionably recalls the appearance of the fine grass cloth muslins, or gauzes, of China. One of the most surprising features of the riha, or "Kankura," industry of India may, in fact, be stated to be the circumstance that the fibre is nowhere woven into fabrics, but is utilised for the purposes of fishing line and net making and cordage. It has been prepared for many years at Bhagalpur, in Bengal, by families of the Dhanook caste, specially for the silk weavers there to weave mixed with silk, and the fibre of the bon riha, or wild rhea, is also used for the purpose of making nets, and in certain cases for mixing with silk. The suitability of the fibre for weaving in combination with the latter would therefore seem to be appreciated by the natives in India as well as by European manufacturers. Its extraordinary length of filament, which amounts to 14 and even 16 inches, so enabling it to be spun into very fine yarns, with the minimum of twist, without destroying its

fine lustre, renders it pre-eminently fitted for being advantageously used in this manner. Ramie is the longest of all textile fibres: its filaments range in length from $2\frac{1}{2}$ in. up to 18 in.; those of flax vary in length from $\frac{1}{8}$ in. to $2\frac{1}{2}$ in. It is also the strongest fibre known. The comparative tensile strength of some of the leading fibres may be known as follows: Taking the strength of ramie to be 100, the strength of hemp is 36, flax 25, silk 13, and cotton 12. Its brilliancy and lustre are superior to those of all other textile fibres, and in these respects it may be compared with silk itself. In certain classes of goods it is only an expert who can distinguish between the ramie and the silk. This has proved particularly to be the case with mixed fabrics manufactured in England, and it may be said that up to the present time the most perfect substitutes for natural silk, and at the same time the cheapest, produced from rhea, China grass, or ramie have been woven in Great Britain.

CHAPTER III.

Ramie Cultivation—Method of Planting and Gathering the Crop—Yields Obtainable—The “Bon” or “Ban” Rhea or Rhea.

THE good qualities of ramie as a textile have long been known, and even so far back as 1853, while the jute industry was only in its infancy, they were urged upon manufacturers in Dundee to no purpose. That the merits of the fibre were then overlooked, however, may be set down to the fact that while the possibilities of jute lending itself easily and profitably to culture, spinning and weaving, had been endorsed officially by the Government of India, the difficulties which beset the separation of rhea fibre were deemed to be unsurmountable in an economical manner, and moreover the peculiarities of the fibre were not studied and taken into careful consideration in the efforts which were made in a few cases to manufacture it. An absolutely new fibre requires a new method of treatment, and

special plant and machinery. The preparation and manufacture of cotton, wool, flax, jute, and silk to-day are the outcome of the inventive talents and the efforts of a large number of persistent and painstaking men, extending over many years. The peculiarities of each of these textiles have been carefully investigated, and mechanical and other methods necessary to deal with them in an effective and economical manner have been elaborated, tested, and perfected, so that the machinery and plant now in use are thoroughly well suited to all the various peculiarities of each fibre, and the needs of each trade, and class of goods. The desire of manufacturers interested in these textiles to possess the best machines for manufacturing them stimulated inventive genius, and brought about a persistent study of their mechanical and other requirements, which eventually caused the difficulties, one by one, to disappear, until the maximum quantities of superior and varied descriptions of materials were enabled to be produced in a given time with the least possible manual labour, owing to the employment of machines constructed to work as automatically as the competitive efforts of machinists could possibly devise. Such a concentration of studies upon the one subject could not fail to bring about the satisfactory results which we enjoy the benefits of to-day, and the inventive minds of the United States and the textile manufacturing countries of Europe vied with each other during this period in making these possible.

It was not until the year 1869, or nearly twenty years after the date when the merits of ramie were urged upon Dundee manufacturers for the first time seriously, that the Government of India took steps to endeavour to turn to profitable uses the fibres of the rhea, or ramie, plant, which, it had been made evident to them, could be cultivated successfully in certain districts of the country, and a bonus of £5,000 was then offered for a process, or machinery, capable of producing by the aid of animal, water, or steam power a ton of fibre from the stems of the plant, which should average in value not less than £50 in the English

market, at a total cost, all processes of manufacture and allowance for wear and tear included, of not more than £15 per ton. One year from the date of the offer of this bonus, 11th January, 1870, was allowed for the preparation of the machines and their transport to the locality named for the competition, when the trials were to be made and the decisions of the judges given. It was further announced that if no invention of sufficient merit was presented the Government would continue to allow machines to be tendered for trial until the end of two years from the same date, after which, or on the award of the prize, the offer made would be withdrawn.

This bonus may be said to have marked the commencement of the almost ceaseless activity which has since been shown by the chemist and machinist in Europe, the United States, and in India itself to arrive at a satisfactory solution of the problem. With respect to the outcome of these machine and process trials, which were duly held at Saharanpur, further and full particulars will be given in a later chapter. Suffice it, for the present, to say that the more marked attention which was directed to the fibre during the continuance of the American Civil War, when a general scarcity of textile fibres was experienced by manufacturers, was further greatly and widely increased, and at the same time that the question of the extraction of the fibre for spinning and weaving came up prominently for consideration, and attention was more closely concentrated on the problem as to where and how the plant could be best cultivated for fibre purposes.

The question of raw supply is of primary importance in all manufacturing industries, and it is needless to say that in considering what are the prospects of establishing an industry upon a solid, lasting, and profitable basis, it is necessary, so far as the manufacturer at his end is concerned, that this should be adequate in proportion to his requirements, regular in quantity, and obtainable at prices which will enable him to make such a profit as justifies him in sinking his capital and devoting his energies in carrying it on.

Reference has already been made to the prospects of successful ramie culture in the Strait Settlements. The following extract from a letter addressed by C. Curtis, Esq., F.L.S., Forest Department, to Surgeon-Major D. Prain, M.A., M.D., F.R.S.E., dated Penang, the 20th October, 1897, is of considerable importance in its bearing on the subject from three points of view: First, it emanates from a responsible source; secondly, it is of comparatively recent date; thirdly, it affords reliable information on the important point as to the period that must transpire between the time of sowing of the rhea, or ramie, seed (if we determine to accept the latter designation as being a correct name to give to the Indian plant, and take it that in commerce by so doing we are dealing with what is one and the same plant yielding to all practical intents and purposes the same fibre, although there exist in cultivation two varieties of *Boehmeria*—viz., *nivea* and *tenacissima*.—a fact which, it must be borne in mind, has not so far been absolutely disproved) and that of gathering the initial crop of stems from the seeds thus sown.

“I am fortunately able to answer your very practical question on ramie.

“On the 12th February this year I sowed some seeds of ramie in a carefully prepared bed of light soil, with protection from sun and rain. On the 2nd March the plants were four to six inches high, when they were lifted and put in pots. A month later they were planted out in a bed, and the first cutting was made in August. This gives just exactly six months from seed sowing to cutting. I had a look at them again this morning. They completely cover the ground, and are ready for cutting a second time. This is a form that grows about 4 feet and begins to flower early—in fact, the stems are full of flower now.”

This appears to confirm to a great extent the opinion held by many authorities that the Straits Settlements is a favourable area for ramie culture. The growth from seed to maturity in this instance occupied only six months, and it would seem that a good fibre yield per acre may with confidence be looked for from the

B

plant when it has matured, and that following its general custom a substantial increase in dry fibre can be secured in cultivating in each succeeding year.

This trial was made in Penang, and the soil would certainly appear to have been of the right nature. In the Kangra Valley, in the Punjab, seed sown in a hot bed, under glass, in March and April yields a first crop of available shoots the following spring.

As to whether the variety of the plant known in Assam as rhea, or that known as ramie in the Eastern islands, is identical with the Chinese plant, Mr. Montgomery, who cultivated the fibre at Ram Bagh in the Kangra Valley, in the Punjab, says, in a report to the Government of India, to which reference will be made later, "I do not venture to offer an opinion. The Government of India have apparently adopted the former appellation 'rhea' in designating the fibre; the American Government have adopted the latter 'ramie.' I have not had an opportunity of comparing growing plants of mine, but I have had many specimens of fibre from each supplied to me, and there appear to be well-marked distinctions between the three in colour and texture of the fibre." Very great weight must be attached to Mr. Montgomery's remarks, owing to the fact that he not only cultivated the fibre for a fair number of years, but did so upon a commercial scale, and they appear to bear out the opinion expressed by Sir George Watt, that the plants are distinct, and that the fibres which they yield differ. This difference, however, would only seem to be slight, as shown by the manner in which they spin and weave, reference to which has already been made, and to lie in the fact that the fibre of *Boehmeria tenacissima*, while rather stronger than that of *Boehmeria nivea*, is not quite so fine, nor can it be spun into as fine yarn as can that of *Boehmeria nivea*, provided the latter receives somewhat more careful treatment in the manufacturing operations. From this circumstance it would strongly appear that the conclusion which, without any error, can be drawn is that the fibre of *Boehmeria tenacissima* would lend itself better to the production of a strong bleached

cloth than that of *Boehmeria nivea* when treated by some degumming processes, in which the technical skill of the chemist has not been exercised to the same delicate and exact degree as in others, although at the same time it would fail to produce yarns and fabrics of as fine a quality, consequently of as high a value in a monetary sense in commerce. In other words, the manufacturer under such processes would be safe to make his profit on a large production of comparatively coarse yarn, while he might be quite unable to make the same profit on a lesser production yearly of specialised fine yarns or fabrics, or of ramie, or China grass, yarns for weaving mixed with the finer qualities of flax, or silk, or maintain his position against those of his competitors who, by reason of the possession of superior degumming processes, might be able to do so with a less large factory than his. Probably failures to manufacture the fibre profitably within recent years, comparatively speaking, in one or two cases in England and on the Continent have arisen; if this is really so in processes adapted for the degumming of *Boehmeria tenacissima*, of which limited supplies only were obtainable, being set to treat *Boehmeria nivea* imported from China, for but a slight degree of over-treatment of the fibre in its degumming causes it to deteriorate in strength when it is in the piece-goods state submitted to bleaching preparatory to being placed on the market for sale in the white condition, or dyed. Many processes have, however, been set working in past years which would neither extract *Boehmeria tenacissima*, nor yet *Boehmeria nivea*, in such a manner that when woven into cloth it would stand the process of bleaching without going weak in strength, a circumstance which has thrown a cloud over the inherent good qualities of the fibre, from which it has only of late begun to unmistakably emerge. A sound process should deal successfully with both these varieties, and also the fibre of the "Bon," or Wild Rhea, either in the condition of the ribbon, or strip of fibre-yielding bark just stripped from the stem of the plant, or machine, or hand cleaned, or decorticated fibre.

We have already stated our authority for saying that the Indian plant is most distinctly Chinese—viz., *Boehmeria nivea*,—and the manufacturer using a sound degumming process may be naturally concluded to look to India and China for his raw supplies as being capable of yielding him the best yarn for either coarse or fine goods. The methods adopted for cultivating the plant in India may now be considered, and the yields of stems obtainable per acre of land cultivated, and in relation to *Boehmeria nivea*, the Indian plant, a very important statement, and one deserving of notice, is made by Mr. Hosie, His Majesty's Consul, at Wemchow. He says: "Although only one form of *Boehmeria* is cultivated round Wemchow, China—namely, *Boehmeria nivea*—I notice that this plant as soon as it strays from cultivation, as when seeds have been carried by the winds into loose stony walls, or on to poor soils, the silvery white under-surfaces of the leaves quickly disappear, and give place to green with white, or rather flesh-coloured veins, while the stems assume a brownish colour." Under these circumstances this species of the plant assumes the characteristics of *Boehmeria tenacissima*. In neglected cultivation in India the leaves become smaller, thinner, and the silvery tomentum much less dense, but it is stated it never entirely disappears and gives place to a green texture with coloured veins. So far as India is concerned *Boehmeria nivea* neither exists as a wild plant nor as an escape from cultivation, and will only survive for a few years on being abandoned. Watt says all the herbarium specimens seen by him that have been collected in China have manifested in a remarkable degree of constancy the condition of the species as already indicated, and he has practically met with no instance among a wide series of any very distinct tendency to approach the Sumatran form, though in cultivation he believes hybrids are by no means rare. It has been suggested, and very wisely, the author considers, that being a more tropical form the Malayan plant would very possibly be found better suited to India than the Chinese, and that European planters who may contemplate an extended culti-

vation should experiment with both forms. It has often been found that in Europe the cleaned fibre (China grass) fetched a higher price than the corresponding fibre from India. This was by many supposed to be due to the fact that in India the plant cultivated (as Roxburgh and many subsequent writers had affirmed) was *Boehmeria tenacissima*, and not *Boehmeria nivea*. We now know that if the Chinese fibre is actually superior to that obtained from India the fact must be accounted for by its being supposed that in India the plant does not afford a fibre of quite the same quality as in China, or that the Indian method of separating and cleaning the fibre is deficient to that pursued in China. The latter circumstance is probably the correct view to take, as the cultivation of the fibre for textile fibre purposes in China has a more remote origin, and is very much more general than in India; and long practice has made the Chinese thoroughly conversant in regard to its peculiarities, and remarkably adept in its separation, and cleaning by hand. The question of the relative values of the two fibres is consequently moved from India to the Malay Archipelago. Planters should give this subject careful study in order to solve the important question, namely—which form of the plant gives the best results in adaptation to local, climatic, and other conditions.

At the present time rhea, or ramie, cultivation is generally pursued in India by the native cultivating plots, of a few yards in length and breadth, adjoining the homesteads, and it receives in this limited cultivation a much larger amount of manure, and is more carefully supervised than would perhaps be possible with a field crop. The yield varies according to the extent of the manure and supervision, and so widely that the returns given by one cultivator vary much from those given by another. It is grown, as a rule, by the actual consumer, who can at times with difficulty only be induced to put down more than he requires for his actual needs. The price offered by European and other spinners has, up to the present, failed to induce cultivation upon a large scale, and with the native the crop is

somewhat unpopular, owing to the labour involved in separating and cleaning the fibre. The Government of India some years ago withdrew their offer of a bonus for doing this work by machine instead of by hand, but it has been suggested that were a premium offered this would be better than to establish a Government experimental farm, and it would stimulate the ryots equally with the speculator.

In Dinajpur, Bengal, rhea is propagated by slips from the roots, which are planted out in the beginning of the rainy season. There are no fields of the plant, but many of the gardens contain a few beds. The rhea, or ramie, plant thrives best in the shade, and the rich fertile country from Dinajpur to Joyganj and Godalpur should answer well for its growth, as the tract is covered with bushes some six to fifteen or twenty feet in height; these would afford the shade which rhea is known universally to seek, while the soil is of the required kind—viz., a sandy loam. Dr. Buchanan Hamilton established 1,000 bighas as the area under rhea crop in 1807, though it is hardly cultivated anywhere in the district to-day. Possibly the area assigned to it in the beginning of the century may have embraced a considerable portion of what is now designated Rungpur. In this latter district rhea, flourishes well exclusively within the tobacco-growing area, and the plant is successfully grown where the finer qualities of *N. Tabacum* are produced.

If it is given the best soil, and land above inundation, and if the fields are manured and tended well, the rhea, or ramie, plant will always make a good growth. Those localities and soils that are suitable for tobacco may be taken as suitable for rhea, or ramie, also. The plant is grown round Rungpur itself, and in the following villages: Rampura, Satgara, Lalbag, Barabari, Bororghat, Shabda, Shabdapuskerni, Shampur, Ablihat, Burihat, and Jhataka (thirty miles from Rungpur), and the village of Kankurapara (in the Kurigan sub-division) receives its name from the extent to which "Kankura," or rhea, or ramie, is there cultivated. In this village there are many native cultivators, none of whom belong

to the fishing class, who grow the crop and sell the produce on the field to the fishermen, who use it for making fishing lines and nets. The plots of land devoted by each cultivator to the crop are approximate to what might be called field cultivation. Rhea, or ramie, in this sub-division may be regarded as a regular agricultural crop, a state of affairs seen for the first time at Kan-
kurapara, and not to be met with in any other place on the same scale in Bengal or Assam. At Honnaram, near Barabari, cultivation on a fairly large scale can also be found, but the plant is reported to be subject to the attacks of a caterpillar which does it much injury. The cultivators are Rajbunsis, who sell the produce to the fishermen.

Crossing the Brahmaputra river to the corner of the Rungpur district that lies just under the Garo Hills, the crop may be met with at many villages around Rohmari. Throughout Rungpur, wherever a soil of rich sandy loam occurs there ramie cultivation will be met with. In the Bogra district, from Jumarbari to Modhupur, Mokamtola, there are also many villages in which ramie, which is called "kund," is grown. Wherever there is a red clay soil, however, it is not met with, and with the disappearance of tobacco fields ramie cultivation becomes scarce, and of a very indifferent quality. In Jalpaiguri, from Talakata to Alipore and Kuch Behar, many rhea-growing villages also exist, the plant receiving the name "kurkund," not "kankura."

The native method for obtaining the fibre practised at Bhagalpur is as follows :—

The site of the small factory is chosen, if possible near a stream of soft water, as the process is one of slow boiling, or simmering, and beating in combination with washing.

The factory plant is an earthen, or other, pan or boiler, and two notched boards such as dhobies use.

The workpeople two men, two women, and two boys.

The boiler is charged with water sufficient to cover the shoots proposed to be dealt with, and to it is added about 10 chuttacks sujje matee (crude carbonate of

soda) per maund of plant placed in the boiler. The whole is then allowed to simmer, or boil, slowly for $1\frac{1}{2}$ or 2 hours.

The shoots are then taken by, or handed to, the nearest man with a notched board before him (the boards being placed near by, or partially in the water, dhoobie fashion), and in such portions as can be held firmly between his two hands he continues to dash it against the board, washing it at the same time, thus clearing each end alternately of the wood and portions of the bark and gum. The handful is then passed on to the second man with a similar board, who beats and washes it in the same way to free the filaments still further from gum and bark.

After this it is taken by the boys back to the boiler to be again slowly boiled, or simmered, for about an hour. It is then again beaten and washed by the two men as before till the gum is removed and the filaments are free.

The two women now take charge of it to be dried, beaten, and drawn, or carded, till it is in the condition of pure white fibre.

A maund of shoots per hour can thus easily be worked off, which, if filament is in the plant in the proportion of $2\frac{1}{2}$ per cent., will be one seer of fibre fit for spinning by the native hand method, or for the combing machine if sent to Europe or America. If the percentage of filament in the plant is over $2\frac{1}{2}$ per cent. the outturn will be increased in proportion, while no addition is made to the cost.

By adding half the original quantity of sujje matee to hot water in the boiler it may be used again afterwards, but the water should be changed.

White ants are a danger to the plant in India, and have to be guarded against in cultivation. They are apt to attack the woody portion of the stem left exposed after harvest cuttings, and burrowing downwards inside the roots honeycomb them of their pith, leaving nothing but the bark untouched. They eventually attack all weaker plants of all ages. Rhea, or ramie, is not indigenous to any part of the district, but can

be cultivated everywhere with more or less care. The plant must be protected by fences from the inroads of cattle. The most hopeful prospect of a future expansion of ramie culture, Sir George Watt states, may be said to lie within its present area in North Bengal, and the overflow may be looked for to pass east and north-east into the Valley of Assam, rather than go to the southern and south-western or south-eastern districts of Bengal. Its suitability to the Rungpur and Jalpaiguri districts, and to the Duars, points to a possible expansion westwards towards Tirhut, or it seems as if Indian ramie cultivation may become distributed within the belt of districts which, starting in the extreme east, north-east in Lakhimpur, and passing through Sibsagar, Darrang, Nowgong, Kamrup, Goalpara, Kuch Behar, Rungpur, Jalpaiguri, and the northern extremity of Dinajpur, pass still west to Purneah, Bhagalpur, Durbhanga, and Champaran, and possibly also to Saran. No difficulty would seem to exist against an eastern distribution except, perhaps, the labour system, which is somewhat serious in Assam. Rungpur lies right in the centre of the region indicated, and the crop has been found to attain its greatest perfection in the north and the north-eastern divisions of that district; the portions that may be said to face eastwards toward the Brahmaputra valley. In Bogra the crop can alone be said to be important in the northern and north-eastern portions, and, generally speaking, the southern districts are unfavourable for ramie cultivation. Clay, rice, and jute lands are not suitable for the growth of the fibre.

In Bengal ramie, or rhea, is propagated by root cuttings, though the system of burying horizontally stem cuttings is sometimes pursued, more especially to fill up vacancies, and to increase the number of plants in the fields. The cuttings are usually from six to nine inches in length, and are planted under three to four inches of soil. They are placed from one to three feet apart each way. There are two seasons for transplanting—the first in April to May (before the commencement of the rains), and the second in September to October (at the close of the rains). The

majority of cultivators choose the former season, as there is less chance of failure in germination.

The fields have to be weeded and hoed after each cutting, and must be heavily manured every year during the cold season. Unless they are very heavily manured the plants should be transplanted into new plots of land after two, three, or four years, according to the fertility of the soil. The refuse from decortication is the very best manure, and it should be returned to the soil; if this is done theoretically there is no withdrawal of plant food from the soil, and the only manuring required would be this return of the refuse to the land. In practice, however, a certain amount of wastage will occur. This must be made good by the addition of a limited amount of manure to the refuse. Once an enterprise has been established, and the first quantities of refuse have thoroughly rotted, the supply of manure will not be a very expensive item. In laying out a plantation for the first time apply organic manure, as it gives the young crop a good spring, and enables it to establish itself quickly.

The shoots must be cut down where the bottom portion of the stem begins to turn a brownish yellow colour. At this stage the leaves low down on the stem also begin to fall off. Two to four, or even five, cuttings are obtained each year, the shoots being from four to five feet in height. The majority of cultivators say three cuttings is a good average crop. Two cuttings they regard as indicative of neglectful cultivation, and five or six can be obtained from plots which are shaded, heavily manured, and freely watered. As a rule, the entire crop is cut down at one and the same time, but the more intelligent cultivators select the stems as they ripen, and thus only cut small quantities at a time, as they mature throughout the year. This should, in the author's opinion, most decidedly be the practice on all lands on which ramie is cultivated. The mature stalks only should be cut, and the immature stalks allowed to grow. The result of this method will be found to be that only first-class fibre will be gathered, instead of probably twenty different classes of

fibre in one bundle. For this the cultivator will receive a much better price, and the spinner will appreciate the inherent merits of the textile to a far greater degree. On account of its uniformity he will be able to treat and manufacture it with greater ease, more economically, and in his turn will secure higher prices for the yarns, which will be more suitable for manufacturing into superior descriptions of materials.

From September transplanted plots in Bengal the following are given as the best cutting seasons :—

First cutting in May (the worst cutting).

Second cutting in June (the best cutting).

Third cutting in July.

Fourth cutting in August.

If transplanting takes place in April-May there are, as a rule, only the three cuttings, those already indicated, and a cutting made later than August is regarded as yielding a very inferior fibre.

So far as regards the all-important point of outturn and cost of production, it has been recommended that the Government or persons anxious to ascertain this definitely should, without warning, purchase (preferably in the Kurigaon sub-division of Rungpur) the crop as found in two or three plots in various villages at each of the seasons, reap the stems at once and separate these by machinery or otherwise; and if careful returns are preserved of the size of the plots, and of the actual number of plants, as well as the weight of green stems and the weight of clean, dry fibre, or of the ribbons, an accurate opinion as to the yield per acre would be arrived at.

New plantations get on well for three or four years, so far as the caterpillar pest, which at times gives trouble, is concerned. This caterpillar is called by the cultivators of Bengal "malpoka." When it is noticed the roots of the fields must be transplanted. Well-cared-for plantations, native cultivators state, will last for several years—in fact, says one of the best cultivators, for ever.

It is the rule to wait for the appearance of fine weather before cutting the crop. The stems require to go through

a process of drying, and rainy weather, or even cloudy days, during the drying stage are said to injure the fibre. The shoots are then removed to the homesteads of the growers, and by means of a bamboo knife, or scraper, the natives deprive them of the bark and the green succulent outer tissue around the fibre, and it is regarded as necessary that all the plants should be scraped, or decorticated, within twenty-four hours of being cut. The stalks are then laid out on the ground in some dry situation exposed to the sun during day, and removed within doors at night to avoid the dews, and this method of drying is continued for some four to ten days. The stems are thus completely dried, and the adhering fibre more or less bleached. The stems are then broken across a little below the middle by the natives. The finger, or scraper, is inserted underneath, and is run upwards and downwards until the whole of the fibre is removed. For this purpose the central stem may have to be broken more than once.

This stage is considered the most troublesome of all ; it is the one which, as before stated, the native dislikes, and hence the need of an effective machine for taking the place of hand labour. After being removed from the stem, the fibre is once or twice drawn rapidly between the scraper and the flat surface of the fore-finger in order to free it from any adhering particles of the stem and bark. The after-cleaning of the fibre preparatory to its being spun into thread is done for the most part by the women and children, being considered work suitable for them, and consists entirely in cleaning and splitting up the fibre by means of the fingers.

It is stated that in Bogra the partially cleaned fibre is boiled for a very short time in the water obtained from cooking rice, which is said to soften it. The Bengal cultivator, it may here be observed, always scrapes off the bark before separating the fibre from the stem, and thus offers for sale what may be termed a crudely cleaned fibre (China grass). He never strips off the ribbons with their adhering bark from the stems of

the plant, and subsequently cleans, or dries, and then sells them. Sir George Watt says on this point that he considers the supply of the much-condemned Indian rhea, or ramie, ribbons (the peel stripped from the stems) that have given a bad name to, and greatly, though unjustly, lowered the value of, this fine Indian fibre, are invariably derived from European experimental cultivation, or have been prepared to order by request of European spinners who are not versed in the trade, nor the difficulties which they will experience in treating and manufacturing the product. It is true that if they are carefully dried, kept clean, and baled in such a manner that fermentation will not set in on their transport by sea to manufacturing centres, the owners of a really effective and economical process for degumming ramie may without difficulty extract the fibres in a satisfactory manner, and without damaging the strength of the product, but up to the present time it is almost always found to be the case that ribbons are baled in a more or less damp condition, and that they are largely charged with dirt; the strength of the fibre is accordingly more or less impaired by a certain amount of fermentation which sets up in transport home. This is the result of careless European supervision, the natives often being left to dry and bale the ribbons themselves, or but little supervised in the operation, and the direct outcome is that even when they are submitted to the action of the most perfect systems of degumming for removing the epidermis, or outer covering, and eliminating the gums and resins in which the fibres lie embedded, and prepared and spun into yarn upon the most approved and perfect machinery, the yarns are found, when woven into piece goods, to deteriorate in strength when submitted to the bleaching process, and those who have purchased the goods for home consumption, or export, are disappointed and put to loss by claims being later made upon them by customers who have bought the goods and found that in a little time they went weak in strength. In these circumstances more than in any others lies the explanation

of the reason which has puzzled so very many, why ramie, by reason of its known intrinsic merits, has not long before this established for itself a foremost place amongst vegetable textile fibres on the world's markets. Further, it may be observed that, exported for manufacture in the form of the bark strips, or ribbons as they are generally called, containing almost the whole of the gums and resins which impregnate the fibres, these harden and solidify on the voyage, necessitating stronger and more expensive chemical treatment to effect their extraction, with the attendant danger of damaging the strength of the fibre, and as they only yield from 45% to 55% of their nett weight of useful fibre, freightage is paid by the spinner and manufacturer on from 50% to 55% of bark and worthless matter, to say nothing of insurance charges, which are, nevertheless, a consideration. Each stem of ramie, it may be remarked, is surrounded by a skin or pellicle, which, if allowed to dry upon it, assumes a brown colour and clings to the fibre with remarkable tenacity, and to remove it successfully has proved the despair of many able chemists. In doing so they too frequently have attacked the strength of the fibre, destroyed its lustre, made it harsh and brittle, affected its nature for taking dyes, and matted it, causing thereby great loss in combing operations.

The Bengal cultivator, speaking strictly, first decorticates, and then strips the fibre, which is a more rational process than that followed by many inventors of so-called decorticating machines, which either merely strip off the bark with its adherent fibre, or smash up the contained stem, and so set free the bark and fibre in this manner. It is probable that this after-process of drying the exposed fibre before separating it from the stem is advantageous, for those who are conversant with the ways of the Indian cultivator are agreed that he very seldom does much within his own sphere of life that is useless, and he certainly never imposes on himself any considerable additional labour which is to no purpose.

With reference to ramie culture in Assam, speaking of the early history of the plant Dalton says the Mishmis

were probably the first people on this side of the Himalayas to discover the valuable properties of the ramie, or rhea nivea, and many others of the nettle tribe, and with the fibre of ramie they wove a cloth so strong and stiff that made into jackets it was used by them, and by the Arbors, as a sort of armour. These may have been made from the "bon" (wild) rhea; at any rate this fibre is woven at the present day into garments by most of the hill tribes of Assam.

According to Hannay, the fishermen of Assam cultivate rhea, and as the fourth crop is that which bears seed they cut it down before the seed is formed, and propagate the plant entirely by dividing the roots, using ashes as manure and cow-dung as a winter covering.

The area under ramie culture in Assam is about 2,000 or 2,500 acres, and it would undoubtedly be much more extensively cultivated but for the fact that the Assamese use it only for making fishing lines and nets, and are unacquainted with the higher uses to which it can be put. Ramie can be grown in Assam on a variety of different soils; the best one is light and free, not stiff. In the Assam Valley the rich loam which composes good tea land has been found suitable for it, and in Sylhet it is grown most successfully on well-drained bhil land. It is, however, mostly raised on sandy loam which has been artificially fertilised, chiefly with cow-dung manure. In addition to cow dung they manure with dry grass, and rice husk mixed with earth obtained from other fields; the husk is also very often given in the condition of ashes. The plant grows very well where castor oil trees abound, and the natives state the castor oil leaves greatly enrich the soil, so that the two plants flourish in association. Planting is done from 15th April to 15th May, and 15th October to 15th November. Transplanting takes place in January, by which means the first cutting can be made in May, and this allows of five good cuttings in the year.

Mr. Monahan, Director of Land Records and Agriculture, Assam, lately gave some details of great importance in favour of Assam, which accounts for the plant fur-

nishing a crop of shoots late into the cold season. He says that at Saharanpur, and in all other parts of Northern India, except Assam, little rain occurs during the months of cold weather (November to March), and the early part of the hot season comprised in the months of April and May, and the first half of June, is characterised by intense heat, which is dry. In Assam there are no dry hot months, the rains setting in regularly by the middle of April, and even during the cold weather humidity is greater than in other parts of Northern India. Accordingly in Assam ramie continues growing throughout the year, though at a somewhat slower rate in the cold weather than in the rains; and whereas at Saharanpur the crop is cut only twice a year—once in June and once in October or November,—in Assam cuttings are obtained at much more frequent intervals. According to the statements of numerous cultivators who have been examined, there is no difference as regards the quality of their fibre, or the difficulty of separating it, between ramie stems cut in the cold weather and those obtained in the rains. At the end of March, after unusually dry cold weather, in Lower Assam stems over six feet high, and apparently uniform, of rhea plants which had only been cut two months before have been seen by Mr. Monahan. The rapidity of growth, however, especially during the cold weather, depends much on the amount of manure applied and the general care taken in cultivation. The stems just referred to were grown on carefully tended land, while at the same time, and on land of probably the same natural fertility, the rhea crop observed was stunted, and not likely to yield any fibre until the beginning of the rains, as a result of careless culture.

The outturn of clean fibre in Assam is estimated at 640lb. per acre. Experiments made in Nowgong in 1885 gave an estimate of 911lb. per acre, however. One very intelligent cultivator states that for many years a plot of land 15yds. by 30yds. has yielded him one maund of clean fibre a year, or at the rate of 10.75 maunds an acre. If the ramie stems after being cut and wiped get wet or dirty, the fibre is said to rot.

The Assamese peasant, Mr. Monahan says, is strongly averse to giving any information about the outturn of his crops, and any statements which he makes on the subject are, as a rule, underestimates.

An actual crop experiment was made by Mr. L. J. Kershaw, Assistant Deputy Commissioner, Golaghat. The area of the plot selected was 430 square feet, which is the ordinary size of a plot of ramie grown by the ryots in the district, from which it appears that the total weight of the crop of an acre, stalks and leaves, first cutting, would be 11,185lb., made up as follows: Leaves, 6,320lb.; bark, 1,090lb.; moisture, 3000lb.; cleaned fibre, 118 $\frac{3}{4}$ lb.; dirt, acid, bark lost in washing the uncleaned fibre, 18 $\frac{1}{2}$ lb.; sticks, 637lb. This was about three times as great as was obtained in the Nowgong experiment, and would mean over 900lb. per acre when the plant was thoroughly established. Waste land suitable for ramie crops is available in abundance in Assam. So far as the labour question is concerned it may be said that the present condition of the Assamese peasant is such that he is not compelled to engage in any laborious occupation in order to obtain a subsistence, which is all that he requires, and even the trouble of preparing jute for the market, which fibre, like ramie, can be very successfully grown in Assam, has been sufficient hitherto to deter him from the cultivation of that crop, in spite of the large profits which it would yield him. So it appears that ramie cultivation, if it is to be introduced on a large scale in Assam, must be established, like tea growing, by European or American capital, with the help, to a great extent, of imported labour.

The plant takes two years to establish itself thoroughly, and some advise that the bushes should be cut down during the first two years of growth when they reach a height of three or four feet, as this induces the roots to spread with greater rapidity.

In the Shan Provinces of Pivela and Youkzouk, six or eight days' journey to the south-east of Ava, ramie has been found. The Shans use this fibre in manufacturing every kind of cordage, and in weaving a

stout kind of cloth of which they make bags. They call it "pan," and the Burmese call it "goun." At Nanlan, Burma, small plots of the plant may be found attached to several houses in all the villages on this plateau, but it is only cultivated for domestic use, and not for sale as a general rule, though small samples of it are sometimes procurable in the Nanlan Bazaar, where it fetches as much as 8 annas a viss, which equals 3.68lb. av. It is stated not to require much care in culture there. The thugyi says that if there were any sale for it the people would be glad to extend its cultivation. Nanlan is only thirty miles away from Thibaw, and will be within twenty miles of the branch railway to Kyatsi Mansam, so that it should be worth while to encourage the Shan people to extend its cultivation. The plant was introduced into Burma from China. Linschoten says, describing the "Herbe Bengalen," which he states was used for sewing quilts: "They do most cunningly stitch their coverlets, pavilions, pillows, carpets, and mantles. Likewise they make whole pieces, or webs, of this herbe sometimes mixed and woven with silk, although those of the herbe itself are dearer and more esteemed, and is much fayrer than the silk. These webs are named sarrijn, and are much used and worn in India as well for men's breeches as doublets, and it may be washed like linen, and being washed it sheweth and continueth as faire as if it were new." His remarks seem to apply more to ramie, or rhea, than any other fibre. Whatever the fibre was it is not now employed in that way, so it is possible it was ramie, and that a more extensive knowledge of the fibre, and a wider cultivation, prevailed formerly than at the present time.

The Glenrock Rhea Growing Company obtained the results following, growing the fibre on their property at Pandalur, in South-East Wynaad, which are of considerable interest as bearing on the Mysore district and future experiments, and also undertook the cultivation of rhea at Kullar, in the Bhowany Valley, about five miles from Mellapollium. Some 400 acres of rhea, or ramie, were planted in the forests on the slopes of

the ghats below Pandalur village, and about 100 acres at Kullar.

The growth of the stems was all that could be desired, as many as six cuttings of stems being obtained in the year where assistance could be given to the plant by irrigation. Without irrigation, at Pandalur, three cuttings were obtained between the months of June and November, during which months the rainfall was about 100 inches in all. The best outturn from one measured acre in 1886-7, under irrigation during the dry months, was six cuttings:—

1,384lb. of stems (8 stems to the lb.)	about 11,000 stems
2,028lb. " (8 " ")	" 16,000 "
4,446lb. " (5 " ")	" 22,000 "
4,904lb. " (6½ " ")	" 30,000 "
3,660lb. " (9½ " ")	" 25,000 "
1,605lb. " (15 " ")	" 24,000 "

18,027lb. { (8 tons) weight of year's stems about } 128,000 stems

Great difficulty was experienced in drying the ribbons during the rains in the Wynaad, where alone the stems grow except under irrigation. Drying-rooms were made with hot-air pipes and exhaust-pans for drawing off the moisture. These experiments in cultivation were carried on by the Glenrock Company from the commencement of 1884 until 1889, say five years, but the prices paid by ramie spinners for the fibre then did not show a profit on the cost of production, and the plantation was given up. No doubt this was due to the fact that the methods for preparing and spinning the fibre in those days were not nearly so economical as at the present time, much waste being made, and so prices ruling for ramie yarns did not permit of higher prices being paid for the product; also because the yield of dried ribbons obtained by Death and Ellwood's Decorticator, which was used, was only 3½ per cent., giving 1¼ per cent. of fibre, and not so much from any defect in the cultivation of the plant. The latter Mr. Bernard Coventry, of the Agricultural Research

Institute, Pusa, appears to think was satisfactory. The rhea planted by the Company, though deserted, was, several years afterwards, found contending with the jungle growth. The manager of this Company, in answer to an official inquiry, said: "I think the soil and climate of the Wynaad were very suitable to the cultivation of ramie. There is always very little rain for four or five months of the year; possibly a more equable distribution of the rain would give a fourth cutting." This latter fact is so.

Some writers make their calculations as to yield on the produce of a square metre of land; others on the produce of a square yard of land; still others on the number of stems cut. The outturn of bark ribbon from weight or number of stems treated depends on the condition of the stems, how long they have been cut, their age, and condition when cut. Mr. Minchin says, in regard to ramie culture: "Stems will not all grow to the same size; they must be cut when they begin to brown at the base, whatever their size." In Algiers ten per cent. of ribbons, or bark strips, has been obtained from green ramie stems. The climate there is dryer than in Wynaad, and there is probably a much smaller proportion of water in the green stems. Dr. Forbes Watson, who was some years ago Adviser on Economic Products to the Government of India, calculated that the proportion of water in the green stems varies from 75 to 80 per cent. In 1872 7,360lb. of stems were cut from $1\frac{1}{2}$ acre of ground in the Saharanpur Gardens, and Colonel Hyde assumes the crop to be two tons of stems per cutting per acre. Mr. Montgomery calculated the outturn of ribbons to the weight of green stems at $6\frac{1}{4}$ per cent. from large stems and $3\frac{1}{4}$ per cent. from small stems, and as he had marked success in cultivating ramie in the Kangra Valley for some twelve years, considerable weight must be attached to his remarks on the subject.

On another estate at Reading, in South India, which was under cultivation from 1887 until about the middle of 1894, the highest yield from one cutting of an acre was 64cwt. 3qrs. of green stems. The average yield

came to 1,200lb. of green ribbons per acre per crop, on what was called the bed system of cultivation. On the open system an acre yielded: Second crop, 2,056lb.; and third crop, 2,685lb. green ribbons. It was found that the dry ribbons ran to about 20 per cent. of the weight of green ribbons, and dry ribbons ran to about 7 per cent. on the weight of green stems. Irrigation and manuring were found necessary. In culture some little time ago in the Madras Presidency one planter got as much as 18,027lb. of stems, or canes, without leaves, off an acre of land in the second year of culture, which at a 10 per cent. yield would give 1,800lb. of dry ribbons, or 900lb. of filasse fit for combing. There are not many planters, however, growing ramie in South India at the present time, as it cannot be cultivated at a price that will pay.

Speaking generally of ramie culture, if 10,000 cuttings are procured for purposes of propagation, one may, after six months (it is not well to do so before), obtain a supply of root and stem cuttings, say twenty from each original stool, which will bring the number of cuttings up to 200,000, capable of planting sixteen acres. Six months later four million cuttings may be obtained, capable of stocking, under favourable circumstances, 315 acres. It would take fully eighteen months, however, before 500 acres could be supplied. During that time few, if any, stems will be available for crop, as they will have been cut up for the purposes of propagation. The best cuttings are obtained from the matured wood, but treated under glass in fine sand the tender, or herbaceous, portions of the stems will also take root. The best plan when propagating by the division of the tubers of ramie offsets and stems is to lift a matured plant bodily for the purpose of division. In Mysore, the hill country in the districts of Hassan, Kadur, and Shimoga affords the position and climate best suited for the hardy growth of rhea, or ramie, and in the most favourable situations it is not impossible that the plant would run wild to some extent.

There has been no experiment in North Bengal or Assam that can for a moment be compared with those

made by the Glenrock Company and at Reading, and all in authority are agreed that there would seem to be little doubt that better yields are to be obtained in these provinces than in Madras and Mysore, and Colonel Hannay, who devoted some considerable time and study to the problem, formed the ultimate conclusion that a yield of about 12 maunds of clean fibre to the acre can be obtained in Upper Assam.

Reference to Indian ramie cultivation would not be complete without giving details of what was accomplished by Mr. Montgomery at Ram Bagh, in the Kangra Valley, from which much that is in favour of successful Indian culture of this fibre can be deduced. This estate was established in 1862-3. The firm with which Mr. Montgomery was connected ceased business shortly after his arrival in India, in 1863, and he was left single handed. He, however, determined to proceed, and obtaining a supply of seed and a few plants from China, he from these stocked his plantations, from which large supplies were afterwards sent to the Saharanpur Botanic Gardens, to Assam, to the Glenrock Company in the Wynaad, to Baroda, to the Deccan, and to the Sultan of Johore. His Excellency Lord Mayo paid a visit to Ram Bagh three months before his death purposely to study the cultivation of the plant, and witness the extraction of the fibre from the stems. Chinese workmen were at the time employed at the Government Holta Tea Estate at Kangra. Mr. Montgomery secured the services of some of those men. They recognised the China grass or "Tchow-ma" plant immediately on their arrival at Ram Bagh, and expressed their surprise at seeing it under cultivation. They stripped the shoots of their leaves, and, laying the canes flat on a board, scraped off the green bark, clean water being made to play along the board as they were doing so. From these Chinamen Mr. Montgomery ultimately learned many details in regard to cultivation and the process of cleaning the fibre, which contributed much to the success he met with later on. The Ram Bagh is a bit of fertile rich loam situate down in the very bottom of the valley, and only a foot or two above the level

of the river, but the various ramie plots were well shaded by avenues of fruit and other trees. Irrigation and even silt manure were available whenever required.

In a report which he made after several years' experience in the cultivation of ramie and its preparation for export, he says :—Ramie must be propagated by seed in some instances when the germ of the plant has to be carried over long distances, but probably great disappointment will attend the result. To get good seed care and a favourable atmospheric season are necessary. For seeding purposes young shoots should be carefully reserved in a well-sheltered position. These plants should receive special care and be well manured. During the rainy season they must be kept carefully drained, and after that time has passed the ground should be carefully loosened round the plants. If the rains cease early in October a fair amount of seed may be obtained, but so far as I can judge no amount of care can ensure complete success, so much depending on the season, a dry one being most favourable for the full development of the seed. The only method of sowing which I found successful was on a gentle hot bed under glass in March and April, the seed scattered over the surface, covered very carefully with sifted earth, and well shaded from the sun until the plants were about three inches high, when sunlight may be carefully admitted. When sufficiently strong they should be planted out.

In propagating by cutting of the stems, the stems should not be cut until duly ripe; then the stem must be divided into short lengths. When planted, if the weather be damp and cloudy, they will readily strike root; otherwise they will require shading for a week or ten days, the soil being kept moist. Propagation by division of roots is, however, by far the most advantageous and profitable method. The plants for this purpose should be three or four years old. After gathering the crop dig up each plant carefully and remove the earth from the roots. Put the mass of roots into running water for a short time; this cleanses them thoroughly, and enables the gardener to see his work clearly. Separate

the roots carefully, rejecting all fibrous and decayed matter. Expose these sets to the sun for a couple of hours to dry them, and then plant four to six inches deep, and at a distance of four feet apart every way. In this manner two good crops will be obtained from them the first year.

A rich loam suits the plants best, but they will grow in any kind of soil, provided a full supply of moisture be available, combined with thorough drainage. The latter is urgently required, particularly during the rainy season, as, should the land be retentive and become swampy, the plants will wholly decay in a very short period. If the land be poor a liberal supply of manure is requisite, otherwise the stems will be short and weak, yielding scarcely any fibre. Inferior lands should, however, not be selected for culture if possible. In weak lands close planting should always be adopted. In no part of Upper India can the plant be successfully cultivated unless water for irrigation be available during the dry season. If the facilities for obtaining an ample supply of water are good, with the moderate temperature at all seasons, this district is particularly favourable to the plant, though transport rates are high.

Should the land have been stocked with seedlings or cuttings, then in the following spring, after having reaped the first crop of available shoots, every other plant should be transferred to fresh ground. The following year the same course should be pursued, each alternate root being taken up and replanted. After this the plants may well remain undisturbed for four years, hoeing well between after each crop, clearing away weeds (it is absolutely essential wherever ramie is grown that the ground should be kept clear of these, as, springing up, they choke its growth), irrigating moderately during the dry season, and supplying manure where necessary. The only manure I had at command consisted mainly of the leaves and woody portion of the plant itself, and of tree and vegetable leaves stored up for the purpose, with which I found it well to mix a considerable amount of wood ashes. I recommend a thorough removal of the plants after four years, the

land being then well ploughed, cleaned, and manured.

The periods for reaping will vary slightly, according to difference of season. I find that in this district three good crops can be relied upon each year. The first during the latter half of April, the second about the commencement of August, and the third about the end of November. It will be found of much advantage to postpone reaping the second, and particularly the third, as long as the condition of the plants will admit. If the third crop be cut in the middle of November, the weather here during the remainder of that month is not sufficiently cold to keep back the new growth; and should the young shoots appear above ground early in January, the frosts which are usual at that period seriously injure them and lessen the spring crop. My experience indicates that the stems should be gathered as soon as the cuticle shows a clear brown colour for about one-third of the length. At this stage, if the soil be good and the plant healthy, the stems will be clean from bulb to point, and the leaves of a rich dark colour above and pearly white below. If gathered earlier than this, I find the connection of the fibres very weak, and that a considerable portion separates in the operation of scraping the peel.

The average height of the stems which I have grown has been six feet, after cutting off the soft portion at the top. In gathering, I supply each coolie with a sharp pruning knife. With this they cut the ripe stems close to the bulb, and these must be removed by boys to the nearest manure pit. Here the boys cut off nine inches of the top, and pass one hand with a gentle pressure from top to bulb; this removes every leaf. The stems are then placed in clean water, from whence the peelers remove them and separate the peel, which is again thrown into water, from which it is withdrawn as wanted by the men who clean it. The men lay three or four strips of peel on a flat board, scrape it a few times on the inner side from bulb to point, then turn it over and repeat the scraping, which removes the cuticle; it is then hung up or thrown on clean grass to dry.

Taking the distance of four feet apart for fully bearing plants, an acre will contain (allowing for paths and water channels) 3,000 plants; more than this I find to be too crowded and to increase labour, while lessening the actual yield during a four years' period. Thus planted the yield will be a steadily increasing one, and the plants will not show any deterioration.

From repeated experiments with weighings, I have deduced the following average proceeds from 1,000 freshly cut six feet stems :—

Weight as cut	286lb.	
Do., when dried	77.5 = 27	per cent.
Do., fresh peel	83 = 29	„
Do., dry peel	21.5 = 7.5	„
Do., fresh wood	203 = 71	„
Do., dry wood	56 = 19.5	„
Do., clean dry fibre . . .	18.7 = 6.5	„
Do., water	208.5 = 73	„

If larger stems, from seven to eight feet, be taken, the average is less in the weight of peel, but in the outturn of clean fibre it is slightly greater. With small stems, from three to four feet, the percentage of peel is markedly greater, but the return of fibre is barely 35 per cent. Moreover, the extra labour in cutting, peeling, and cleaning these small stems is an important consideration. The crop cut during the rainy season will always contain a larger percentage of water, and that of clean fibre will be found rather less, the fibre being also softer than at the other periods of cutting. This I consider due to this fact: that at this period the resinous matter in the plant is in a more diluted state, and consequently a greater portion of it is removed during the process of washing and scraping the peel. The crop should be sorted as cut, according to the length of the stem. If the plant is cultivated as I suggest, the difference in length of the stems at each cutting will be found very small, the monsoon crop always giving the longest stems.

In regard to acreage yield, taking the foregoing as a basis for calculation, and knowing that each plant, if

established as I recommend, will give at least an average of six stems during the first year, I assume :

$$\frac{\text{Plants} \times \text{Stems} \times \text{Crops} \times \text{Lb.}}{1,000} = \frac{3,000 \times 6 \times 3 \times 18}{1,000} = 972 \text{lb. per acre per annum,}$$

and my experience has shown me that with proper open cultivation 1,000lb. clean fibre per acre may be fairly assumed.

It will here be of very considerable interest to give the estimate of cost of production arrived at by Mr. Montgomery, and in doing so it must be borne in mind, in drawing conclusions from the same, that his experience in the practical cultivation of the plant upon a commercial scale extended over a longer period of years than either that of Mr. Minchin, in South-East Wynaad, or Mr. W. Rhodes James, at Reading, or any other European who has cultivated the plant in British India. He says in his report : I would now allude to the cost of growing and separating the fibre into a state fit for export. After a careful review of my actual outlay I estimate this as under :—

	Rs.	a.	p.
Land rent per acre per annum.....	10	0	0
Cultivation, $\frac{1}{4}$ man per acre at Rs.5 per mensem	15	0	0
Cutting and training stems, two men for three months at Rs.4 per mensem each	24	0	0
Peeling and scraping, seven men at Rs.5. per mensem each.....	105	0	0
Native supervision, at Rs.10 per mensem for 50 acres, say.....	2	8	0
	<hr/>		
Cost of 950lb. of fibre.....	156	8	0
	<hr/>		
Or total (per ton).....	Rs.369	0	0

This statement as to cost of cultivating, as the result of Mr. Montgomery's twelve years' experience, works out at £3 9s. per acre, taking the value of the rupee at one shilling and fourpence, and excluding from the cost of growing the item of Rs.105 for peeling and

scraping, wages of seven men at Rs.5 per mensem each, in place of which must now be substituted cost of "Faure" machine decortication, £1 12s. 6d. for 950lb. cleaned fibre, which means total cost of cultivating £5 rs. 6d. per acre. The item of Rs.10 per acre for land rent per annum agrees with figures quoted to the author for rent in different ramie-growing areas in the East and elsewhere, and also with the price quoted in the same manner for the purchase outright of land for the culture of the fibre. Mr. B. Coventry, it may be observed, estimates the cost of producing one ton of ramie fibre per annum from three acres in India to-day at Rs.313, which, he states will show the planter, if he obtains £30 per ton for his decorticated fibre, a profit of Rs.45, or £3, per acre.

It will be noticed that Mr. Montgomery evidently found native supervision of the plantation to answer satisfactorily.

In regard to Mr. Montgomery's estimate of yield per acre, Sir George Watt remarks: "I believe the estimate is very likely to be correct, and in Assam is probably exceeded." He, on the 12th November, 1894, paid a visit to the Ram Bagh plantation in Kangra, in order to inspect what remained of Mr. Montgomery's farm, and from his widow, a lady then over eighty years of age, received many interesting details of what had been accomplished there. She had, since her husband's death, zealously continued to supervise the property, and on the question of transplanting and exhaustion of the soil she said that formerly every now and then the plants were dug up, the old wood rejected, and fresh shoots replanted in the same ground. Manuring she could not go to the expense of, but in her opinion the soil was so fertile that there was no occasion for it. One field had not been taken up for sixteen years, and yet the shoots on it were fully five feet in height when Sir George Watt inspected it in November, 1894. Thus, he says, for over thirty years the China grass plant has been grown on the Ram Bagh plantation without showing either degeneration of stock or exhaustion of soil. He adds: "Mr. Montgomery was hampered by

lack of funds, and did not possess machinery and appliances to reduce the cost of cleaning the fibre, and the price which was paid for the hand-cleaned filasse, which he produced during the fairly long period of years in which he cultivated the plant, was not very remunerative. The success which attended his growing efforts points to a ramie-cultivating industry being possible in that district, and, perhaps, in some parts of Gurdaspur as well. Much suitable land might be had at reasonable rates, labour could be easily and cheaply procured, and possibly river or canal irrigation easily available. The sites chosen, however, for ramie culture should not be remote from the tea localities. Ramie is not cultivated by the natives in the district; still, it must be admitted that a small farm like Mr. Montgomery's, that can continue to yield stems eight and twelve feet in height after a continuous production of over thirty years, cannot be said to prove the futility of further efforts."

On the basis of analysis made of the ramie plant by Dr. Forbes Watson, Adviser on Economic Products to the Government of India, some years ago, it takes the following constituents from the soil each year: 1,938lb. potash, 978lb. soda, 576lb. phosphoric acid—that is if a crop of 16 tons of stems per acre per annum, or 3 tons or 6,000lb. of dried stems per acre each year, be obtained from the land.

In relation to ramie culture in the North-West Provinces and Oudh, it is not produced by the natives in these provinces, but it has been, and is to-day, grown in the Saharanpur Botanic Gardens, and in Dehra Dun. This was undertaken originally to supply the material for the two sets of fibre-extraction experiments that were held at the Government Gardens in connection with the bonus offer for fibre-extracting machinery made in 1869. Mr. Gollan, superintendent of the Saharanpur Gardens, says on the subject: Three good crops can be obtained in the course of the year, but, taking Saharanpur as a centre for calculation, freight alone upon an impressed ton of rhea bales amounts to Rs.75 4a., or at 1s. 2d. per rupee equals £4 7s. 9½d.

In the comparatively dry climate of Upper India the cost of cultivation is very high, as the absence of atmospheric humidity and equable tropical warmth at certain seasons of the year, has to be compensated for in order to secure what, at the best, is only a light crop, by choosing the richest of soils, further enriched with expensive dressings of fertilising manures and frequent stirrings of the soil between the plants. Saharanpur is certainly not a good spot for ramie cultivation, but it is typical of large stretches of country in Upper India. I will here admit that there are a few favoured spots in Upper India where rhea thrives better and may cost a little less for cultivation than it does here, Dehra Dun, and the Kangra Valley for instance, and if a fair price is offered by spinners for the fibre it would be worth while for planters at Dehra Dun and in the Kangra Valley to try experiments with ramie cultivation. These two districts are tea-growing districts, and I look upon tea cultivation as a good objective to hold in view when looking for likely spots for the perhaps eventual profitable cultivation of ramie. Where tea thrives I believe rhea, or ramie, will thrive, and also that it will cost less for cultivation than in districts of which Saharanpur may be taken as a type; moreover, where tea gives the best results rhea, or ramie, will, I have no doubt, be found to give the best results. Dehra Dun and the Kangra Valley are not to be compared with some parts of Assam and Ceylon as paying tea-producing districts, and I am firmly of opinion neither will they compare with the latter districts as paying rhea, or ramie, producing centres. The most reliable experts are agreed that there is nothing to show that ramie can be grown commercially anywhere in the vast plains of the North-West Provinces and Oudh, nor in the Central Provinces of India, nor in Bombay. Sir George Watt's opinion is that here and there within each of the provinces there are, of course, sub-montane tracts where some degree of success might be obtained, but experience in South India can hardly be said to justify even these being at

present selected for experimental cultivation upon a large scale.

Mr. Samuel Jennings, F.L.S., has given some valuable particulars which show the rapidity with which this plant can be propagated. From the small supply of plants from which Mr. Minchin stocked the Glenrock plantation, 2,500 plants were obtained to start with. In the following November, 200,000 plants had been obtained from the original stock by cuttings, layers, and root divisions. These were again taken up and divided, and in June, 1886, the number of plants had been increased to about two millions. A remarkable example of arithmetical progression applied to agriculture deserves to be recorded. From one root planted in January seven stems were each divided into five cuttings, and most began to grow in a week. From this one plant 57 strong root cuttings were taken, making in all 83 plants from one root not five months in the ground, and that under rather unfavourable conditions, the soil not being good and no water or shade. Again, a single root left undisturbed for a year had so increased in size that 42 stems were counted in various stages of growth. The plants require to be left a whole year before they are cut for fibre. During the second year only half a crop should be expected, the yield of the third year will be greater, and from the fourth year full crops will be cut. This is Algerian experience; it has to be seen if the rule holds good in Indian cultivation.

In Algeria they reckon the average weight of each stem of ramie when ready to be cut to be $1\frac{1}{2}$ oz. At Glenrock the weight of the stems when mature was found to be 3oz. There is no doubt that the growth of ramie is more robust in India than in Algiers. In Algiers calculations are based on the results obtained from *Boehmeria tenacissima*, while Mr. Minchin's refer to *Boehmeria nivea*. He grew both specimens at Glenrock, the latter being found far more robust in habit and quicker in growth. During the wet season the stems will certainly contain a far greater waste of moisture than at other times, and this is the case with

Boehmeria nivea, with stems 7 to 8 feet long, and weighing over six ounces each. It does not, however, follow that the actual weight of fibre will be less; neither can it be said that the same results would follow in different parts of India under different conditions of soil, temperature, rainfall, etc. In propagating by cuttings and root divisions, in one month new shoots appear, in three months the shoots will be four feet high, and in six months there will be five or six strong stems. Separations of the tubers are much slower in growth than cuttings, and in hot dry weather the best mode of propagation is by layering without complete separation.

Mr. Minchin sowed 2lb. weight of seed on the 27th March, occupying an area of 1,400 square feet; germination took place on the 3rd April. Much trouble was at first experienced with ants, but it was found that a little kerosine oil mixed with the water successfully kept off these depredators. In four months the seedlings were 18 inches high, and strongly rooted. Both cuttings and seedlings require partial shade till they are well established.

The French ramie growers in Algeria recommend their own system of planting out at 18 inches apart, so that each acre will contain 16,000 plants. This no doubt applies to *Boehmeria tenacissima*, and in a climate less forcing than that of India.

At Glenrock Mr. Minchin put in his plants in six-foot beds, separated by a one-foot drain, two rows in each bed, three feet apart, and eighteen inches between the plants in the row, so that in Glenrock 7,000 plants occupied an acre. He found that the space between the plants quickly fills up with new growth, and the ground soon becomes quite covered. Irrigation is a matter of considerable importance, as it will probably make a difference of one crop in the year.

A portion of the Glenrock planting was left without any artificial watering in order to observe the result. It was found that, although the root growth was not materially checked, there was scarcely any movement above ground between the months of February and

May. On the irrigated fields the dry heat did not seem to affect the development of the shoots in the least; in eleven days stems were observed to have grown fifteen inches. The growth of ramie is more vigorous on the hollows than on ridges, or on level ground. At Glenrock the altitude above the sea is about 2,000 feet, and the rainfall is exceedingly heavy during the monsoon. Ramie has also been grown in the Bhonani Valley, at the foot of the Neilgherrie Hills, in the Coimbatore district. Here, where the soil is rich and the climate very forcing, the development of the plant appears to be much more rapid, and the growth more uniform and vigorous than at the greater altitude of the Wynaad. Fairly close planting is strongly advocated in order to induce tall, straight growth and check the formation of side branches. It is also stated to be a great protection from the ravages of caterpillars and other insect pests, which devour the leaves, and so cause side growth.

As regards shading ramie in cultivation, the practice varies considerably in different countries. In the Indian Archipelago ramie is planted under the shade of forest trees. In Algeria and in Egypt it is grown in the open field, entirely exposed to the sun. Mr. Minchin advocates partial shade, and in clearing his forest land left some of the larger trees for this purpose. Manure can scarcely be dispensed with, in his opinion, but the plant gratefully responds to every attention paid to it.

No crop for the purpose of fibre extraction should be expected until after the plant has been left in the ground undisturbed for twelve months, during which time the fields must be carefully kept free from weeds, the expense of this not being nearly so great when the ramie has thoroughly established itself. The cost of upkeep of any estate after the first year will, therefore, be light in comparison with most other crops. When in full vigour ramie in India should afford from four to five crops every year.

On ramie plantations near Zagazic, on the Suez railway, where three hundred acres of rhea or ramie

D

were cultivated, no shade was found to be necessary, and the fields were irrigated in the customary Egyptian manner. It is the practice in Egypt to cut the stems while still young and pale green in colour, and they do this because they find that when the stem once begins to change colour the bark hardens, and the resinous matter becomes stronger, and decortication extremely difficult. Of course this is so, and as the flowering stage approaches the entire structure of the plant is undergoing considerable change, which, in all probability, will to some extent affect the character of the fibre, as well as the bark and the wood. When the plant has reached its most perfect vigour, and when its component parts are at their best, the stems in Egypt reach, it is said, 8 or 9 feet in height, but they cut them when from 4 to 5 feet long, and the film of bark, which is very delicate, can easily be stripped off the stalk by hand, and one hour's exposure to the sun is sufficient to dry it for packing. When removed from the half-matured stem the bark is a thin pellucid ribbon, as translucent as green Persian silk when in a moist state. In this condition the gum is probably less tenacious, but the weight of fibre lost by premature cutting must be very considerable. The decision as to which of the two systems is the best turns on the relative qualities of filasse produced. If there is but trifling difference in the degummed fibres values, the balance of advantage must rest with the system which gives the heaviest crop.

A further estimate of the probable Indian crop may be arrived at from an interesting observation of Mr. Minchin's, who selected three-year-old plants, and on the 6th March cut them down close to the ground. On the 6th May following he cut from these three plants 62 stems, weighing in the aggregate $8\frac{1}{2}$ lb., and on the 1st July he again cut, from the same plants, 83 stems, weighing $11\frac{1}{4}$ lb.

In April stems six feet long when decorticated yielded $7\frac{1}{2}$ per cent. of their weight in ribbon, but in the rains the green stuff contained more water, and the percentage of ribbons was somewhat less. In Algiers,

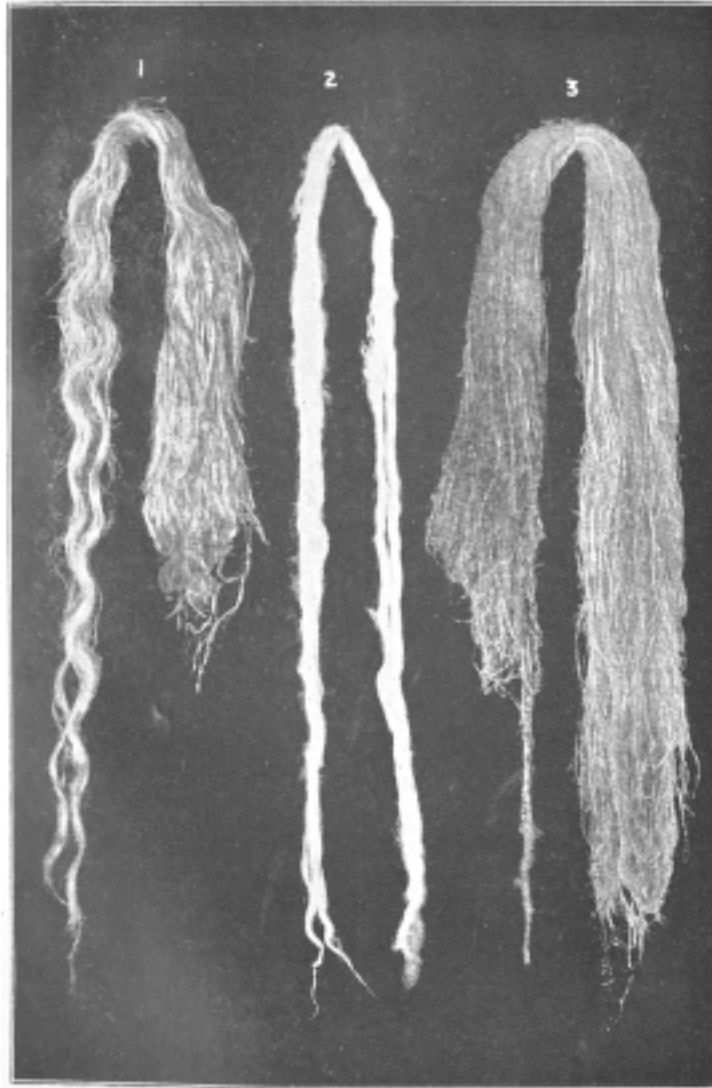

1 RAW "FIBRE." 2. DEGUMMED FIBRE.
3 RAW "FIBRE" (CLEANED).

where the ripe stems only average about an ounce and a half in weight, a yield of 10 per cent. of ribbons is obtained. Mr. Jennings says: To obtain one ton of ribbons per acre in India, assuming the percentage obtained from the bulk to be 7 per cent., it will be necessary to cut 12,000lb. weight of green stems, and assuming them to average eight stems to the pound that will be 256,000 stems; so that if five crops are obtained in the year it will be necessary to get 51,200 stems at each cutting from the acre—or per square yard (4,840 square yards equal 1 acre), say, $10\frac{1}{2}$ stems. To get two tons of ribbons per acre 21 stems must be cut from each square yard. At Glenrock, it may be stated, in many places over 30 mature stems have been counted to the measured square yard. Two tons of ribbons, he adds, is not therefore an unreasonable estimate of the probable yield of established cultivation in India. In twelve months from the time ramie seed is sown, when the fibre is raised from seed, the plants will produce stems large enough for treatment. The seeds should be sown between the months of October and March.

The fibres of ramie are finer than those of flax, and weigh lighter in bulk. The mean diameter of the ultimate fibres of flax is about $\frac{1}{2000}$ part of an inch; Assam ramie, $\frac{1}{2200}$; China grass, produced in China, $\frac{1}{2100}$; and they have been disintegrated to the extraordinary degree of $\frac{1}{8000}$ part of an inch. It has a wide range of affinity with other fibres, though it is not perfectly similar to any of them. The cells of which the fibre consists are 3 to 18 inches in length and it may be said with truth that fineness, strength, and silk-like lustre are not associated in the same perfection in any other fibre. The outside layer of the stem close to the bark is strongest and roughest, the inner layer glassier and finer. Early-cut ramie stems yield finer fibre, but in proportionately smaller quantities. In perfectly ripe stems the fibre increases in weight and strength, but diminishes in fineness and lustre. If the stems be worked up in their fresh state, and if the time of cutting should have extended over

from four to six weeks, this in itself should be sufficient to produce fibre of a different quality to that produced from the same land. Cordage spun from the fibre has sustained 252lb., as against 84lb. required by the British Government Dockyards, and it suffers little from the action of high-pressure steam at about two atmospheres pressure. Then, again, for four hours' subjection to high-pressure steam at two atmospheres the loss in China grass is 0.89; Assam ramie, 1.51; flax, 3.50; Italian hemp, 6.18; Russian hemp, 8.44; jute, 21.39. Compared with Petersburg hemp strength ratio is 280 to 160; "Bon" (wild) Assam rhea, or ramie, 343.

The rhea, or ramie, plant, it is stated by some, in order to produce fibre which will be most suitable for very fine purposes, should not be grown to a greater height than 3 or 4 feet, the superior quality of the fibre making up for the diminished outturn per acre. Fibre from the smaller stems is not only finer, but loses less in combing. The fibre yield of ramie, it may be observed, is in excess of the fibre yield of flax. Strong compact soils, even though they can be irrigated, are not suitable for its successful culture, and, though the plants prefer damp soil, marshy grounds are against their perfect growth. In permanent dampness the roots decompose and rot away. The growth of the plant generally is proportionate to the amount of warmth which it receives.

Planting from seeds, slips, or layers is not as simple or as practical as from root stocks, and is more the work of the horticulturist or the botanist than that of the agriculturist, and the latter should endeavour to raise the plants he requires, purchasing a small number to multiply in a nursery, or, still better, in the field itself that is to be devoted to their culture. A fertile piece of land should be chosen for the nursery, sufficiently damp and mellow. The fragments of roots, or broken stumps, destined for reproduction should be about four or five inches long. They must be planted in parallel lines, about 20 inches apart, each plant being about 20 inches from the next one on the same line. They

must be planted a little on one side, and in such a way that their upper end may project about three inches above the surface of the ground. A root stock planted in April and pinched off when its roots are six inches high, and then earthed up, will afford a considerable number of new plants the following spring. The ground chosen for the culture having been turned over and properly mellowed, parallel furrows should be made in which to place the plants, taking care to lay them in quincunx :.:.:. —*i.e.*, so that the plants of one row are opposite the intervals of the next row. Some advise running these furrows three feet apart, and setting the plants the same distance from each other in the furrows; but this arrangement is inconvenient, as it takes a long time before the plants fill all the intervening space, and so much land is left idle the first year. Further, the soil not being sheltered dries rapidly, and the weeds grow in perfect freedom. It is therefore better to draw the furrows only 20 inches apart, and leave the same distance as in the furrows between the plants. The number of plants on a given surface is thus quadrupled; the soil being sheltered is kept cooler; the stems being nearer to each other grow straighter; and the parasitic plants are soon smothered by the vigorous growth of the ramie. The next year, after the first crop, one line of plants out of two in each direction may be taken away. The field in which the remaining plants are about three feet apart in both directions becomes a permanent ramie field, and the roots that have been taken out and properly divided will serve to form a new nursery, occupying but a limited space, which will be in its turn transformed into a second permanent ramie field. In countries where they are accustomed to grow the vine it will be easy to add the culture of ramie, by reason of the manner in which it prospers in the shade, and it is very probable that the large amount of tannin which is contained in ramie may check the extension of the phylloxera. The ramie plant can well withstand a prolonged drought, but its external growth will languish. The more permeable the soil in which it is

sown the more frequent must be its irrigation during the great heat of summer months, but irrigation must cease a fortnight before the crop is taken in, in order to let the stems grow strong and lose their excess of water. The soil must accordingly be disposed so as to render irrigation easy. The best method is to plant the roots in shelving beds, separated by trenches, which serve not only for irrigation, but also for the escape of the rain water, and at the same time afford facilities for walking about the fields easily. Along these pathways the labourers can pass and cut the stems as they mature, carrying baskets in which to deposit the stems as they are cut. Roadways should also be made on fairly large estates for the passage of vehicles, a central roadway passing through the estate.

The leafy portion of the plant being much developed, the plant draws from the air a great part of the elements essential for its nutrition. Rhea, or ramie, is therefore not an exhausting crop, and can grow in inferior ground; while hemp and flax require a very rich soil, which they impoverish excessively. As before stated, it is not, however, inaccessible to the action of manure, and its growth will always be in proportion to the amount of food furnished to it, provided it is in assimilable form. Liquid manures should accordingly be used more or less mixed with water in the spring and after each cutting. Farm manure should never be used otherwise than as a winter covering, for then the rain and snow will disintegrate it, and cause its elements to penetrate the soil. When the plant has filled up all the spaces prepared for it, the annual labour is reduced to a single spring ploughing between the lines to clear the irrigating trenches, and a second in the autumn to earth up the crop for winter. It is only when all the subsoil of the field is permeated with their roots that these plants throw out the numerous shoots and yield the quantity of stems which constitute a first-class crop. The first crop of fibre obtained is of little or no value for textile-manufacturing purposes.

In the neighbourhood of Padua, under similar conditions of climate to those of the South of France,

14,400lb. of green stems were obtained per acre in two crops, of which weight one half was composed of leaves. The 7,200lb. of green stems without leaves yielded 1,440lb. of dry stems and 320lb. of filament; in the second year 52,600lb. of stems were obtained, including leaves—namely, 26,300lb. of green stems without leaves, 5,260lb. of dry stems and 994lb. of filament, or dry fibre; and the third year, the field being in its definite state, two crops were gathered, 64,720lb. green stems with their leaves, or 32,360lb. without leaves, 6,400lb. of dry stems, and 1,280lb. of fibre. In the South of France 1,600lb. of fibre to the acre has been obtained in two crops per annum, which is more than the best annual crop of flax.

In Mexico it is stated six annual cuttings of stems can be secured in ramie, or rhea, cultivation. Some authorities favour taking only five crops per annum, as they state that to take the sixth impoverishes the plant, and damages the quality of the fibre which it produces in the future. The cost of cultivating the fibre in suitable growing areas is agreed by many experts to be £4 per acre per annum. It can be grown in from 15 to 42 degrees latitude, and in its structure is different from flax. It is longer than any description of cotton in the staple, and was pronounced by Dr. Forbes Watson to be "the strongest fibre in nature." Stem cuttings may be well used in propagating by root suckers to fill up vacancies and increase the number of plants in the field. Rhea, or ramie, possesses remarkable properties in the manner in which it resists atmospheric influences; in these respects it is superior to any other fibre. Air and water have little influence on it however long a time it may be exposed, and it possesses a very distinct non-liability to rot when immersed in water.

Efforts have of late been made, and with very promising results, to extend the culture of this fibre in the British Colonies. In Cape Colony the climate is found not to be sufficiently warm and humid, but it is stated to thrive well in Rhodesia. In the low lands of British East Africa it is reported to grow fairly well,

and steps have lately been taken to introduce its culture into British West Africa. In Queensland it has been experimented with, and there are no doubt many areas in Australia in which it could be successfully cultivated. In Nigeria trial plantings made some two years ago are stated to have done well, though so far they have not been able to compete with the China trade; and in the Southern United States there are many districts in which it could be profitably raised. *Boehmeria tenacissima*, the equatorial plant, can also be cultivated very well in different parts of South America. It is rather peculiar in connection with this variety of the plant that a leading firm of Paris seedsmen say it does not produce fertile seed in some districts, notably Algeria. A recent report from La Cascades, near Yucand, in the Madras Presidency, states that they are growing ramie there, the variety being *Boehmeria nivea*. So far as Indian ramie culture is concerned, Sir George Watt says very definitely that the greatest measure of success will in the future be obtained in the districts where, for many centuries possibly, the plant has been grown by the people as a regular crop. These have already been spoken of collectively as a sub-montane tract that lies between $25^{\circ} 30'$ and 28° north latitude. If to this be added the Kangra Valley, the Indian area of successful cultivation is carried to the 32° north latitude. In other words the most southern extremity (Rungpur and Bogra) is approximately in the latitude of Canton and a portion of Formosa, and the most northern point (Kangra) is in the latitude of Nanking. Thus the Indian region indicated corresponds fairly closely in point of latitude to the more important Chinese area of production. In Jalpaiguri and the Duars much good ramie land is no doubt available, and in these districts the labour question would very possibly be much less serious than in Assam, though the climate of Upper Assam would seem by far the best suited to the plant. The backwardness of Burma, especially within the Shann States, where this plant is regularly grown, will very possibly stand in the way of this country being taken into

immediate consideration by intending planters, though within the last few years, from what the author has learned from those who have lived in the country, it is progressing out of this condition. Outside the districts of existing ramie cultivation, Sir George Watt adds, Kangra would seem in point of locality and climate the most hopeful. The plant has been shown to give there a very much higher yield than in the districts of South India, where fairly extended experiments have been conducted. The cultivation of a few hundred acres of land in Rungpur, in the Duars, in Sibsagar, in Lakhimpur, in Upper Burma, and in Kangra systematically for a term of years would, in his opinion, decide definitely what profit is to be made by ramie culture in India, and as the great merits of the fibre become recognised it should command higher prices from spinners than those at present offered. Four good cuttings should be obtained from the plant per annum to make culture pay, and the total weight of these four cuttings of stems should not be less than 30,000lb. per acre, say 15 tons. At a $2\frac{1}{2}$ per cent. fibre yield, which is a low one, this means obtaining 750lb. of dry fibre per acre per annum.

On maturing the plant must be stripped of its leaves on the field while standing, and the stems then cut as close to the ground as possible. When the plant has been cut and the new shoots from the roots make their appearance, the land should be at once well ploughed between the rows. No ploughing must be done while the next growth of the plant is taking place; this would break the new shoots and interfere with the proper growth of stem.

From time to time the upper surface of a stool should be sliced away immediately after a crop has been harvested, and so the woody matter on the surface of the stool will be removed. These are the stumps of previous cuttings. Stems shooting from these where they have kept green are never satisfactory, growing only to $2\frac{1}{2}$ feet.

Mr. Coventry says that if 750lb. of dry fibre can be obtained from each acre cultivated per annum, it will

show the planter the profit of £3 an acre before referred to, and if on the market cordage fibres like Manila and Aloe fetch any price from £30 to £50 per ton, flax from £40 to £100 per ton, jute (which is a very inferior fibre), £22 per ton, ramie, he considers, should command a better price from the spinner. The above yield has been obtained over a small acreage in Behar.

The foregoing chapters would not be complete without referring to the further opinion expressed by Sir George Watt in respect to the value and possibilities of the "bon," or "ban," (wild) rhea, which, he states, yields a fibre of great merit. It is met with plentifully at the foot of the eastern Himalaya, from Sikkim to Nepal, throughout the Valley of Assam, especially near the foot of the hills, and distributed within the Assam hills from the extreme north through the Naga country to the Khasia and Garo Hills, thence to Manipur, Cachar, Sylhet, and Chittagong, also the mountainous tracts of Burma (as far as Tenasserim), and to the Yunan Province of China. It occurs again in the damp valleys of the higher Konkan Ghats, and is distributed to the Andaman Islands. It is found principally in damp glades near streams, but with its roots above water-level, and is often so extensively pollarded that it resembles in some respects a large-leaved willow. Riha-kata-jan, in the Nambar Forest, is the centre of the Mikir collection and preparation of the "bon," or "ban," riha fibre. This is purely an indigenous plant, but because of its being called "ban" (wild) rhea, arose the very mistaken notion, by writers who had very possibly never seen it, that it was the wild plant from which by cultivation the rhea, or ramie, of commerce had been developed, and the still greater error that seeing that rhea, or ramie, was thus wild in India the fibre could be procured for little more than the cost of cultivation. Neither Jenkins, Hannay, nor Dalton have ever stated they found *Boehmeria nivea* wild, but are most careful to mention that the "ban" riha (or so-called wild riha) plant is perfectly distinct from the cultivated rhea, or ramie, of commerce. It is a small evergreen tree, or large bush, which, when

pollarded, produces many erect straight branches, 5, 10, or 15 feet in length. Leaves 6 to 14 inches long, elliptic, oblong, caudate entire, or when young obscurely crenate, pinninerved (8-15 pairs), membranous and tomentose, the leaves of staminate plants, much more velvety than of the pistilate petiole, 1 to 16 inches long, stipules silky villous. Flowers very minute, the males (staminate flowers) on one plant and the females on another, clustered on small dichotomously branched cymes that are situated on the lower portions of the branches below the leaves, or around the scars of fallen leaves, male clusters considerably longer stalked and more open than the female, male flowers 3 to 4 merous, the perianth adnate to the ovary, and to the achenes. It is a jungle plant common in most of the Indian forests. When unmolested it grows to a tree, but by proper management any quantity of young shoots can be obtained, and as the divided roots afford numerous shoots, and the plant can be propagated by slips as well as by seed, its cultivation for its fibre might be carried on in the same manner as practised in Europe with the willow. It is cultivated largely by the hill tribes in the north-west of Yunan, and by the Singhpors, and Dhoanneas of the North-East Frontier to a small extent only, for a coarse cloth, but chiefly for nets. It is called *Leepeeah* by the Nepalese. It has been stated that the fibre is all that can be desired for either canvas or lines, and only requires to be known to be generally used for these purposes. Dr. Royle gives the following table of comparative strengths of fibres:—Petersburgh clean hemp, 160lb.; Jubbulpore hemp, 190lb.; China grass, 250lb.; rhea, or ramie, fibre, 320lb.; “ban,” “bon,” or wild rhea, 340lb. From this table the “ban” rhea is the strongest of all.

Sir George Watt some time ago invited Mr. J. Melrose-Arnot, chemist to the Bally Paper Mills Company, to examine and report upon a small sample of the ribbons of bark which had been roughly stripped by him from a few branches cut from a plant found on the sloping banks of the Rajghur Ali (an elevated road), near Lackwah, Sibsagar. These ribbons were not scraped or put

through any process of preparation, the object being to secure the entire ribbon (strip) of bark fibre and gum simply dried in the shade. It was a male tree in full flower. The tree had not been systematically pollarded, and the shoots were old, fully ten feet long, and an inch or more in thickness at the bottom. The season of the year was, moreover, an Assamese attendant said, not the correct one. The shoots then on the tree should have been taken off and rejected, and the young shoots that would be found on it in June to October alone collected for fibre purposes.

It is necessary, in considering Mr. Melrose-Arnot's report, to make allowance for these unfavourable circumstances. Mr. Arnot wrote: "The following figures are the result of my chemical analysis:—

Moisture.	Cellulose.	Mercerisation.	Nitration.
11.45	26.01	16.40	129.29

"The fibres are beautifully white and of a fine silky lustre, measuring 25 to 30 mm. long and only 0.013 mm. in diameter; they are cylindrical, or nearly so, with a slightly striated exterior thick wall, and small central canal, ends tapered. A pecto-cellulose very similar to flax, but much finer, while being equally long.

"As compared with *Boehmeria nivea*, this is exceedingly fine; indeed it is one of the finest fibres I have ever measured, and although not anything like so fine in the individual fibre the filaments are long and strong, and I have no doubt that in every respect the material would prove more easily workable on textile machinery. It would undoubtedly make very much finer textures than *Boehmeria nivea*, and it ought to be the most perfect substitute for linen."

Mr. L. A. M. Lumsden, of Nahor Rani Tea Company, Tezpur, was also requested to go into the question of an experimental cultivation of this plant, and did so. He furnished the following particulars:—

Weight of green branches	..	36 maunds	32 seers.
Weight of green ribbons	..	3 "	30 "
Weight of dry ribbons	..	1 "	30 "

These figures may therefore be accepted as indicating

the yield of dry fibre to the weight of green shoots which this plant affords.

The Nagas are conversant with the methods of its cultivation and cleaning.

Mr. John Phillips, of Suffry Sibsagar, says: "I take the name bon riha, or ban riha, or wild rhea, to be applicable to the fibre, not to the plant from which it is obtained. The plant is called 'Bon Kot Kora,' but whether this is Ahom or Hinduised Assamese I cannot say, nor can I explain why it is called Wild 'Kot Kora.' The Singpho Doanneas call the plant 'Lookey Khoon,' the latter word meaning tree or plant, and the Nagas in this country call the plant 'Jutta.'"

Note should here be made that cultivators in Bengal and Assam often call *Boehmeria platyphylla*, a plant which abounds as a weed almost everywhere around enclosures where *Boehmeria nivea* is cultivated, and which yields only a very inferior fibre, wild riha. The two plants have, however, nothing in common. In this species the leaves are green below with the veins very often pink, and in regard to shape they are by no means unlike the leaves of badly grown *Boehmeria nivea*. These characteristics will serve to distinguish this comparatively worthless fibre plant from *Boehmeria nivea* and "bon," or "ban," (wild) rhea.

Mr. F. E. B. Lloyd, Officiating Deputy Conservator of Forests, says of the ban rhea: "I have studied the habits of this plant during the cold weather. Left unmolested it attains a girth of about 2 feet and a height of about 30 to 40 feet. In the Garo Hills, or rather on the hills bordering on the Khasia and Garo Hills, it is found, and extends all along the southern boundary, and is very fairly common. It is not gregarious, and it does not grow at all on the plains, or in places exposed to the sun. The tree flowers in March, and the seed ripens in April. The method of obtaining the branches which yield the fibre of this tree is to pollard it between the months of November and February, when the young pollarded shoots will be available in June and throughout the rains. The fibre

is extracted from the branches in exactly the same manner as from *Boehmeria nivea*, only the fibre is longer." One man, he adds, preparing ban riha can get as much fibre in the same time as three men preparing the cultivated fibre. The people use it for making nets and mixing with silk, and it can sometimes be bought in the village markets, where the Garos, who principally bring down the fibre, sell it at R.1 per seer.

Mr. Phillips procured a set of Jabaka Naga shoulder bags woven from this fibre. It is specially selected for this purpose on account of the great strength of the textile. These bags are somewhat coarsely woven, but often very neatly embroidered, and the Nagas state that the "bon," or "ban," riha takes dye very readily. It is said that rhea when made into fishing lines is apt to get knotted when thrown from the rod; if mixed with bon riha this does not occur.

From May the plant (bon riha) begins giving out its light green shoots, which alone are used for the extraction of the fibre. The Nagas call the plant "ritza," or "rice" for short. Where it gets a loose soil and plenty of water it thrives, and they produce the ribbons in a different way to that followed by the Assamese. The cuttings are best made from May to October, during the rainy season. The quality of fibre depends on the age of the shoots. In old shoots the fibre is less abundant, and is not so strong, as it is largely intermixed with hard woody or lignified tissue. The younger the shoots, therefore, the better will be the quality of the fibre. After cutting the shoots are carried to the villages, where the outside green skin, or bark, and a little slimy matter, are scraped off; then the ribbons of partially cleaned fibre are stripped off the shoots. The inside of these strips of fibre is then scraped with the knife so placed in the hand as to allow the edge to rest against the forefinger. The strips are then drawn through repeatedly in order to remove the slimy and gummy substances from the inner face of the ribbons. After being as well cleaned as possible in this way the ribbons of fibre are left

to dry, not in the sun, it must be noted, but in the shade. After being fully dried the ribbons next are steeped in water and wood ashes for about 24 hours, and then boiled in rice water for four hours. The fibre will then be found to be quite free from gum, and may be separated into fine threads. This is mostly carried on in the villages by the old people. The Nagas believe that the harder the thread is spun the stronger it becomes.

The Assamese take off the ribbons when the shoots are in a half-dry state, and do not first scrape off the outer bark or gum. They also leave the inner face coated with the slimy gum. They purify it in a coarse way by washing in lime, and then twist it into twine, or simply divide up the ribbons, and without any preparation twist these into twine to be used for making nets to catch deer in. The Assamese do not spin or weave this "ban" riha, or rhea, which must not be confounded with *Boehmeria nivea*, nor do they even make fishing lines and nets from it; for this purpose they prefer the last-named fibre, the true rhea or ramie.

"Ban" riha will not grow where water stands. On the embankment of the Rajghur, from whence the sample for analysis was taken, it was naturally dry, though water was plentiful below.

The "bon," or "ban," riha, or rhea, is a plant that can be grown on soils that *Boehmeria nivea* cannot live upon. It requires next to no cultivation. There is no difficulty in separating the ribbons of bark since they do not adhere very firmly to the centre core of wood, and Sir George Watt says the fibre-yielding bark strips off like that of a willow, and in his opinion a machine that would slit the bark and then peel it off might easily be devised. Once so stripped the ribbons could be laid flat on a feeding table and scraped both top and bottom without injury to the fibre. The gum can be easily removed in this way, and it is not so very abundant nor difficult of removal. The fibre, he adds, could be produced as a by-crop in tea planting, easily and cheaply cleaned, and thus turned into the market at a price that would command a ready sale,

and from what he knows of this wonderful and greatly neglected fibre he has little hesitation in affirming that the tea planters in Assam might find the "bon," or "ban," riha a more tractable and remunerative by-crop than rhea fibre itself—that is, *Boehmeria nivea*. It could be cultivated on the sloping banks of most of the depressions, or hullahs, within the tea estate—lands which at the present time are not merely waste, but often sources of positive danger to the tea plant. The annual crop of shoots from these perennial bushes would be found money, and the supply of ribbons could be scraped by hand labour at a very moderate cost; the total charge indeed against establishment until a machine could be devised to greatly reduce even the cost of separation and cleaning, which should not, as before stated, prove a difficult task for the machinist.

Sir George Watt presumes in his remarks the possibilities of the fibre extracted from the "bon," or "ban," riha, or, as it is often called, wild rhea, being even considerably less valuable than that of the true rhea, *Boehmeria nivea*. The writer recently received from the Economic Products Department, Calcutta, a sample of this fibre, which had been cleaned, and submitted the same for examination and analysis to a chemist who has had considerable experience in the degumming of both *Boehmeria nivea* and *Boehmeria tenacissima*. In his opinion it would not degum with any more appreciable ease than effectively decorticated rhea, or ramie, or hand-cleaned China grass does in ramie-spinning districts, though in the case of treating it on the land on which it was grown it might prove somewhat easier to deal with. So far as the quality of the fibre itself is concerned, this, in his opinion, while not equal in value to the fibres of either *Boehmeria nivea* or *Boehmeria tenacissima*, is yet a very valuable fibre, which should easily be turned to very profitable commercial use.

The value of the textile fibres of *Boehmeria nivea*, and of the "bon," or "ban," riha, or rhea, to British trades arises in the fact that their use should supplant

that of higher-priced foreign flax. In regard to the former, from what Sir George Watt states, it has not yet been endeavoured to grow this plant in those districts of India where it might be able to yield, say, $\frac{3}{4}$ ton of dry fibre to the acre cultivated annually; therefore, the record of Indian attempts at ramie cultivation, save in the case of the Kangra Valley, read somewhat disappointingly. This circumstance must be borne in mind. In respect to the "bon," or "ban," riha, or rhea, it has not been attempted to cultivate this anywhere in the Empire, yet we have the highest authority for believing that its fibre is almost equal in value to that of China grass, and that its machine decortication could be easily arranged for by any average intelligent engineer, presuming the methods for the machine decortication of *Boehmeria nivea* and *Boehmeria tenacissima* are not before long rendered absolutely perfect, which the author, however, thinks is scarcely likely to prove to be the case. A large and very profitable trade in China grass is being established on the Continent of Europe without doubt, and the question is from what portion of the British dominions can fibre produced from *Boehmeria nivea*, the variety of rhea cultivated in China, or *Boehmeria tenacissima* (ramie) be obtained which will prove cheaper for the rhea, or ramie, spinner, with a perfect plant and machinery, to use in place of China grass imported from China, pay the grower a fair profit, and bring about the utilisation of the fibres generally in British trade, instead of foreign flax, for many manufactures. While it must be admitted that lands, no matter how naturally fertile, cannot, even in the climates most suitable for the products which it is desired to raise upon them, be made to yield more than certain maximum crops, yet it is a well-established fact that, as in the case of jute for example, if the culture of the special product which it is sought to raise be studied in a careful manner, and the most up-to-date system in cultivating pursued, lands may be made to yield crops to an extent previously deemed impossible. This has been proved in many instances. Much has

E

of late years been accomplished in this direction by the use of low-priced artificial fertilisers for the soil, which are now largely manufactured and easily obtainable, and their use might be adopted with excellent results by those experimenting with rhea, or ramie, in the particular districts in India in which Sir George Watt, as the result of his investigations made some little time ago, states it is alone practical to look to achieve the results desired, and in such other areas in the British Empire as evince a tendency to grow the plant for fibre purposes successfully. Mr. R. G. Finlow, Fibre Expert to the Government of Eastern Bengal and Assam, intends shortly to inquire more fully into the suitability of Assam for ramie culture. Where the rainfall is less than 45 inches ramie culture should not be undertaken in India.

Having now dealt with the peculiar characteristics of these three valuable varieties of the *Urticæ*—namely, *Boehmeria nivea*, *Boehmeria tenacissima*, and the *Villebrunea integrifolia*—or “bon,” or “ban,” riha, or rhea—the methods of their culture or condition of natural growth, and the separation and hand-cleaning of the fibre as practised by the natives in India, the methods of manufacture can be described; and in regard to these it may be said that, like the processes of other industries, they are the subject of close daily study and improvement, the good results of which are being experienced in a very considerable and profitable extension in the trade in ramie textiles in France, Germany, the United States, and the United Kingdom, especially.

With regard to the trials of decorticating machines instituted by the Government of India in January, 1870, these were duly held at Saharanpur, but no machine or process was submitted which was considered entitled to the bonus offered, although a grant of £1,500 was made to Mr. Greig, of Edinburgh, for a machine which he submitted, and which was considered the best attempt made to solve the problem. The Government renewed their offer a second time on the 31st August, 1877, and in a later resolution, dated March 19, 1881, reviewed the report of the Trials Committee, with

the result that, by reason of the low value placed by English firms on the samples of fibre produced at this competition, they withdrew the bonus offer. Since then the question of decortication has come in for more technical attention, and so the above is past history of no moment.

CHAPTER IV.

The Decortication of Rhea, or Ramie Fibre.

As already stated in the preceding chapters, rhea, or, as it may be termed, ramie, fibre, by both of which names the fibres of *Boehmeria nivea* and *Boehmeria tenacissima* are known in commerce, they being given to them indiscriminately (although it is more correct to designate *Boehmeria nivea* the Chinese, "rhea" the Indian plant, which title has been adopted for it apparently by the Government of India, and *Boehmeria tenacissima*, the plant found in Malay and equatorial regions, ramie), would have been far more widely cultivated and used in commerce to-day than it is but for the difficulty which arises in removing by other than hand means all the woody parts from the green stems, the outer skin, or cuticle, and as much as possible of the juice of the stems, so as to simplify and cheapen the degumming process later (to which reference will be made further on), without damaging in any way the valuable textile properties of the fibres. Could this be accomplished with economy and effectiveness by means of machinery, then the trouble which attends the preparation of these fibres for the market would disappear, and they would be easily obtainable in regular adequate quantities by textile manufacturers at moderate prices. It is a strange circumstance, when the progress in engineering science of the last fifty years is taken into consideration, that this problem has not several years since been solved satisfactorily, instead of its solution practically being postponed to within the last three or four years. This would likely have proved to be the case but for the fact that all inventors who have turned their attention to the subject since

it first came to the front have concentrated their efforts on the construction of machines which, acting on the stems of the plant, would remove the bark strips from them in the form of the ribbons. It may even be the case, and very probably is, that from among the numerous patents which have been granted for ramie decorticators, machines may be found which perform this operation in a fairly satisfactory manner, but it must be borne in mind that it is only, save in two or three instances, within comparatively recent years that the chemist has been able to exercise his skill in such a manner as to extract the fibres from rhea, or ramie, ribbons without damaging the strength and other good qualities of the fibre. Accordingly, even if in past times machines have been constructed which produced a fairly-well cleaned ribbon with but little loss of fibre, the processes then in existence for degumming the fibres were not able to extract them from these without damaging their good qualities to a greater or less degree, which caused the product to fail to be appreciated when, in the form of fabrics, it was sold to consumers. Further so much needless waste occurred in the methods adopted for preparing and spinning the fibre that the prices which manufacturers were compelled to ask for the yarns and fabrics were too high to lead to its extensive use, and lower ones would have resulted only in heavy losses upon a large turnover so far as he was personally concerned. These circumstances had a very discouraging effect upon the efforts made in Great Britain in the linen, silk, and other districts, and enterprises formed to manufacture ramie were abandoned by their founders. Not so easily discouraged, however, were the French and German machinist and merchant in their determination to turn the product to profitable account on the markets of the world, and so to-day there exist large ramie factories in these countries, where yearly profits are being made, which, in their size, are a source of the most undisguised surprise to the British manufacturer and merchant, who are only now beginning to awaken to a knowledge of the existence of these circumstances.

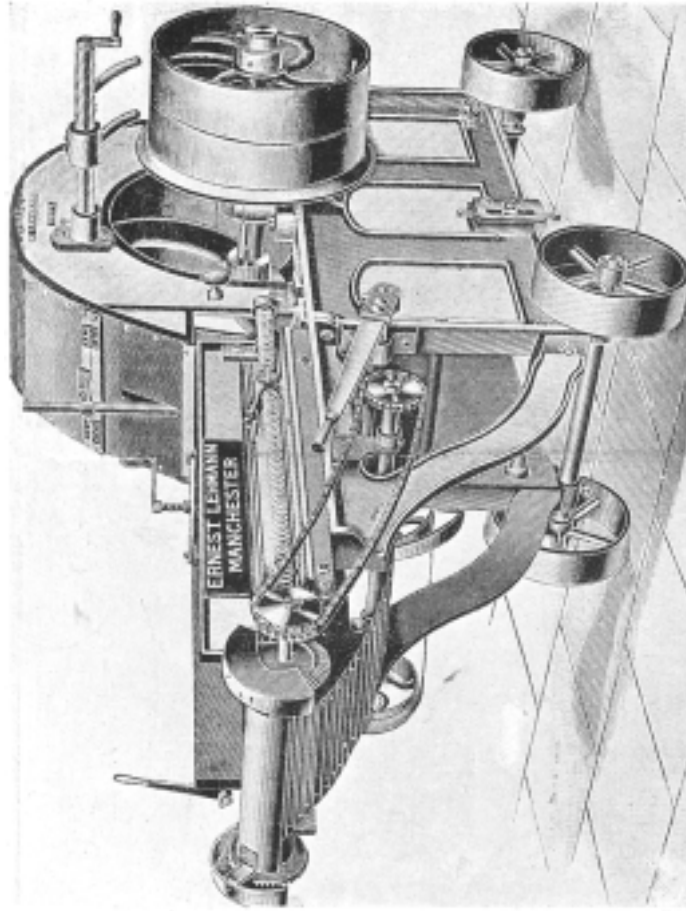

LEHMANN'S DECORTICATOR FOR RAMIE FIBRE.

We give here an illustration of a machine made by Mr. E. Lehmann, of Manchester, England, an engineer who has devoted several years to the study of a means for decorticating such fibres as aloe leaves, henequen fibre, sisal hemp, Manila hemp, and rhea and China grass, which, he observes, when properly grown, may not only be twisted into strong roping, but also manufactured into a large variety of other useful goods, such as coarse fabrics, mattings, etc., which are not only very durable, but are not unseemly in appearance. He makes a stationary machine for use in factories permanently, and also one constructed on wheels, so as to be readily transported from one centre of operations to another. They are capable of dealing with a fairly large quantity of leaves or stems daily, and are equipped with automatic feed and delivery motions. They may be driven by steam, water, or cattle power, and one is for hand-power only. One machine, while possessing the same features as the other two, is particularly adapted for the treatment of rhea, or China grass.

Ramie ribbons or bark strips will always be unsatisfactory to use for degumming, and their use in ramie mills is behind the times. In time they will disappear. The buyer cannot test their value readily—the quality and percentage of the fibre, and whether or not it has been damaged by the decorticating machine—so he has an objection to an article which he is unacquainted with. Further, they cannot be highly compressed and packed into proper bales as other fibres are, and, as before stated, they contain a large amount of waste, on which freight has to be paid. A machine has within recent years been constructed by a French engineer, M. Faure, of Limoges, which is entirely new in principle, and most undoubtedly correct. This is designed not to produce ribbons, but fibre equal to hand-cleaned China grass imported from China, at one operation. The objective is entirely new, and novel, as compared with any efforts which have been made in the past to accomplish successfully by machine treatment the extraction of the fibres of rhea, or ramie. A full description of this machine, therefore, and an account

of what it has actually accomplished, will be of the greatest interest and value to textile manufacturers generally. It cannot be admitted yet that it is all that can be desired. Certain improvements have still to be given effect to, but viewed in the light of what it has practically performed, it must on all sides be admitted freely to constitute a very great step forward in the direction of solving this long-existing problem, as compared with any of its predecessors, and so become the means of bringing this fine fibre into general profitable use for textile purposes. It is simple, inexpensive, and strongly built so as to stand the wear and tear of plantation use without getting out of order.

The machine is intended to be worked by two men, and it is fed by the insertion of the rhea, or ramie, stems in lots of about ten stems at a time. The stems are used in the same condition as when cut, having the leaves on. The operation of feeding is as follows :— The stems are passed in twice. They enter the machine butt ends first, and having been treated about six inches of their length they are withdrawn (an operation which is easily accomplished) and fed in a second time, on this occasion the leaf ends first so as to complete the operation. The machine frees the stems from all woody matter, and from the outer skin or cuticle, and extracts a large portion of the juice, in this way producing rhea, or ramie, fibre, retaining all its valuable qualities. Its weight is 11 cwt. It consists mainly of the framework and driving-gear, the decorticating drum carrying beaters, and the feed-bed. This latter is the important feature of the machine by reason of its special general outline, which varies at different parts to suit the various descriptions of work which the machine has to perform. The first part of the bed is curved outwards, the second is straight, and the third is curved inwards. The ramie stems are fed into the machine over the first part of this bed, where the woody portion becomes immediately broken, and partly removed. The strip passes on then to the second part, and as the speed of the beaters is considerably greater than at the part at which the stems are fed into the

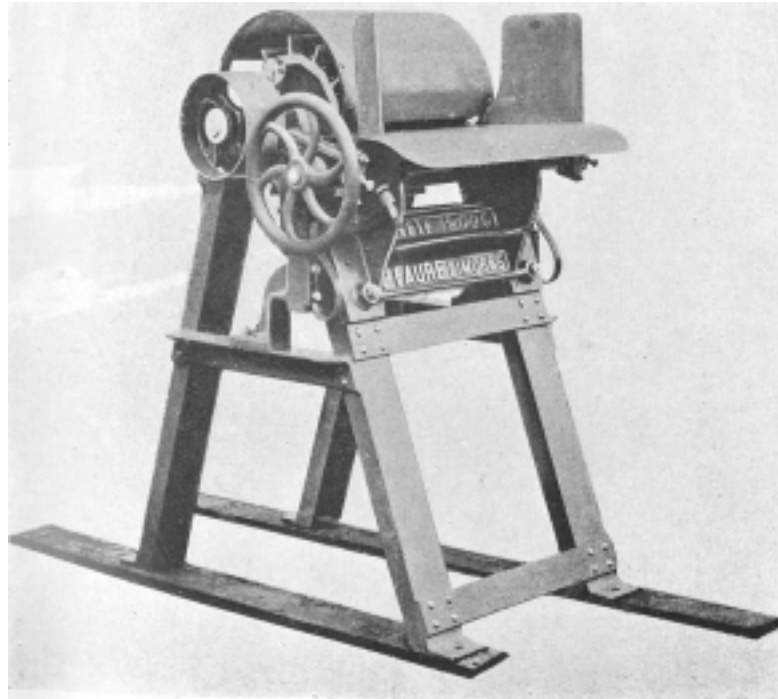

FAURE'S DECORTICATOR FOR RAMIE HAND-MACHINE.

machine a scraping effect is produced on the strips, the distance between the beaters and the surface of the bed being less than the thickness of the rhea, or ramie, strip. This scraping action effects a double purpose—it attacks the outer skin and also all matters extraneous to the fibre. The strips, or stricks, of filament then pass down vertically into the machine, and the separated matters—namely, most of the woody parts, the skin, and gummy substances—are thrown out to a distance by the centrifugal force of the beater drum. When the stems have entered to within a short distance of their end the return movement is effected, and they are withdrawn. During the withdrawal the following action takes place:—At the inward curve, or third part, of the bed the filaments, or fibres, are slightly and gradually grazed by the beater blades, which throw out the coarser of the debris still adhering. This operation is performed with great delicacy. The fibres assume the position of the chord of the curve, and are constantly agitated by the beaters. When the fibres arrive at the second part of the bed, as the space between it and the beaters is infinitely reduced, the entire removal of matters still adhering to the fibres is effected, and these leave the machine white, parallel, and free from woody matter, from skin, and from the major portion of the juice. The concave bed, or breast, is mounted in such a way that its position to the action of the beaters is easily regulated. The brackets which carry the bed are supported by special spring cushions and flexible legs, the object being to obtain a rubbing action between the beaters and the fibre, and having for its special object the loosening and removal of the skin, or outer cuticle. The elastic bed gives way, or vibrates, an enormous number of times per minute, and this produces the described rubbing, or “knuckle-joint,” action between the beaters and the fibres on the bed. The shape of the feed-bed causes it to remain clean and free from extraneous matter through the action of the beaters. Choking is thus rendered impossible. All abnormal strains are avoided, and the machine can be kept at work from

morning until night without stoppages from cleaning. The refuse falls underneath the machine, and is removed from time to time. In the case of a number of machines working together an endless band, or conveyor, passing under the machines removes the refuse continually, and so keeps the neighbourhood of the machines perfectly free from it.

The machine is capable of being easily worked by native labour in the ramie plantations, or in works connected therewith. Here it may be noted that although it is simple it needs to be constructed with the greatest accuracy in order to ensure effective working. The cylinder carrying the steel beaters is perfectly balanced and accurate in its action, and runs at 250 revolutions per minute. The surface of the beaters is perfectly parallel with the setting of the feed-bed, and capable of working close up to it, say to within a distance equal to the thickness of a piece of writing-paper. The feed-bed, the varying profile of which is of such enormous importance in the efficiency of the machine, is made with the greatest of accuracy by special machinery.

With regard to the production, practical experience shows that one machine worked by two men can treat 360lb. of fresh green stems per hour, or about 32cwt. per day of ten hours. The amount of dry fibre produced depends largely on the nature of the stems, and the percentage of fibre contained in green stems varies very much according to circumstances. On a 5 per cent. basis the net production of dry fibre of each machine per day of ten hours is 180lb. When the stems are specially good 200lb. of dry fibre has been produced per machine in ten hours. Under ordinary circumstances a production varying from 160 to 200lb. of dry fibre in ten hours per machine may be expected. Each machine requires about 1 indicated horse-power to drive it. When a number of machines are working together less power will suffice—thus, 8 horse-power will drive ten machines.

Owing to the quantity of fibre which is broken and cut away in the rough process of decortication, only $2\frac{1}{2}$ per cent. can be absolutely relied upon as the average

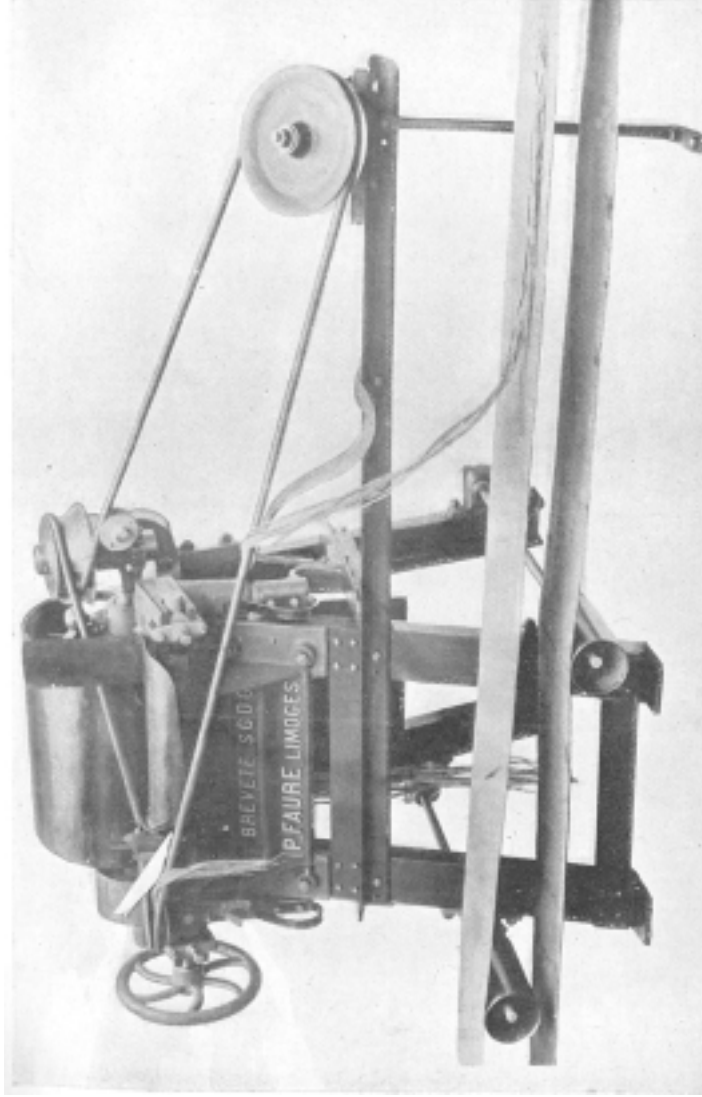

FAURE'S DECORTICATOR AFTER TREATING RAMIE STEMS.

yield with existing decorticating machinery; and Mr. Coventry says that from his experience with the Faure machine it averaged $2\frac{1}{2}$ per cent. out of a theoretical yield of 5 per cent., but the perfection of this machine he regards as only a matter of time. Behar, where his experience with the machine was gained, is not one of the best growing districts, however, and elsewhere the yield may be larger.

This machine produces a fibre which ranks in the market with China grass, by reason of its regularity in condition and quality. The buyer can easily see and test what he is buying. He is therefore able to give the rhea, or ramie, its proper classification, and pay its full market value to the exporter who has grown and decorticated it. In addition to which, by reason of the bales being well pressed and containing little else than ramie fibre, the freight and expenses per ton which he has to pay are reduced to the minimum.

The machine has worked during all seasons of recent years in the presence of experts and fibre growers, and in each season it has never failed to treat less than two crops. The fibre obtained has proved, after degumming and combing, to be equal to China grass.

The process of decortication is the first which the green, rhea, or ramie stems undergo after being cut down. It does not, strictly speaking, belong to the manufacturing branch, being more an agricultural operation. It has a most vital effect, however, on subsequent manufacturing processes. A really good rhea, or ramie, decorticator should, in dealing with the green stems, produce from them a fibre of equal value to that produced by the most expert hand labour in China. The fibre requires to be freed from shieve or wood parts, the outer skin of the stem must be entirely removed, and the minimum of gum only left in the fibre. China grass (ramie which has been decorticated by hand labour in China as a rule contains gum equal to about 30 per cent. of its weight, but experts are agreed that a good decorticator ought not to leave more than about 20 per cent. of gum in the fibre. When the fibre is thus freed from the shieve, or wood, and the

skin, together with the greater part of the gum, the degumming process afterwards is naturally rendered easy, short, and cheap).

The machine must not bruise or break the fibre, nor shorten it in any way. As with other vegetable fibres, the great desideratum is that the spinner should obtain, after he has submitted the rhea, or ramie, to the combing process, which will be referred to later, the maximum quantity of long fibre (top), which is the most valuable and profitable to spin, with the least possible amount of short fibre (or noil), which is the least valuable. When China grass is combed on a first-class combing machine 70 per cent. at least of top should be obtained, and the balance will be noil—*i.e.*, 30 per cent. or thereabouts. It is stated that ramie from China has been combed so as to give 81 per cent. of top, and leave but 19 per cent. of noils. When the fibre is badly decorticated there is accordingly a great loss of long fibre experienced, sometimes only from 30 to 50 per cent. of long fibre and 50 to 70 per cent. of short fibre being obtained. This is bad for the spinner, and renders it difficult, and at times impossible, for him to make a profit on his contracts. The processes of decortivating, degumming, and combing are therefore most closely connected together, and until the decorticated fibre has passed through the two last named, the merits of the decortivating machine made use of in its production cannot be ascertained. No opinion on the point can be formed from the mere appearance which the fibre presents. Spinners of rhea, or ramie, are therefore very chary in regard to purchasing the product of many decorticators, and naturally so, as they are often involved in heavy loss by so doing. This accounts for the general marked tendency which spinners of the fibre manifest to purchase for their raw product China grass from China, where it is prepared by hand, in preference to machine-decorticated rhea, or ramie, from India or elsewhere.

M. Faure has built several decortivating machines, each showing marked improvement on its predecessors,

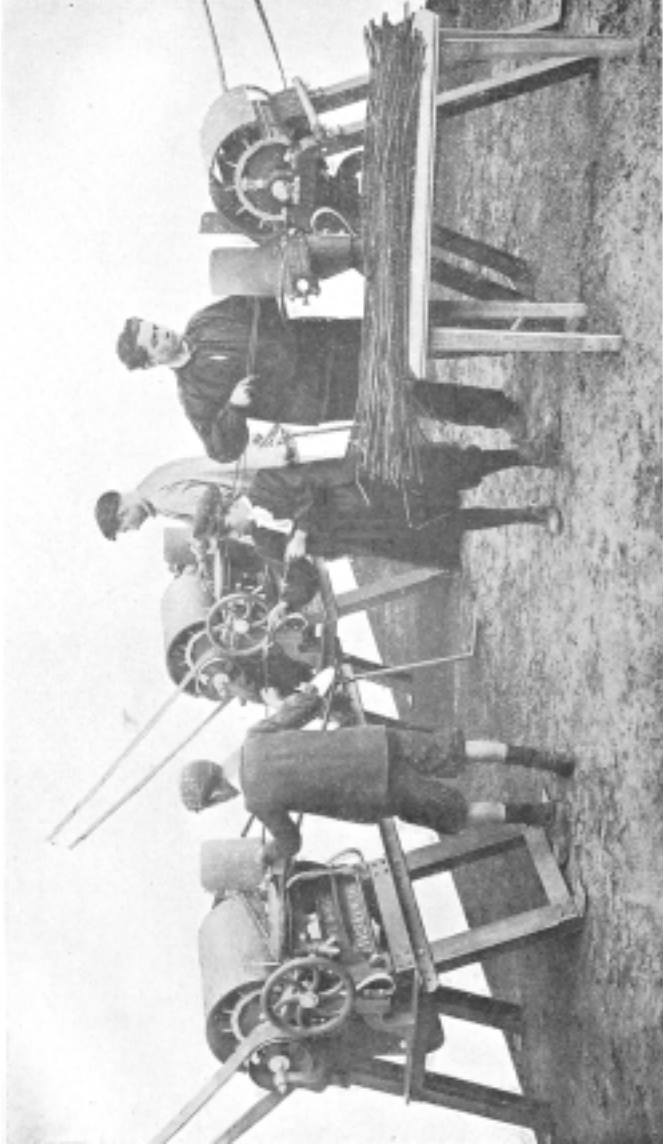

THE "FAURE" DECORTICATOR WORKING ON RAMIE STEMS IN SETS.

and is at the present time experimenting with a view to giving effect to further ideas which he has on the subject. The prices of his machine are: No. 1, £35; No. 2, £56; No. 3, £236.

By some it is argued that the production of the machine is not large. However, what the machine does produce are not bark ribbons, but is fibre equal to China grass. In this respect in all probability progress will be made. It may be remarked, however, that if the ramie grower adopts the custom of cutting the stems of the plant daily as they mature, as before advised, not only will he obtain a uniform and better fibre, but, if the decorticating machines are kept at work treating the stems daily as they mature, a few such machines as the Faure should be able to treat the annual crop of many acres easily. On the other hand, if the crops are cut at the one time there will be a far greater amount of stems to be dealt with, necessitating the employment of a greater number of decorticating machines, and the fibre obtained will not be so valuable. The machines further would be forced to stand idle for weeks together from time to time during the year on the plantation, and a machine when kept as constantly as possible at work is less liable to rust and depreciate.

M. Faure has, for the purpose of experiments with this machine, cultivated ramie at Limoges, and some years ago, when the crop was almost ready for decortication, the representatives of a number of firms engaged in growing and spinning ramie inspected the machines at work extracting the fibre from the green stems and tested the product. The questions were put to them: Is the fibre produced by the machines equal to ramie fibre decorticated by hand in China? Is the construction and working of the Faure machines satisfactory? Is the mechanical decortication of ramie a success? And after discussion in French the following resolution was unanimously adopted and signed: "The undersigned present at the trials made by M. Faure, with his new machine for decorticating ramie, or rhea, are pleased to declare that the results obtained have

completely satisfied them. Their opinion is that the decortication of ramie by the Faure machine is quite equal to that done by hand. They express their opinion that the problem of mechanical decortication is now solved under conditions absolutely satisfactory."

In a letter dated Pusa, 13th May, 1908, Mr. R. G. Finlow, B.Sc., F.C.S., Fibre Expert to the Government of Eastern Bengal and Assam, writes as follows to the Director of Agriculture, Shillong, in regard to the decortication of ramie by the Faure decorticator:

"Regarding the Faure decorticator, this is the machine which was used on ramie lands at Dalsinghsara. It is difficult to give an absolutely definite opinion regarding the machine, because the climatic conditions of Behar are not best suited to the growth of the ramie crop with which it had to deal.

"The following objections are apparent:—

"The necessary waste involved in working (average 14 per cent. of the total fibre).

"The apparent inability of the machines, especially the larger ones, to deal economically with short stems.

"These objections probably apply to a greater extent to other fibre machines in the market, but the fact remains that they are still serious in the Faure machine.

"The last objection is specially serious in Behar, where probably the greater proportion of the stems are too short to be treated economically. The yield of stems per acre is thus so seriously curtailed that while it is just possible that rhea cultivation might pay in Behar if a method of fibre extraction could be involved which would deal with all the stems, long and short, it has been found hopelessly impossible with the use of the Faure machine.

"Shortly, therefore, it may be said that while the Faure machine is a distinct improvement on other machines of the same kind, it is nevertheless open to the serious objection that it cannot deal economically with short stems, and that even with the largest and best stems about 14 per cent. of the possible yield of fibre is lost. Success can therefore only be hoped for

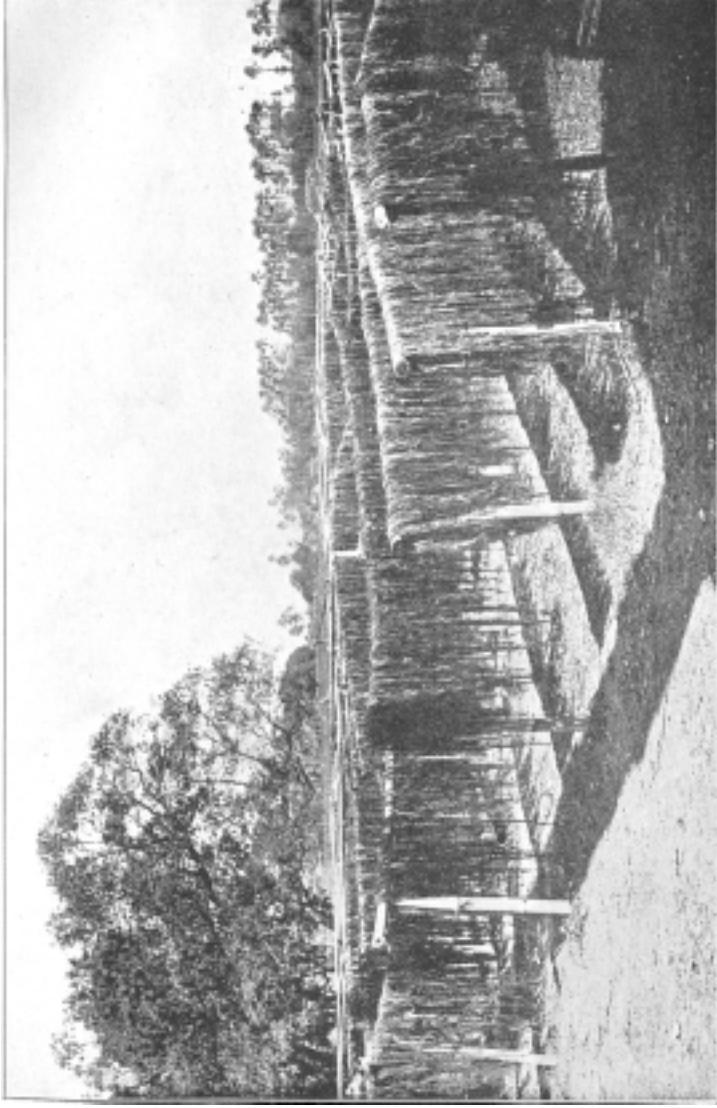

A FIELD OF DECORTICATED RAMIE DRYING.

in a district where the conditions of climate and soil are practically suitable for rhea, or ramie, and where such a yield of long stems would be obtained that the shorter ones could be neglected. Such conditions are not easy to be found, but," adds Mr. Finlow, "it is possible that some parts of Assam might realise them. As far as I am aware, the Faure machine has only been worked in Behar."

The Faure machines are of two kinds, one the ordinary machine used for scutching the butts of the stems, the other similar to the first, but with the addition of a counteraction to which the stems, after insertion into the machine, are attached by the scutched ends, and by which the fibre is automatically withdrawn and delivered. In practice it is found that one ordinary machine will scutch the butts of enough stems for two counteraction machines, so that it is found convenient to work the machines in triplets. In order to avoid damage by cutting in the latest Faure machine, instead of the fibre being drawn back in the process of scutching by the automatic counteraction, it is carried straight through a set of beaters which merely break and disintegrate the wood and bark, and it is then deposited on a carrying chain, where it is presently caught at one of the ends by a comb and fixed tight on this chain. In its progress the opposite ends are quietly dropped between the blades of a couple of drums of quick revolving beaters, and on the return journey of the chain are withdrawn. The action of these beaters is so adjusted as to cause a combined hitting and scraping motion, and is yet so regulated that the tension exerted on the fibre is not enough to break it. In this way the inventor hopes to save entirely the loss by cutting of the fibre by his original machine.

In the course of a letter respecting ramie decortication, M. Faure, the inventor of this machine, who is an experienced engineer, and whose firm at Limoges are makers of machines for the manufacture of porcelaine and faience, preparation of kaolin, and also for the treatment of sugar cane, in addition to ramie-decorticating machines, says that in India eight boys are able to

turn out every day 200lb. (100 kilogs) of ordinary fibre per ten hours with a set of machines costing about £160, and he adds that it is an easy matter to condemn his machine when it is worked on bad material. He takes exception to trifling defects in the same being made an excuse to cover planters' failures to grow the fibre in a proper manner, and contends that in those cases in which good stems are placed in the machine for decortication, it will perform this operation in the manner which it is claimed capable of being able to do, and with but slight waste either in regard to the long or short stems—with no waste, in fact, save such as is in accordance with commercial requirements, say about five per cent., which will fall through the hands of those tending the machines. He lays great stress upon the fact that proper cultivation of the plant is absolutely necessary if the machine is looked for to accomplish all that is desired, and thinks it unreasonable that it should bear the blame of careless or indifferent growth of the stems. No loss has been made in the working of the machines on the Limoges ramie crop which he grows, and he says it would be much more difficult to express derogatory opinions upon its performances if inspected at work upon a well-cultivated crop there than has been found possible upon badly tended plantations elsewhere. Yet the opinion that any machine is perfect is only ventured by those who do not understand the meaning of progress. Though not absolutely perfect, the machines are, he claims, very good, and he is acquainted, as the result of recent experiments, with the means of remedying any slight defects that exist in new machines which he may be asked to construct, introducing various improvements. He is, however, only desirous of giving effect to these innovations in cases where persons communicating with him are really anxious to purchase and make use of the machines, and prepared to devote the attention which is necessary to the growth of the plant and production of good workable stems. Accordingly it is only fair to this machine to bear these remarks well in mind in considering Mr. Finlow's remarks in regard to its

performances in Behar. It will be observed that the latter gentleman agrees with Sir George Watt in the opinion that Assam is the most suitable area for ramie culture, and that in which it will show a profit on cultivation. To this may be added the Shann States, the Duars, and Kangra. As to his remarks on what in ramie manufacture is the most important point in the matter to-day—namely, its decortication—it will be observed that he considers the Faure machine as it stands to-day a great advance on past efforts, and sees no reason why the ramie planters in areas where the climate and soil are really suitable should not find it to meet all practical requirements. Its use, while interposing no obstacle to their making a profit on growing sufficient to satisfy them, might be the means of supplying ramie spinners in Europe and America with an article equal to hand-cleaned China grass much cheaper than the rate or rates at which they now obtain the latter product, so opening at once innumerable large new markets of trade to the fibre in which the spinner and manufacturer would realise very substantial profits.

Green stems grown in a tropical or sub-tropical climate give the best results. The growth being quick, the stems carry plenty of fresh green juice, which assists the decortication very much by leaving the fibre freely, and carrying with it in its downward course from the beating point of the machine large quantities of extraneous matter. The condition of the stems at the time when they are treated also plays a very important part. To obtain the best possible fibre, the stems should be treated within a few hours after being cut. They should not be over-ripe, as the fibre deteriorates after the stems have arrived at maturity. The best method is to cut them either just as they are at full maturity or slightly before. The fibre so obtained excels in whiteness and ductility, retains its full lustre, and shows to the very best advantage during the after-manufacturing operations, such as preparing, combing, spinning, dyeing, etc.

The cost of extracting the fibre from the green stems,

drying and packing it into bales, amounts to about 3s. 9d. per ton of stems treated, or £3 15s. per ton of dry fibre obtained when working with ten machines and native labour at 1s. per day, including motive power, stores, etc. If the labour be calculated at 2s. per day, the cost will be 5s. 1½d. per ton of green stems, or £5 2s. 6d. per ton of dry fibre obtained, assuming that the stems give 5 per cent. of fibre. The cost of extraction is, of course, liable to be much affected by the price of labour, the cost of motive power, and by various local circumstances.

The No. 1 machine is known as type de démonstration; No. 2, type industriel; No. 3, type grand production. The quantity of dry fibre which the last machine will produce depends upon the length and size of the stems. When the stalks are exceptionally good the machine, which will decorticate five tons of green stalks in each day of ten hours, will produce 400 kilos. of dry fibre.

The crop yielded by 8 hectares (1 hectare equals 2.471 acres), cultivated at Limoges, after four cuttings, has been found to be 700 kilos. of dry fibre per hectare per crop. The climate is not very favourable for cultivation to show large yields.

In working No. 2 machine the speed pulley used requires to have a diameter of 250 millimetres, and must revolve at the rate of 550 revolutions per minute. Two pulleys should be used, the one loose and the other fixed, and a leather band by which the stems can be carried to the hands of the workman. A band of 65 to 70 millimetres width is sufficient. A sirocco fan for finally drying the fibre in wet and cloudy weather, and two hydro extractors for the preliminary drying of the fibre, can be made use of with advantage. Tanks should be erected at a high level to supply water under pressure to the machines for washing the fibre.

There is little doubt that before long, as the principle of the Faure machine is correct, the slight mechanical difficulties which present themselves will be overcome, and the machine made all that is desired.

There are also three other machines made for decorticating ramie. One of these is the German Aquielles; another is an English machine called the Andrewe. They produce an article like the Faure machine, but in the Andrewe there is substituted for the downward stroke of the beater blades in the Faure machine a gentle combing motion, which is said not to injure the fibre as much. The third machine is the Schlichten ramie decorticator, which has been invented by Mr. George Wm. Schlichten, of the Schlichten Ramie Co., 473, Broome Street, New York City, a concern which has taken many gold medals at American exhibitions for their ramie manufactures, especially their hygienic ramie hosiery and underwear, in which, together with knit goods, they do a large trade, and also in the production of pure ramie materials. This firm claim to produce a very superior ramie linen in the United States of America. Mr. Schlichten's first machine was given a preliminary trial at Los Angeles, California, in 1907, when, in spite of unfavourable circumstances, it gave very satisfactory results. Since then he has constructed a larger size machine, which worked successfully in the decortication of ramie in Southern California last fall, and Mr. H. Lyster Dewey, botanist in charge of fibre plants to the Bureau of Plant Industry, Washington, says that the successful operation of this machine may be said to be the most important step in recent years to the production of ramie fibre in America. A description of this, the latest machine, is therefore of interest. It is 12 feet long, including the feeding tubes, about 4 feet high, and $4\frac{1}{2}$ feet wide all over. The rollers and actual operating parts are $4\frac{1}{2}$ inches in width inside of the frame. It weighs $2\frac{1}{2}$ tons. The stalks are fed on an inclined feeding table. They first encounter two smooth rollers, followed by a third, which turns them downward through a reciprocating sash brake, vibrating horizontally. The brake is followed by a scutching cylinder, and then passes between two horizontal slat carriers, which travel at a rate of speed somewhat faster than the fibre, and thus have a scutching action on both the upper and lower surfaces of the layer of fibre.

F

The operator grasps the fibre by the end as it leaves the carrier, and by drawing it along prevents it becoming tangled. The fibre thus leaves the machine endwise, but can easily be kept free from tangles, and straight.

A 14h.p. engine will drive two machines. Five hundred pounds of dry stalks can be fed to the machine in forty minutes, producing 107½lb. of fibre, and Mr. Dewey states that with a little experience of the machine operatives can clean one ton of fibre per day. This is a large production.

The Schlichten Ramie Co. have taken amongst other gold medals two at Jamestown, in 1907, and the grand prize at the Louisiana Purchase Exposition.

CHAPTER V.

Method of Preparing Ramie Ribbons for the Market.

THE chief spinners of rhea, China grass, and ramie in Europe and in the United States state that up to the present time they have not had this product—namely, the fibre-yielding bark stripped from the stems of the plant and dried—offered to them in such a condition as to enable them to arrive at any decision as to what price or prices they can offer for the same. As stated already, ramie ribbons are almost certain ultimately to disappear completely from the market, China grass and machine-decorticated fibre, produced by such a machine as the Faure decorticator, taking their place. It is, however, pretty certain that if they are carefully cultivated, thoroughly dried, and not baled in anything like a damp condition, they will find a market at a profit to the grower, as there are several degumming processes working which will extract the fibres from them without damaging their strength and other good qualities. Up to to-day they have invariably reached the factory in a more or less dirty, and at times a damp, condition, which rendered their degumming in a proper manner exceedingly difficult, if not absolutely impossible. Persons who have the

plant growing, or purpose experimenting with it, will, by submitting samples of clean, well-dried ribbons, be able to ascertain what prices are offered for them, and what quantities might be consumed by spinners. In order that they shall be fit for use they must fulfil the last-named conditions, and the following method is recommended for their production. The bark should be split with a small sharp knife by the native, and by inserting his thumb and forefinger in the aperture so made, and running it along the stem, he can easily strip off the ribbon of fibre-yielding tissue. The strips, or ribbons, should be placed in baskets when so stripped, and then spread on wire netting, supported on uprights, in order to dry them, whether this is done outside, or in covered lofts or buildings. They should be thinly spread and turned over from time to time. By adopting this method the heat will reach them at all points, above and below, and the netting keeps clean. But before splitting the stems the native must wipe each down with a cloth; in this way the dust or dirt which may be on it will be removed. When the ribbons are placed on the ground to dry, they contract dirt from the soil, and the natives are apt to soil them by walking upon them when turning them over. They must be removed indoors at night to avoid the dews, and they should be taken from the netting to under cover in baskets, which should not be interfered with until they are carried out again to place their contents once more, in the morning, on the netting. When thoroughly dry they can be packed, and care must be taken in doing this that it is done in such a manner that damp cannot reach them from outside during their transport to manufacturing centres. If it does fermentation will set in and more or less rot the product, rendering it of greatly reduced or no value at all to the spinner when it reaches his mill.

When the stems are dried to be decorticated in this condition by machine they should be dealt with in exactly the same manner, save that they might be tied into bundles as cut of the same size or thereabouts, and the stems kept in this order when drying,

and afterwards in decorticating. The fibre obtained, if this is done, will be more uniform than if the long and short stems are mixed indiscriminately. The same practice should be adopted in decorticating freshly cut green ramie stems. Spinners like bales of ribbons to be 5cwt. to 10cwt. in size. Rhea, China grass, and ramie fibre are brought on the market, or imported into Continental Europe, by Hamburg and Antwerp produce brokers principally; in London Messrs. Ide & Christie, 72, Mark Lane, and Messrs. Hindley & Co., 63, Queen Street, are the chief firms importing for English requirements.

It is stated that fibre decorticated by the Faure machine is improved and rendered proof against fermentation setting in on the voyage by boiling for about 1 hour in water with 1 per cent. carbonate of soda added. This treatment for, say, $\frac{1}{2}$ hour to 1 hour might have the same good effect on the ribbons if given to them directly after they are dried. They would then have to go through this latter process a second time, of course, or the experiment of boiling them in the green state when stripped from the stems and before they are dried might be tried. They must be perfectly dry and clean, however, eventually to find a market, and the carrying out of this process should be supervised by European overseers or trustworthy natives on the plantation. Well-cultivated rhea ribbons invariably yield from 45 to 55 per cent. of workable fibre when degummed. The yield may vary a few per cent., but it is very rarely, if ever, less than 45 per cent. on the net weight treated. China grass gives 70 per cent. degummed filasse on net weight treated. If the product is prepared in the manner stated, it should produce a thoroughly satisfactory fibre if degummed by an efficient process, although hand-cleaned fibre, such as China grass or Faure-decorticated fibre, now largely monopolises the market, owing to the distrust created in the minds of spinners in regard to ribbons, by the repeated consignments which have been sent to Europe in past years being dirty, damp, and weak, or rotten in the strength of the fibre they contained as a natural consequence.

CHAPTER VI.

Degumming Ramie, or Rhea.

WHEN the bales of China grass or machine-decorticated fibre arrive at the factory in Europe or America (there are no ramie mills in India at the present time, so far as the writer is aware, although mills exist in China, and Japan), the first step in the process of manufacture which has to be carried out is that of degumming. "Ungumming" it is sometimes termed—the French speak of it as "dégommage." The bales are opened, and the product is sorted into lots according to the different qualities of length, colour, and freedom from outside substances.

Lots of similar quality are then packed in kiers, such as are used to bleach cotton, or vats, and the product is treated by steam, water, and chemical agents in such a manner that the gum is eliminated, leaving the fibre freed from skin, dirt, gum, and the chemical agents employed. To carry this process out successfully, plenty of pure water and steam, and plant and machines, which will deal with the product effectively, and yet at the same time at the minimum of cost, are requisite. The material should be handled as little as possible. Washing-machines, hydro extractors, squeezers, pumps, etc., are made use of in addition to kiers and vats. The fibre must in no wise be affected detrimentally by this process. Its great strength, softness, and lustre must remain the same after it has been carried out as before the treatment began, otherwise it loses its value. The fibre has naturally a beautiful lustre—nearly equal to that of silk, and quite equal to the lower qualities of silk. This lustre has to be retained, and the filasse must not be passed through any treatment which will cause it to become harsh or brittle, otherwise it will be difficult to prepare and spin, and fabrics woven from it will exhibit a tendency to split and crack on the surface, crease permanently, and cockle under rain. No drugs of a deleterious nature must be made use of, or the fibre when woven into piece-goods will, when sent

to undergo the process of bleaching, preparatory to being placed on the market in the white state, or dyed and printed, deteriorate in strength. When ramie is well degummed it takes dyes freely, especially all the finer dyes, and lends itself to the absorption of the brightest colours quite as successfully as silk. At the same time its fine silky lustre remains unchanged, so this affinity which it possesses for receiving colours, and its quality of retaining them, must not be damaged by the process of degumming, and not only must the treatment be of such a nature as will cause the fibre to lose none of its strength, lustre, and colour at the time when it is manufactured, but such as will enable these to be retained by it for years afterwards. The first essential to degumming successfully rests in the selection of suitable chemical agents in solutions of such strengths as shall not weaken the material. When the fibre has been degummed, it passes through the process of bleaching. No special plant is necessary, and it may be bleached in the same manner as cotton or flax. Opinions differ as to the extent of chemical bleaching which should be given to ramie. Some manufacturers make a practice of completing the bleaching directly the ribbons or machine or hand decorticated fibre are degummed. Others prefer to half bleach this filasse, and complete the bleaching upon the grass in an identical manner to that in which linen goods are bleached. Others leave the bleaching process to a later stage—namely, when the filasse has been spun into yarn and woven into cloth. No bleaching whatever is necessary for many descriptions of goods, which, as a rule, are sold and made use of in the grey state—for example, many kinds of linings, canvas, sail cloth, etc.; also ropes, cords, lines, twine, etc. The fibre should be well washed and kept thoroughly clean for preparing and spinning operations afterwards.

When ramie is not only decorticated on the lands where it is grown, but degummed also by the aid of cheap native labour, such estates should be regularly laid out in beds or small fields, intersected by paths and roadways for vehicles, and the decortivating and

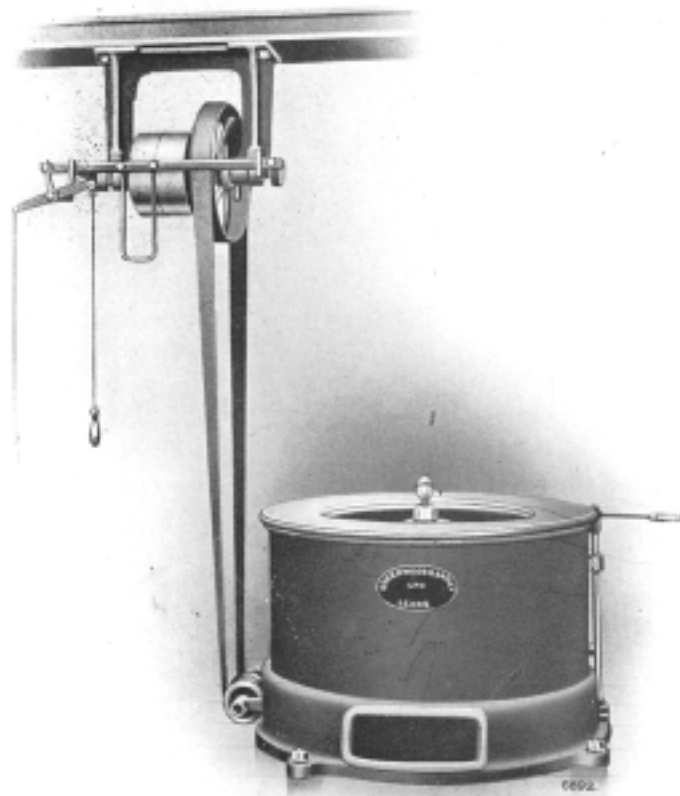

HYDRO-EXTRACTOR FOR RAMIE FIBRE.

degumming stations should be situated at one end of the plantation. The natives as they cut the stems and fill their baskets should take these to a central roadway running through the estate, along which a light tramway system should be worked. The baskets can then be deposited as they are brought down by hand or cart on the tramcar, which will be a quick and easy way of conveying them to the stations mentioned above for treatment. Stems freshly cut will decorticate and degum easily and cheaply, and with less risk of damage to the strength of the fibre than when this latter process is carried out in manufacturing centres. It has been estimated by those who have grown the fibre in the East, and studied it closely, that under this system of culture and treatment it could be produced, after a plantation had been established for some three or four years, at a price little more than what jute sells for to-day. In such districts as Assam the author considers that this is highly probable, but should it be raised by any parties at this figure in the future, it is not likely that they will sell it at the same price as the common jute fibre. Its known good qualities are sufficiently pronounced to prevent it ever being offered at such prices. It may be added that the opening up of rubber culture in the Shann States of Burma should create areas upon which ramie could be well and cheaply grown, the district being, as already stated, very suitable—in fact, it and Assam should be ideal districts, railway facilities in the former are good, and in the latter have of late improved considerably.

Speaking generally in regard to degumming, the processes made use of in this operation are kept jealously secret by all established and successful ramie spinners and manufacturers. The fibres may be degummed by washing them in running streams, or indeed by the Indian native manner already described. In some filatures machinery is employed, which permits of its being dealt with in degumming and bleaching in the form of a continuous rope, in the same manner that cotton is bleached, the fibre being conveyed through porcelain rings or poteyes to the kiers in which it is

treated. As to the exact methods to be adopted to extract the fibres so as not to damage their natural strength, lustre, and other good qualities, and secure the whole of the fibre contained in the ribbons, machine-decorticated or hand-cleaned fibre, under treatment, economically, no details which can be relied upon are known generally. It is usually effected, however, by the use of alkali and acid solutions, and other special drugs are employed to give effect to the general process at vital stages in its working. These have been kept secret by their discoverers. What concerns the spinner is principally to see that if he purchases the degummed filasse in the form of the sliver from the degummer it is cheap enough for the purpose for which he desires to use it, and guaranteed by the producer not to deteriorate in strength in any of the processes of spinning or weaving, or when sold to the consumer, and exactly the same may be said in regard to the manufacturer who purchases the yarns to weave alone, or mixed with other fibres or silk. One perfect degumming plant can naturally keep a good many spinners and manufacturers busy.

An American chemist, of Providence, Rhode Island, has recently invented a system of rhea, China grass, and ramie fibre assay by the use of which the spinner who purchases the degummed filasse to prepare and spin, or the degummed fibre in the form of the sliver to spin on the spinning frames; the manufacturer who buys ramie yarns to weave alone, or mixed with other vegetable fibres or silk; and the merchant who purchases ramie fabrics,—can, in an easy and cheap manner, test the efficiency of the degumming process which has been employed to treat the raw product from which any of these materials have been produced, and ascertain definitely whether or not the same is thoroughly strong, and especially whether or not the fibre will retain its proper strength after bleaching, preparatory to being placed on the market in the white state, if he purchases it for a purpose which will entail its being bleached when manufactured. Further, whether or not it will deteriorate in strength un-

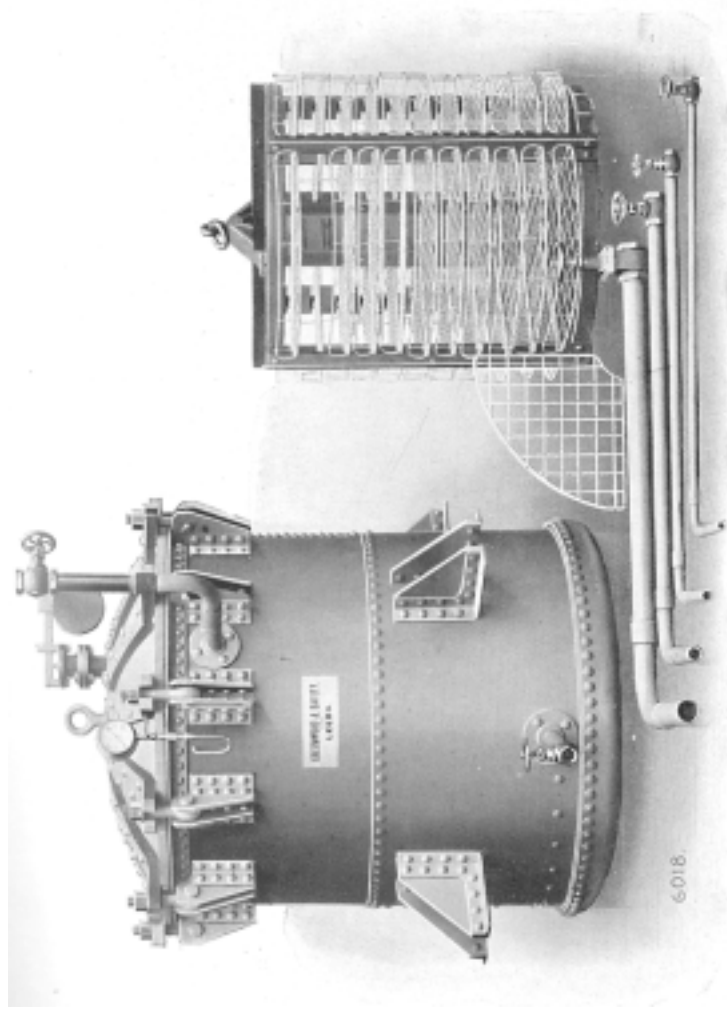

BOILING KEIR FOR DEGUMMING RAMIE FIBRE.

duly when submitted to washings, and wear, crease permanently when folded, cockle under rain, shrink, fail to take the dye satisfactorily, or prove defective in any other manner. This will effectually do away with the risk of loss arising to dealers in the material by reason of their purchasing fibre which has been degummed in a faulty manner, a great desideratum. The method is as simple as it has been proved to be cheap, easy, and effective.

CHAPTER VII.

Preparing and Combing Rhea, or Ramie.

WHEN rhea, or ramie, has been degummed, before passing the filasse on to further processes, it is prepared in a special manner which renders it more elastic, and more capable of passing freely through all the machines which are subsequently made use of in its manufacture. All these can be run then at their maximum speed, with the view of obtaining the largest possible production, and at the same time with the minimum of waste. When the fibre is rightly prepared, it very considerably facilitates its passage at full speed through all the subsequent machines, and so reduces the amount of waste produced to the very minimum.

If the filasse is treated in a thoroughly practical manner in the initial stage, all following processes are so facilitated as to make the spinning of ramie a commercial success. Good preparation at this period and good combing afterwards are the two most important operations in the manufacture of the fibre.

After being dealt with in the way of degumming and preparing, the fibre, or, as it is then called, "degummed filasse," still in stricks, is fed by hand into a gill-spreading machine, the object of which is to transform it into slivers, which are then passed through a series of other gill machines, and the slivers during their passage through the various machines in their proper order are opened out, simultaneously levelled, combined, and made of equal thickness and length, and so rendered capable of being effectually treated by the combing machines with the least possible waste.

These slivers are then fed in an automatic manner into the combing machines, and the fibres are combed automatically, separated into their different qualities, and delivered by the machines into cans in the form of slivers, which then undergo the further processes of doubling, drawing, and equalising. If the spinning machines are to produce good, clean, and level yarn, no combing machine but one of the most modern kind must be made use of. The leaving of a large amount of short fibre, or noil, and matter of an outside character in the finished sliver of long fibre, or top, will so be avoided, and the yarn obtained will be of the description above referred to. A defective combing machine will be found to injure the fibre during its combing by breaking and shortening it, which reduces its quality and value, and adds to the amount of waste. This is a point to which the spinner, if he is going to succeed in working profitably, must give especial care. There are some combing machines which possess these defects only to a very limited extent, but which, on the other hand, have only a small production, and the labour necessary is high in wages. These, in the same manner, cannot be made use of commercially.

The following must be the salient points in any machine selected by the spinner for carrying out this process :—

It must be constructed in such a manner that it will comb and separate the fibres into their different qualities, and deliver each quality separate. The fibres must not be broken or shortened during the combing.

It must effectually clean and free the fibre from all dirt and short fibre, or noil.

It should give a production of at least 300lb. a day and be capable of producing from properly prepared filasse about 70 of good quality long spinning fibre, or top, and 30 per cent. of short fibre or noil.

Skilled labour should not be necessary to attend it, and it should not be liable to break down, or get out of proper working order. Stoppage of combing machinery greatly lessens a mill's production, and necessitates very expensive mechanical labour to put the machines right again.

CHAPTER VIII.

Drawing, Roving, and Spinning Ramie and China Grass, Twisting, Etc.

THE drawing of the fibres is carried out by passing the combed slivers through a series of gill-drawing frames running at very considerable speeds. This gives the largest possible production. The relative sizes of the slivers, and the relative number of them fed into and combined in each of the drawing machines, must be proportioned in such a way as to make each machine deliver a sliver or tape as level as can be for the next machine. This is necessary in connection with every machine in the drawing frame. Great care beforehand must be given to the drawing process, as tape which is not regular will produce irregular rovings, and the yarn produced will be irregular and of depreciated value. The yarns obtained must be smooth, even, round, and, as a rule, as hairless as possible.

After leaving the drawing frames the slivers or tapes are then transferred to the roving frames, by which they are converted into rovings. The best roving and spinning frames for ramie are different in some of their principal features from the ordinary roving and spinning machines used for cotton, flax, worsted, and waste silk. Some of the most up-to-date motions of the machines used for these fibres and silk are embraced in their design, such as quick-running spindles, in order to secure a large production of the best work, and to overcome the difficulties formerly experienced in roving and spinning China grass and ramie.

A slight defect which is natural is met with in some qualities of ramie. This defect is what are well known in the trade as "hard ends," being, as a rule, fibres which have not developed to their full length, but have grown to some extent thick and short—in some instances, two or three fibres that have grown together. In a good combing process these hard ends are almost altogether removed from the slivers, but it is well in the best

descriptions of rhea, or ramie, yarns that they should be completely got rid of, or else the yarns are subject to inequalities. Woven and other materials manufactured from such yarns have a speckled look after having been dyed, and experts in dyeing state that these hard ends take up more colour than the rest and have no lustre.

To get over this difficulty, the slivers which are to be used for the best quality yarns should be passed through a second combing operation, and after, through a set of drawing or regilling machines. This frees them from all hard ends, and renders them fit for spinning into the finest descriptions of yarns suitable for the best classes of goods which it may be desired by the manufacturer to produce.

Many descriptions of fabrics are now being woven from ramie which it was thought a little time ago could not be produced. This is due to the improvements which have been made in the system of dealing with the assorted slivers after combing, to which reference has been previously made. Each quality of fibre is now passed separately through a set of drawing, roving, and spinning machines designed and made for that special quality, so that the fibre can be spun at the present time into the very best yarns of which each quality is capable, proper regard being given to strength, lustre, uniformity of size, twist, and speed of production. The spinning machines are so enabled to produce a wide range of counts of yarn in different classes of fibre, each description being adapted in quality and price for various qualities of goods, coarse, medium, and fine.

The noils, or short fibre, kept apart from the other qualities by the combing machine can be spun into good serviceable yarn, on ordinary tow machinery, being strong and regular. Cotton machinery will also spin them satisfactorily, and being strong, silky, and taking dye well they can be largely used. They make a good cloth woven alone, and give strength and lustre to the goods when woven mixed with other yarns, such as cotton, flax, wool, and silk.

Ramie yarns are largely used in the doubled state, and the twisting is, as a rule, carried out on flyer and ring twisting frames. Certain modifications are, however, introduced and additions made, which result in good work and large production being obtained. The same may be said in regard to the machines used for winding, gassing, reeling, and bundling.

Speaking generally with reference to preparing, combing, and spinning rhea, China grass, and ramie, it may be remarked that while the fibres can be spun well on flax, worsted, silk, or silk waste machinery, the best results are obtained upon a combination of machines made use of in all these trades. In the method above referred to, many of the machines are of special construction, and adapted with the object of thoroughly suiting the peculiar characteristics of the fibres, and would not accordingly be met with in any of these trades. On cotton machinery ramie cannot be said to spin very well. The machinery in cotton mills travels too fast to spin the fibres. This can be accomplished, however, if the drawing rollers are placed farther apart.

The machinery in existing flax, worsted, silk, and silk waste mills can, provided it is modern, be adapted to spin ramie and China grass in a satisfactory manner, and the alterations are not of a costly character, but old machinery should never be so altered. Any expenditure of money in this last-named manner is likely to prove a loss ultimately, as has proved to be the case in instances within the author's knowledge. On the wet line flax-spinning system good results can be obtained.

Different systems are made use of to describe the fineness, or counts, of ramie yarns. Some spinners of the fibre use the worsted scale, others the flax, others the silk, and again cotton counts are utilised. The fibre has been largely spun on the silk scale, but as it bears a nearer resemblance, and has a more intimate relationship to flax than to any other fibre, the flax scale is most extensively employed in describing the counts of ramie and China grass yarns, and it is one which is simple and easily understood by persons who do not possess a

technical education. Ramie yarns are accordingly divided into leas, or hanks, each of which contains 300 yards, and the number of hanks per pound implies the size of the yarn. So No. 60 ramie yarn contains 60 hanks, each containing 300 yards, equalling 18,000 yards to the pound.

The cost of spinning ramie is the same as the cost of spinning flax, and as it is a lighter fibre than flax it can be spun to a greater yardage—that is, about three-fifths more yarn can be spun from a given weight of ramie than from the same weight of flax,—and female labour can be largely made use of in most of the processes of the fibre's manufacture.

The remarkable length of filament which the fibre possesses makes it possible to spin it into very fine yarns with the minimum of twist, and so preserve its lustre to the fullest degree. Ramie is a bast fibre. Its separate filaments, however, are not congenial to each other, as they partake largely of the nature of hairs, so they have no natural tendency to adhere or cling one to the other—on the contrary, each is more inclined to go its own way. These peculiarities have to be considered and provided for in the formation of the slivers, rovings, and yarn. No undue amount of waste is made in spinning the fibre on any good system of machinery.

It is found advantageous in the roving of ramie for wet spinning to make the same with a very low twist. As the fibres when wet adhere very strongly to each other, rove prepared dry in the usual way with the ordinary twist cannot be drawn satisfactorily in the wet-spinning frame without breaking the staple, and if the twist is removed to the necessary amount in the dry rove it will not hold together and cannot be worked. In some mills it is therefore the practice to manufacture the rove itself wet, thus supplying the density lost by the necessary deficiency of twist. The loose slivers delivered by the rollers of the roving frame cannot be drawn through water without displacing the fibres and without the constant formation of laps on the drawing rollers, so a special apparatus

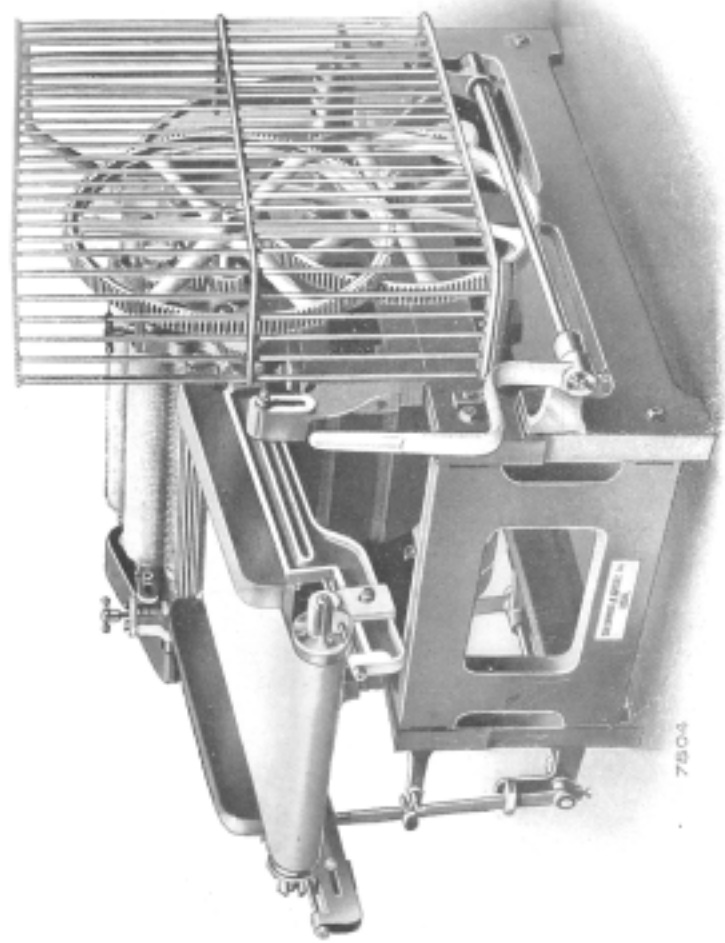

LARGE FILLING ENGINE FOR RAMIE.

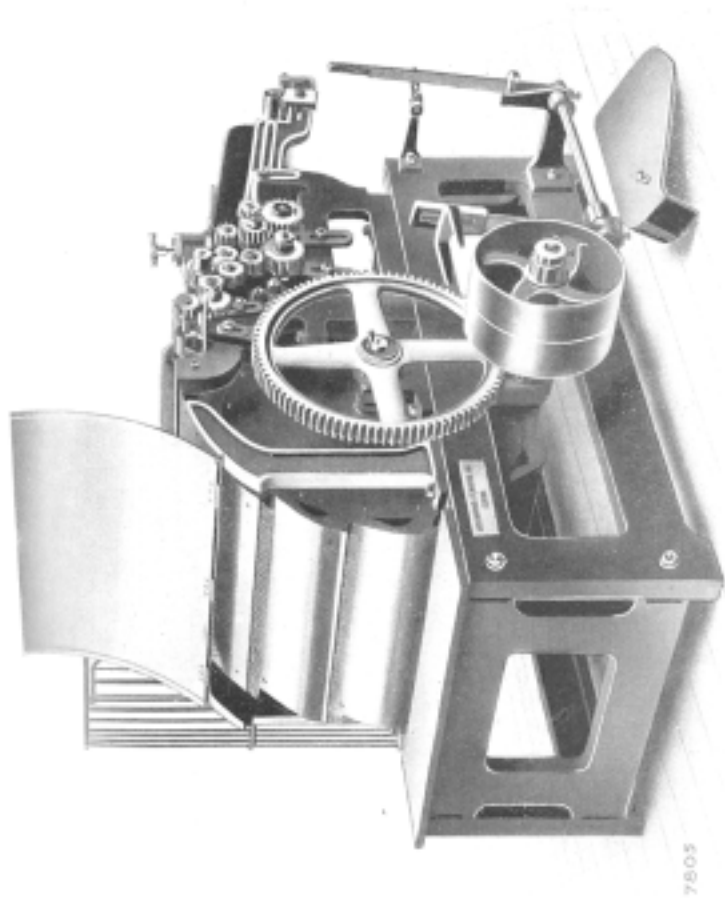

LARGE FILLING ENGINE FOR RAMIE.

is interposed between the delivery rollers and bobbins to wet the rove, and at the same time keep it smooth.

Upon one system of spinning ramie and China grass, which is employed in many of the most profitable Continental mills, and also in the East, and which the author considers one of proved merit, about 45 to 50 per cent. of first drafts are produced, and of a second, or rather shorter length of fibre, about 45 per cent. The percentage of loss from dressing, preparing, to spinning, from the degummed filasse and filling engine to the spinning frame, is about 20 per cent., of which a certain amount is returned in noil. The first drafts are dressed on a flat dressing frame, and so require no combing machines, only the short fibre from the drum of the flat dressing being combed after the fibre has passed through the filling engine.

In this system the latter plays an important part in the early preparing of ramie and China grass. The degummed filasse, which, after it has been treated in the kiers in this process, is to some extent felted, matted, and tangled, is placed upon the sheet of the engine, which conveys it to a pair of fluted rollers, by which it is delivered to five rollers having teeth, which, taking hold of the fibres, draw them out parallel, the combs of the cylinder of this machine carrying them gradually away. They are straightened still further by the action of a worker, and this and the five rollers are kept clean by revolving brushes. The latter are stripped by the cylinder. No stripping apparatus is fixed to the cylinder, and so the fibres accumulate upon it, encircling it completely when it is brought to a standstill for stripping by hand. The cylinder is covered with heavy wooden, or iron lags, which are chamfered off, leaving recesses, in the edges of which strong teeth are fixed. When the workman desires to strip the cylinder, he takes a pair of shears and cuts straight across the face of the cylinder, doing this at each recess, and in this way dividing its fibrous surrounding into sheets of fibre about 8 inches long. The filling engine has, as a rule, 18 combs upon its cylinder, about $44\frac{1}{2}$ in. diameter over the points of the pins and lattice feed sheet.

The flat dressing frames for ramie and China grass are made with self-acting stripping drum for dressing or working with clean combs. They have, as a rule, about thirty combs, webbing, filleting, sliders, and two sets of boots. The narrow sheets of fibre which have been cut from across the lap formed upon the cylinder of the filling engine are placed in the wooden books, or holders, of the machine above named, and a number of these books being tightened to each other in an oblong frame, the ends of the fibre projecting, the book frames are placed upon a carriage and run under a combing sheet which is spread between, and runs around two pulleys at either end of the machine. The book frame is next lifted from its carriage and brought near to the combing sheet by the aid of cams. When one end of the fibre has been combed in this manner it is reversed in the books, and the other end submitted to the combing sheet in the same way. The dressing machine can be stripped and kept clean by a toothed doffer stripped by a pair of fluted drawing-off rollers, which will turn out the noil or waste in a sheet.

The dressed fibre then passes to the screw gill spreader, which is generally on the intersecting principle, with 8in. of fallers up, $2\frac{1}{2}$ per inch screws, with retaining rollers behind the fallers, and three-foot drum.

"Faller" is a technical term used for a number of actual combs in the machine. Open screw gill boxes with $7\frac{1}{4}$ in. of fallers and 4 per inch screws, having retaining rollers behind the fallers and a three-foot drum, are also at times employed. This machine is sometimes termed a lap frame. These spreaders, or boxes, further comb and straighten out the fibres, which in this condition are transferred to an intersecting sett frame, which has two heads on one beam. Each of these is driven separately. There are 8in. of fallers up, $2\frac{1}{2}$ per inch screws, twin front rollers, and leather, or indiarubber pressings. The fibre is on this machine converted into what are termed "slivers," and these are then placed on the drawing frames.

The function of the drawing frame is to attenuate or draw out the combed sliver, and render it more and

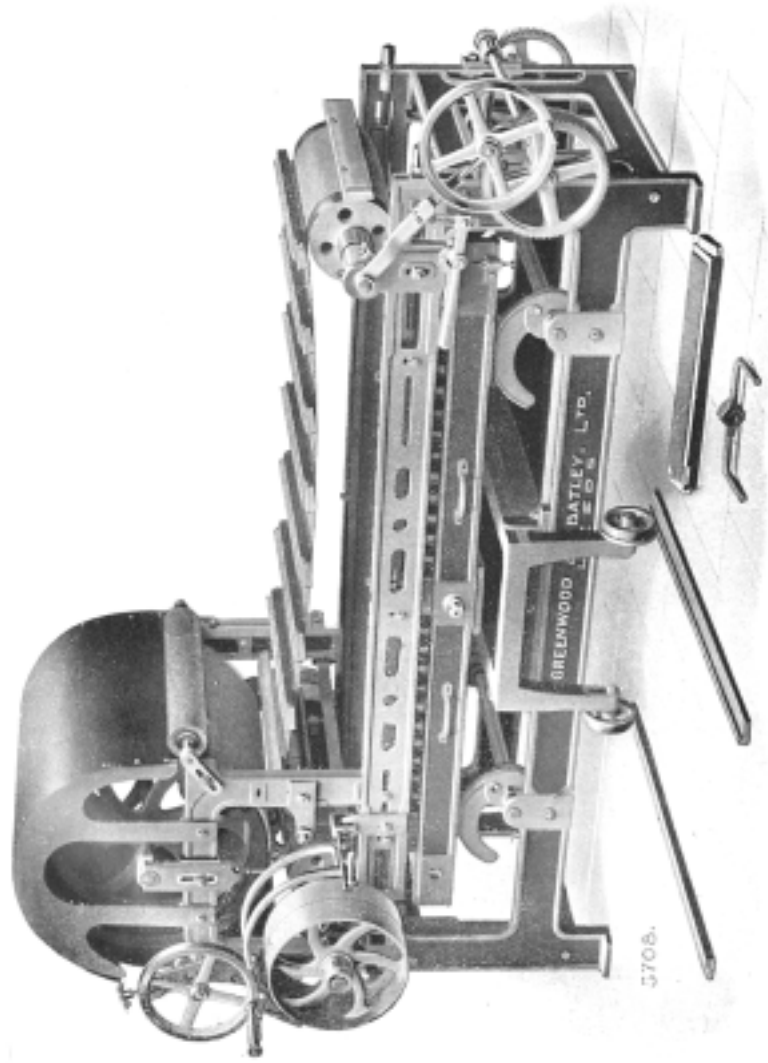

PATENT FLAT DRESSING FRAME FOR RAMIE, WITH SELF-ACTING STRIPPING DRUM

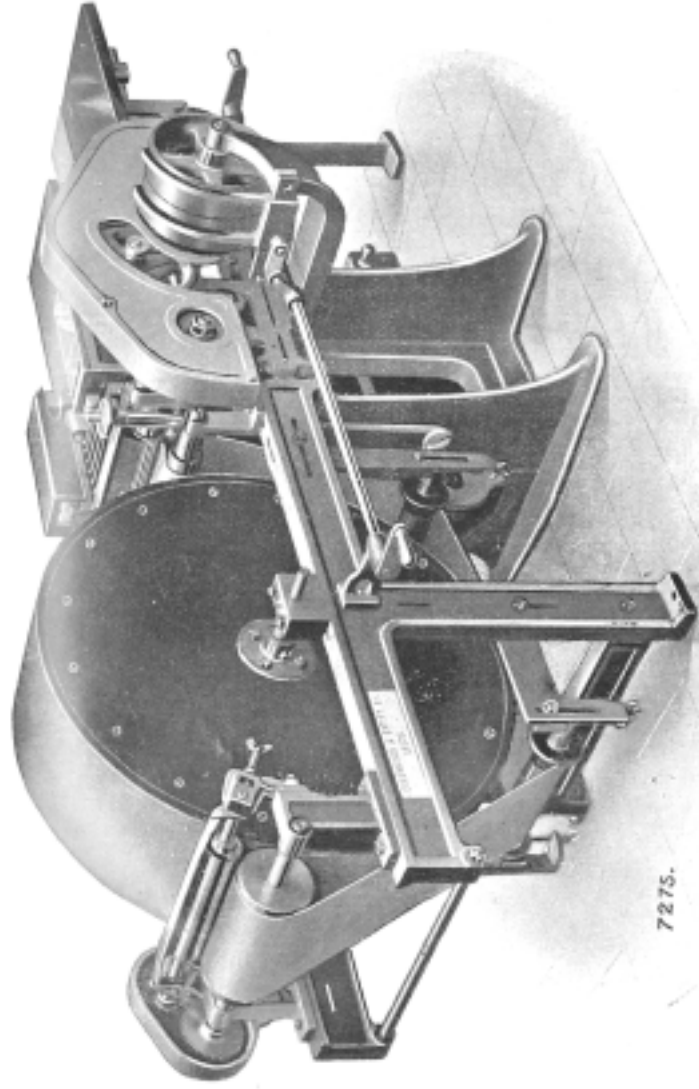

7275.

PATENT INTERSECTING SCREW GILL SPREADER FOR RAMIE.

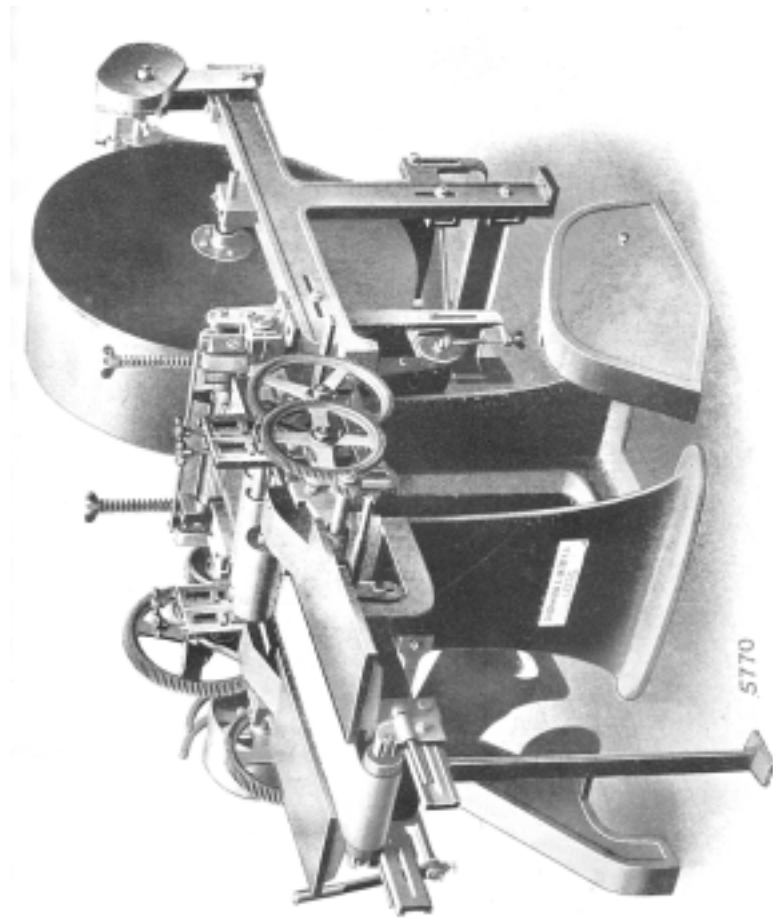

PATENT OPEN OR SINGLE SCREW GILL SPREADER FOR RAMIE.

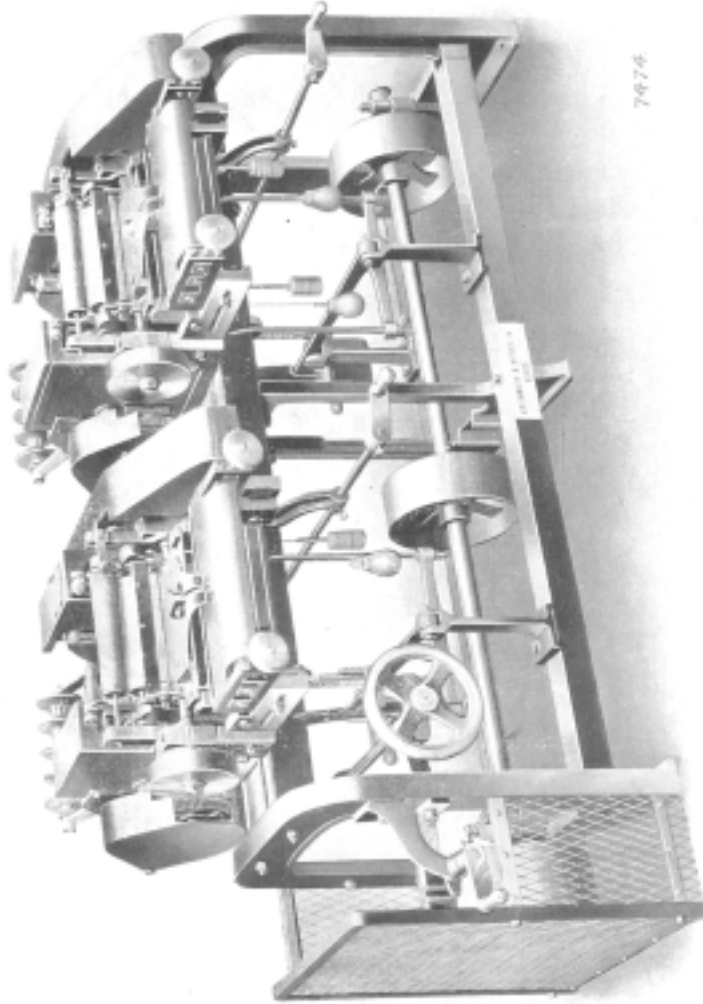

PATENT INTERSECTING "SETT" FRAME OF TWO HEADS ON A BEAM FOR RAMIE, AND EACH
DRIVEN SEPARATELY.

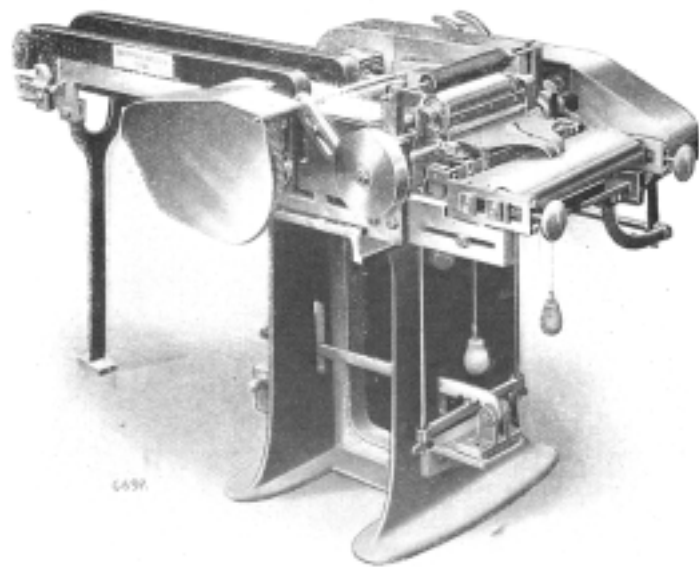

PATENT OPEN OR SINGLE SCREW GILL "SETT" FRAME FOR RAMIE.

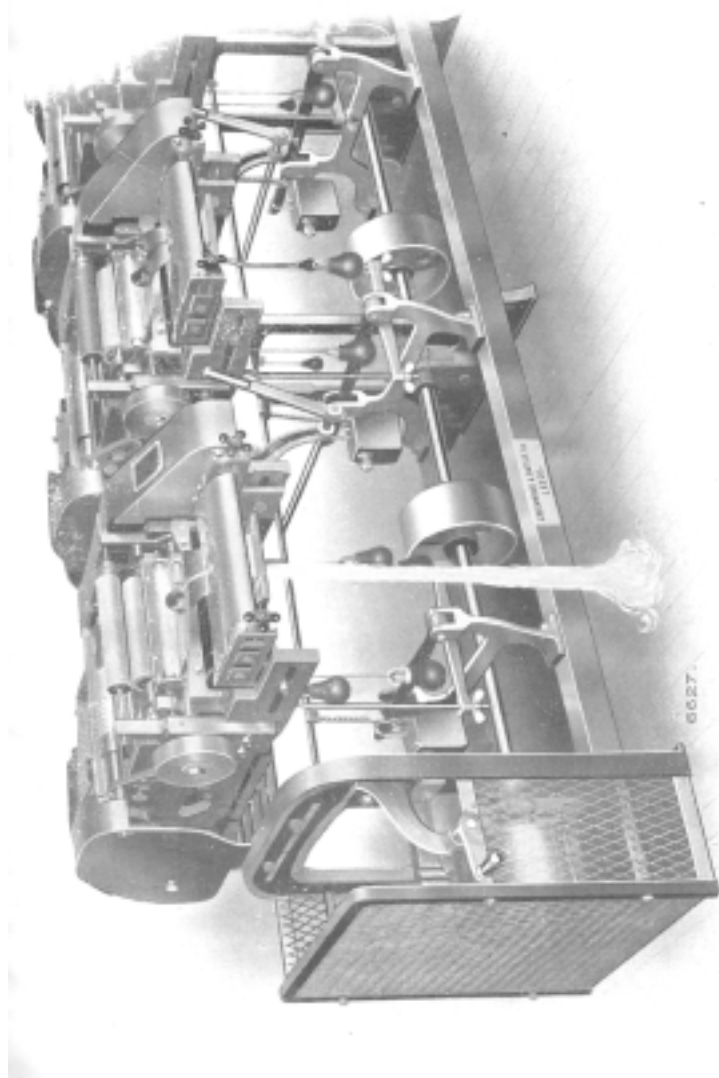

PATENT OPEN OR SINGLE SCREW GILL DRAWING FRAME OF FOUR HEADS ALL ON ONE BEAM, AND EACH DRIVEN SEPARATELY FOR RAMIE.

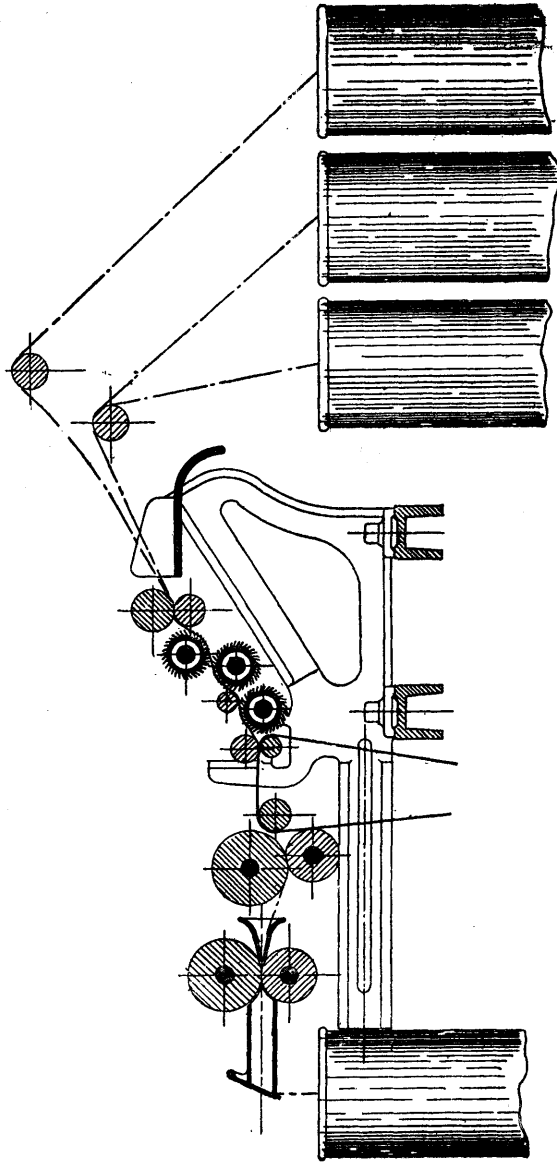

ROTARY GILL DRAWING FRAME FOR RAMIÉ, WITH FOUR HEADS.

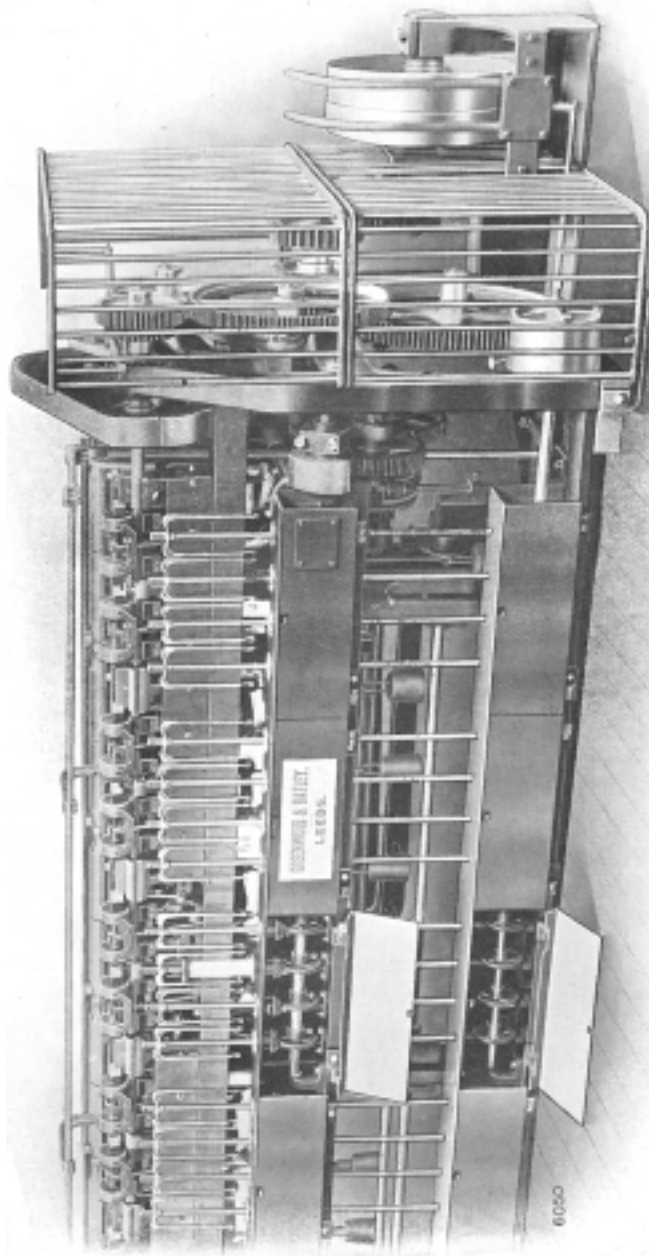

PATENT SCREW GILL ROVING FRAME FOR RAMIE.

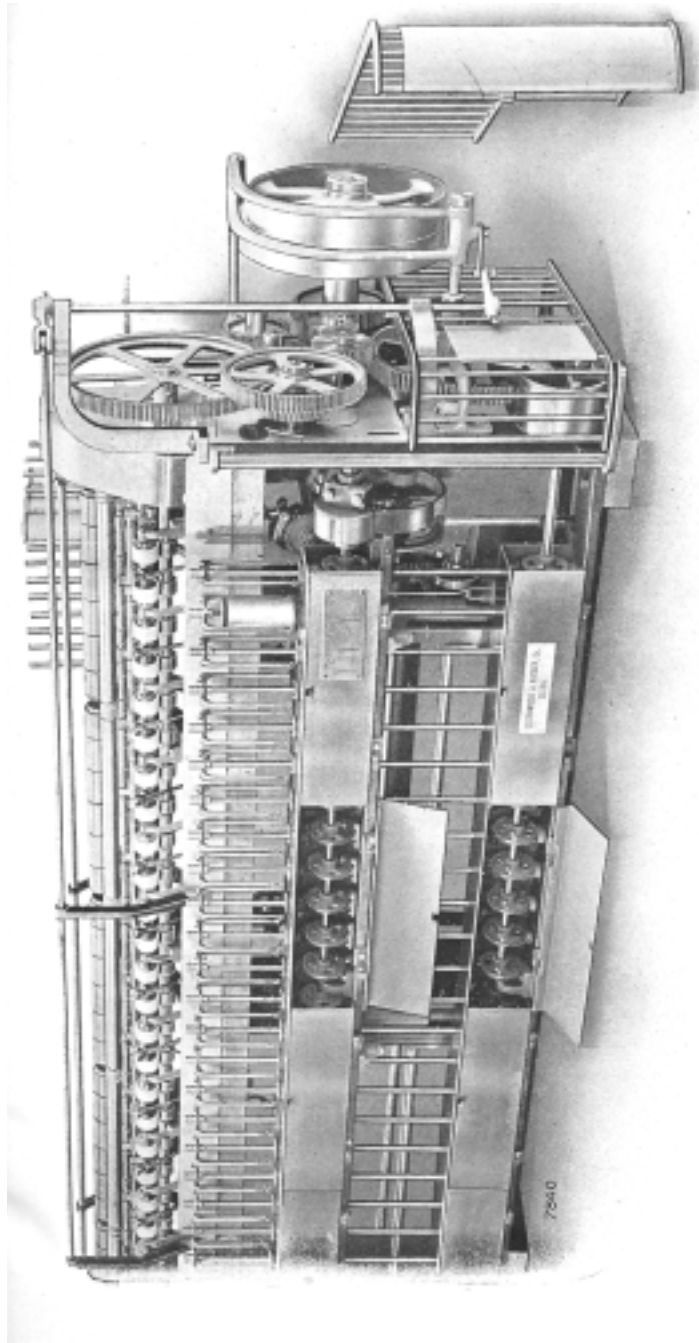

DOUBLING ROVING FRAME FOR RAMIE.

7540

more uniform, until it is in a fit condition for twisting. Rollers revolving in the machine at different speeds draw out the sliver, a certain number of slivers being here welded into one finer than either.

The drawing frames for ramie and China grass are, as a rule, open or single screw gill drawing frames, with four heads all on one beam, each driven separately, about $9\frac{1}{2}$ in. of fallers up, 4 per inch screws, $1\frac{1}{2}$ in. diameter of screws, with conductors behind for some twelve slivers, twin front rollers, and leather or india-rubber pressings. Rotary gill frames, with the same number of heads in one beam, each driven separately, having three rollers fitted with teeth, conductors behind for the same number of slivers as the single screw frames, twin front rollers, and leather or indiarubber pressings, and one line of delivery rollers, are also brought into requisition in the drawing operations where certain results are desired.

The slivers of ramie having been drawn or elongated to the degree wished for are now transferred to the roving frames.

The roving process may be defined as a combination of drawing and twisting, with an excess of drawing, while spinning is a combination of the same processes with an excess of twisting, and at this stage the first twist is put in the sliver. The screw gill roving frame employed will have about 40 spindles. Some frames are made with 24, and dandy roving frames with 100 spindles have been used. They have a double cone regulating motion, single row of spindles, 4 spindles per head for 6 in. by 3 in. bobbins, about 7 in. of fallers up, 5 per inch screws, 1 in. diameter of front roller, and front pressings covered with indiarubber. Doubling roving frames are also made use of, having, as a rule, about 60 spindles, with double cone regulating motion, single row of spindles, 6 spindles per head, about 4 in pitch for 6 in. by 3 in. bobbins, front roller bosses 2 in. diameter, and front pressings covered with leather or indiarubber. There are three lines of carrying rollers in these machines with wood carriers, and two lines of rear rollers with single pressings. Rotary

roving frames of about 40 spindles, with the same regulating motion, single row of spindles, 6 spindles per head, the same pitch for the same bobbins, front roller 1in. diameter, and front pressings covered with leather or indiarubber, are at times employed for roving purposes.

The ramie or China grass rovings are now carried to the spinning frames. The wet ring spinning frame generally used, has some 300 spindles, with $2\frac{1}{4}$ in. pitch of spindles, 6in. traverse, the spindles are self-contained and driven by bands, single cylinder, reach up to 12in., brass front roller $2\frac{1}{2}$ in. diameter, fluted boxwood pressings, two lines of brass carrying rollers 1in. diameter, and brass back roller $1\frac{1}{2}$ in. diameter.

The dry ring twisting frame used by many ramie spinners has some 272 spindles, with 3in. pitch of spindle, 6in. traverse, the spindles are self-contained, driven by bands, have a single cylinder, iron front roller diameter 3in., and cast-iron pressings. Wet flier twisting frames of varying number of spindles, 3in. pitch of spindles by 3in. traverse, self-contained spindles, four spindles driven by one tape, tension pulley, with single cylinder, 3in. diameter brass front roller, and pressings covered with brass, are also to be met with in numerous ramie mills where they meet special requirements.

It will be evident that in such an industry as ramie manufacture a certain amount of experimental spinning must be done to pave the way for the successful production of specific yarns for particular purposes. Experimental spinning and twisting frames for ramie, having some 20 spindles spinning on one side and 20 spindles twisting on the other, which occupy only 10ft. by 5ft. of space, are made by one English firm of machinists for wet and dry spinning, and on these ramie rovings can be spun and twisted by any spinner, easily and cheaply, into a great variety of yarns with the object of testing any particular market which he may consider offers the prospect of profitable business.

The cleaning, gassing, reeling, and bundling of the fibre are processes to which careful attention must be given if the yarns are to render satisfaction on the

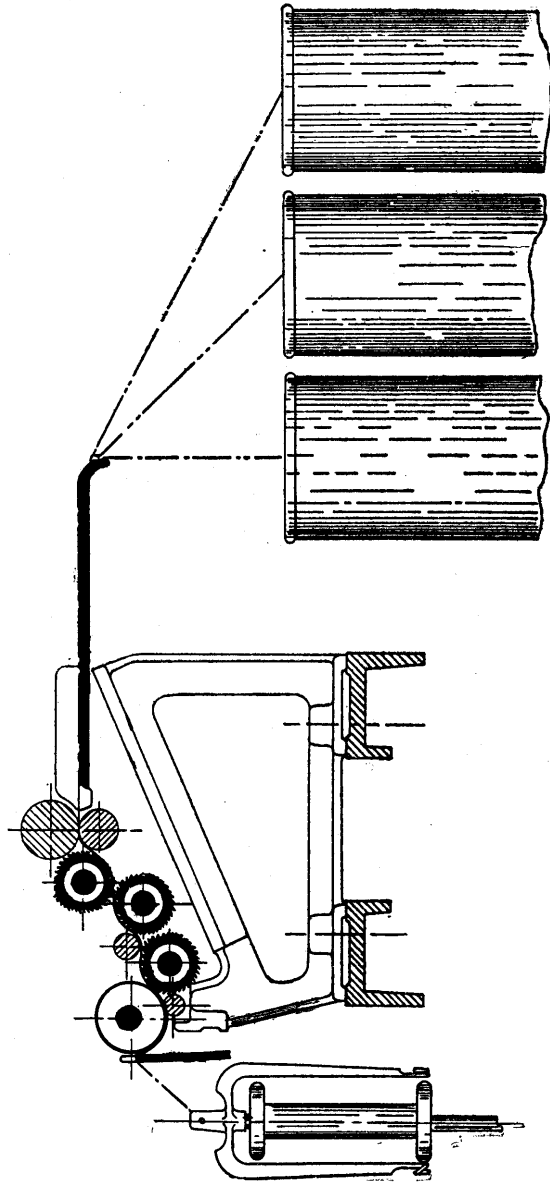

ROTARY GILL ROVING FRAME FOR RAMIE, WITH FOUR HEADS.

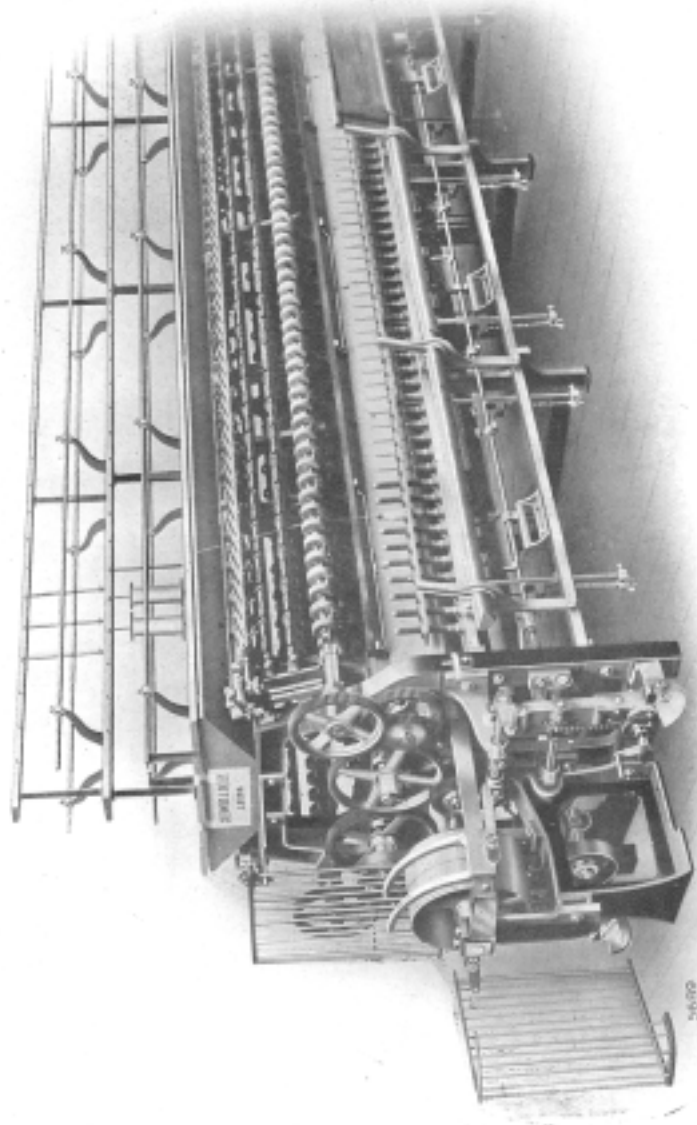

WET RING SPINNING FRAME FOR RAMIE.

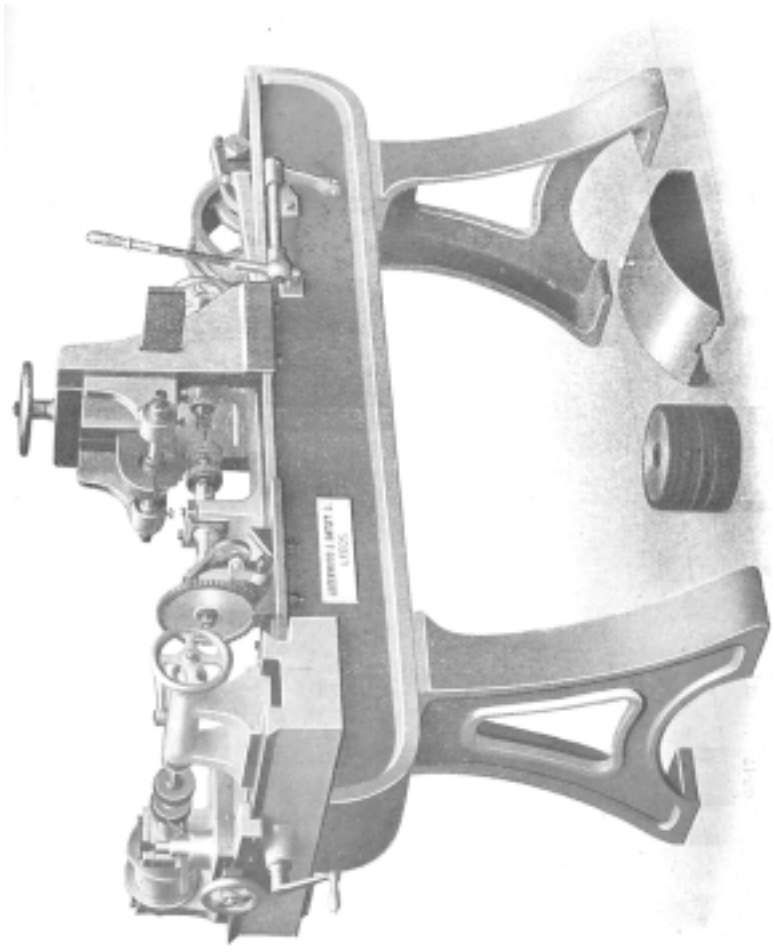

TURNING AND FLUTTING MACHINE FOR BOXWOOD PRESSING ROLLERS FOR WET
RAMIE SPINNING FRAME.

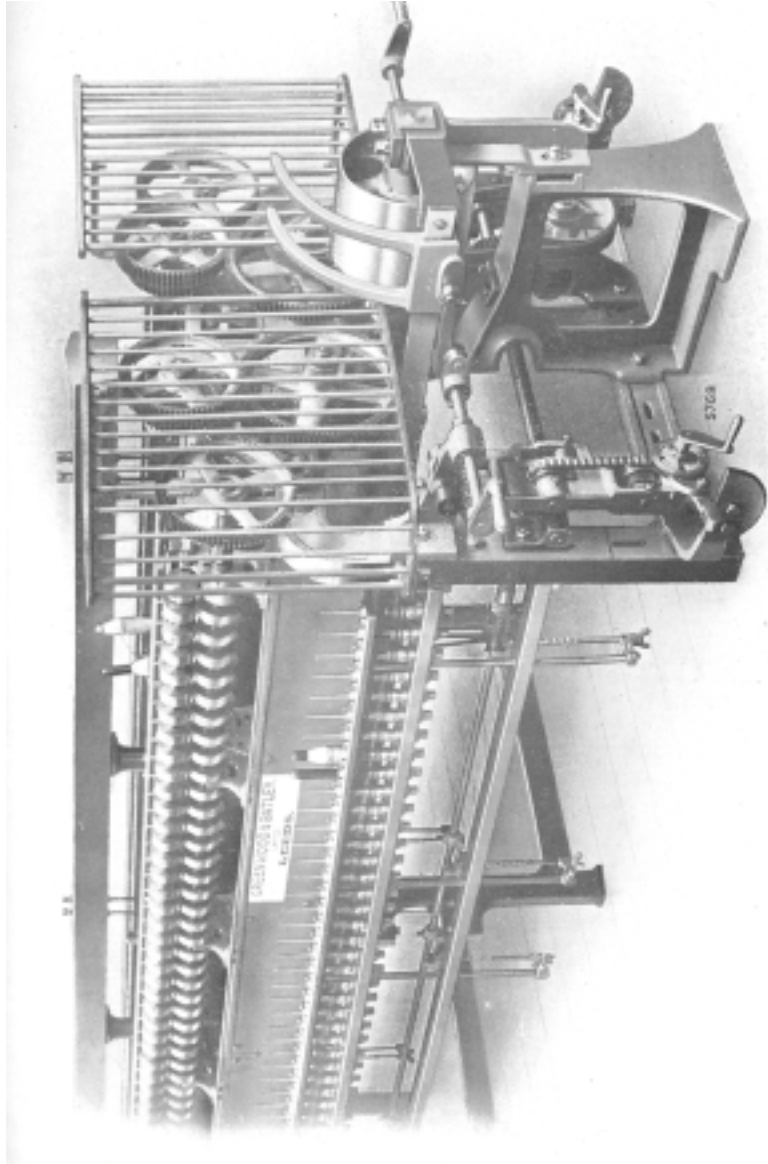

NEW YORK MUNSELL BROTHERS' PATENT TYPEWRITER

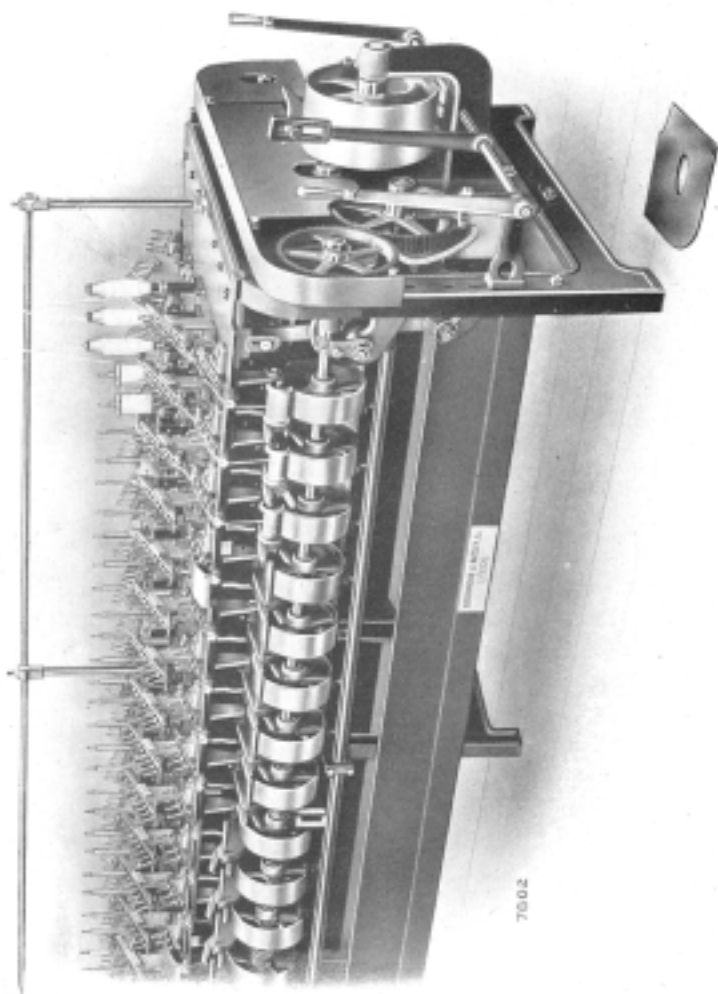

CLEANING AND GASSING FRAME FOR RAMIE.

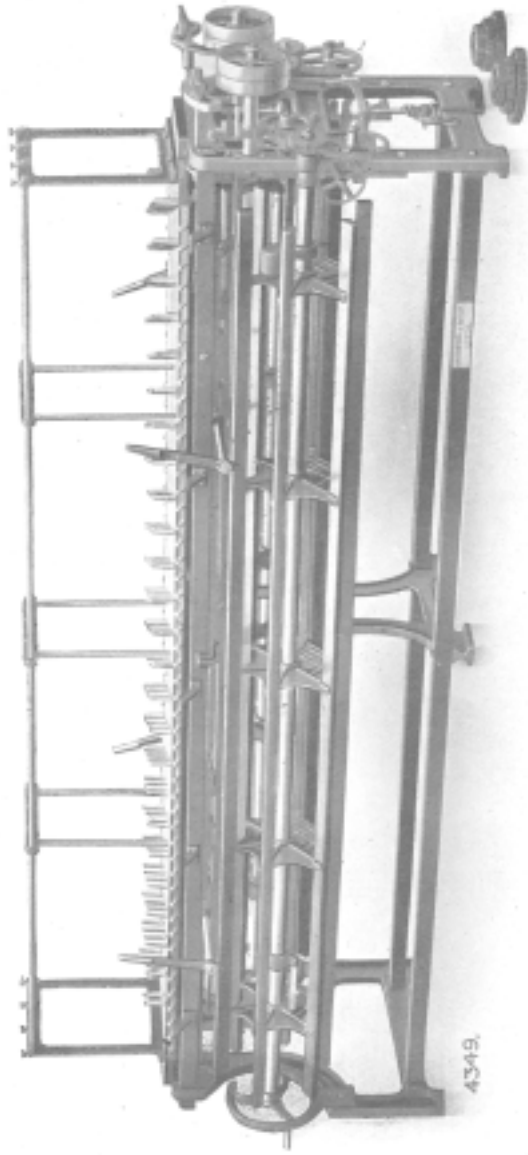

POWER REEL FOR RAMIE.

market. The annexed is an illustration of a machine used largely for the former purpose. It has 32 lights on each side, is fitted with a creel, 12 clearing runners per light, and has a traverse motion and bobbin driving complete.

For power reeling the machine illustrated gives good results. It has 40 bobbins on each side and fly $1\frac{1}{2}$ yards circumference.

The great desideratum in ramie spinning throughout is the production of a good yarn with the very minimum of waste. Naturally, therefore, the system which succeeds best in meeting these two essentials is the one which an intending spinner should install in his factory. But, as before stated, his success in working profitably depends on his obtaining a well prepared and degummed flasse—one which will work easily on the machines, and give a good strong cloth after the bleach. The author believes the process employed by the British Patent Ramie Mills Co. Ltd., of Staines, may be taken as a fair example of what a good average degumming process should be. Though the ramie-spinning industry has not yet reached the same dimensions in Great Britain as it has done upon the Continent of Europe, yet the Continental mills, who earn the largest profits, have almost all been fitted with ramie machinery made by English machinists. According to the United States Consul at Hong Kong (Mr. A. P. Wilder), a new ramie mill, which is being erected at Kan Kong, near Canton, by some Chinese merchants at a cost of £23,000, is having its plant largely purchased in this country, and amongst other machinery are knitting machines. Extensive areas of ramie for the use of this factory are growing in the Kwangsi Province close by, and if it proves successful, it is stated, the same parties will largely increase the plant. Ramie from this district is at present being spun very successfully in France and England. A portion of the machinery will be bought in the United States. A mill has also been running in Shanghai for some few years spinning and weaving the fibre. It is owned by the Eastern Fibre Co., Ltd.; as to the value of their degumming processes the author cannot say however.

H

The Chinese Government ramie factories are situated at Hankow, and there are also various other ramie mills in different parts of China and Japan which have been fitted by British firms who make the machinery. It will be noticed that in this system, as the bulk of the percentage of loss made in dealing with the fibre from the degummed state to spinning is returned in noil, the actual waste is only equal to the waste which is made in flax spinning, and the best English ramie spinners state that they find the cost of the whole of the operations in labour, power, and waste to be no more than the same costs which arise in spinning flax into similar descriptions of yarns.

Some mills who have spun the fibre, and others which do so to-day in this country and abroad, have made their own machinery, and among these are mills who have favoured the use of combing machines, after the passage of the fibre through gill machines, very greatly. Many of the machines employed in all these methods are intricate, and special in construction, and their working parts cannot be described in anything like a clear manner within the scope of a book of this size. But those who are interested in the fibre can at any time inspect the machinery made for its spinning and weaving by the firms who make a speciality of this on their floors in progress, and yarns and fabrics produced by the same in their show cases, and, further, view the machinery at regular work in some, at least, of the factories which they have fitted either in this country or abroad.

Ramie waste manufactures into many grades of high-class paper very successfully. Its great strength and silkiness fit it well for this purpose, and also for mixing with the other materials used in paper manufacture. It gives a good body and finish to the paper, and takes colours and tints very well. From the gums and resins obtained in degumming toilet soaps have been cheaply made.

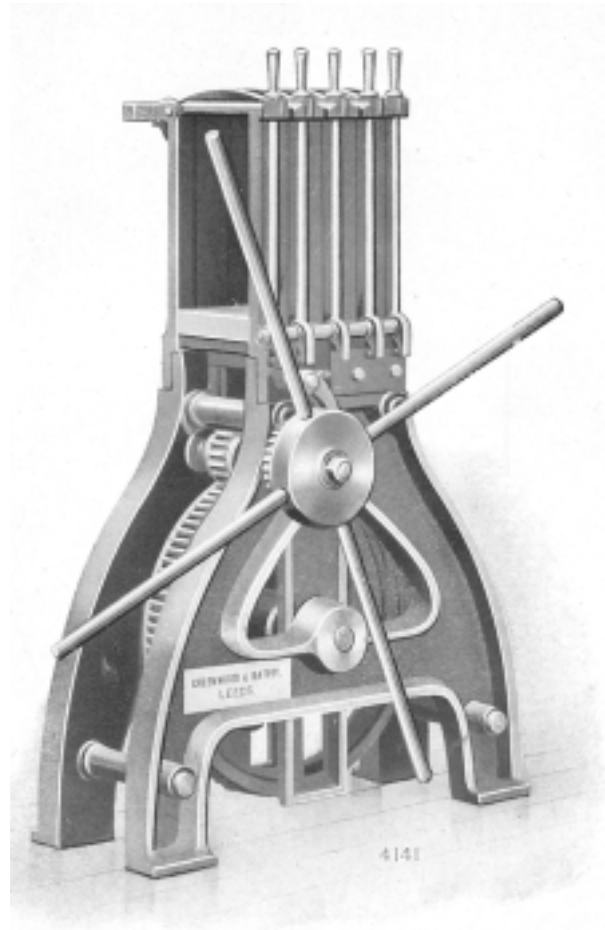

BUNDLING PRESS FOR RAMIE.

CHAPTER IX.

**The Weaving, Dyeing, Printing, and Finishing
of Rhea, China Grass, or Ramie Fibre.**

WITHIN recent years some of the very finest descriptions of fabrics have been, and are being, woven from ramie, and made use of by Royalty, giving satisfaction in all respects. On the occasion of her recent tour in India, H.R.H. the Princess of Wales carried with her, and wore, an assortment of costumes manufactured from the fibres.

None of the difficulties at first encountered in preparing and spinning the fibres have been experienced in connection with its weaving, and ramie yarns will weave on any loom. Still, improvements and modifications have been introduced to permit of ramie being woven to the very best advantage. The same may be said in regard to the warping, winding, sizing, beaming, etc., machinery generally employed.

The windows of mills in which the fibres are being woven, should be kept shaded from the sun. This is found to render the weaving more satisfactory, as if the effects of the sun are allowed to be experienced to their full extent inside the factory they have a detrimental effect on this process.

The processes employed for dyeing, printing, and finishing rhea, China grass, and ramie fabrics vary greatly. They are regulated by the various classes and qualities of the materials. They take the dye well, and are thoroughly well suited to these processes. The author has seen large quantities of ramie goods dyed and printed for the markets in some of the most delicate shades and tints imaginable. In all cases the colours were perfectly uniform, deep, bright, and fast, and the natural lustre of the fibre showed up to full advantage. The same may be stated of printed effects, the colours all being clear, showing no tendency to

run into one another or blotch; and the discharge styles were all that could be desired, the white colours being perfect.

In dyeing ramie and silk in combination, it may be observed that special dye-stuffs are requisite, the one being a vegetable and the other an animal product, yet the best results can, with moderate care, be obtained. It is well, however, to keep ramie and silk goods, and other textiles in fact, destined for dyeing separate from each other strictly in the process, as particles of the one alighting on the other are apt to cause defects in the dyeing. The fibres take the dye and print well, not only alone, but when woven mixed with other vegetable fibres and silk.

When woven into house linens, damasks, and similar goods, ramie materials are finished in the same way as linen goods. When woven into brocades, dress goods, and like materials, often made from silk, or when woven with a mixture of silk, such as, say, silk warp and ramie weft, or silk weft and ramie warp, the goods are finished very nearly in the same way as silk goods. Between these two classes various descriptions of silk goods are made of ramie and wool, worsted, flax, and cotton, and they are finished in the same manner as the goods they may be intended to compete with.

The machinery employed at the present time for making curtains, hosiery, sewing threads, cords of all descriptions, fishing and other lines, twines, ropes, and goods of a similar class, is well suited for making them of ramie also, so the manufacture of these goods calls for no special comment.

CHAPTER X.

Ramie, Rhea, and China Grass in Great Britain.

It has been said in preceding chapters that the merits of ramie were urged upon Dundee manufacturers in 1853, and generally it may be stated that about this period attempts were made to manufacture the fibre. Mr. J. Hill Dickson, who gave very considerable attention to improving existing methods of growing and retting flax, investigated the matter, and invented a process by which he "cottonised" rhea. It was by this system made into cordage, ropes, and different classes of coarse goods, but it was found that the cost of producing these was in excess of the prices asked for similar goods made of flax. A little later the Wakefield China Grass Company was established, and a Mr. Bonsar acted as manager of this concern, which, in the same way, succeeded in spinning and weaving various classes of yarns and cloth from China grass fibre, and it would seem as if profits were at different periods made by this concern. Unfortunately, however, a fire broke out on the premises after the mill had been working for some years, and they were totally destroyed. This had its origin not in any technical shortcoming, although the methods employed in treating and manufacturing the product were not nearly so advanced as those in use to-day, but arose in the warehouse, as fires often do. During more recent years mills have been established in two or three other directions in this country. One of these, situated in the Midland Counties, was a fairly large concern, and undertook, in addition to the spinning and weaving of the fibre, its dyeing in a varied range of beautiful and high-class colours and styles. During the first two years of its existence it produced an exceptionally fine description of yarns and fabrics. The latter were woven pure and mixed, and there is little doubt that owing to the effective and economical methods which this concern during its early existence had the use of for

degumming, preparing, and spinning the fibres, this mill would have proved remarkably successful. At the end of this time, however, changes took place in its administrative staff which necessitated the adoption of another system of degumming, which caused them, it is stated, to lose the connection they were establishing among silk manufacturers and weavers of linen goods, in spite of the high prices then ruling for China grass. Their later productions, it is said, being found to at times deteriorate in strength, the hold which they had established upon the market at the outset was lost, and the mill was eventually given up. This enterprise undertook for some years the cultivation of the plant in India. The district selected was not a very suitable one, and they did not secure the crops which they anticipated, but in spite of this would in all probability have met with success had they in the later years of the concern's existence possessed a satisfactory process for degumming China grass, and the ribbons which they grew. The other mill was situated in one of the Lancashire towns, and was the property of a local company. This mill was very well supported financially, as indeed was the last named; but errors were made in the principle upon which it was decided to carry on the business. The concern relied entirely upon the native Indian cultivator offering £7 10s. per ton for ribbons delivered at port of shipment, and £10 per ton for the same product laid in London. These prices failed to bring supplies very signally. In many instances they showed no profit whatever to the cultivator, who then found it more remunerative to raise other field crops. Adding to this the high price of China grass; uncertainty of supply; the mills being often stopped for serious periods through lack of these; and the fact, possibly one of the chief causes of their failure, that instead of considering the peculiar needs of the fibre in regard to preparing, spinning, and weaving, and selecting premises, and fitting the same with modern plant and machinery, upon which these processes would have been economically and satisfactorily carried out, they acquired and utilised existing mills, endeavouring to adapt the silk-spinning machinery which they

contained to meet the requirements of ramie, it is not hard to understand that the combined difficulties which came upon this company proved more than it could stand against. The firm whose mill they took over had been in the habit of spinning ramie on their silk machinery from time to time, but their plant was not new, and those intimately acquainted with the circumstances consider its adaptation a heavy loss financially, and the results to have been incapable of meeting the requirements of the fibre in a satisfactory manner. The silk trade was decidedly depressed—at times very depressed during the run of these two mills,—and the linen trade not over brisk. Undoubtedly this latter mill had to pay a very much higher price for rhea, or ramie, ribbons when they were able to secure them at that time, about 1892 to 1898, than what they offered, and when these could not be obtained, and the prices of China grass were prohibitive, they were compelled to undertake the business of silk spinners, any losses made in which would have been placed to the debit of the mill as a ramie spinning and weaving enterprise.

For many years, however, ramie mills have existed at Staines, near Wraysbury, which carry on a profitable British trade, producing good strong medium and superior quality yarns and cloths, and offering the material also to the trade in the form of a sliver at about 1s. 6d. per pound. Works and mills for the treatment of the fibre are also to be met with at Bredbury, Cheshire, and at Mellor, Derbyshire. Sailcloth, other goods, and large quantities of incandescent gas mantle bases are manufactured at these premises, and the enterprises have been at work successfully for some years. In racing his yacht *Shamrock I.* for the American Cup some years ago, it may be observed, Sir Thomas Lipton had her sails made of ramie instead of flax, which, as a yachtsman, he preferred, and he gave a testimonial to their makers as to their superiority. At Selby, in Yorkshire, the preparation of rhea, or ramie, and its spinning into yarns, peculiarly suited in many cases to the needs of the worsted and woollen trade, has been for several years carried on by a large Yorkshire firm of

manufacturers, who seem to find the undertaking a profitable venture. At any rate, this mill has been running some time. Weaving of rhea and ramie textiles is also undertaken by this firm.

The manufacture of the fibre has been experimented with from time to time in many districts in this country—notably in Macclesfield, Huddersfield, Belfast, Rochdale, Salford, Leek, and Brighouse, and there may, for all the author is aware, be other firms engaged in its treatment than those already mentioned. Certainly the yarns are being woven in many widely varying directions, and put to use for home and export purposes. When the culture of the fibre becomes more general in India and the British Colonies, there is no doubt that the manufacture of rhea, or ramie, fibre will become general, and the yarns will be utilised to a very much larger extent in commerce in this country than they are to-day, with considerable benefit to the manufacturers of other textile fibres and the British silk industry. For the time being Germany, France, and the United States lead the way in what gives promise to be a new and important manufacturing industry.

Some millions of English money are annually spent abroad in the purchase of the finer qualities of flax, which are imported into Great Britain for the purpose of spinning and weaving, very frequently in combination with Irish-grown flax. Rhea, or ramie, would take the place of these descriptions of foreign flax with thoroughly satisfactory results—in fact, it would be far cheaper and better, and the linen manufacturer would secure larger profits in his business in the near future by making use of these fibres in place of them, the gold exported would go to India and the British Colonies, and the profits on the industry remain in this country as hitherto have those arising from the British manufacture of foreign-grown flax. Prices for the raw product would not be subject to greater fluctuations than flax quotations, and the saving of the large annual export of gold which these flax supplies necessarily entail upon this country could not fail to be attended with a general marked and continued improvement in trade in Great Britain, the

good effects of which would soon make themselves felt in all industries. The larger the yearly export of gold to countries which fail to do a corresponding trade with this, the more the industrial well-being of the whole country is certain to be adversely affected by increased bank rates and other circumstances. This is a feature in political economy which no one will for a moment seek to prove to be a fallacy, and the question arises, does Great Britain receive anything like an adequate return in trade annually from those countries to which it goes to-day so largely for flax supplies?

The following figures published by the authority of the Board of Trade represent the total value of flax purchased by this country for the year ended 31st December, 1907: Russia, £2,135,250; Belgium, £1,148,928; Holland, £143,392; other countries, £30,985. Tow purchases: Russia, £348,653; other countries, £135,399; or a total expenditure for flax and tow imported into the United Kingdom of £3,942,607 for the year, which was not a very busy one for flax spinners.

From Russia our imports, including flax and all other merchandise, amounted in the aggregate for the year to £31,423,088; from Holland, £36,831,888; and Belgium, £28,291,426. The value of our exports for the same period to these countries: Russia, £11,144,365; Holland, £13,977,740; and Belgium, £19,354,022; so that it will be seen, leaving flax supplies out of the question, we purchase from these sources each year considerably more merchandise than what they buy from us—roughly, some forty-eight million sterling.

While the value of flax imports cannot be compared with that of the cotton, wool, and silk, which we purchase each year in the raw state, it yet reaches a very large figure, and the probability is that by far the largest portion of goods made from these supplies are consumed in Great Britain or the Colonies. Further, it is needless to add that the amount would be still greater were it not for the fact that certain grades of flax can be grown successfully within the United Kingdom, and in regard to the other products it must of

course be borne in mind that save in the case of wool these cannot be produced at all within the confines of the British Isles. It is improbable that Ireland could be made to grow each year the amount of flax which we import, and it certainly could not be made to produce several of the finer qualities which we import so largely, especially from Belgium. Degummed in a satisfactory manner, and rightly combed afterwards, ramie is quite equal to these in regard to fineness, strength, elasticity, ductility, and all those other good qualities which go to comprise a textile fibre, and while it differs from flax in the way of possessing a natural silky lustre, which flax is lacking in, this can be, if necessary, largely removed from it in its degumming without damaging its strength or good spinning properties, so rendering it to all intents and purposes an identical fibre in appearance to flax, while considerably cheaper. To some extent this silky lustre, which fits it so admirably for weaving in combination with silk, and using with other textiles to impart silk effects to them at little cost, militates against its selling freely in Great Britain in competition with flax when it is woven into pure ramie cloths. In many instances the difference between the appearance of the two fabrics is, in fact, in favour of ramie, as being the most valuable. Viewed from a textile standpoint, it is a superior cloth, but it looks somewhat strange and new to the buyer when its full lustre is preserved in manufacture, and the buyer may consider in some cases that an attempt is being made to sell him some showy, inferior substitute in place of a fabric with which long usage and custom have made him extremely familiar in a domestic and general way. But a close examination of the cloth, if he takes the trouble to make it, will convince him of its intrinsic merits, and if it has been produced in a good ramie mill its after-wear will fully justify the greater appreciation which he has in this way shown for the material, and he will, in the majority of instances, have saved money by the preference which he has shown for it in making his purchase.

The prices charged for ramie fabrics are, of course, always dependent on the cost of raw supplies at the time being to the manufacturer who has produced them. The present price of China grass is £24 to £32 per ton, and ramie ribbons, or bark strips, about £14 per ton, delivered London. The larger the raw supply which is on the market for the moment the cheaper will be the materials. The mills engaged in the trade specialise in their productions—some centring their attention on the manufacture of products which require no bleaching; others upon the weaving of incandescent gas mantle bases almost entirely; and again others in the weaving of fabrics for the use of the public generally for the purposes of wearing apparel and domestic use.

When it is rightly dressed and combed ramie is the most beautiful of all known vegetable fibres.

Selling at £10 per ton, planters in most ramie-growing districts should have a good profit on culture.

For ramie spun in linen counts, the following quotations were very recently given by a Bradford firm, who are agents for ramie mills not far distant, and they are illustrative of prices as they stand on present cost of raw supplies; 300 yards go to the lea.

Singles: $\frac{20's}{2/1}$ $\frac{30's}{2/1\frac{1}{2}}$ $\frac{40's}{2/2}$ $\frac{50's}{2/2\frac{3}{4}}$ $\frac{60's}{2/3\frac{1}{2}}$ $\frac{70's}{2/4}$ per lb.

Folded up to six fold $\frac{1}{2}$ d. per pound more. 285's linen 2s. 7d. per pound, net cash, delivery free, and either in hank or on cheese. The singles can be delivered on weaving tubes or in ball warps.

CHAPTER XI.

**Ramie, or Rhea, Fibre on the Continent
of Europe.**

THE progress which ramie, or rhea, fibre manufacture has made of late on the Continent of Europe cannot fail to be a matter of very considerable interest to manufacturers and merchants in Great Britain, the United States, and generally. The declaration of substantial profits by Continental spinners of the fibre during the past five or six years will come to those who in this country have advocated its claims to recognition as a valuable textile, and who have urged upon the Government the desirability of taking action through the India Office, with a view to settling the question of the suitable rhea-growing areas of India officially, as a very conclusive confirmation of the opinions which they have formed in regard to the merits of the fibre; while those who have for so long persisted in maintaining that it possessed natural defects which would prevent it ever being manufactured profitably will find it hard to reconcile the views which they have so lightly put forward, accompanied not unfrequently with many misrepresentations, with existing facts, which are stubborn things and hard to get over.

France has been the pioneer country in the industry on the Continent, and the P. A. Favier Company, established some thirteen or fourteen years ago, whose mills are at Entraignes, may be unhesitatingly described as a growing and profitable undertaking. This firm employ some 400 operatives. Their mills are electrically lit, driven by turbines, and they own the dwellings in which their operatives reside. Some years ago the company built a fairly extensive dye-house, in which dyeing operations in connection with ramie and China grass textiles are carried on.

Small quantities of ramie in the form of sliver are imported into France from Great Britain at about 1s. 6d. per pound, and of combed ramie from this

country and other parts of the Continent at about 1s. 4d. per pound, for the purpose of spinning.

The British Consul General at Paris reports that ramie textiles are preferred in many parts of France to linen, being found to stand wear and repeated washings better. Some years ago the French Transatlantic Steam Navigation Company adopted the use of the fibre generally in place of linen on all their ocean-going steamers, and have since utilised it in this way. Large quantities of the fibre are also used each year in the Government rope and cordage factories.

Another company is also engaged in degumming and spinning the fibre in Paris, organised some little time after the last named, *Le Société Française Industrielle et Commercial de la Ramie*.

The bank of France use paper made from ramie waste for their note issues, counterfeiting of which is by this means rendered impossible, and paper made from the same waste is supplied by a French firm of papermakers, it is stated, to the Bank of Russia, who use it for the same purpose.

The quantities of ramie imported into France from China, and of combed ramie imported from other countries, during the following years are as under:—

		<i>Combed Ramie.</i>	
1903 ..	1,020,000 kilos.	1903 ..	1,400 kilos.
1904 ..	1,390,700 kilos.	1904 ..	35,900 kilos.
1905 ..	1,058,595 kilos.	1905 ..	1,416 kilos.
1906 ..	940,800 kilos.	1906 ..	nil kilos.
1907 ..	1,524,800 kilos.	1907 ..	11,900 kilos.
1908 ..	1,733,500 kilos.	1908 ..	100 kilos.

Ramie is not separately distinguished in the official import returns of Holland, Belgium, Switzerland, and Austria. The manufacture of the product is also undertaken by Messrs. P. Riousett and Cie, Paris, who have been established some years, and possess a good plant for treating and spinning the fibre; and another fairly large enterprise is engaged in the trade in a similar manner at Bellegarde s/V. This concern has been at work for some few years, and is stated to be making

satisfactory progress, the erection of a branch filature being contemplated by them at Lyons some little time ago. Whether this latter has been erected the author is unaware, but the matter was, or is, under consideration.

In Germany the progress made in ramie and China grass manufacture since its introduction about twelve years ago has been very considerable and remarkably profitable, and the German Government, it may be observed, is fostering the trade very greatly in order to make them as far as possible independent of outside flax supplies. The principal German mills are situated in Emmendingen, in the Duchy of Baden, and are owned by the Erste Deutsche Ramie Gessellschaft (First German Ramie Company). This concern has been very successful, never having failed to distribute a dividend, and nearly always an increasing one, since the inception of the company thirteen years ago. They are said to grow ramie to some extent at Emmendingen for their own requirements, and to use the Faure decorticator for the purpose of decorticating the product of the fields.

The quantity and value of ramie imported into Germany from China during the following years are as under :—

1903:	1,146,100	Kilos.	..	Value	Marks:	974,000
1904:	1,082,400	"	..	"	"	920,000
1905:	1,390,400	"	..	"	"	1,182,000
1906:	1,549,800	"	..	"	"	1,318,000
1907:	1,924,300	"	..	"	"	1,599,000
1908:	2,508,700	"	..	"	"	2,010,000

1907 imports include 136,700 kilos. combed ramie from other countries.

1908 imports include 73,200 kilos. combed ramie from other countries.

1 kilogram = 22,046lb. 1 mark = 11.8d.

The exact dividends paid by the Erste Deutsche Ramie Gessellschaft, of Emmendingen, are: 1897 5%, 1898 5%, 1899 5%, 1900 7%, 1901 7%, 1902 7%, 1903 8%, 1904 8%, 1905 10%, 1906 12%, 1907 15%, and 1908 15%.

It will be noticed that a very marked increase in dividends has continued since 1904.

The price paid for combed ramie imported into Germany is about 8d. per pound.

The fibre is also degummed and spun by a company at Grevin, in Westphalia, on a commercial scale—this concern has some £20,000 capital, it has been at work for the past three or four years, and its plant and buildings will shortly be considerably enlarged,—and by another firm who also prepare and spin flax at Frieburg; and mills which weave ramie yarns exclusively exist in Berlin.

In 1905 the Emmindengen Company erected new buildings and laid down an extensive new plant and machinery, but their trade has been confined so far almost entirely to the spinning of medium counts of yarn, and they are said to possess a degumming process, in addition to the one which they use as a rule, which cottonises the fibre, and which is employed for special goods.

A considerable trade in ramie yarns and textiles is done between the German mills and the United States, though not so large as a few years ago. A consular circular recently issued in Germany describes the Chinese grass cloth as a material made in China from ramie (*B. nivea*) very extensively, and as the product of a home industry in Canton and its vicinity. Thirteen different kinds of cloth are made, it states, embroidered and plain, to measure, for coverlets, pocket handkerchiefs, and also in pieces of 20 yards in length and 34 inches wide. The largest consumers are Great Britain, France, Germany, and the United States. The material is hand prepared, the Chinese workpeople being paid at the rate of about 6d. per day.

The Emmindengen Company have a large capital. They do not spin very fine counts of yarn, but are stated to be contemplating altering their machinery to enable them to spin finer.

The French filatures may be said, next to English ramie mills, to produce the most high-class fabrics from the fibres, and their degumming processes may

possibly be superior to others made use of on the Continent. They import their raw supplies to some extent from Tonkin and Algeria, and seem to be fairly successful in degumming ribbons imported from these Colonies.

In Switzerland ramie filatures exist at Zurich and Neideruster. In these factories the fibre is spun into yarns for weaving into pure ramie and China grass cloths, and for mixing with cotton, flax, wool, and silk, pure ramie cloth being manufactured, it is stated, for scenic purposes in opera and concert halls, and large quantities of incandescent gas mantle bases, or stockings, are woven. Two or three years ago the trade in ramie textiles in Switzerland, produced by mills in that country, was reported to have somewhat declined, but it has lately improved.

The British Consul at Zurich states that there was lately an idea in Switzerland of using ramie for making driving bands, but the raw material was found to be too expensive; also for ropes used on the yachts on the Swiss Lakes, as ropes made of ramie are superior to those made of hemp. Messrs J Delacroixriche, a leading firm of ropemakers at Geneva, state that if the article becomes cheaper they personally could use thousands of kilos. each year, and if any firms can supply them cheaply, they add, they will be pleased to hear from them.

In considering the profits made by the chief German, French, and other Continental mills who degum and spin the fibre (the profits of the Emmindengen Company for the year 1907 amounted to £44,868, those for 1908 to £37,273; this is a decrease, possibly due to the opening of ramie mills in the United States), in comparison with those earned by English mills in their home trade and export to the East, and to other British possessions, it must be borne in mind that wages on the Continent generally are somewhat lower than those paid in Great Britain. At the same time, however, it is quite possible that the work is not as economically carried out as it might at first be thought, owing to the volume of production not being equal to that obtained in this country.

A ramie factory was established in Holland some five years ago to open up a general trade in ramie and China grass yarns, and in the manufacture of incandescent gas mantle bases, and though many difficulties were at first encountered in connection with the treatment and manufacture of the fibre, this concern, which is well backed financially, has succeeded in overcoming the technical obstacles which cropped up, and is making a profit on its trade which there is little doubt will gradually grow to large proportions.

In Sweden a fairly large and successful filature has been engaged in degumming, spinning, and weaving the fibre for several years. This mill is situated at Karlskrona, and manufactures hygienic ramie hosiery. The factory possesses a very complete plant for the treatment and manufacture of the fibre, and, in addition to the making of hosiery, yarns are spun for weaving with other textiles and silk into various descriptions of goods, which command a ready and profitable sale.

So far as the author is aware, there are no Chinese grass or ramie filatures in Austria, although one small mill existed at Bregentz until about three years ago, when, owing either to depression in trade or other difficulties, it was liquidated.

In Italy there are no ramie mills, but one firm in Naples, and doubtless several others, import the yarns and fabrics largely, and find a profitable market for them. The Naples firm sent a case of exhibits of ramie textiles to the Tourcoing Exhibition in Northern France in 1907, where they were favourably commented upon.

The culture of ramie has been experimented with in both Russia and Spain, as has also been the case in France, and some few years ago it was proposed to establish China grass and ramie factories at Moscow. But for some reason or another, most probably the fact that Russia is the largest flax-producing country in Europe, and in addition to supplying her own needs with respect to flax largely keeps working the flax mills of Great Britain, France, Germany, and other Continental countries, the project was not proceeded with,

I

though considerable interest is taken in the fibre by Russian merchants, who undoubtedly import it more or less largely. The anticipations formed in regard to the successful growth of the plant in Russia and Spain would seem, as in the case of France, not to have been realised.

Judging by the prices which French spinners pay for the supplies of combed ramie which they import, either a finer description of ramie yarns and textiles is produced in France therefrom than is spun and woven in Germany from the German imports, as the material passes through more advanced preparation, or the product imported into Germany is further combed in the German mills. As before stated, however, in the case of exhibits of ramie materials produced on the Continent, it has been found, as a rule, that the French weaves were of a finer description than any others, and the same efforts to produce such goods as art linens and damasks and silk substitutes would not appear to be made elsewhere on the Continent. Therefore, the former seems to be the explanation of the higher prices paid for combed ramie imports in France.

CHAPTER XII.

Ramie, or Rhea, Fibre in the United States of America.

THE United States cannot be said to be a flax-producing country, considering its size, and so for many years the fibre of ramie has received a very considerable share of attention from manufacturers and merchants generally. Attention would appear to have been first directed to it at the time of the Civil War, when the cotton crops were neglected, with consequences which led to the question of the spinning and weaving of ramie, or rhea, fibre being raised in Europe. The matter has been investigated by the Department of Agriculture, and four small growing experimental stations were established by the Government some years ago, who at the same time placed the yarns upon the tariff list. It

has never been cultivated in America on a commercial scale, but experiments conducted by private parties, State experiment stations, and by the Department have demonstrated that it can be grown successfully on suitable soils from Maryland to Texas, and in California from Sacramento southward. In American culture its roots are injured where the ground freezes more than two inches. It appears to some extent remarkable that the much desired machine for decorticating the fibres has not ere this emanated from the machine shops of some of the American firms of machinists, judging by the many new and valuable machines which engineers in the United States have, within recent years, placed on the market to the great benefit of textile manufacturers in all parts of the world. Possibly the Schlichten machine may prove to be this.

The fibre has been treated and sailcloth manufactured from it in Providence, Rhode Island, and a decorticator and processes for treating the fibre were some years ago invented by Mr. S. B. Allison, of New Orleans. Mr. Allison, who appears to have concentrated his attention chiefly on the decortication of the product, constructed a machine for the production of ribbons, and experimented in the growth of the fibre in the vicinity of New Orleans. In this city, some five years ago or so, the United States Government held a series of ramie-decorticator machine trials, and some years prior a conference of American manufacturers, which was fairly well attended, was held at Trenton, New Jersey, with the object of considering the possibilities of the ramie-manufacturing industry generally, and the prospects of the same being profitably established in the United States. The result of this conference was a resolution being passed to the effect that while there appeared to be a prospect of this proving the case, it would not be wise to proceed with the erection of ramie mills until such time as a machine was placed upon the market which would solve the problem of the separation and cleaning of the fibre in an economical and effective manner.

Mr. Charles Richards Dodge, who, as Special Agent in

charge of Fibre Investigations to the Department of Agriculture, Washington, was appointed to investigate the question generally by the United States Government at this time, about 1894, and who for this purpose visited the likely ramie-growing districts of the United States, and also made a special journey to Europe in connection with the matter, makes the following remarks on the subject in a report which he prepared and submitted, a year later, to the United States Government. In this report he says :—

“ Facility to imitate all other textiles is one of the principal causes which has kept back the development of the ramie industry, and if instead of launching out into a series of experiments, attention had been concentrated upon the exclusive manufacture of those articles from the fibre for which it is peculiarly and naturally adapted, this industry would probably be in a more advanced condition than it is at present. The folly of building up a ramie manufacturing business on a false basis—that is, employing the textile as a substitute for something else—is to be deprecated. The fibre should be used in those articles of economic necessity which would appear on the market as ramie, that any distinctive merit the textile may possess will become known not only to the ramie trade, but to consumers of the produce.”

Since that time he has attended various machine trials which have been instituted by the Government, and from the report which he drew up, and which the author had the pleasure of reading, it seems that in various districts in the Southern States which he visited he found people who understood the propagation and culture of the plant, and who were engaged in growing it. They spoke in favourable terms of its behaviour as a field crop, of the ease and rapidity with which it could be cultivated, the quick growth which it made, fair yields of fibre obtained, and especially, in some instances, of the satisfactory manner in which it had stood changes in the climate of a more or less sudden and marked character, and the hardy way in which it stood the winter season, and stated they

could raise the plant if a fair and remunerative demand arose for the fibre on the part of spinners.

Ramie yarns and textiles are imported at the present time into the United States to a greater or less extent from Europe, and have been for some years, especially large quantities of incandescent gas mantle bases for use in connection with the Welsbach system of incandescent gas lighting. Recently a plant capable of treating fourteen tons of raw material weekly was laid down by the Howard Ramie Fibre Company, of 18, Park Place, New York City, and mills to degum and spin the fibre and China grass are now being operated by Mr. J. Kingsland Sargeant, junr., of 118, Arch Street, Philadelphia.

In addition to those mills named already ramie is also spun and woven by the Schlichten Ramie Manufacturing Company, of 473, Broome Street, New York, principally into hosiery, underwear and knit goods and superior ramie linen fabrics. This concern has been at work for some years, and is establishing a large trade in competition with ramie goods manufactured in Europe. It is stated to possess very effective and economical processes for degumming and manufacturing the fibre, has taken various gold medals for its manufactures from the fibre, and is undoubtedly one of the leading ramie enterprises in the United States. The class of ramie goods most extensively used in the United States is knit-ramie underwear. Within the past few years, however, increasing quantities of ramie yarns are being imported from various European countries, and they are used in mixtures with silk goods. The fibre, especially the noils, is also imported to be spun with silk at Paterson, New Jersey, into yarn, and woven to be used with silk. The processes in use so far, as is generally known, are mostly based on the researches of the late M. Fremy, of the French Institute, but in different mills the actual chemical formulæ used in the details of the processes are varied to suit the requirements of the particular kind of fibre desired. The Philadelphia Company's mill is situated at Danbury, Conn. The largest portion

of the fibre spun is produced at Paterson, New Jersey. The China grass consumed in the United States is obtained chiefly from Formosa. In the production of the ramie underwear used so largely in America the elasticity needed is provided for in a Swedish factory in the knitting stitch. The outlook of the industry in America is now more promising, Mr. Dewey states, than at any time heretofore. The market established within the past five years for knit ramie underwear and hosiery is increasing—a mill for the manufacture of ramie incandescent gas mantle frames has been put in operation within the past year; a mill for degumming, bleaching, combing, and spinning ramie fibre is now being equipped; and another mill already equipped for the work is beginning to make ramie towelling. Increasing quantities of ramie are being also used in the manufacture of union silk and ramie goods. It may be remarked that Mr. Dewey gives the yield of fibre to be at the best a little over six per cent. of the weight of the dry stalks. This is slightly more than that stated by Indian authorities as the yield in India.

There are doubtless several other directions with which the author is unacquainted in which ramie is being manufactured in the United States into various special classes of goods for which the fibre is especially fitted, in addition to general descriptions of pure ramie and mixed fabrics, and which meet with a ready and profitable market—in fact, it is almost certain that there are. There are undoubtedly at least a few good systems for treating and manufacturing the fibre in existence in the country which will be set in operation when there is a greater certainty of ample suitable raw supplies being available than can be obtained at the present time from the South or outside sources.

The consumption of German ramie manufactures in the United States was very extensive about four years ago, but has since fallen off, owing to home production.

CHAPTER XIII.

Ramie in South Africa.

THE improved position of South Africa has opened up the country more fully for Europeans and others, and it is a district of great possibilities. Accordingly the prospects of ramie in the country call for notice. Efforts there have up to the present been limited to the laying down of experimental plots of about a few acres. It will not grow on the Cape sand flats, but near Capetown can be grown in sheltered spots, and it has been raised near Port Elizabeth. The general results are better moving East and North in the Cape. The Kalahari is unsuitable, and so is Bechuanaland. In the Orange River Colony culture does not answer, except in very sheltered situations. At Modderpoort ramie plants are thriving well at the present time, but experiments in extending the growing area have not proved so successful, and the possibilities of ramie proving suitable to the high altitudes and exposed plains are small. No characters of the plant have been developed here to warrant extension. The Government Agriculturist in the Transvaal reports that silvery ramie, *B. nivea*, seems to thrive well in the Transvaal, more particularly in the warmer and more-sheltered spots. It gives one cutting in the season on the high veld. None has yet been grown in Swaziland. In Mazoi and Marandellas districts, Rhodesia, it has succeeded. The best results have been obtained in the South Melsetter districts of Rhodesia, where the altitude is not so great and the land good, well valued, and the country sheltered.

To grow at a profit, the Western side of Cape Colony, the whole of the Orange River Colony, and Southern Transvaal and Matabeleland should be avoided. On the Eastern side transport difficulties, it is thought, would kill the industry. At Greytown and Ixopo, in Natal, it is possible to get two crops of good fibre. It has been planted at Cedara, where Faure's hand-type machine has been used, but it does better in the warmer climate

of Maritzburg than on the high veld of Cedara. In Maritzburg town four crops have been grown in a year. It is cultivated in the Town Bush Valley, and in Willowfontain district; also in the Weenen district, where it produced two good crops. It will grow at Port Shepstone, at the Umizunimi, Umbwalumi, and Umizinto. There is a good crop on the Government farm at Winkle Spruit, and there are crops of about 2,000 to 3,000 plants at various points on the coast. The district, generally speaking, which is the best for ramie culture at present is a belt on the Eastern side of South Africa, not less than two miles from the sea on one side, and on the other more than 2,000 feet high—one authority puts it at 1,000 feet,—starting from Port Elizabeth on the South and stretching North into Portuguese territory. Outside this, apart from exceptional pieces of land, the district is unsuitable. Very wet ground or stiff clay ground does not answer. Flooding, frequent change from hot to dry weather, too heavy rains (which make an irregular growth of fibre), frost, and wind, are all detrimental. The best soil is a red, and this is preferable to a black one. It should be 18in. deep, sheltered, and the rainfall distributed evenly over the year. Where these conditions are observed it may be possible to get four crops a year, it is reported, which would pay. It is necessary to dig deeply between the rows every year to give the plants light and air. A sample of ribbons sent from Maritzburg has been stated to be of good quality—worth about £10 per ton. The Aquilles Decorticator, a German machine, is stated to have been used in South Africa, and to have produced a good marketable article. Another machine has also lately been tried, the Andrewe. This is English, and in it is substituted for the stroke of the Faure and the last one named a soft combing motion, which it is claimed is less detrimental to the fibre. The difference in the cost of labour—it averages 1s. 6d. per day in Natal—would diminish the profits of growing in South Africa, but as there would be an increase in the seventh and later years to the tenth, as the plant gives an increased yield, and there would not be the

cost of planting to be reckoned as in the first period, these would increase. *B. tenacissima* is stated to have yielded, in culture experiments, twice as many canes as *B. nivea*. An African authority states that in Jamaica friends of his have found *B. nivea* growing on the hills and *B. tenacissima* at lower elevations.

CHAPTER XIV.

The Uses to which Ramie, Rhea, and China Grass Yarns Can be Put in Trade.

THE uses to which ramie, rhea, and China grass yarns can be applied are as manifold and diversified as the merits of the fibre as a textile.

As the strongest of all fibres, and by reason of its non-liability to rot when immersed in water, it is especially suited for the manufacture of sailcloth, tent canvas, ropes, cords, fishing lines and nets, and all similar descriptions of goods subject to being exposed continually to the changes of the weather. For these purposes it is unquestionably superior to all other textiles in regard to its lasting properties. Being lighter than flax, vessels can with safety carry a greater expanse of ramie sailcloth than if their canvas were manufactured from the latter fibre. Woven into tent canvas for military purposes, tents made from the fibre can be transported from place to place in less wagon space than when flax is employed for this purpose—a great desideratum in ordinary times, and during warfare a matter of the very first moment. Fire-engine hose it is especially adapted for; also belting and girths, filter cloths, towellings, shoe laces, and a great variety of other goods.

In the manufacture of all descriptions of waterproof goods it proves more serviceable than cotton for the purpose of linings, as it withstands the heat much better at which the rubber has to be applied to the lining.

Ramie can be spun into exceedingly fine yarn, as high as No. 168's having 50,400 yards to the pound.

Fine yarns of this kind used for the manufacture of the best qualities of goods can be used to mix with silk yarns ; as, for instance, a ramie warp with a silk weft, or a silk warp with a ramie weft.

The best quality of fibre is spun into yarns used in the manufacture of brocades, damasks, fine tapestries, hat linings and neckties, linings for gentlemen's dress suits, plushes, velvets, lace goods, ladies' dress materials, and goods which can supersede some of the finest qualities of linen.

The medium quality is spun into yarns used in the manufacture of scarves, turbans, pongees, pocket handkerchiefs, velveteens, medium linens, hosiery, wool, and ramie mixtures, sewing and other threads, fishing lines, fire hose, belting, girths, and many other goods.

The third quality of fibre is spun into yarn used in the manufacture of ordinary woven goods of many descriptions, such as canvas, sailcloth, and towelling ; also for cords, lines, etc.

For the parcelling or wrapping of any kind of produce which is forwarded to the seller in a more or less damp condition, but which it is desired should be fairly dry on arrival at its destination, ramie cloth, by reason of the way in which it absorbs and quickly throws off moisture, would be far more suitable than flax, jute, or any other fibres now used for this purpose.

For insulating purposes it is particularly well suited, and excellent motor-tyre canvas and mosquito curtains are manufactured from it. It is also made into different waterproof specialities, crochet, sewing threads, etc.

The degumming processes possessed by some mills produce at not more cost a far superior textile from ramie than others more suited for the manufacture of fine linen fabrics, and for mixing with and substituting natural silk ; therefore, the dealer must inquire and select the mill which will give him the best value for his money, whether in silver, yarn, or cloth.

Ramie goods are quite as lasting, if not more so, than others. As an example, the Chinese have used the fibre for many centuries. Their fabrics hundreds of years

old exhibit the wonderful lasting qualities of rhea, and it is a question whether many of the mummy cloths in which the bodies of the Pharaohs have been discovered were not woven from the fibres of *Boehmeria nivea* or *tenacissima*. The author has seen mummy cloths which cannot, by reason of the silky gloss which they exhibited, even after this great lapse of time, have been produced from flax.

The yarns would prove suitable for using to give the silky coloured stripe so often inserted down cotton cloths.

To all fabrics in which they are woven ramie yarns impart greater strength and non-shrinking qualities. This latter circumstance opens a wide field for their employment in connection with long-stapled wools, which, when manufactured alone, frequently shrink; also the somewhat hairy nature of rhea, or ramie, fibre.

Sheetings, shirtings, twills, jaconnetts, mulls, Mexicans, "T" cloths, long cloths, dhooties, drills, Harvards, Oxfords, etc., can all be produced from China grass or ramie, and the silky gloss of the fibre imparts novel effects to all cloths in which the yarns are woven, as well as greater strength.

Woven in combination with cotton, and dyed and printed in the Pine and other general patterns used in calico printed materials, the cloths present a novel and very pleasing silky appearance and have a fine soft texture, and such goods should command a large sale at home and abroad, especially in the East. The same silk effect is obtained when they are woven in combination with linen and woollen goods, and in connection with Bradford Union dress materials the yarns could be well employed, especially those possessing a superior silky lustre.

The noils or short fibre of ramie, separated from the remainder of the fibre by the combing machine, are now exceedingly useful for many purposes, and there is a large demand for them. Ramie noil is never waste, unlike most other fibres. Owing to the very long staple ramie possesses, it is easily worked up again and spun into yarn. They are, when spun into yarn, mixed with other textiles, and as such their leading qualities are

strength and regularity. They might be used with advantage in different classes of carpet manufacture. These are good mixtures for the manufacturer, as ramie noils not only give great strength to the fabric, but they improve the appearance of the goods through their lustre, and through the good and lasting colours which they take in the dyeing process, and in the majority of cases they reduce the cost of the materials, for they sell at about 4d. to 5d. per pound. They are also used in the manufacture of celluloids, and for polishing ivory such as billiard balls, papermaking, etc. The paper which can be made from them is of a very superior quality, and they are used on the continent of Europe to a very large extent for lint in public hospitals, and by medical men.

Many other and special uses are without doubt open to the fibre, which can be best ascertained by the spinner and manufacturer experimenting with it in small quantities. In this way he will individually discover peculiar uses and purposes to which he can turn it to account profitably if obtainable sufficiently cheap. It is the enterprising manufacturer who makes the largest profits, and novelty fabrics produced often in the first instance at comparatively small cost, in moderate quantity, frequently take a hold upon the market which they retain, and the trade in them becomes a large and regular one, as might be shown by the present use of flannelette, the extensive sale of mercerised cotton specialities, poplin cloths, and similar other goods which have been manufactured out of the beaten and ordinary paths. The yarns are certainly, in the majority of cases, to be had cheaper than the artificial silks of the Continent, and also some mercerised cotton yarns.

For hosiery purposes they should command a very large sale, and are beginning to do so owing to the property which the fibre possesses of rapidly absorbing and throwing off moisture and perspiration, which renders it impossible for wearers to contract chills and cold owing to great and sudden changes in the temperature in warm and tropical climates, and its suitability for the manufacture of military uniforms has often been alluded to. In

regard to this, it may be stated that during the recent war in South Africa, clothing made of ramie, principally tunics, was worn by a few of the troopers in one of the Imperial Yeomanry detachments in place of khaki, and was found to outlast it in wear, and to stand wet and washing much better. In some instances, notably recently in the United States, khaki cloth has been found very unsatisfactory for uniforms, having exactly the opposite tendencies to ramie in regard to moisture and perspiration during hot weather.

As giving some idea of the prices charged for the yarns, the following were quoted some little time ago by a firm who spun the fibre at Selby, in Yorkshire, Messrs. Foster and Co., on the worsted scale :—

1/12's Bleached Ramie Yarn, F2 quality,	2s. 0½d. per lb.
1/16's " " " "	2s. 1d. "
1/20's " " " "	2s. 1½d. "
1/24's " " " "	2s. 2d. "
1/32's " " " "	2s. 2½d. "
1/36's " " " "	2s. 3½d. "

Folded 1s. 2d. per pound extra.

Gossamer cloths made from ramie look exceptionally well, and should have a ready and profitable sale. Made into these light cloths the fibre has stood a breaking chain of 500lb. to the square inch.

Produced in the form of wool by carding the fibre felts, it can be used for many purposes. Cheap processes for treating it on the field where it is grown, so that it may be later carded, are the subject matter of recent patents, and this class of ramie is much cheaper than natural wool.

With many of the high-priced cottons ramie can easily enter into profitable competition, the cloths produced being not only cheaper, but stronger.

It has been stated by those who have investigated the possible demand for the raw product that under favourable conditions Great Britain alone could consume one thousand tons of this per month.

The fibre can be cheaply manufactured into waterproof cloths with little or no cloth waste, the same cleaning readily by passing a damp cloth over them. These cloths are very strong.

Suitably dyed ramie cloths would, no doubt, find an extensive and profitable sale in many of those Eastern and African native States to which silk materials are so largely shipped from this country at the present time, and be considerably cheaper.

The undernoted quotations were given recently for the yarns by a French filature :—

Nos.	Quality.	Singles.		Doubles.		
		Weft.	Warp.	Twist- ed.	Tight Twist.	Extra T'tT'st
		f.	f.	f.	f.	f.
7's	L.B.	—	—	—	—	—
8's	"	—	—	3.78	3.82	3.86
9's	"	—	—	3.82	3.86	3.91
10's	"	—	—	3.86	3.91	3.96
11's	E.G.	—	3.75	3.89	3.95	4.01
12's	"	—	3.79	3.93	4.09	4.05
16's	"	3.91	3.99	4.11	4.19	4.27
18's	"	4.03	4.12	4.23	4.32	4.41
20's	"	4.15	4.25	4.35	4.45	4.55
22's	E.F.	4.27	4.38	4.49	4.60	4.71
23's	"	4.33	4.44	4.55	4.67	4.78
24's	"	4.39	4.51	4.63	4.75	4.87
25's	"	4.45	4.57	4.70	4.83	4.95
26's	"	4.51	4.64	4.77	4.90	5.03
27's	"	4.57	4.70	4.84	4.98	5.10
28's	"	4.63	4.77	4.91	5.05	5.19
30's	"	4.75	4.90	5.05	5.20	5.35
32's	1a.	4.83	4.98	5.14	5.30	5.45
34's	"	5.09	5.26	5.43	5.60	5.77
36's	"	5.29	5.47	5.65	5.83	6.01
38's	"	5.51	5.70	5.89	6.08	6.27
40's	"	5.75	5.95	6.15	6.35	6.55
45's	"	6.47	6.69	6.92	7.13	7.35
50's	"	7.31	7.56	7.81	8.06	8.31
55's	Extra	8.21	8.48	8.76	9.01	9.29
60's	"	9.20	9.50	9.80	10.10	10.40
65's	"	10.21	10.53	10.86	11.18	11.50
70's	"	11.30	11.65	12.03	12.35	12.70

The number of ramie threads represents the number of times 1,000 metres of yarn is contained in one kilogramme, and the prices are for 1 kilogramme, and in francs. The numbers in ramie being metric, to correspond in length with cotton or linen, these must be multiplied by the number of metres to the kilogramme—that is to say, for linen, the number 605; for French cotton, 2,000; for English cotton, 1,695. Thus, No. 20's linen multiplied by 2,000 equals No. 60's ramie; No. 30's English cotton multiplied by 1,695 equals No. 50⁸⁸ ramie, and in order to have the connection in size it is necessary, on account of the density difference, to add for linen 10% to the number of ramie found, and for cotton reduce by $\frac{1}{4}$ the number of ramie found. Thus, in order to have in ramie the correspondence to 20's linen, it is necessary to add 10% to the number 12¹⁰, which gives exactly 13¹⁰; likewise 30's cotton reduce the No. 60's by $\frac{1}{4}$, which gives exactly 45. To transform in length the numbers of ramie and the numbers of English linen, it is necessary to multiply the number of ramie by 1.66, or divide by 0.60; in English cotton multiply by 0.60, or divide by 0.166; in French cotton multiply by 0.50, or divide by 0.02; so states the quotation list. So far as prices asked for ramie silk yarns are concerned, and which run to much higher counts than these, as giving some idea it may be said that if the current price of 2/60's all silk were 10s. per pound, 2/60's ramie silk would be 5s. 6d. per pound, for the very finest quality of yarn, to compete with it, and the difference in the cost of the two materials runs at about this average through all counts spun.

The yarns might be extensively used for weaving repp cloths, and the commoner qualities for engine packing. The fibre combines the entire range of applications of hemp, the entire range of the uses of flax, and other uses for which animal fibres only, silk and wool, have hitherto been employed. Reductions in the cost of raw supplies will naturally reduce these quotations.

CHAPTER XV.

**How to Manufacture Rhea, or Ramie, Fibre
and China Grass Profitably.**

It is well known that from the time when ramie, or rhea, fibre first attracted attention up to the present the prospect of its being manufactured at very considerable profit has been the great incentive to all efforts to perfect the methods of its manufacture, and generally to study the different phases which the problem of its most profitable commercial utilisation presents. Naturally, the cheaper the degummed filasse can be produced the greater is the prospect of extensive outlets being secured for it when spun into yarn, or woven into the different descriptions of materials for which it is suitable. A low cost of production would open at once many lines of trade to the fibre for which at the present time other textiles are employed, but for which ramie, or rhea, by reason of its peculiar characteristics, would prove far more suitable, and so it is urged by very many that not only the process of decortication but also that of degumming should be carried out on the spot where the plant is grown. Freshly decorticated, the gums which impregnate the fibres would not then have solidified to the same extent as that to which they do when the decorticated fibre is not degummed until it reaches the European or American factory, and so the treatment of the product chemically would be easier, cheaper, and attended with less danger of damaging the fibre's valuable qualities. The fibre is to some extent in demand for certain purposes which do not require it to be degummed. The producer in this manner would of course have to know his customers' needs, and retain a portion of his crop undegummed for those who want the product in this state. A further saving would be effected by it being possible under these circumstances to make use of native labour very largely, which would in cost be far cheaper than wages paid for similar work in Europe, the United States, and certain

other countries, and there does not seem to be any reason to doubt that the Eastern native would be able to fulfil the duties required of him in quite as satisfactory a manner. Negro labour might be used in the Southern States of America. A further economy would be effected in freightage and insurance, as only the useful material would have to be paid upon. This is most decidedly the system to proceed upon in order to secure cheap production, and the ramie spinner, if he so wished, might have his own plantation, being so sure at all times of his raw supplies at a rate for growing, decorticating, and shipping to his mill, which could only vary as the annual crop varied in conformity with the particular climatic and other conditions of each season's growth.

Mr. B. Coventry says in regard to the suggestion made some little time ago that the fibre-yielding capabilities of Assam might be definitely ascertained were the Government of India to purchase and reap the crops of a few of the native cultivators, it would be necessary for the Government, or whoever attempted to solve the matter in this way, to take into consideration the time a crop takes to come to maturity before a profitable result can be obtained, the number of cuttings obtained in one year, and the number of years that a crop will continue to give profitable returns before it can be rejected. If the yield on decortication by the Faure or any other machine can be increased by better machinery, or the price of ramie is raised, or both, naturally the situation will be eased, and growing in India will extend; and he thinks that at £30 per ton for decorticated fibre, or even £40, it would be underselling flax. In his opinion it is intrinsically better than the flax fibre. If the yield of present decorticating machinery is increased it will pay the Indian planter to cultivate it in preference to other field crops, as the effect of this would be the same as the price of the product being raised. Improvements in existing and new decorticators, therefore, call for special notice, and in his judgment it is likely that in Assam crop competition

K

will not exist to the extent that it does in other parts of India.

So far as mill operations are concerned, some firms have deemed it best to degum and comb the fibre and offer it to the trade and spinners generally in the form of a sliver. Some have carried their operations a little further, and sell it in the form of rovings. The majority, however, offer their yarns for sale to weavers.

It cannot be too strongly impressed upon spinners who have the necessary machinery in their mills to work ramie that they should buy their filasse for spinning only from the degumming firms which produce, not only the cheapest fibre, but that which is the finest, strongest, and most silky, and which spins with the least trouble in regard to breakages, knots, and tangles. They should buy and test the degummed filasse produced by several of these firms before definitely placing large orders with any of them. Mill operatives do not like to work upon a badly degummed fibre, as they cannot make full wages spinning it, which is a source of additional trouble to the spinner.

Remunerative prices cannot with certainty be depended upon when the product is offered in the form of sliver, or rovings, unless the buyers are willing to go to the expense of providing themselves with the machinery requisite to carry out the further processes up to and including spinning in a proper manner. Accordingly it is advisable that parties embarking in the trade should spin the yarns themselves, and if by any means they can be assured of a remunerative market for cloth, it might be of a special description, or descriptions, by reason of their trade connections or other circumstances, then to spinning they may with advantage add weaving. With respect to dyeing, printing, and finishing, these processes can be most satisfactorily carried out by firms who make a speciality of them, and the risk of heavy loss in the trade of spinning and weaving rhea, or ramie, by reason of mistakes being made in connection with these operations—and it is a well-known fact that dyers, printers, and finishers suffer heavily by technical errors from time to time—is obviated.

There are authorities, however, who maintain that in starting factories for the manufacture of ramie they ought, wherever possible, to be self-contained. In other words, the manufacturing operations should include all processes from the raw material to the finished article ready for sale to the consumer. In this manner the manufacturer would have full control over all the operations, even the apparently least important, and in this way is not running the danger of failure through the ignorance or incapacity of others. This method of working the fibre is one which would necessarily require the expenditure of a very considerable amount of capital, and so far as the processes of dyeing, printing, and finishing—not only ramie, but other textiles—are concerned, it may be borne in mind that firms who are in these trades are, by business customs and law, bound to carry out all orders given to them by outsiders according to sample, or pay compensation claims. The author therefore holds the view that in those instances in which substantial capital is invested in rhea, or ramie, enterprises, with a view to manufacturing this new fibre (for it may justly be called new, since it is only within the last few years that its peculiar characteristics, needs, and requirements have become known, as well as its distinctive varieties) at a substantial profit, it would prove the wisest course to utilise any surplus capital in the way of the manufacturer being also the grower. Except careful arrangements or contracts are made beforehand, it is not safe to establish mills, as has been done in years gone by, and trust complacently for adequate supplies of ribbons or decorticated fibre at low prices from India and other British possessions. Parties having business connections in China can, no doubt, readily make contracts, and now at fairly steady forward prices for supplies of China grass; but then this product commands a higher price than rhea, or ramie, from elsewhere, and the spinner and manufacturer of the fibre cannot get the same profit when dealing with it as when, all technical conditions being favourable, he spins the Indian, or fibre imported from other countries than China.

In regard to the establishment of an Indian rhea, or ramie, growing industry, the question of obtaining adequate raw supplies at a moderate price for the use of European and American mills generally would likely be settled were central decorticating stations, supplied with the Faure or some other suitable decorticator, established in Jalpaiguri and the Duars after ramie-growing trials, or in such other districts as Sir George Watt has specially recommended. The plant could be then cultivated around these stations by the Europeans by whom they were established, and there seems also every probability that the natives in the district, who already grow it fairly extensively, being relieved of the trouble of separating the fibre, would at once commence to cultivate it on a very much larger scale, and bring their stems in to these stations, and dispose of them at a fairly cheap rate for decortication and shipment to manufacturing centres. It has repeatedly been urged that it is the trouble of separating the fibre which prevents it being cultivated far more widely, and under such a system as the one suggested this obstacle would cease to exist. It would be easy found money for the native to plant small plots, and giving the plant such care as it requires cut the stems as they matured, and sell them to the decorticators. Such stations should be established in close proximity to the native villages in which the plant is grown to-day, and, as before stated, they could not only decorticate, but cultivate to a moderate extent themselves also. This is the only solution of the problem of raw supplies on a commercial basis, although far more material is now to be obtained from sources other than China than was the case even four years ago, save the securing by Europeans of concessions of land upon which to cultivate the plant in China; and its decortication being carried out on the spot by either machine or hand methods whichever they deemed best. Labour is about the same in regard to wages in China as in India.

In conclusion, it may be observed that if the operator of a good degumming process, and owner of a mill for preparing and spinning ramie and China grass, locates

and enters into correspondence with planters in countries in which, while ramie can be successfully cultivated, there is not such a choice of other highly remunerative field crops as to cause them to neglect ramie culture on account of its lesser profits, and there are many such, there is no reason why he should not be able at all times to obtain ample raw supplies, either in the form of ramie ribbons or some other condition, and do a very profitable business, but his degumming must be perfect, and his preparing and spinning machinery such as will produce a good yarn without undue waste, in other words economically.

CHAPTER XVI.

Ramie Cultivation in China, and the Chinese Grass Cloth Industry.

BOEHMERIA NIVEA, Hook, et, Arn, rhea, or ramie, whose fibre furnishes the grass cloth which is manufactured in China, is produced in large quantities in Central, Western and Southern China, especially in the Valley of the Yangtsze. The production and the area of cultivation are extending. The provinces in the Yangtsze are the great centres of production, and there is an average annual export from Ssuch'nan to Hankow of more than 40,000 piculs, or 47,619cwt. Hankow also draws from Hupei and Hunan 120,000 piculs, or 143,095cwt. per annum. For the five years following the total export of ramie from Hankow, exclusive of the receipts from Ssuch'nan, was as under :—

1901	Quantity in Cwt,	124,988
1902	do.	139,881
1903	do.	145,833
1904	do.	153,332
1905	do.	185,714

The average annual export abroad is about 97,500 piculs, which is almost 65 per cent. of the total yield, and the price at Hankow of white China grass (ramie), *B. nivea*, was in 1905 £1 5s. 5 $\frac{2}{10}$ d. to £1 8s. 1 $\frac{6}{10}$ d. per

cwt. The Ssuch'nan product is always known by the name of Green China Grass (this is *B. tenacissima*), and it was then quoted £1 11s. 2 $\frac{1}{10}$ d. per cwt., which is higher, it will be seen, than that of the other quality.

All the so-named hemp which is exported from Kiukiang, the next port below Hankow, is ramie fibre in reality. It comes principally from the province of Hupei, and the under-noted figures give the weight and value of this for the years 1901 to 1905:—

Year	Quantity. Cwt.	Value. £
1901	116,294	114,164
1902	103,582	129,959
1903	79,762	107,099
1904	99,764	132,032
1905	135,279	192,986

—calculated at the rates of exchange then ruling.

The British Consul at Kinkiang states that the falling off in the export during 1903 and 1904 was possibly due to more of the raw material being exported in the shape of grass cloth, of which more than the average quantity was sent away.

From Kiukiang the ramie is exported mostly to Japan and Tientsin. In 1900 an experiment was made of exporting the product to Germany. This proved successful, and German firms continued to ship from Shanghai with the result that the export in 1901 was 20,605cwt., and the value £26,568 more than in 1900. This increased demand caused a rise in price from 10 or 11 to 13 or 14 taels per bale. Nearly all the buyers of ramie fibre, and the grass cloth which is manufactured from it, live in Shanghai. Two qualities of ramie are exported from the provinces in the Yangtze, the finer a product of Hunan principally, while the coarser comes from Anhui. The export of the Hunan product is now far more than double what it was a dozen years ago. About 20,000 packages, each weighing 70 catties (1 catty equals 1 $\frac{1}{3}$ lb.) are sent away from Chinkiang, the first port in the Yangtze, every year, making an annual export of 16,666cwt. The packages

are made up in the form of small neat bales, and are exported abroad largely to Japan. The coarser product of Anhui which is annually exported to the amount of 2,000 packages, each weighing 170 catties, a total approximating 4,047cwt., is packed loosely in large bundles for short transport. The returns which were received some little time ago from three ports on the Yangtze show an export of 19,666 tons, part of which is shipped abroad. Other provinces produce ramie, and when the returns from these are added to the above figures they have the effect of increasing them very greatly.

The cultivation of ramie *Boehmeria nivea* in China is owing to the plant's sensitiveness to cold restricted to the provinces which lie to the south of the 33rd parallel of latitude, and in the northern part of this extensive area the trenches which contain the rhizomes are covered in winter with ashes and manure as a protection from the frost.

For the years 1905 and 1906 the following were the Chinese Customs export returns for ramie:—

Year.	Quantity. Tons.	Value. £
1906	955	26,958
1907	5,133	160,155

But Sir Alexander Hosie, Acting Commercial Attaché to the British Legation at Peking, says he does not consider these figures of any value. Hemp, he states, is a term which in China is applied to all fibres, and he doubts very much whether true hemp (*Cannabis Sativa L*) is exported from China to any appreciable extent. Attempts are now being made to properly classify vegetable fibres, and it is admitted that probably all this so-called hemp exported from China is ramie. This is borne out by the values assigned to these fibres in the Customs returns. Judging by those given above, the spinning of Chinese ramie in Europe would seem to have increased fivefold in 1907 on the returns of the preceding year; as a matter of fact, there was an increase, as is partly proved by the larger

export of German ramie textiles in that year to the United States, and the opening of new mills, but there was certainly no such increase on the year as this.

The exports of hemp for those two years were given as :—

Year.	Quantity.	Value.
1906	11,206	£327,548
1907	7,784	207,213

and if the bulk, if not all, of the fibre called hemp exported from China is ramie, Sir Alex. Hosie says a nearer approximation to the actual export of the latter will be reached by adding together the figures for both fibres. This comes to 12,917 tons, having a value of £367,368, and it may be asked, Is this quantity of ramie available for export from China to foreign countries? The British Consul at Hankow gave 10,325 tons as the total export (though not necessarily abroad) of ramie from Hankow, and His Majesty's Consul at Kinkiang 7,088 tons of hemp (which is there well known to be ramie) some little time ago as the export from Kiukiang, or a total export from these two ports of 17,413 tons, so that there is no difficulty in making up the 12,917 tons here given. Japan is well-known to be the chief importer of ramie, and according to the Japanese trade returns 7,833 tons of China grass were imported from Central China in 1907, so that bearing in mind the admirable manner in which these and other trade returns are kept in Japan, and the great care which is exercised in classifying them correctly, it may be said without any hesitation that the figures for ramie (5,133 tons) given in the Chinese Customs Returns are far short of the actual export.

The price of cleaned ramie ribbons in China depends upon their length, because the grass cloth with which they are made is woven of hand-shredded yarn, and the fewer the joins the better the cloth. The ribbons obtained from the first and third crops are shorter, and therefore cheaper, than the ribbons obtained from the second crop, but if the manufacturer can obtain the same quantity of the ultimate fibres from the same

weight of shorter ribbons, why should he pay a high price for the longer, it is often asked.

The price in China for the best ribbons is never less than £24 to £25 per ton.

In 1905 the definitely ascertained export of ramie fibre from the three provinces of Ssuch'nan, Hupei, and Hunan was as under :—

Export from Ssuch'nan.....	47,619cwt.
" " Hankow	185,714cwt.
" " Kinkiang	135,279cwt.
" " Chinkiang	16,660cwt.
	<hr/>
Total	385,272cwt.

The British Consul at Ningpo gives the following figures as an approximate estimate of the production of ramie in the province of Chekiang for the years 1901 to 1905 :—

1901	2,560cwt.
1902	2,380cwt.
1903	2,140cwt.
1904	2,140cwt.
1905	1,190cwt.

It is sent by junk to Foochow and to Wemchow and other places on the seaboard of Chekiang. Though it has been stated that ramie is only grown in the Hsiangshan district of Chekiang, this is not correct, as English residents in China have seen it largely grown in the neighbourhood of Wanchow, and it was cultivated there in 1896.

The British Consul at Wuchow places the out-turn of the province of Kwangsi at 1,000 piculs, or 1,190cwt., and states that the bulk of it is consumed locally, the balance being sent by junk to the Canton Delta, whereas at the port of Kongmoon the finest grass cloth of China is manufactured.

The manufacturer who desires to buy Chinese ramie should go to Hankow and Kinkiang, the principal markets for the fibre. The export from Shanghai is

simply a re-export from the Yangtsze. The production of the Southern provinces is not enough for local needs, and has to be supplanted from the Yangtsze.

Grass cloth is not very well known in Great Britain, and the same remark applies largely to India. It is made both coarse and fine. It is an excellent material for ladies' summer skirts; it is thin, light, of great strength, and will stand any amount of washing; it naturally follows ramie from the hand-shredded fibres of which it is manufactured. The exports of this cloth from China rose from 10,075cwt. in 1904 to 15,600cwt. in 1905, and exceeded the average of the previous five years by nearly forty per cent. Its value was £189,463, but as the export is expressed in weight, and includes all descriptions made, this does not help us in endeavouring to arrive at the value of a piece. The best grass cloth which the province of Ssuch'nan produces can be purchased at $2\frac{1}{2}$ taels (equal to about 7s.) per piece measuring 51 feet by $19\frac{1}{2}$ inches British. A piece of Canton grass cloth, the finest in China, costs 20 dollars or more, and the length is some 70 Chinese feet, or about 28 British yards. This narrow width is not liked by the foreign milliner and tailor; seventeen inches is the usual width, but the best Canton grass cloth has lately been found to measure 20 yards by 34 inches.

The export of grass cloth fell in 1906 from 15,600 to 13,439cwt., and in value from £189,463 to £177,607, but the quantity exported in 1906 was 8.62 per cent. ahead of the previous five years average. Orders received from Great Britain have elicited the statement from British firms in Canton that unless something superfine is specially required a piece of the above measurements costs 27 dollars. In Shanghai various qualities of Canton grass cloth have been priced, ranging from 13.50 per piece to 26 dollars, but the very finest quality was stated by one retailer to cost as much as 50 dollars per piece, so he did not stock it. In 1907 the exports rose from 13,439 to 15,202cwt.

In a small room in a Chinese machine shop in Shanghai machine belting was a year or so ago discovered being

woven from ramie, the yarn used was coarse, the loom a primitive two-pedalled one; one man worked the pedals, another inserted the yarn, and the third drove it home with a wooden bar, and ramie belting was afterwards noticed on a driving wheel in another Chinese engineering establishment. It was stated to be giving every satisfaction. The belting was coated with white paint on the outside, and well oiled on the inside.

Samples of ramie filasse forwarded to Europe from Shanghai, where they were produced, were valued at 8 to 10 pence per lb. (c.i.f. London).

The following figures represent the export of fine and coarse grass cloth during the last five years :—

	Quantity.	Value.
1901	11,251cwt.	£53,165
1902	11,418cwt.	£55,094
1903	15,294cwt.	£86,345
1904	13,249cwt.	£101,048
1905	16,017cwt.	£130,160

In the year 1905 there was an unusual demand for the fibre and the cloth.

The export trade of Kinkiang is in the hands of natives who ship by foreign river steamers to Shanghai, and from thence the goods are carried to their destination. The agents of the Shanghai buyers of ramie and grass cloth are sent up country via Kinkiang and Wuhsuch, and they deliver their purchases over to the local shipping houses, who for a commission make the arrangements for its transport to Shanghai. The grass cloth is not manufactured in Kinkiang itself. A large amount of the fibre which reaches the port is despatched inland into the province of Kiangai, and comes back in the form of grass cloth for export.

Chinese grass cloth is not superior, if it is indeed equal, to the product of the looms of the best ramie mills in Europe and America—that is, those mills whose yarns are purchased from the firms working the best

processes for degumming the fibre, and who possess satisfactory machinery for preparing and spinning it; and at the same time the cloths cost more, so that there is not much reason to believe that the manufacture of grass cloth in China will seriously compete with the ramie and China grass mills now at work in the old and new worlds, either at the present time or in the future.

INDEX.

A.	PAGE
Area for Successful Ramie Culture	8
Assam Ramie Culture	3, 8
Algerian Ramie Culture	45
Andrewe Decorticator	79
Aquielles Decorticator	79
Assaying or Testing Ramie	86
B.	
Boehmeria Nivea	3
Boehmeria Tenacissima	4
Bon (Ban) Rhea or Riha	3, 5, 56
Burmese Ramie Culture	8, 32
Bengal Ramie Culture	8, 20, 23
Bogra Ramie Culture	21
C.	
China Grass	1
Culture of Ramie Generally	6, 12
Crops Obtainable	8
Cutting Ramie	24
Cleaning the Fibre	36
Cost of Growing Ramie	41
Culture of Ramie in Cape Colony	53
Culture of Ramie in British East and West Africa	53, 54
Chinese Ramie Factories	97, 98
China Grass Growing Areas	133
Chinese Grass Cloth Industry	138
Cost of Spinning Ramie	92
D.	
Description of the Ramie Plant	1
Discovery of Ramie	5
Drought and the Ramie	7
Dry Fibre Yield	10
Difficulties in Regard to Supply	10
Decorticating Bonus	13
Drainage	29
Decortication	65
Degumming Ramie	83, 106
Drawing of Ramie	89
Dyeing of Ramie	84, 101

E.	PAGE
Exhaustion of Soil.....	43
Egyptian Culture	48
Expansion of Indian Ramie Culture	54
F.	
Fibre of Ramie, Where Contained	4
Filament Length of Ramie	6
Fibre of Ramie, Description	5
Fineness of Fibres	49
Faure's Decorticator.....	67
Finishing Ramie.....	99
Foreign Flax, British Rise of	104
Filasse	35
G.	
Growth of Ramie	7
Gossamer Cloths Ramie.....	125
H.	
Habitat of Ramie	1
Hard Ends	89
Hosiery Manufacture from Ramie.....	113, 117, 124
How to Manufacture Ramie Profitably	128
I.	
Indian Plant	6
Indian Culture	8, 16
J.	
Jungle Land and Ramie Culture.....	8
K.	
Kankhura	2
Kangra Valley Culture	8
L.	
Lehmann's Decorticator	67
M.	
Merits of Ramie.....	4
Manure.....	38
N.	
Native Method for Obtaining the Fibre	21
North West Indian Ramie Culture	43
Nigerian Ramie Culture	54
Native Labour on Ramie Plantations.....	31

	PAGE
O.	
Oudh Ramie Culture	43
P.	
Propagation of Ramie from Seed	9
Punjab Culture	8
Propagation from Cuttings	37
Propagation from Roots	37
Planting	15
Preparation of Ramie Ribbons for the Market	80
Plantations, Laying out of	23, 84
Preparing and Combing Ramie Filasse	87
Printing Ramie	123
Prices of Ramie Yarns	107, 125, 126
Possible Demand for Ramie	125
Plantation Degumming	128, 129
Q.	
Queensland Ramie Culture	54
R.	
Rainfall Needful for Ramie Culture	7
Ramie and Dundee	12, 13
Ramie and Tobacco Lands	20
Rungpur and District Culture	21
Ramie Ribbons	27
Reading Ramie Plantation	34
Ramie Noil	90, 98, 109, 123
Ramie Yarn	86
Roving Ramie	89
Ramie in Great Britain	101
Ramie in France	108
Ramie in Germany	110
Ramie in Switzerland	112
Ramie in the United States	114
Ramie in South Africa	119
Ramie Wool	125
Ramie Raw Supplies	132
Ramie Culture in China	133
Ram Bagh Plantation	36
S.	
Soil Requisite for Ramie Culture	7
Straits Settlements Ramie Culture	9
Shawls, Riha	11
Strength of Ramie	12
Spools for Seeding	37
Spinning of Ramie	91
Shading	47
Suitable Areas for Culture of Ramie	15, 20
Schlichten Decorticator for Ramie	79
Sliver of Ramie	103

	PAGE
T.	
Transplanting Ramie	23, 25
U.	
Use of Ramie for Hedges	10
Uses of Ramie Yarn	121
V	
Varieties of Ramie	1, 5, 6
Vernacular Names of the Plant.....	2
W.	
Weaving of Ramie	11, 90, 99
White Ants.....	22
Weeding, Hoeing of Ramie Fields	24
Wynaad Ramie Culture.....	32
Water in Green Ramie Stems	34
Y.	
Yields of Fibre	30, 33, 40, 41



THE TECHNICAL PUBLISHING CO'S

STANDARD
TECHNICAL BOOKS

. . . FOR . . .

ENGINEERS,
MECHANICS,
DRAUGHTSMEN,
SCIENCE STUDENTS,
&c., &c.

Any book included in this List will be supplied through the post to any address at home or abroad on receipt of published price, together with postage



LONDON :
THE TECHNICAL PUBLISHING Co. LTD.
55-56, CHANCERY LANE, W.C.

“ THE PRACTICAL ENGINEER ”

POCKET-BOOK AND DIARY.

PUBLISHED ANNUALLY.

Price 1s. net; Leather Gilt, 1s. 6d. net. Postage 3d.

CONTAINING 700 PAGES OF INFORMATION ON

Steam Boilers	Entropy	Screw Threads
Boiler Seatings	Mechanical Efficiency of	Cranes and Hooks
Chimneys	Engines	Roller and Ball Bearings
Fuels	Valve Diagrams	Momentum and Inertia
Mechanical Stokers	Governors	Cast-iron Pipes
Feed Pumps	Springs	Notes on Mining
Heaters and Economisers	Engine Testing	Reinforced Concrete
Condensers	Gas and Oil Engines	Metals, Alloys
Cooling Towers	Pressure and Suction	Refuse Destroyers
Steam Engines	Gas Producers	Photo Copying
Steam & Water Turbines	Refrigerators	Liquid Fuel Appliances
Water Purification	Hydraulics	Heavy Motor Vehicles
Properties of Saturated	Ventilation and Heating	Tractive Forces
Steam	Wheel Gearing	Motor Car Act
Superheated Steam	Belt and Rope Driving	Notes on Patents and
Indicator Diagrams	Wire Ropes	Patent Law
Piston Constants	Cutting Tools	Numerous Tables, &c.

“ THE PRACTICAL ENGINEER ”

ELECTRICAL

POCKET-BOOK AND DIARY.

PUBLISHED ANNUALLY.

Price 1s. net; Leather Gilt, 1s. 6d. net. Postage 2½d.

CONTAINING 500 PAGES OF INFORMATION ON

Arc Lamps	B. of T. Regulations for	Power Required for
Incandescent Lamps	Electric Lighting	Driving Shafts and
Direct-coupled Generators	Electric Lifts and Cranes	Machine Tools
Power Gas	Patents and Patent Law	Methods of Measurements
Magnetism	English Standards of	of Currents
Electrolysis	Weights and Measures	Accumulators and Primary
Electric Mining	Railways and Light	Batteries
Electrical Units	Railways	Formulae for Magnetic
Electric Fittings	Electric Traction	Calculations
Dust Destroyers	Potential Resistance	Design of Dynamos,
Electric Welding	Working Hydraulic and	Alternators, and
Electric Lighting	Electric Lifts	Transformers
Rules for Wiring	Modes of Transmission	Electrical Transmission &
Rules for Installations	by Belts, Ropes and	Power in Factories
Electric Lighting Acts.	Gearing	Numerous Rules, Tables,
	Conduit System of Wiring	&c., &c., &c.

THE TECHNICAL PUBLISHING CO. LTD.

55-56, CHANCERY LANE, LONDON, W.C.

LIST OF STANDARD
TECHNICAL BOOKS

FOR

Engineers, Mechanics, Science Students, Etc.

PUBLISHED BY

THE TECHNICAL PUBLISHING CO. LTD.

55-56 CHANCERY LANE, LONDON, W.C.

WORKSHOP COSTS (for Engineers and Manufacturers). By SINCLAIR PEARN and FRANK PEARN (Directors of Messrs. Frank Pearn and Co. Ltd., West Gorton Ironworks, Manchester), with a Preface by G. Croydon Marks, M.P., Assoc. Memb. Inst. C.E., M.I.M.E., &c. Second Edition, post folio, bound in roan, with numerous Specimen Workshop Cost Forms, price 12s. 6d. net, post free 13s.

"It is not often that such an elaborate work, and one of which the utility is undoubted, is placed at the disposal of the public interested in such questions at a price which certainly is insufficient to repay the cost of publication."—*The Times Engineering Supplement*.

"To Managers and those interested in the control of engineering works the book affords a striking object lesson as to what can be done in the way of cost-keeping."—*Textile Recorder*.

"After a careful perusal of the notes and examination of the examples given, we are able fully to endorse the authors' claims as to the reliability of the system."—*British Trade Journal*.

"This is a book which ought to find a place in the offices of every workshop."—*Page's Magazine*.

"Manufacturers and engineers whose work lies in this department will find the book invaluable."—*The Steamship*.

THE MANAGEMENT OF SMALL ENGINEERING WORKSHOPS. By ARTHUR H. BARKER, B.A., B.Sc., Wh.Sc., &c., Author of "Graphical Calculus," "Graphic Methods of Engine Design," &c. Crown 8vo, cloth, price 7s. 6d. net, post free 7s. 11d.

"We may congratulate Mr. Barker upon this book. . . . The treatment of the subject is extremely satisfactory."—*Textile Recorder*.

"There is much sound advice in this work, and the proprietors of small shops, as well as their managers, may derive much benefit from a perusal of its pages."—*English Mechanic*.

"May be conscientiously recommended as containing much sound advice on a matter of the highest importance in connection with manufacturing operations."—*Journal of Gas Lighting*.

"As a generally suggestive scheme for the efficient control of small engineering workshops, we would certainly commend Mr. Barker's book, while those in charge of larger concerns may profit not a little by perusing it."—*Mechanical World*.

ENGINEERING ESTIMATES AND COST ACCOUNTS. By F. G. BURTON, formerly Manager of the Milford Haven Shipbuilding and Engineering Company Limited. Second Edition. Crown 8vo, cloth, price 3s. net, post free anywhere 3s. 3d.

"Contains many useful hints and valuable information."—*The Builder*.
 "To all who have to do with engineering estimates and cost accounts, this treatise should prove eminently useful. It is to be heartily commended to the notice of managers, foremen, and draughtsmen."—*Steamship*.
 "The author has undoubtedly a thorough grasp of his subject. . . . We have formed a high opinion of the work. It is, perhaps, the best book of its kind and price in the market, and has our hearty commendation."—*Science and Art of Mining*.

THE INDICATOR AND ITS DIAGRAMS:
 WITH CHAPTERS ON ENGINE AND BOILER TESTING. By CHARLES DAY, Wh.Sc. Including a Table of Piston Constants. This book is of a thoroughly practical character, and contains numerous diagrams from actual practice. Third Edition. Crown 8vo, cloth, price 4s. 6d. net, post free anywhere 4s. 10d.

"The book is one of the most useful we have met with."—*Mechanical World*.
 "A really excellent book, which we have pleasure in recommending."—*Electricity*.
 "The book is notable for its lucid explanations. There is scarcely a point left untouched."—*Textile Recorder*.
 "We have not the slightest doubt this useful little work will be thoroughly appreciated by all who peruse it."—*Machinery*.
 "The second portion of the book contains a vast amount of valuable information, which should secure a large sale for the book. . . . It is well worth a place on the shelves of all progressive engineers, and scientific men generally."—*Age of Steel*.

PRACTICAL NOTES ON THE CONSTRUCTION OF CRANES AND LIFTING MACHINERY. By EDWARD C. R. MARKS, Assoc.M.Inst.C.E., M.I.Mech.E. New and Enlarged Edition. Crown 8vo, cloth, price 3s. 6d. net, post free anywhere 3s. 10d.

"We can heartily recommend this book to all enquirers and students interested in the subject."—*Model Engineer*.
 "The book is to be recommended as the best on the subject, and will be found of the greatest service to all who have to use or design lifting machinery."—*The Steamship*.
 "The author of this book has had splendid facilities for becoming practically acquainted with the subject upon which he writes. . . . The book is admirably illustrated throughout, and is a most useful addition to the literature on this subject."—*Engineering Times*.
 "This excellent work on the modern crane and other lifting machinery has reached a third edition. . . . The advance made during the last few years in the application of hydraulic and electric power to work of this description, is so important that the new and enlarged edition was fully warranted."—*British Trade Journal*.

NOTES ON THE CONSTRUCTION AND WORKING OF PUMPS. By EDWARD C. R. MARKS, Assoc.M.Inst.C.E., M.I.M.E., &c. Second Edition. Crown 8vo, 260 pages, price 4s. 6d., post free 4s. 10d.

"A convenient and useful book of reference."—*The Builder*.
 "Should enable engineers and manufacturers to select the apparatus best suited to their requirements."—*Mechanical World*.
 "The book is one which may be recommended to all who are interested in the field of engineering work."—*Marine Engineering*.
 "Purchasers of pumps will find a collection of information in this volume which may save them much trouble."—*Page's Magazine*.

CENTRIFUGAL PUMPS, TURBINES, AND WATER MOTORS: including the Theory and Practice of Hydraulics (specially adapted for Engineers). By CHAS. H. INNES, M.A., Lecturer on Engineering, at the Rutherford College, Newcastle-on-Tyne. Fourth Edition, enlarged. Crown 8vo, price 4s. 6d net, post free anywhere 4s. 10d.

"This extremely useful work, in its fourth edition, has received further additions, notably an extra chapter on centrifugal pumps and fans for high lifts and pressures."—*Model Engineer*.
 "The fourth and enlarged edition of an admirably-written book on the centrifugal pump, &c."—*British Trade Journal*.
 "Those who have wanted a simple treatment of the theory and design of Centrifugal Pumps and Turbines will welcome this book, and we can recommend it."—*The Engineer*.
 "To most of our readers this book must be favourably known. We have, on many occasions, recommended it to inquirers as the best book on the subject in English, at a reasonable price."—*American Machinist*.

HEAT AND HEAT ENGINES. A Treatise on Thermo-dynamics, as Practically Applied to Heat Motors. Specially written for Engineers. By W. C. POPPLEWELL, M.Sc. Crown 8vo, cloth, price 6s. net, post free anywhere 6s. 5d.

"The volume is one which we have pleasure in commending to the attention of those engineers who wish to gain a clear conception of the elementary laws of the heat engine."—*The Engineer*.

PROBLEMS IN MACHINE DESIGN. For the use of Students, Draughtsmen, and others. By C. H. INNES, M.A., Lecturer on Engineering at the Rutherford College, Newcastle-on-Tyne. Second Edition. Crown 8vo, cloth, price 4s. 6d. net, post free anywhere 4s. 10d.

"Of much value to draughtsmen and engineers, to whom we cordially recommend it."—*Mechanical World*.
 "That the book will be valuable to many there can be no doubt, and it is to be cordially recommended to the notice of engineering students."—*Steamship*.

THE APPLICATION OF GRAPHIC METHODS TO THE DESIGN OF STRUCTURES. Profusely illustrated. A Treatment by Graphic Methods of the Forces and Principles necessary for consideration in the Design of Engineering Structures, Roofs, Bridges, Trusses, Framed Structures, Walls, Dams, Chimneys, and Masonry Structures. By W. W. F. PULLEN, Wh.Sc., A.M.Inst.C.E., M.I.Mech.E. Second Edition. Crown 8vo, cloth, price 5s. net, post free 5s. 4d.

"Engineers generally will find this work of much value."—*Steamship*.
 "It has established its reputation as a handbook of value for engineers."—*Daily Telegraph*.
 "Written by an expert, . . . for experts, this manual should prove of much usefulness to all classes of engineers."—*The Scotsman*.
 "The fact that a second edition of this work has been called for is evidence of its increasing popularity. . . . As a work exclusively devoted to graphic statics, this treatise is the best of its class. . . . Our advice is, get it."—*Canadian Engineer*.

MODERN GAS AND OIL ENGINES. Profusely illustrated. A full and exhaustive Treatment of the Design, Construction, and Working of Gas and Oil Engines up to date. By FREDERICK GROVER, Assoc.M.Inst.C.E. Fifth new and enlarged Edition. Crown 8vo, cloth, price 5s. net, post free 5s. 4d.

"It is clear that those interested in gas and oil engines have recognised the usefulness of this work."—*The Ironmonger*.
 "This fresh matter comes as a welcome addition to a work whose value is already appreciated by practical engineers."—*The Builder*.
 "In its revised form it should meet with the increased appreciation of draughtsmen and others interested in the design and operation of gas and oil engines."—*Mechanical World*.
 "'Modern Gas and Oil Engines' is an almost ideal text book on the important subjects which occupy its pages. It is no reflection upon other eminent men who have written, and written with great ability, to say that Mr. Grover's work surpasses them all in its concise, lucid, and thorough practical line of exposition."—*Science and Art of Mining*.

THE RESISTANCE AND POWER OF STEAMSHIPS. By W. H. ATHERTON, M.Sc., and A. L. MELLANBY, M.Sc. Price 5s. net, post free 5s. 4d.

"The book will appeal to marine engineers and shipbuilders, and, in fact, to all who are interested in watching the development of steamships."—*Scientific American*.
 "The book merits a place as a standard aid to the marine engineer and shipbuilder."—*The Steamship*.
 "One of the admirable series of text books published by the Technical Publishing Co. Ltd. . . . The authors are to be congratulated."—*British Trade Journal*.

MARINE ENGINEERS: THEIR QUALIFICATIONS AND DUTIES. With Notes on the Care and Management of Marine Engines, Boilers, Machinery, &c. By E. CONSTANTINE, Assoc.M.Inst.C.E., M.I.Mech.E. Second Edition. Crown 8vo, cloth, price 5s. net, post free 5s. 4d.

"It is a masterly book of instruction, and the author can be congratulated upon having produced a really useful and serviceable manual."—*Western Mail*.
 "We record with pleasure the advent of the second edition of this both useful and interesting book."—*The Model Engineer*.
 "We recommend this book to all who desire to become sea-going engineers."—*The Steamship*.

THE NAVAL ENGINEER AND THE COMMAND OF THE SEA. By FRANCIS G. BURTON, author of "Engineering Estimates and Cost Accounts," &c. Crown 8vo, cloth, price 2s. 6d. net, post free anywhere 2s. 9d.

"The story is written by one who has obviously carefully studied the subject, and knows what he is writing about."—*Naval and Military Record*.

AIR COMPRESSORS AND BLOWING ENGINES, specially adapted for Engineers, by CHAS. H. INNES, M.A., Lecturer on Engineering at Rutherford College, Newcastle-on-Tyne. Crown 8vo. Price 4s. 6d. net, post free 4s. 10d.

"One of the most useful handbooks on the subject we have yet seen."—*Mechanical World*.
 "Is by no means the least valuable of this thoroughly practical series."—*The Ironmonger*.
 "To all who wish to study and know about Air Compressors this book is invaluable."—*The Steamship*.
 "This book deals as thoroughly with the subject of Air Compressors as any work with which we are acquainted."—*Engineering Times*.
 "For those who can readily handle mathematics, the theoretical treatment of the subject is good."—*The Engineer*.

THE PROPORTIONS AND MOVEMENT OF SLIDE VALVES. By W. D. WANSBROUGH, author of "The ABC of the Differential Calculus," &c. Price 4s. 6d. net, post free 4s. 10d.

"For those who desire an intimate knowledge of the subject, the book is one of the best."—*Power*.
 "The book should prove a useful contribution to the literature of slide-valve problems."—*Marine Engineering*.
 "This publication will come as a boon to all who are in touch with, or controlling, engines of any class."—*Irish Engineering Review*.
 "Students, draughtsmen, and engineers generally, who are in search of a complete investigation of slide-valve problems, should find in Mr. Wansbrough's work a most-useful aid."—*Page's Magazine*.

CONTINUOUS CURRENT DYNAMOS AND MOTORS AND THEIR CONTROL. By W. R. KELSEY, B.Sc., A.I.E.E., F.Ph.S., Electrical Inspector under the Board of Trade to the Taunton Corporation. New and re-written Second Edition. Crown 8vo, cloth, price 7s. 6d. net, post free 7s. 10d.

"The book may be safely recommended to all who take a practical interest in continuous current machines."—*Model Engineer*.

"The book has many features which the practical designer and builder of dynamos and motors will appreciate."—*Mechanical World*.

"We can confidently recommend this book as a simply-written and thoroughly practical introduction to the study of continuous current machinery."—*Electrical Magazine*.

GOVERNORS AND GOVERNING MECHANISM. Second and Enlarged Edition. Crown 8vo. 120 Illustrations and folding plates. By R. H. HALL, Mech. Engineer. Price 4s net, post free 4s. 4d.

"A clever and comprehensive treatise."—*Page's Magazine*.

"This is an excellent book, and covers the field in a fairly comprehensive manner."—*Power*.

"May be heartily recommended to our readers as an excellent epitome of the subject."—*Model Engineer*.

"This useful little book will, no doubt, attract many readers amongst practical engineers."—*The Electrician*.

"A credit to the author, and to the press from which it is issued, and extremely useful to all engaged in engineering."—*Irish Engineering Review*.

THE MANUFACTURE OF IRON AND STEEL TUBES. By EDWARD C. R. MARKS, Assoc.M.Inst.C.E., &c., &c. Just Published. Second and Enlarged Edition. Crown 8vo, price 5s. net, post free 5s. 4d.

"A very serviceable little guide to a most important industry."—*The Surveyor*.

"The book should prove a useful handbook for manufacturers and others interested in the subject."—*Scientific American*.

"This is the second edition of a book of which we spoke in appreciative terms on its first appearance."—*Mechanical World*.

THE CHEMISTRY OF MATERIALS OF ENGINEERING. By A. HUMBOLDT SEXTON, Professor of Metallurgy, Glasgow and West of Scotland Technical College. Third Edition. Crown 8vo, price 5s. net, post free 5s. 4d.

"An interesting and very useful text book."—*Mechanical World*.

"An excellent book, we congratulate the author."—*Science and Art of Mining*.

"Not only a useful book for the beginner, but a convenient book of reference for the engineer."—*Railroad Gazette*.

"The book is one in which students of engineering will find much matter that is both interesting and useful."—*Glasgow Herald*.

THE A B C OF THE DIFFERENTIAL CALCULUS. By W. D. WANSBROUGH, author of "Portable Engines," "Proportions and Movement of Slide Valves," &c. Crown 8vo, cloth, price 3s. net, post free anywhere 3s. 3d.

"If any man can grasp the Calculus, the author of this little book should enable him to do so, for he has put the matter as clearly as it is possible to do."—*Cassier's Magazine*.

"The book is the clearest exposition by far of the fundamental theories of the Calculus we have seen. . . . Mr. Wansbrough's book is really entertaining; one smiles at its simplicity."—*The Engineer*.

"Having in view the character of the subject, the fact of a second edition being required is evidence that the attempt has been successful, and that the 'painless treatment for differential calculus' has at last been effected."—*Mechanical World*.

"We should recommend every student of mathematics who desires to thoroughly grasp the essential principles of the Calculus to make use of this well-named A B C. . . . We were beguiled into reading the work right through. . . . and are bound to admit that the difficulties of the Calculus seemed to disappear one after another."—*Page's Magazine*.

MACHINES AND TOOLS EMPLOYED IN THE WORKING OF SHEET METALS. By R. B. HODGSON, A.M.I.Mech.E., author of "Emery Grinding Machinery." Crown 8vo, cloth, price 4s. 6d. net, post free 4s. 10d.

"There is a scarcity of technical literature on Presses, Press Tools, &c. Mr. Hodgson's book will be welcomed by engineers and students desirous of gaining a better knowledge of theoretical and practical sheet metal working. . . . Those of our readers who are interested in the working of sheet metals will find Mr. Hodgson's book very interesting and useful."—*Iron and Steel Trades Journal*.

"A most valuable and helpful handbook on the subject. It covers a very wide range. The explanations are singularly clear and concise."—*Birmingham News*.

"The book gives a comprehensive and clearly written account of its subject, fully illustrated by plans and diagrams, and full of useful instruction."—*The Scotsman*.

"A book which should prove advantageous to both employers and workmen engaged in iron and engineering trades. . . . In consequence of its admirable treatment the book is one that will convey to the ordinary working man that which it would be exceedingly difficult for him to grasp in any other form."—*Wolverhampton Express and Star*.

MECHANICAL ENGINEERING MATERIALS.

By ED. C. R. MARKS, Assoc. M. Inst. C. E., M. I. Mech. E., &c., &c. Just Published. Second Edition. Price 2s. 6d. net, post free 2s. 9d.

"Mr. Marks is a practised author upon engineering subjects, and what he has to say he relates in a clear and concise fashion."—*Engineering Times*.

"This is undoubtedly the best book on this subject, and we have no hesitation in recommending it to all engineers and to those who are interested in this important subject."—*The Steamship*.

"Amongst the many treatises on the subject of metallurgy the small work before us is entitled to a prominent place."—*Irish Engineering Review*.

INJECTORS: THEORY, CONSTRUCTION, AND WORKING. By W. W. F. PULLEN, Wh. Sc., Assoc. M.Inst.C.E. Third Edition. Revised and Enlarged. Crown 8vo, cloth, price 3s. 6d. net, post free anywhere 3s. 9d.

"This is a capital little work, which may be recommended to all who wish to learn about injectors and ejectors. . . . It is, we think, the best work on injectors published."—*English Mechanic*.

THE THETA-PHI DIAGRAM. Practically Applied to Steam, Gas, Oil, and Air Engines. By HENRY A. GOLDING, Assoc. M.Inst.M.E. 3s. net, post free 3s. 4d.

"The most exhaustive and complete treatment upon the subject of entropy that we have seen."—*Machinery*.

"The work evidently supplies a void, as hitherto the information it gives was scattered about in the proceedings of technical societies. . . . The work is well timed, and should prove useful to a large circle of readers."—*Engineers' Gazette*.

"There can be no question of the importance to designers of steam engines of a careful study of the Theta-phi Diagram, and it must be conceded that Mr. Golding provides a work which renders this knowledge readily accessible."—*British Trade Journal*.

GRAPHIC METHODS OF ENGINE DESIGN.

By A. H. BARKER, B.A., Wh.Sc., author of "Graphical Calculus," &c. Second Edition. Crown 8vo, cloth, price 3s. 6d. net, post free 3s. 10d.

"Students of mechanics will find this book exceptionally interesting and useful."—*The Steamship*.

"This work bears evidence of great care in its preparation, and should prove useful to many young engineers."—*Engineers' Gazette*.

"The fact that this concise little work has entered upon its second edition, should be sufficient to indicate the value of the volume to the young mechanic."—*Page's Magazine*.

"This is a useful little work. . . . The mechanism of the steam engine affords a very complete series of illustrations. . . . The book gives a clear exposition of their application to practical work."—*Iron and Coal Trades Review*.

MODERN IRONFOUNDRY PRACTICE. Vol.

I: Foundry Equipment, Materials Used, and Processes Followed. By GEO. R. BALE, Assoc. M.Inst.C.E. Crown 8vo, 400pp, price 5s. net, post free 5s. 4d.

"To the practical man 'Modern Ironfoundry Practice' should prove a decided acquisition."—*Science and Art of Mining*.

"To the engineering student, draughtsman, young moulder and pattern maker, the volume would appear to be of inestimable value."—*Model Engineer*.

"A useful and up-to-date work on foundry practice. . . . The book is well balanced, and will be found a useful guide to modern practice in ironfounding."—*Mechanical World*.

MODERN IRONFOUNDRY PRACTICE. Vol. II: Machine Moulding and Moulding Machines, Physical Tests of Cast Iron, Methods of Cleaning Castings, &c., &c. By GEO. R. BALE, Assoc.M.Inst.C.E. Crown 8vo, price 3s. 6d. net, post free 3s. 10d.

"The machines illustrated and described are typical ones, besides which the reader will find a very exhaustive account of the physical tests of cast iron, which has now to be very thoroughly tested before being put into use."—*Scientific American*.

"This is the second and apparently concluding volume of an up-to-date and practical work on ironfounding, which we can recommend with confidence. . . . The chapter on testings is very complete, and taken altogether the complete work is a most satisfactory exposition of the science and art of ironfounding according to present-day practice."—*Mechanical World*.

SPECIFICATION FOR A LANCASHIRE BOILER (WORKING PRESSURE 200 LB.) By "INSPECTOR," M.I.M.E. Cloth, 2s. 6d. net, post free 2s. 8d.

"A book which we can well recommend to our readers' favourable notice."—*The Contractor*.

"In the hands of a prospective buyer of boilers this little brochure would help to solve many questions of a practical nature."—*The Ironmonger*.

"This work is one that all who deal with Lancashire boilers may take up with advantage if they desire information upon the boiler or its seating."—*Surveyor*.

SCREWS AND SCREW MAKING. Including an account of the origin of Whitworth's, Swiss, British Association, and American Threads, &c., with 95 Illustrations. Demy 8vo, cloth price 3s., post free anywhere 3s. 4d.

MODERN POWER GAS PRODUCER PRACTICE AND APPLICATIONS. By HORACE ALLEN. Price 6s. net, post free 6s. 5d.

"Should be of great practical value to those who are installing producer plant."—*Page's Weekly*.

"Will be a useful addition to an engineer's library."—*Times*.

"The book should be heartily welcomed by every one interested in the subject."—*Power*.

"It is a useful and up-to-date treatise on a subject of growing importance."—*Mechanical World*.

LOCUS IN MECHANICAL DRAWING. PART III. Piston Acceleration. By ALEXR. MACLAY, B.Sc., C.E., M.I.M.E., &c. Just Published. Demy 8vo, cloth, with numerous illustrations, price 2s. 6d. net, post free 2s. 9d.

"The comprehensive and clear treatment of this subject in the present work should at once make the book a standard of reference on this topic, and it should form a most acceptable addition to the working library of every draughtsman and designing engineer."—*Marine Engineering*.

HYDRAULIC POWER ENGINEERING. A

Practical Manual on the Concentration and Transmission of Power by Hydraulic Machinery. By G. CROYDON MARKS, M.P. Assoc.M.Inst.C.E., M.I.M.E., Fellow of the Chartered Institute of Patent Agents. Second Edition, Revised and Enlarged. Price 10s. 6d. net, post free 10s. 11d.

"Can be unhesitatingly recommended as a useful and up-to-date manual on hydraulic transmission and utilisation of power."—*Mechanical World*.

THE FAN: INCLUDING THE THEORY AND PRACTICE OF CENTRIFUGAL AND AXIAL FANS. By

CHARLES H. INNES, M.A., Lecturer on Engineering at Rutherford College, Newcastle-on-Tyne, author of "Centrifugal Pumps, Turbines, and Water Motors," and "Problems in Machine Design." Crown 8vo, cloth, price 4s. net, post free 4s. 4d.

"This book is one of a series of admirable text books issued by the same publishers."—*Mining Journal*.

"This book constitutes another valuable addition to the admirable series of text books on applied science."—*British Trade Journal*.

"The book probably contains all that can be usefully said of the fan, and is therefore to be warmly commended to all interested in the design and construction of such apparatus as from under the title adopted."—*Mechanical World*.

"This work is a complete mathematical treatment of the subject. . . . and is one of the best works on this particular subject we have yet reviewed."—*Power*.

"To the mining engineer and to others well versed in mathematics this book will appeal with a special interest."—*Iron and Coal Trades Review*.

INVENTIONS, PATENTS, AND DESIGNS.

With notes and the full text of the new British Patents and Designs Acts of 1907 and 1908. By G. CROYDON MARKS, M.P. Crown 8vo, 128 pages. Second and Popular Edition (revised and enlarged), bound in flush cloth 1s. net, post free 1s. 3d. In full cloth, gilt lettering, price 2s., post free 2s. 3d.

" . . . The author gives a short but clear summary of the nature of Letters Patent, and an outline of the simpler legal points with which the inexperienced inventor should be acquainted before applying for a patent. . . . The advantages of provisional protection are well brought out, and the chapter on licensing inventions, which shows careful selection, is especially worth the attention of an intending lessor."—*The Times*.

"The information given throughout the book is most useful to persons unfamiliar with matters concerning patents."—*The Engineer*.

SAND AND CLAY: Their Analysis and Physical Properties. By A. C. PASSMORE. Price 2s. net, post free 2s. 2d.

"The work serves its purpose admirably, and in many cases it will prove a handy book of reference."—*Estates Gazette*.

"It offers a plain and practical statement of the analysis and physical properties of sand and clay in their relation to building work."—*Building World*.

MODERN STEAM TRAPS (English and American).

By G. STEWART. Enlarged Edition. Price 3s. net, post free 3s. 3d.

"Supplies a long-felt want."—*Cassier's Magazine*.

"This little book may be commended as a handy guide to users of steam traps."—*Mechanical World*.

"All who have to deal with steam traps should have a copy of this very useful handbook."—*Steamship*.

HOW TO USE WATER POWER. By HERBERT CHATLEY, B.Sc. Price 2s. 6d., post free 2s. 8d.

"The author of this little book gives a succinct account of the principles of hydraulic engineering in an easily comprehensible form."—*Mechanical World*.

"For brevity, simplicity, and clearness this is one of the best little books we have seen, and we recommend it to readers interested in the application of water power."—*Mining Journal*.

TIN-PLATE WORKING, By R. H. CLARKE. An Up-to-Date Practical Handbook for the Tinsmith, Student, and Amateur. Specially compiled for the Manual Training Teachers' City and Guilds Examination. Just Published. Price 1s. 6d. net, post free 1s. 8d.

"A very practical handbook."—*Electrical Review*.

"Altogether a well thought out little manual."—*Ironmonger*.

"This well-illustrated and well-turned-out book deserves and has our hearty recommendation."—*Manual Training*.

EXPERIMENTS ON THE PRESSURE AND EXPLOSIVE EFFICIENCY OF MIXTURES OF ACETYLENE AND AIR. By FREDERICK GROVER, A.M.Inst.C.E., M.I.Mech.E., Author of *Modern Gas Engines*, &c. Price 1s., post free 1s. 1d.**SIMPLE STRUCTURAL WOODWORK.** By GEORGE F. RHEAD (National Silver Medalist). The Popular Technical Manuals No. 2. Crown 8vo, 120 pages, price 2s. net, post free 2s. 3d. This book comprises a series of practical examples for schools, handicraft classes, and the home, planned to meet requirements of the City and Guilds Institute examinations.

"Manual training teachers and scholars will be glad to avail themselves of this little book."—*Work*.

"The purpose is well fulfilled, the text being lucid and practical and the illustrations excellent."—*Surveyor Municipal and County Engineer*.

TRUTH ABOUT THE BELLEVILLE BOILER IN THE BRITISH NAVY. By ENGINEER WILCKE. Price 1s. 6d. net.**HOW TO INVENT MACHINERY.** By CHAS. BABBAGE, M.A. Price 4d. net, post free 4½d.

NOTES ON BOILER TESTING. By FREDERICK GROVER, M.I.Mech.E., A.M.Inst.C.E., &c. Price 1s., post free 1s. 2d.

PRINCIPLES OF FITTING. By J. G. HORNER. Price 5s. net, post free 5s. 3d.

SPLICING WIRE ROPES. By W. N. BRUNTON. Price 6½d. post free.

WORKING OF STEAM BOILERS, being Instructions respecting the Working, Treatment, and Attendance of Steam Boilers. By EDWARD G. HILLER, Chief Engineer, the National Boiler and General Assurance Co. Limited. Price: Paper Covers 1s.; Cloth 1s. 6d. net. Postage 3d. extra.

NOTES ON THE MATERIAL, CONSTRUCTION, AND DESIGN OF LAND BOILERS. By EDWARD G. HILLER, M.I.C.E., M.I.Mech.E., Chief Engineer, National Boiler and General Insurance Co. Limited. Price: Paper Covers 1s.; Cloth 1s. 6d. net. Postage 3d. extra.

ELECTRICAL TERMS AND PHRASES. In Shorthand (Pitman's). Especially valuable to the Shorthand Writer in Engineering Offices. By E. J. RUTLAND. Price 1s. nett, post free 1s. 2d.

THE EVOLUTION OF MODERN SMALL ARMS AND AMMUNITION. By E. C. R. MARKS. Price 5s. net.

OPENING BRIDGES. By GEO. WILSON, M.Sc. Price 2s. net.

TURNING LATHES. A Manual for Technical Schools and Apprentices. A Guide to Turning, Screw-cutting, Metal Spinning, &c., &c. With 194 Illustrations. By J. LUKIN, B.A. Demy 8vo, cloth, price 3s. net, post free 3s. 4d.

STEAM BOILER CONSTRUCTION. A Practical Handbook for Engineers, Boilermakers, and Steam Users. By WALTER S. HUTTON, With upwards of 500 illustrations. Fourth Edition. Carefully Revised and Enlarged. Medium 8vo, over 680 pages, cloth, strongly bound. Price 18s., postage 1s. extra.

THE INTERNAL LUBRICATION OF STEAM

ENGINES. A practical treatise. By T. C. THOMSEN, M. Soc.D.C.E. Illustrated. Crown 8vo, cloth, price 2s. 6d. net, post free 2s. 9d. The losses due to inefficient lubrication have generally been considered a negligible quantity, while the question of the best oils for their respective purposes are often less considered. This book is the result of much research and experimental work during many years, and carried out with high grades of oils. The proper methods of introducing the lubricant are fully treated, and the subject is clearly dealt with throughout.

"The book is of a decidedly practical character."—*Machinery*.

THE DESIGN OF CONDENSING PLANT.

A practical treatise by F. W. WRIGHT. With numerous tables and fully illustrated. Crown 8vo, cloth, 200 pages, price 3s. 6d., post free 3s. 10d.

"We recommend this book to all who have to do with or to design condensing plant."—*Steamship*.

The book is practical in its character."—*Machinery*.

FLYING MACHINES: PRACTICE AND DESIGN.

Their principles, construction and working, by RANKIN KENNEDY. Large 8vo, 158 pages, 62 illustrations, price 5s. net, post free 5s. 4d. Popularly treated, but upon a strictly scientific basis and with new formulæ, rules, measurements and principles.

NOTES AND JUDGMENTS ON THE

"WORKING" OF BRITISH PATENTS. By G. CROYDON MARKS, M.P., A.M.Inst.C.E. Crown 8vo, cloth, price 2s. 6d. post free. These notes have been prepared for the guidance of those interested in the "working" of British Patents, and have reference mainly to Section 27 of the 1907 Act.

RAMIE (RHEA) CHINA GRASS, THE NEW

TEXTILE FIBRE. All about it. A book for planters, manufacturers, and merchants. By HERBERT A. CARTER. Large crown 8vo, 140 pages, with numerous illustrations, cloth, price 5s. net, post free 5s. 4d. This book is the outcome of a demand for a text book on the new textile fibre, owing to the great increase which has arisen in the spinning and weaving of it in Europe and the United States.

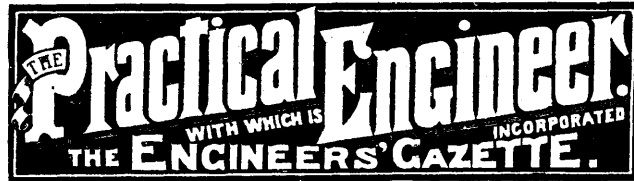

Established 1887. Price 2d. Weekly.
Published Simultaneously in London and Manchester every Friday.

THE LARGEST & BEST
WEEKLY JOURNAL OF
MECHANICAL & MOTIVE
POWER ENGINEERING

OUR Staff of Special Contributors includes some of the most eminent men in the profession, whose articles are of great value and interest to those who would be kept up to date in matters of moment to Engineers and Manufacturers.

ANNUAL SUBSCRIPTION:

United Kingdom - - - - 10/- post free.

Foreign Countries - - - - 12/6 post free.

Sample Copy Post Free on application.

THE TECHNICAL PUBLISHING CO. LIMITED,
55 AND 56, CHANCERY LANE, LONDON, ENGLAND;
D. VAN NOSTRAND Co., 23, Murray Street, and 27, Warren Street, New York;
E. W. COLE, Sydney, Adelaide, and Melbourne, Australia;
GEO. ROBERTSON AND Co. PROPRIETARY LIMITED, Melbourne, Sydney,
Adelaide, and Brisbane;
CENTRAL NEWS AGENCY, Capetown, South Africa;
GORDON AND GOTCH, Australasia;
Z. P. MARUYA & Co. LIMITED, Tokyo and Yokohama, Japan;
and of all Booksellers.