

Creating
Coggeshall Lace

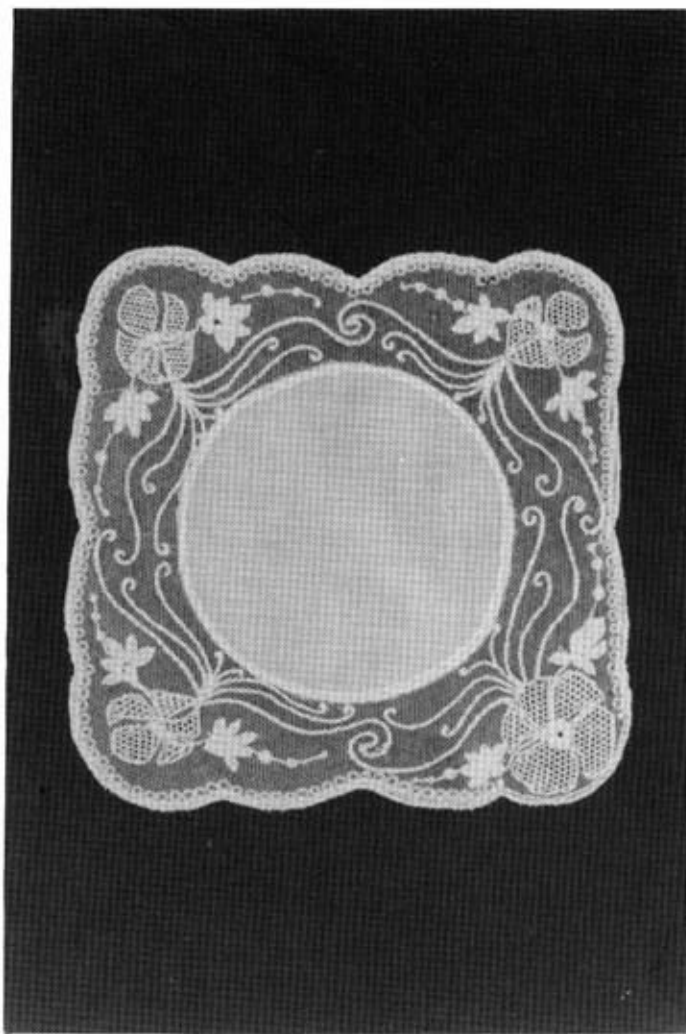

Jean Dudding

Contents

	Page
1. Introduction	1
2. The Background to Coggeshall Lace	2
3. Requirements for the making of Coggeshall Lace	4
4. The Preparation of Equipment before Tambouring	6
5. Instructions for Tambouring	8
6. Design	17
7. Methods of Transferring the Design to the Net	21
8. Decorative Filling Stitches	21
9. What shall we make?	24

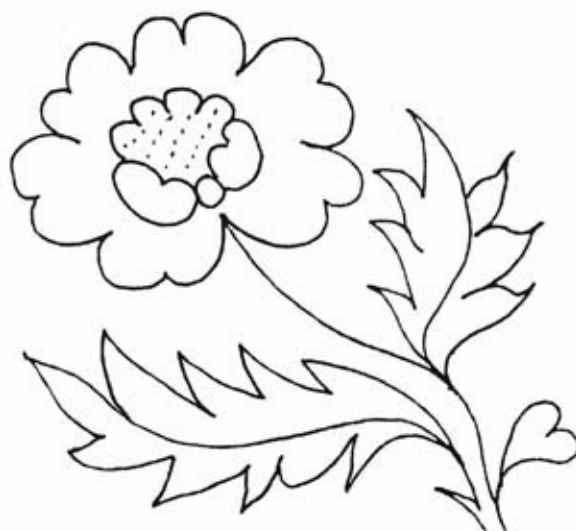

Introduction to revised edition

Since the publication of "Creating Coggleshall Lace" in 1979 a large number of lacemakers and others have used the book as a manual for tambouring lace. Over the years it has become apparent to me that certain improvements could be made and I have incorporated these in this edition.

My thanks go to Zandra Stillwell for her Diagrams No.3, 4a, 4b, 4c and 4d, also for Diagram 8. Again my thanks are given to Jane Crowther for preparing my script for the printers.

Jean Dudding
July 1988

*Best wishes and thank you Zandra
Jean Dudding
September 1988*

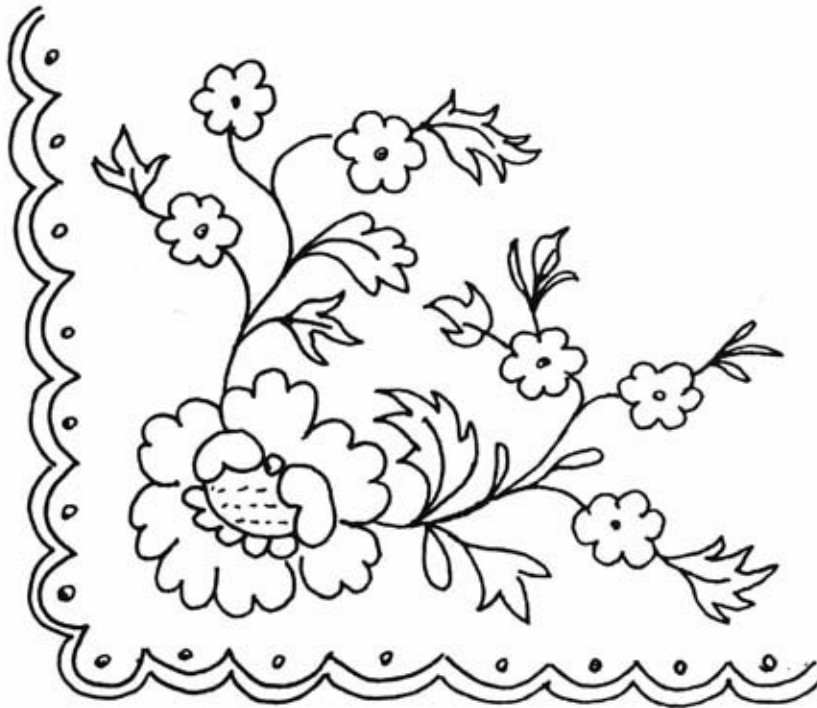

FURTHER NOTES ON COGGESHALL TAMBOUR LACE.

Since "Creating Coggeshall Lace" was written in 1979 there have been several developments which I hope may assist you further when making Coggeshall Tambour Lace.

New suitable threads are difficult to discover. For the outlines, Fil á Dentelles No. 70 and DMC mercerised cotton Nos 80-100 and 120 are still being used, while for the fine filling stitches, now that Retors D'Alsace No 60 is no longer available, No 50 is the substitute. However, you should experiment with other lacemakers' threads for the filling stitches. Brok and Honiton both give good results.

Some students have found difficulty in commencing to tambour. I have discovered that some old lacemakers commenced by merely picking up a loop of thread through a hole with their hook. They then proceeded to tambour. Since chain stitch only unravels in one direction, (from the end but not the beginning) this is quite satisfactory. I find that if the short end and the continuous thread are wound together around the hook for the first tamboured stitch, it can be a quick and easy method of commencing, especially when working isolated spots etc.,. However the knot stitch is still the most satisfactory method of finishing, although many old lacemakers were content with the simple method; see page 16 of "Creating Coggeshall Lace".

Since the cotton net is apt to shrink when washed it is advisable to wash before proceeding to tambour, unless shrinkage is not of vital importance.

When transferring the design, a pencil is now available at most haberdashery stores, which washes away. (This is used extensively by quilters). The design is held behind the net and is transferred onto the net using the pencil. The point of the pencil is inclined to give a rather thick result, but it is useful to indicate the line of the design. Always wash off the pencil marks before removing the lace from the frame. Make sure that the net is dry before unpinning. However, for most designs I personally prefer the old method of enlarging holes along the line of the design as the work proceeds.

When strengthening the edge of the lace, "neat" "line" and "zig-zag" stitches can all be used. These are sometimes all used in one piece of work when "overcasting" some edges, e.g. where there are sharp points or scallops. The main purpose is to give a strong edge.

Jean Dudding
1984

Introduction

The aim of this little book is to provide a simple manual on the making of tamboured net lace. It is primarily for those who are beginners in this craft. Each craftsman who indulges in tambouring has his/her own individual ideas on technique and general approach. I have attempted to set down a concise simplified method from which each worker can develop his/her own technique.

When beginning to tambour, the golden rule is to PROGRESS SLOWLY until the individual movements of tambouring become automatic.

The working of this lace is a rewarding pastime and I hope many of you will enjoy making it and become "hooked" on Coggeshall Lace.

So many people have given me encouragement, shared their knowledge and given me support over the past 2½ years since we launched the making of this lace. Therefore the following list is very incomplete:

Mrs. N. Bottomley	Mrs. J. Merrifield
Miss J. Edwards	Mrs. C. Potts
The Essex Handicrafts Association	Mrs. Quintin Riley
Mrs. M. Fulbeck	Mrs. J. Saunders
Mrs. B. Johnson	Mrs. A. Sterck
	Mrs. B. Woolgar

photographs by Mr. D. Menzies and Mr. W. Goodwin
and the unfailing help of my husband in reading the
script and general advice.

Many thanks to all named and un-named!

JEAN DUDDING
September 1979

The background

It is reported that a few years after 1809, the year in which John Heathcote invented a machine in Nottingham which made a strong bobbin type net, a French emigré M. Drago and his two daughters settled in Coggeshall, a village in Essex. Here they hired a room and began to teach the women and small children a method of decorating this net by using a tambour hook. Thus began the making of Coggeshall Lace.

Tambouring produces a line of chain stitches and originated in the Far East, where the workers used a round frame resembling a tambourine or drum. This they could grip between the knees, thereby releasing both hands for tambouring. (Diagram 1).



Diagram 1

Coggeshall workers used a rectangular frame. This type is the most satisfactory for working today. It can be either an embroidery frame, a picture frame, an artist's stretcher or a homemade frame. The criterion is a good strong framework on which to stretch and attach the cotton sheeting on which to mount the net.

Throughout the 19th century this tamboured net lace was made in the tambour rooms and cottages of Coggeshall, and also in the homes of surrounding villages.

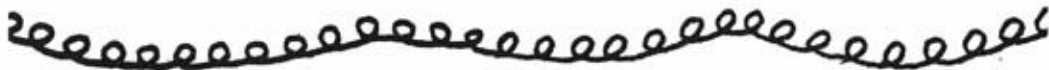

Lace manufacturers and lace dealers co-ordinated these workers by obtaining orders from London and elsewhere. Sometimes more sophisticated designs were introduced and these would be tamboured by the more proficient workers. Besides the designs, all the necessary net and threads would also be distributed to the lace workers. Liberty & Co., amongst others, were supplied with Coggeshall Lace.

The fluctuations in prosperity of the tamboured net lacemakers were governed by many factors. Fashion requiring flounces and frills gave great encouragement but the invention of chain stitch sewing machines and of machine made laces imitating the hand made article, together with a deterioration in the quality of design meant hard times for the laceworkers.

Just after 1900 there was a great improvement in the quality of Coggeshall Lace. This was due largely to the activities of the two Misses Spurge who were the chief employers in the district. Their brother William was an art teacher who improved the general standard of design and also introduced some old Italian designs.

Good designs and good craftsmanship must go hand in hand.

The First World War resulted in a decline in the making of Coggeshall Lace. The workers found it more profitable to do tambour beading. In the 1930's a determined effort was made to revive the making of Coggeshall Lace, and three handkerchiefs were given to Princess Marina on her marriage. Coggeshall Lace was made into dresses for the Queen, Princess Margaret and Princess Alexandra. This work was undertaken by three very proficient workers in Great Tey. Queen Mary also chose two lace dresses and a tea cloth in Coggeshall Lace. It was hoped that this Royal Patronage would encourage a revival of the craft. However the financial return was too meagre and after the Second World War both net and threads disappeared. Consequently Coggeshall Lace was no longer made.

However it is encouraging to relate that since the publication of my booklet on Coggleshall Lace in 1976 and the general resurgence of interest in lace, the making of this lace has been re-introduced. Cotton net is again available, tambour hooks more readily obtainable.

Requirements

Cotton net size No. 844 for learning to tambour on net.

Cotton net size No. MP969 for the majority of lace making.

Threads D.M.C. mercerised cotton No. 80 or Fil à Dentelles No. 70 (small ball). These may be used on both sizes of net.

A fine thread Retors D'Alsace No. 60 is used for the filling areas.

Coggleshall Lace is one of the embroidered net laces. Unlike other laces of this family where some or all of the lace is worked with needle and thread, true Coggleshall Lace is worked entirely with a tambour hook.

When learning to tambour it is important that the thread has a tight twist; this discourages the snagging and splitting of the thread. Experiment with other lace threads when proficient.

Tambour handle and hook

The handle should have a screw; this allows the interchange of hooks. Hooks come in various sizes; a medium or large size is best when commencing. Remember that the hook itself is dangerous and should never be left outside its holder or without the protection of a cork. An empty cigar case makes an admirable holder.

Stiletto

This is very useful for enlarging holes in the net. A fine knitting needle would suffice.

Frame

A rectangular frame is the most satisfactory. If a round frame is used it must be attached to a stand to allow both hands to be free. Always bind the lower ring of a round frame with tape. This prevents the net from slipping when the outer ring is placed in position.

A piece of white material attached to the frame should be available to cover the lace when not being worked.

A dark piece of material (blue or green is excellent) can be laid over the knees as a background for the net or alternatively a **plain dark material skirt**. This is a tremendous help in resting the eyes.

Small box with hole in the lid holds the thread below the net.
Cotton sheeting is used to mount the frame.



Preparation

Mount a rectangular frame with cotton sheeting. Before attaching the net to the cotton sheeting look closely at the mesh of the net. (Diagram 2). You will see that the lines of the holes in one direction are further apart than the lines of holes in the other directions. When applying the net to the cotton sheeting the horizontal mesh should be close to each other (as also in the N.E., N.W., S.E. and S.W. directions). This fact influences the direction of the filling stitches and should be borne in mind when designing.

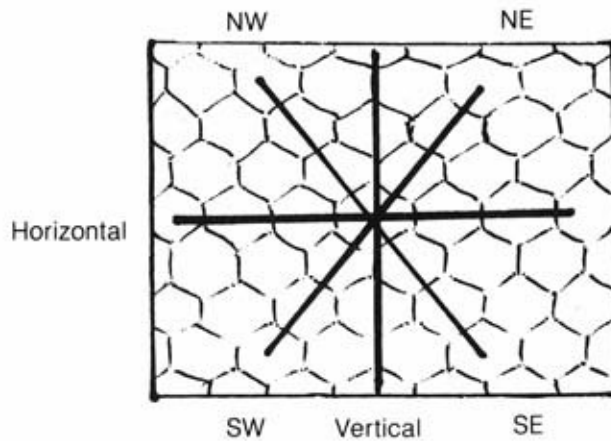

Diagram 2



Pin the net to the sheeting; cut away the sheeting from behind the net. To avoid damaging the net use the rounded point of scissors between the sheeting and net. IT IS ESSENTIAL THAT THE NET REMAINS TAUT. By using pins to attach the net, adjustments can be made to the tension as and when required. (Diagram 3). Balance the frame between two tables or equivalent so that both hands are free to tambour.

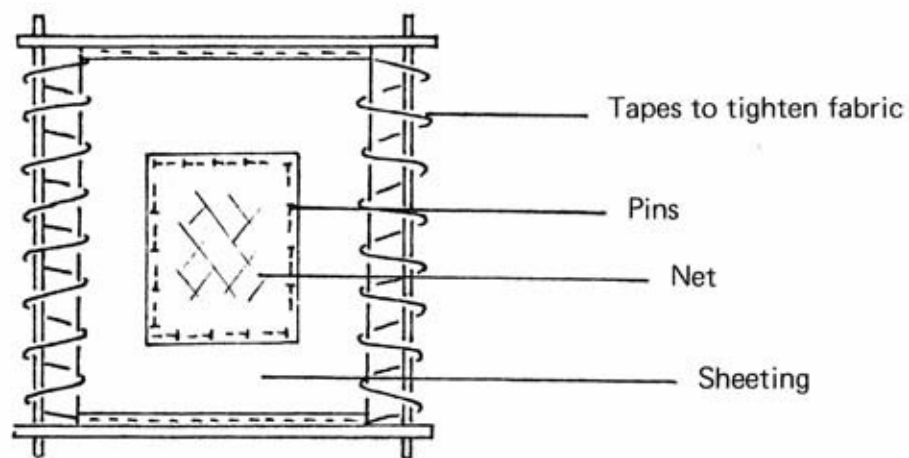

Diagram 3

Coggeshall workers set their spool of thread on a nail attached to their large frames, but the following is an alternative method which keeps the thread clean. On the floor beneath the frame place a small box with a pierced lid to hold the thread, e.g. a cottage cheese carton. This hole allows free movement of the thread from container to net. Insert the tambour hook into the handle making certain that the screw and hook are facing in the same direction. These should always face forward along the line of progression. A medium sized hook is the best size to use for most tambouring.



Instructions

To begin.

- 1) Hold the thread between thumb and first finger of left hand below the net (Diag. 4a)
- 2) Bring loop to the surface on the hook held in the right hand (Diag. 4b)
- 3) Insert hook with loop in adjacent hole, wind the double thread around hook (Diag. 4c.)
- 4) Bring double loop to surface (Diag 4d)
- 5) Leave the short end free above the net and then proceed to tambour.

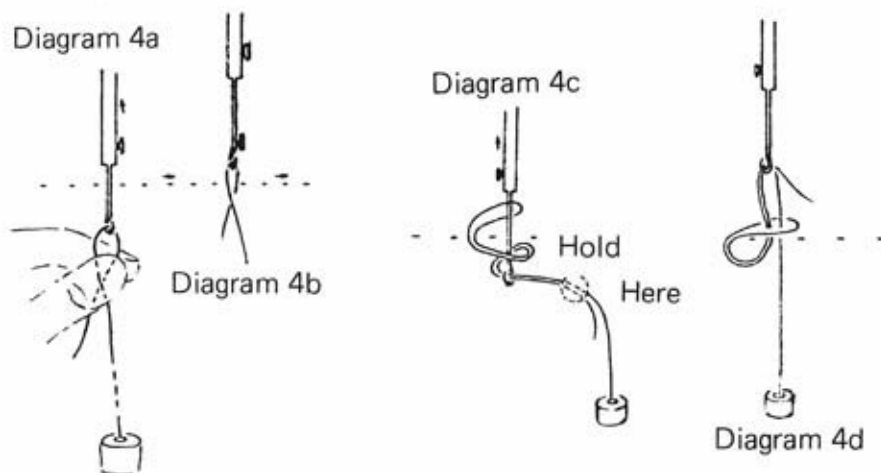

The Movements

1. Hold the handle of the tambour hook in your right hand (screw and hook facing the direction of progress) and insert the hook down through hole in the net.
2. Wind the thread around the hook 1 ½ times with the left hand (then hold the thread with the left hand in the direction of progress).
3. Twist the handle round between thumb and first finger through 180°.

4. Keeping the handle upright, press the smooth side of the hook onto the front of the hole in the net. This avoids the hook itself snagging the net when the hook is retrieved (diagram 5).
5. Pull hook with looped thread through the net to the top surface and then through loop already on hook.
6. Twist the handle back to original forward position.

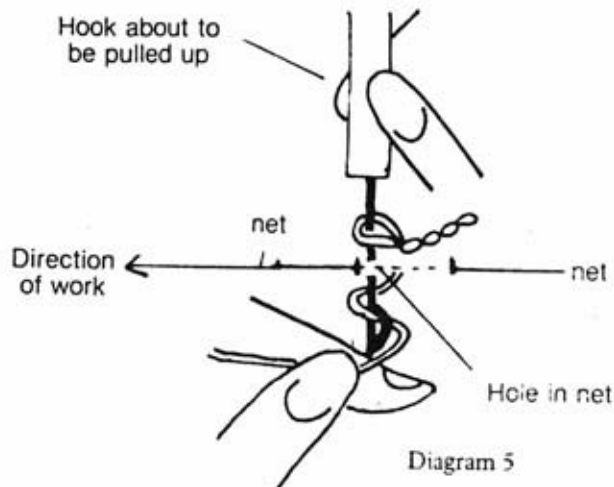

You are now ready to work your second tambour chain stitch. Movements 1, 2, 3, 4, 5 and 6

In movements No. 2 and No. 3 the winding and the twisting should be in the same direction, i.e. clockwise or anticlockwise. Always return the twist No. 6 in reverse direction to No. 3 movement. These are the basic movements of the chain stitch. Practise tambouring horizontally, diagonally and vertically, both backwards and forwards.



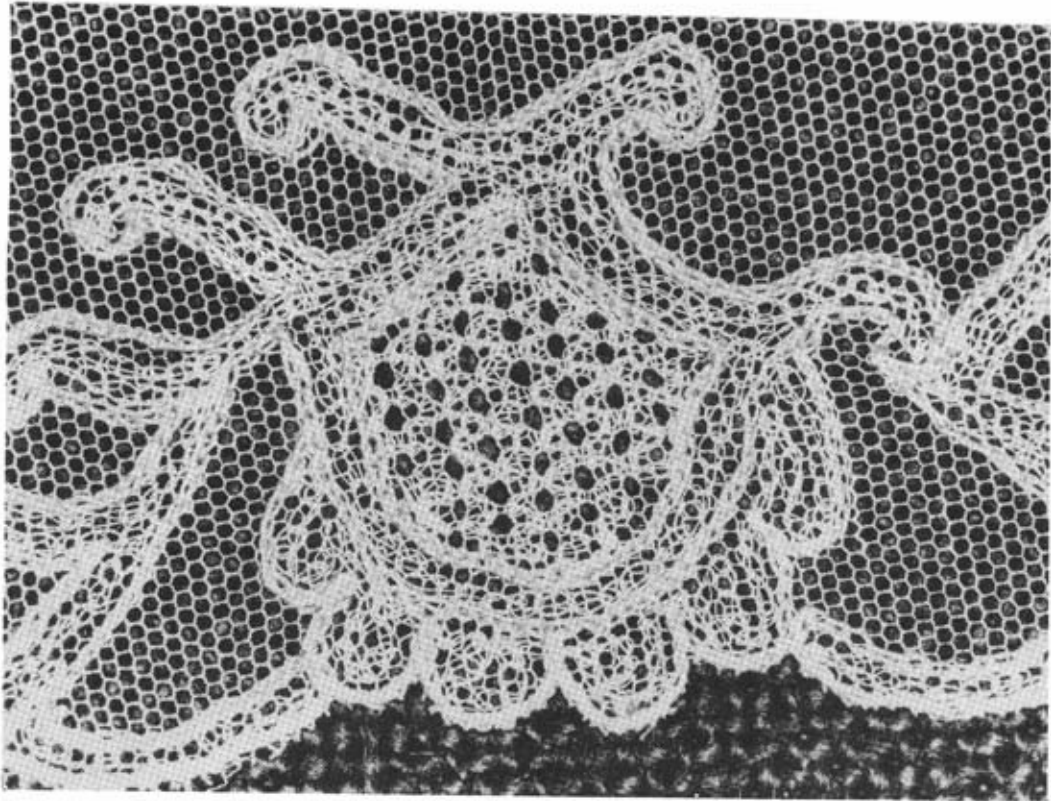

Honeycomb

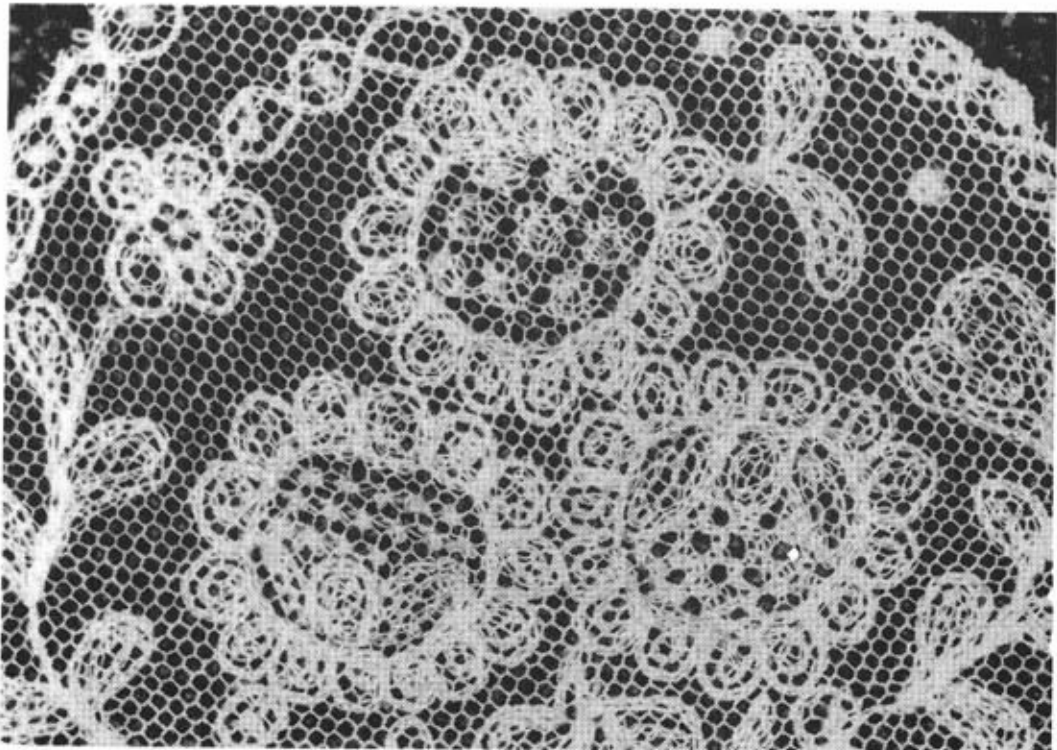

Bold Honeycomb and Spot

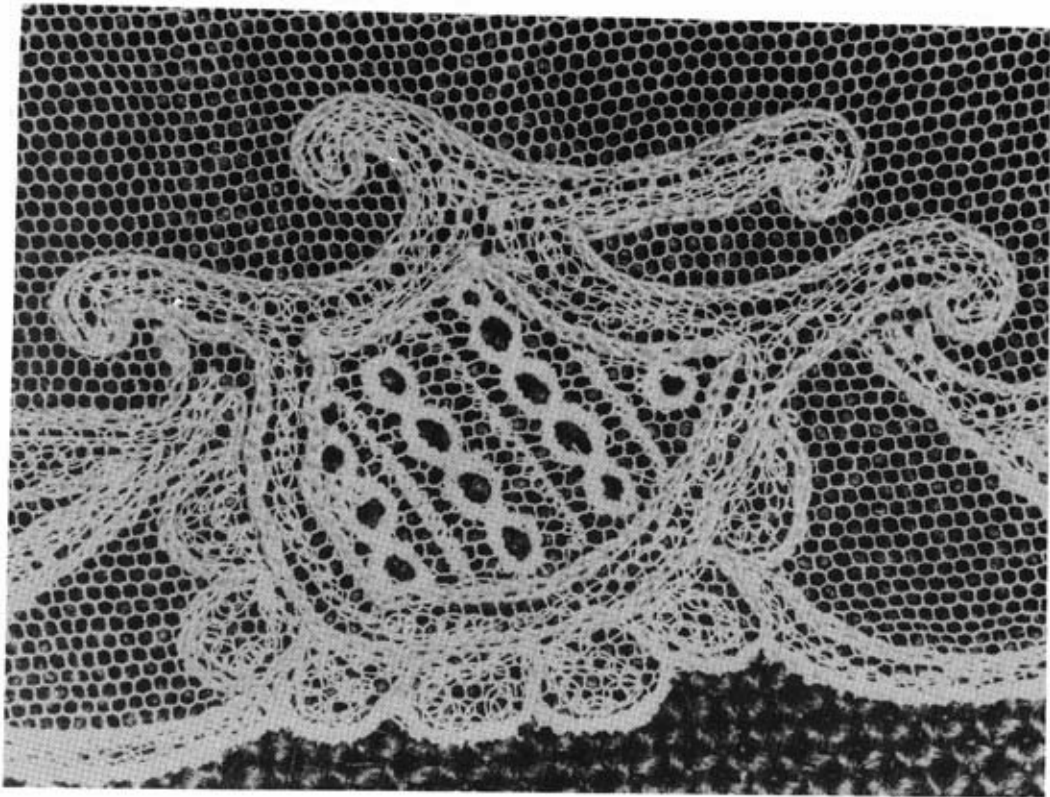

Eyelet, Line and Neat

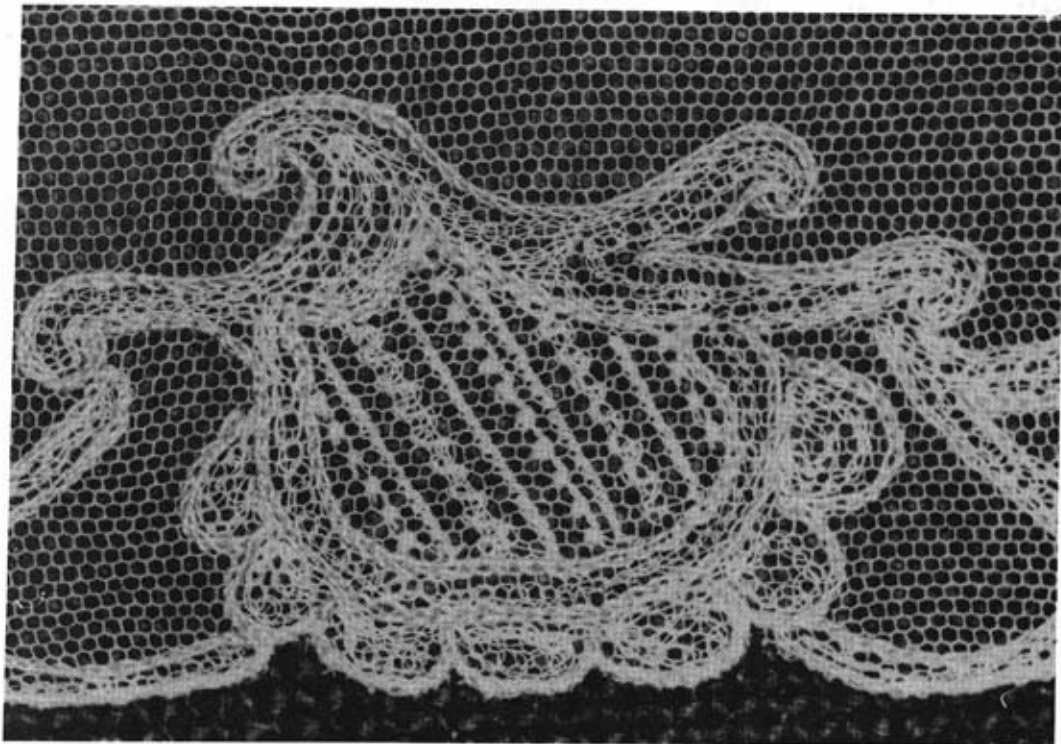

Line, Spot and Zig-Zag

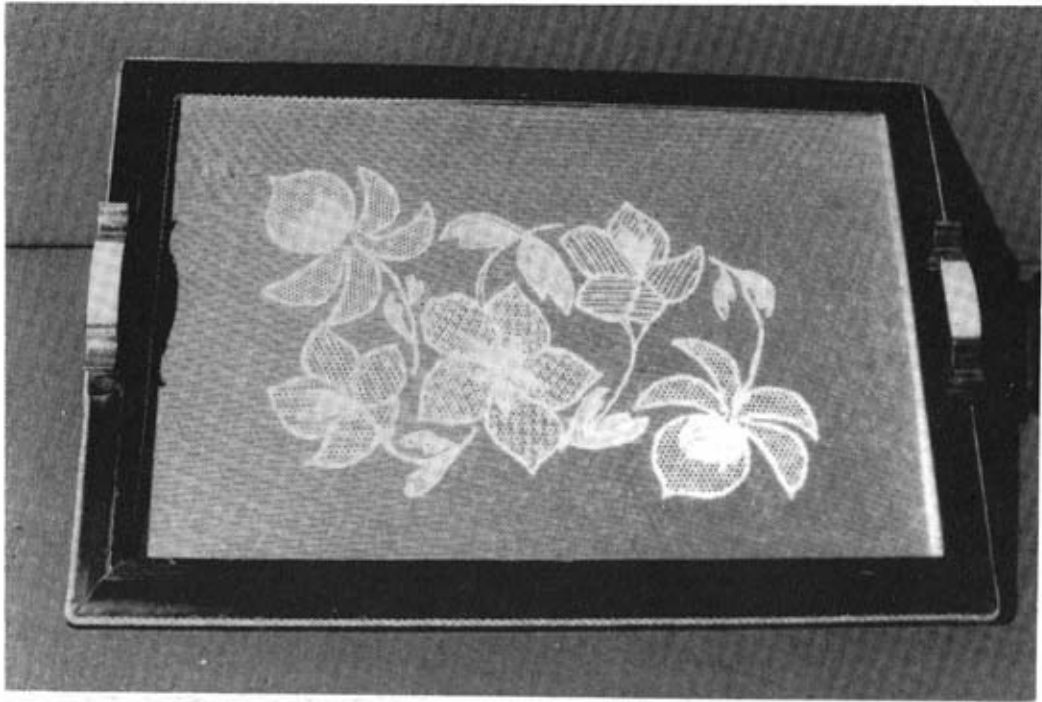

Tray with design of hellebores under glass

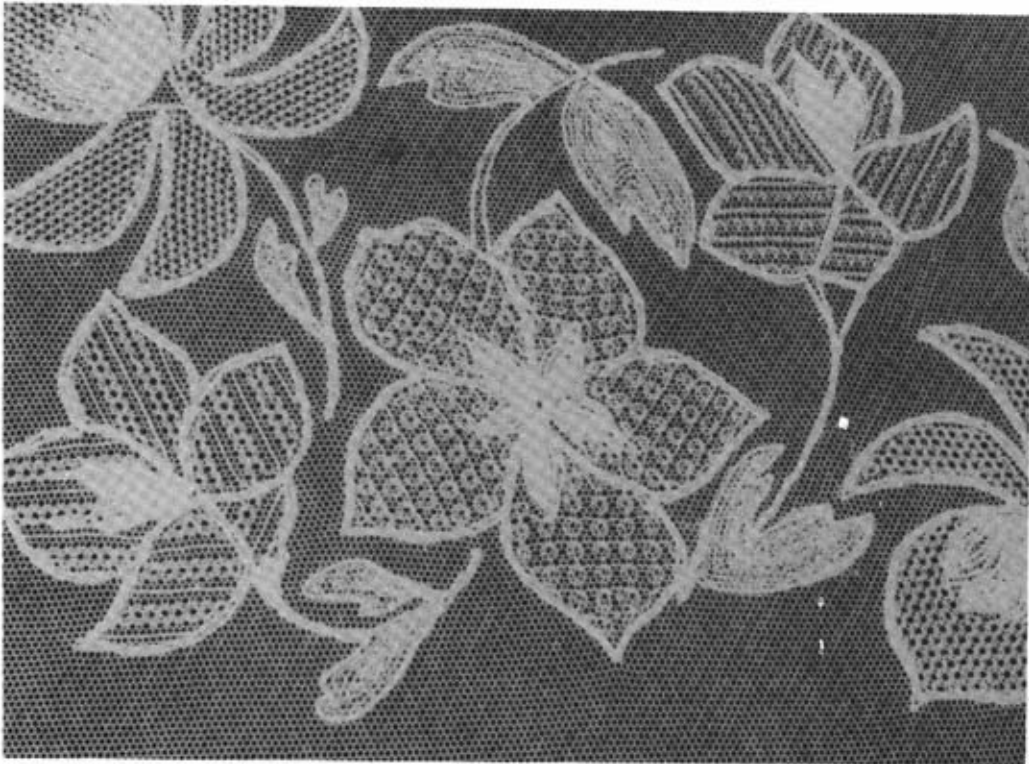

Close up of filling stitches used for petals of hellebores, bold smugger, spot, neat, honeycomb (Zig - Zag and line in corner).

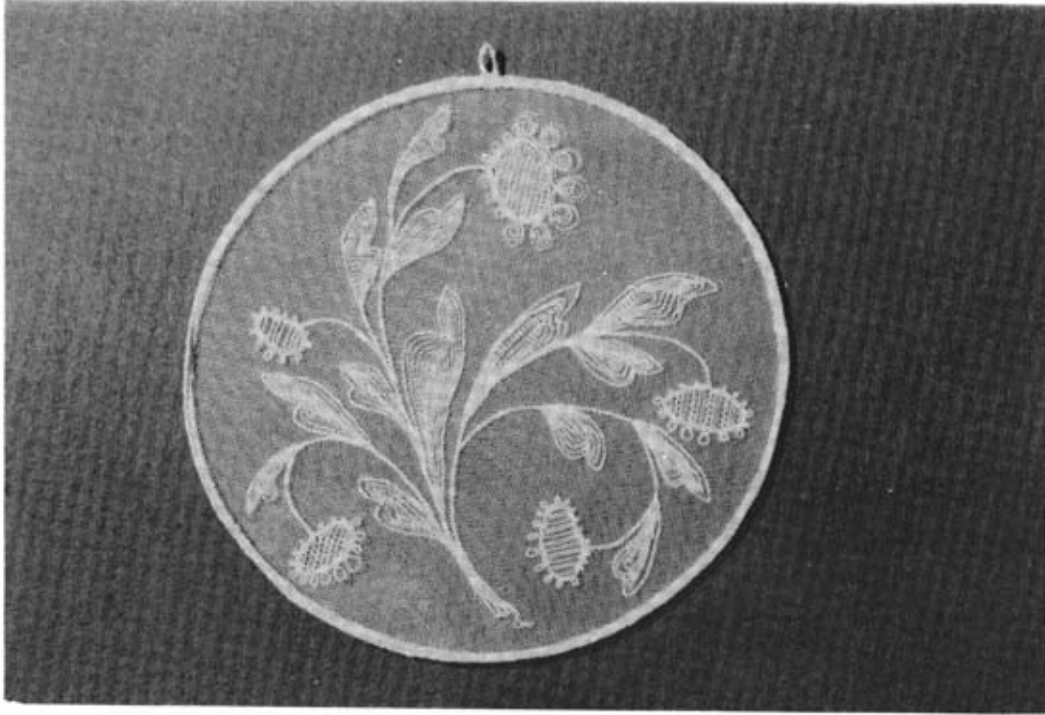

Mandala on lampshade ring. Chain stitch textures within the leaves and fitting stitches in the flower centres

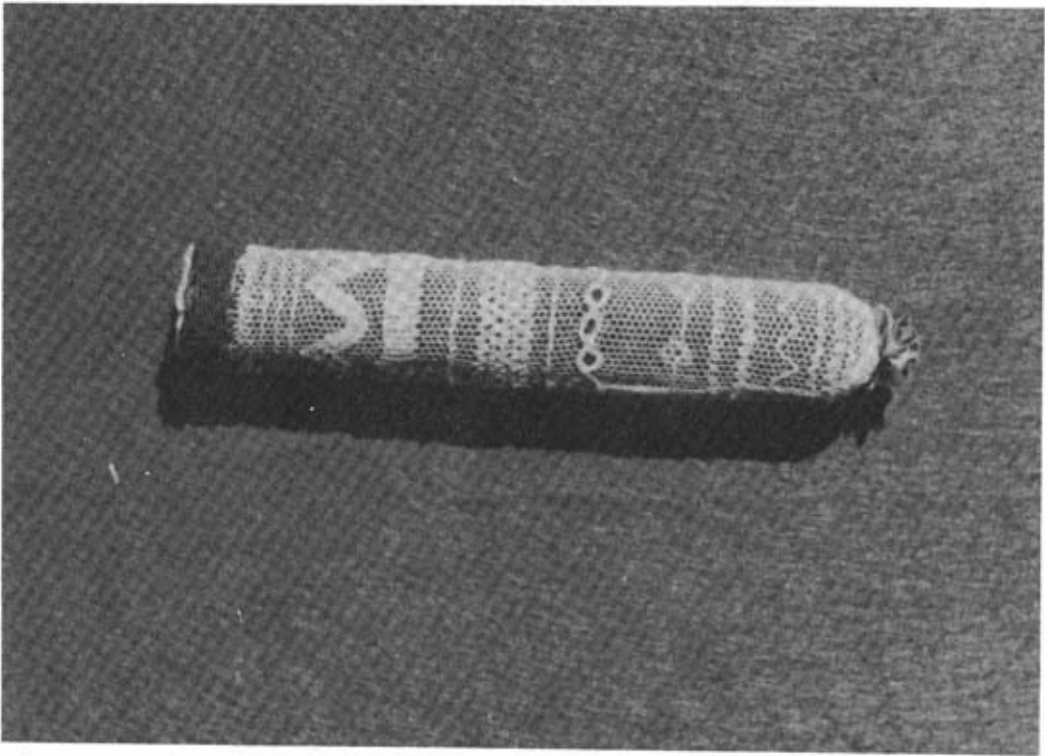

Cigar case tambour hook holder covered with Coggleshall lace by Joan Merrifield

Zig-Zag Stitch

In Coggleshall Lace a chain stitch is frequently worked from side to side or backwards and forwards **over** the line of tambouring. This is called zig-zag stitch. (Diagram 6). It is then safe to cut away the net up to this strengthened line of tambouring and thereby give an edge to the lace. Zig-zag stitch can also provide a varying texture in the actual design. This stitch may be included as a filling stitch.

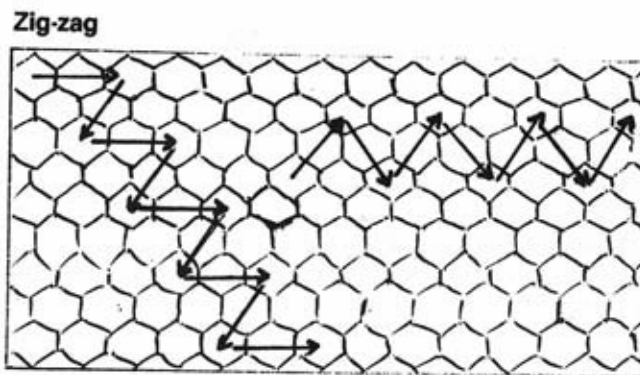

Diagram 6

Drawback stitch

This stitch is rarely found in Coggleshall Lace, but it is a recognised tambouring stitch and it is quite legitimate to include it in lacemaking as it gives added interest to the lace. (Diagram 7). The height of the drawback stitch may be varied. It may also be used satisfactorily for eyelets.

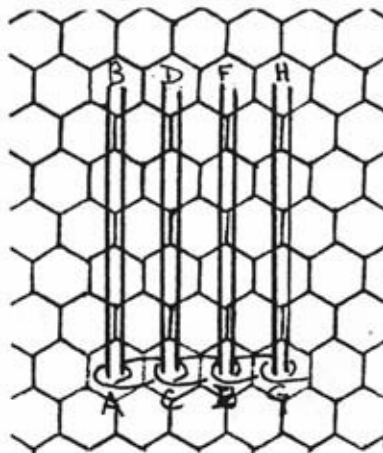

Diagram 7

Method of working Drawback stitch

1. Insert the hook into hole at A and pull loop through hole.
2. Insert hook into hole B and pull loop through hole and through loop on hook.
3. Loosen the thread at the back and gently draw the loop back. The hook is then inserted into hole A again. Pull loop through hole and through loop on hook.
4. Insert hook into hole at C and make a tambour chain stitch.

Repeat from 2-4 up to D and back to C and chain to E. Continue with these movements 2-4.

Knot Stitch

This is the most difficult stitch to master in tambouring, but it is also most useful. It is a very satisfactory method when used to commence and finish off, for the tambouring will not unravel. However the important function of this stitch is when wishing to move from one area of tambouring to another, i.e. when it is desirable to have single line of thread only at the back of the work such as when moving from one spot to another.

Method of working knot stitch

After bringing loop B through the large loop A. invert the hook itself under loop B and hold loop A (Diag. 8). Pull the thread tightly with the left hand, when loop A will emerge through loop B.

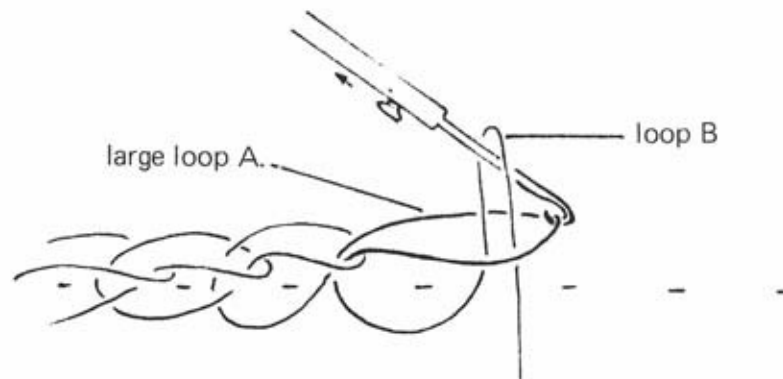

This little loop may then be pulled to the back and the tambouring is secure. This stitch is therefore an excellent stitch to use when finishing off a piece of tambouring.

Finishing off

The most satisfactory method to begin and finish off is undoubtedly by using one or two knot stitches. However, when commencing to tambour, and in order to gain confidence in the use of the tambour hook, I think it is wiser to use the simplified method of beginning as described on page 8 and to finish off with the following method:

Work three small chains (Diagram 9):

1. from A to B
2. from B to A
3. from A to B



Diagram 9

Cutting off the thread

1. Hold the thread tightly in the left hand, and the hook holding the last loop tightly in the right hand. Give a quick jerk with the right hand and the thread on the hook will be severed. This may take a little practise. From below the net insert the hook and pull down the short end of the thread to the back of the work.
2. Some workers prefer to pull the loop right through the last chain, as in crochet, cut off the thread and weave into the back of the work with a needle. A self-threading needle when available, is a great asset when using this method. Before ending the day's tambouring turn the work over and proceed to hide any little ends of thread by weaving them through the back of the work with the hook or needle.

It is interesting to note that:

1. In tambouring, the handle of the tambour hook is held erect in the right hand and the thread is **wrapped around** the hook with the left hand under the net.
2. In crochet, the crochet hook is held at an angle and the hook picks up the thread held in the left hand.

Many Coggeshall workers did in fact "pick up" the thread held under the net. It follows that each exponent of Coggeshall Lace will acquire a method and technique of their own as in crochet and all other crafts.

These instructions are given as a guide to those beginners wishing to make tamboured net lace.

Design

The designs for Coggeshall Lace were recorded on scraps of paper and handed down through families. Naturally the sources of design have nearly always been inspired by wild flowers interconnected by trailing lines and leaves. However, garden flowers have been used with great success, e.g. irises. Simple outline shapes are the best.

When designing for Coggeshall Lace remember that a continuous line outlining the various shapes is a great advantage, as it prevents a break in the rhythm of tambouring.

A break in the line may be treated in one of the following ways:

(a) A complete break of thread preceded by a "knot stitch" or "finish off".

(b) If the start of the next area to be tamboured is near, work a "knot stitch" carry the single thread along the back of the net to the commencement of the next line of tambouring.

(c) It is sometimes possible to zig-zag over the original chain stitch on the return journey. Alternatively work a second line of chain stitch in juxta position to the first line.

To provide a sharply angled point or corner

Due to the nature of the net, corners and points become softened when tambouring. Therefore in order to rectify this, always tambour into the hole beyond the point or corner and back into the corner chain of the design. Then proceed with the planned line of tambouring.

METHOD OF WORKING REGULAR SHAPED FLOWERS — Small spot flowers

Enlarge a mesh with a stiletto. You will see 6 further holes lie around this central hole. Work a chain stitch into the 6 holes and you have a small spot flower. Many of these worked in isolation frequently decorate the background of net (Diagram 10).

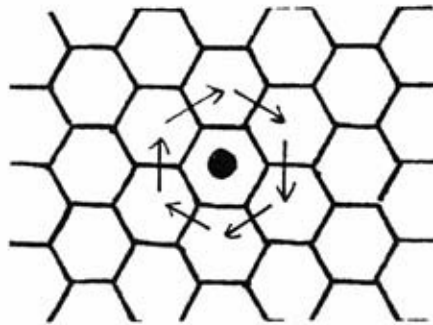

Diagram 10
Small flowers



Regular petalled flowers

Enlarge the centre hole with the stiletto and work 6 small spot flowers around the central hole in the net. (Diagram 11), A, B, C, D, E, F, A, and then G, H, I, J, K, B, G, L, etc. By studying the composition of the net you will be able to design larger flowers. (Diagram 12). It is wise to always enlarge the centre hole as this guides the eye. Zig-zag stitch can be used over the initial chain stitch of the flowers and in some cases drawback stitch.

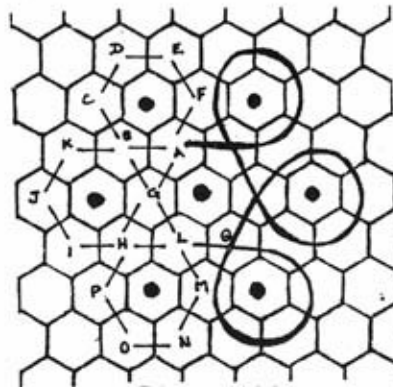

Diagram 11.

Regular petalled flowers

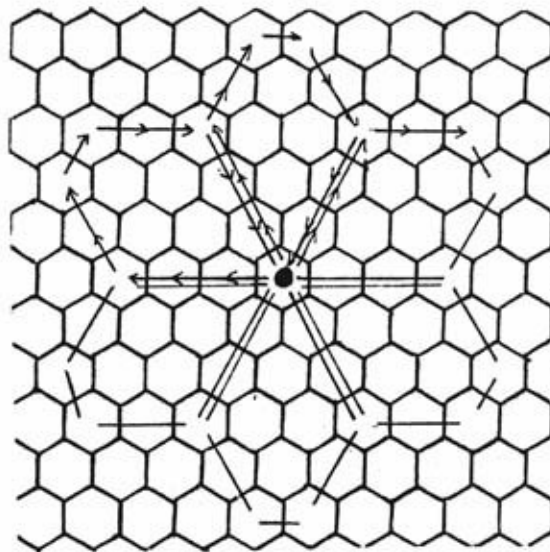

Diagram 12.

Large flower

Methods of working asymmetrical flowers and leaves

The petals and leaves are usually outlined with chain stitch and with coarse thread, while the spaces within these shapes are worked with rows of chain stitch with a fine thread. Some Coggeshall workers favoured a large hook and loose stitch with this fine thread, "slack stitch", while others maintained neat rows of chain stitch with a fine or medium sized hook. Both give a varied texture.

In all designs, the spaces left between the arrangements of the main subject matter are most important. This is particularly so with Coggeshall Lace, for you will often find that these areas near the edges of the border are decorated with the filling stitches and are called "caskets". (Diagram 13). The filling stitches are also to be found in the larger spaces in the centres of the daisy type flowers.



Decorative filling stitches Ziz-zag edging

Diagram 13

Simple designing

The flower and leaf motifs found in this book are some of those used in Coggeshall Lace, and are included to aid you when designing.

Firstly draw to scale on paper the area you wish to tambour, i.e. the corner of a handkerchief. Make templates of the various flowers and leaves. Move these shapes around within this area until a satisfactory arrangement has evolved. Add flowing lines of stem (some adjustment may be necessary to allow the flowers and leaves to "grow" from the stems).

Finish the design with one of the edgings.

Transferring the design

Copying the design on to the net presents a real problem in Coggeshall Lace. It is not possible to tack the design to the underside of the net to copy the outline as it is necessary for the thread to be held under the net. Therefore the Coggeshall workers would tack one side of the design paper or calico to the underside of the net. This they would periodically hold up against the net when they would enlarge the mesh with their stiletto at intervals to indicate the direction of the lines and centres of the flowers. Allowing the paper to fall, they would work this part of the design and then repeat the process. Experienced workers who were working repeat designs would be able to translate the designs by merely looking at the design paper without directional holes.

Method for beginners

Cut a template in paper of a flowing line and pin to the underside of the net. Tambour along that line. By experience you will find how to acquire a smooth curve and how to avoid an awkward angular line. This method of working with a paper template can be followed with the whole design, cutting away portions of paper as the tambouring proceeds. With practise and experience the method used by the Coggeshall workers can be adopted. Some workers advocate "pencilling in" the design on to the net, but this method is not to be recommended. The thread becomes soiled and it is very trying for the eyes.

Decorative filling stitches

After the outline of the design has been worked with the coarser thread, the areas within these shapes can be treated in various ways — chain stitch as mentioned previously or with a variety of "decorative filling stitches". In either case the finer thread is used, in order to give a light effect. These stitches were always worked by the more proficient workers in previous times. The following are a few of these stitches. Further variations can be made by combining two or more "filling stitches" in one area.

LINE

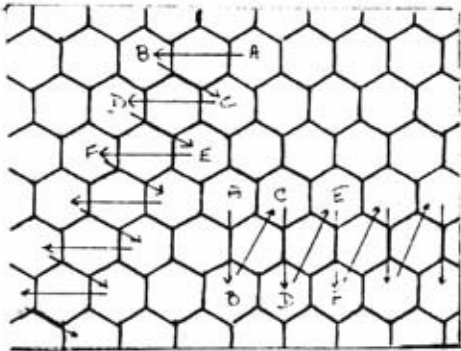

Diagonal and straight
can be used for overcasting

LARGE ZIGZAG

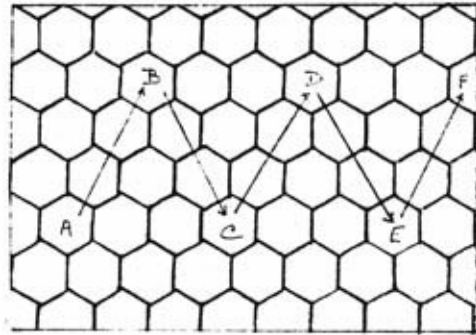

LARGE LINE

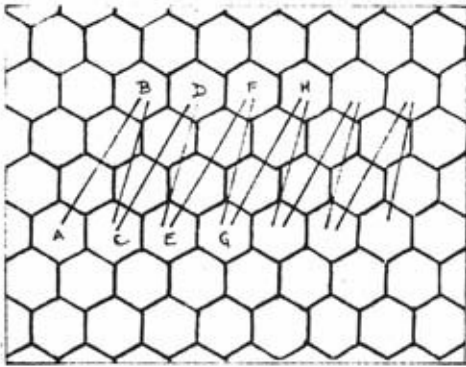

LARGE HONEYCOMB

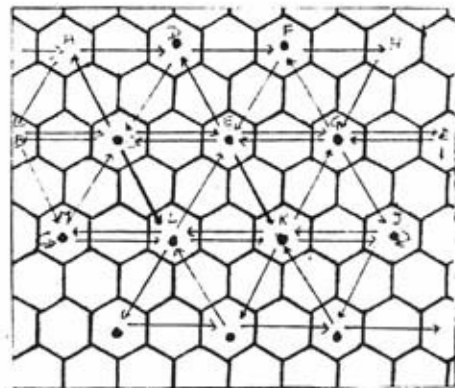

Movements - ABCA - DCED - FEGF
- HGI. Return journey in from I to GJKG
- EKLE - CLMC etc can also be worked on
diagonal.

LARGE OPEN LINE

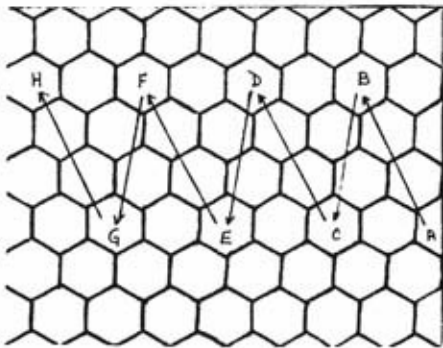

LARGE ROUNDEL

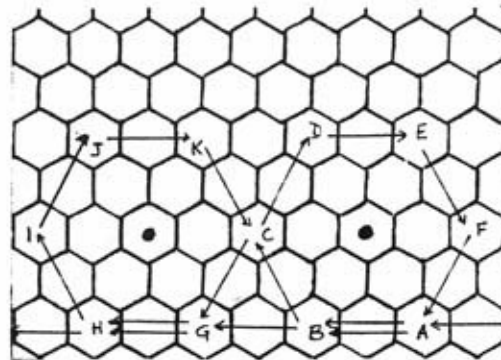

ABCDEFGHI etc

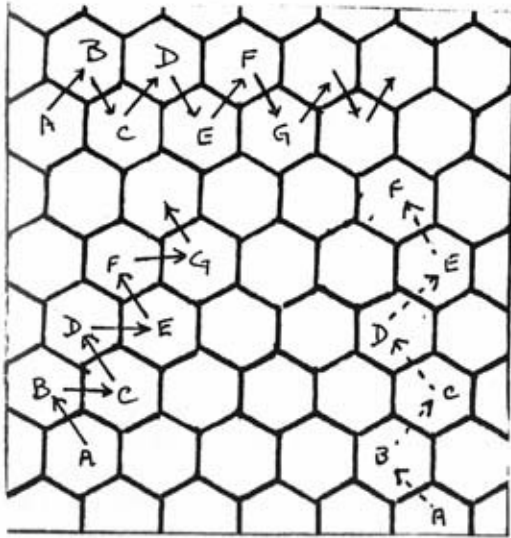

NEAT

Can be used for overcasting

--- This stitch worked in this direction is not satisfactory.

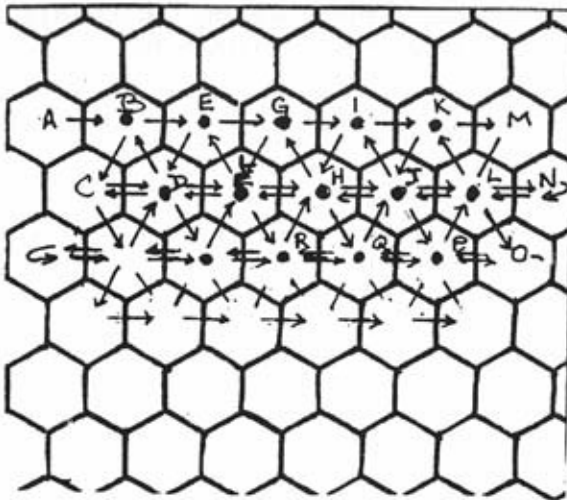

SMALL HONEYCOMB

Movements - ABCDB - EDLE

----- KJLK - MLN

Return journey in from N to LOPL - JPQJ etc. Can also be worked on the diagonal.

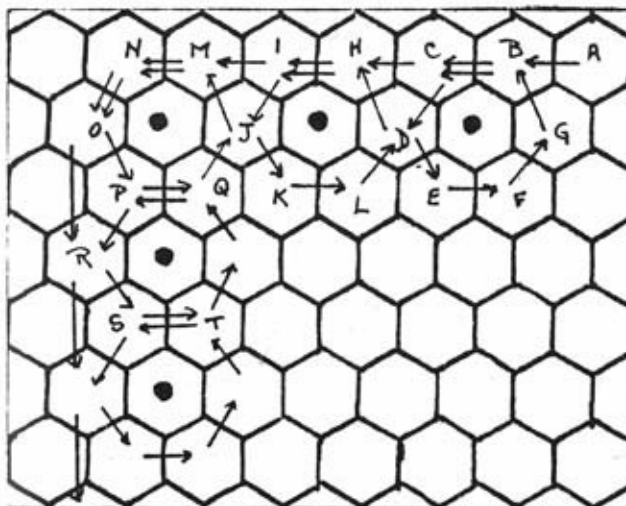

SMALL ROUNDEL

ABCDEFGBCHI etc --- to corner MNOQJMNOR etc.

What shall we make?

Finally when the art of tambouring has been mastered there comes the question of how to use the lace?

It is wise to attempt small articles once the finer net is being used. For instance, practise rows of various aspects of tambouring in a small rectangle. Mount it on plain coloured material and cover the cigar case in which you store your tambour hook.

Remember when working rows of tambouring to alter the distance between the various rows of stitches, and also vary the combination of filling stitches. This will help to give an interesting design effect.

Make little lavender bags, bookmarkers, fingerplates, paperweights, pendants, etc.

As Coggleshall Lace is a quicker form of lacemaking than the bobbin lace, there are many possibilities for including it in fashion accessories, such as wedding veils and smaller items.

It is a marvellous media for christening robes. There is also tremendous scope for experimental design in the form of wall hangings, curtains, etc.

Lastly as fashion decrees so much lace edging today, Coggleshall Lace is ideal for this. When working a lace edging it is suggested that an embroidery frame with rollers is used. The net is mounted on the cotton in the usual way, but as a long length is necessary the surplus is rolled on to the rollers and released as required. (Naturally the net is sewn on to the cotton sheeting, **not** pinned as previously suggested). In this way several widths of lace can be worked on the net as required.

In conclusion I hope that those of you who have borne with me through the pages of this little book will now be able to practise and enjoy making Coggleshall Lace.

Always remember to secure the last loop of the tamboured chain stitch with a pin, whenever the hook is removed. Otherwise the line of the tambouring will disappear!

MERCIA

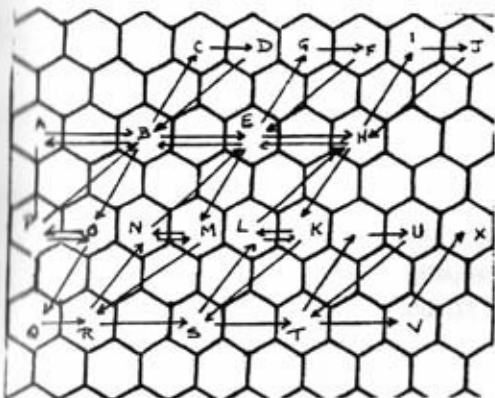

Movements ABCDB - EGFE - HIJH
Return journey KLH - EMNE - BOPB
- AP - OQ - RNMR - SLKS

QUATREFOIL

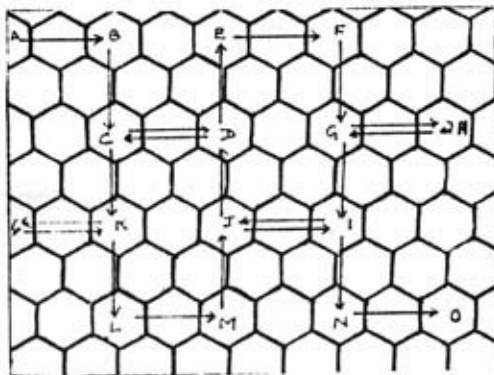

CHECK

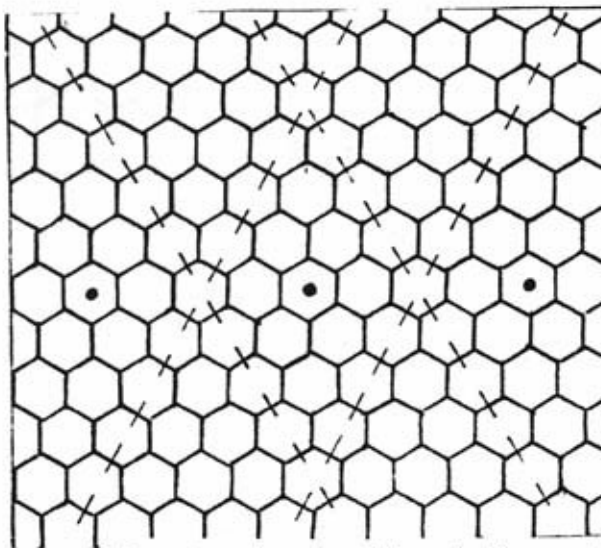

A spot can be placed in each diamond

BOLD SMUGGLER

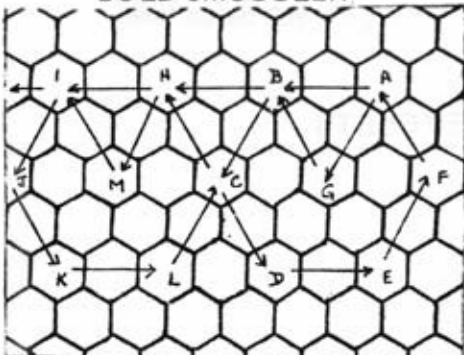

Movements - ABCDEFHGBH
In second circle H takes the place of A

SEED PEARL

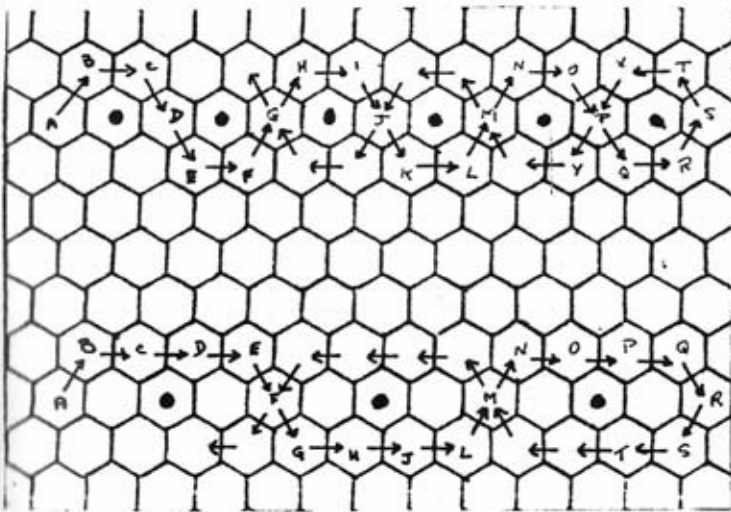

Chain stitch following direction line commencing at A. Zig-zag stitch or drawback stitch can be worked over this line into centre holes.

BIRDS EYE

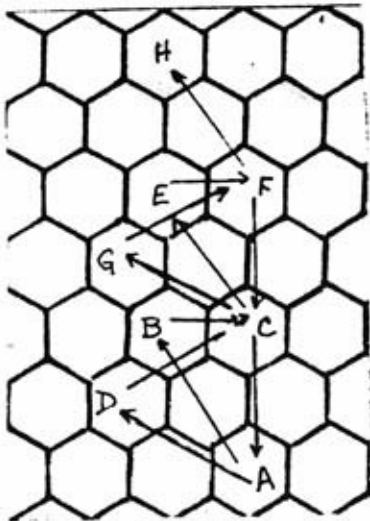

SPOT

ABC - ADC - EF - CGF
 Can also be used
 as isolated stitch.

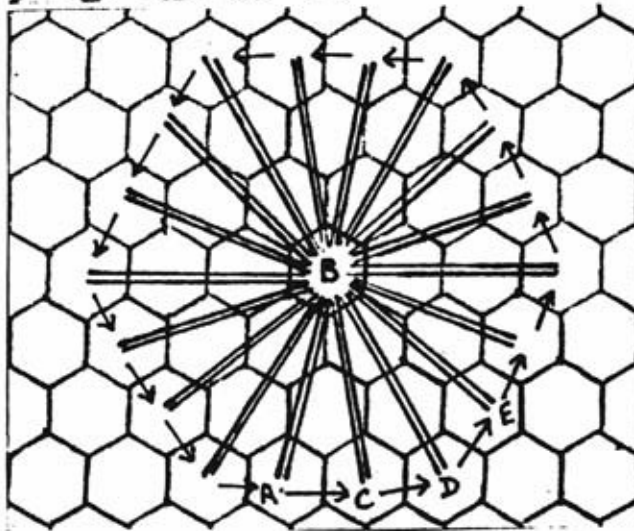

EYELETS

Worked with
 Drawback stitch
 towards
 perimeter
 Drawback ABA - chain to C
 continue around perimeter

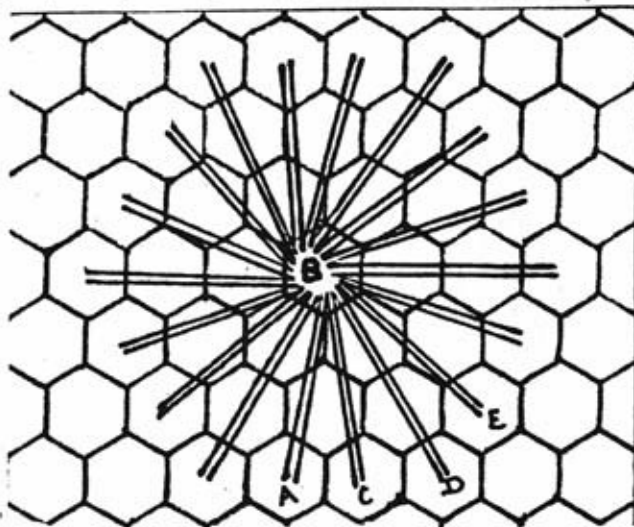

Worked with
 drawback stitch
 towards centre
 Drawback BAB
 continue around perimeter
 towards centre B.

Front cover: A 20th century design of Coggeshall Lace

Back cover: One of a set of tablemats showing "casket shapes" with decorative fillings.

Copyright: Jean Dudding 1979

Further copies of this book may be obtained from:

Mrs. Jean Dudding
137 London Road,
Braintree,
Essex CM7 8PT

"Coggeshall Tambour Lace A Short History" By Jean Dudding.

Suppliers:

"Needlework", Ann Bartleet, Bucklers Farm, Coggeshall, Colchester, Essex.
Tel. Coggeshall 61505

Coopers, 82-84 High Street, Witham, Essex
Tel. (0376) 512337

A. Sells, "Lane Cove", 49 Pedley Lane, Clifton, Shefford, Beds.
Tel. Hitchin 814-725

Folder of 12 new filling stitches

Norma Pollington
15 Westwood Road
South Chingford
London E.4

Printed by Printability, 28 - 30 Rayne Road, Braintree, Essex. Tel: 0376 - 21974

