

**WEAVING
WITH SMALL
APPLIANCES**

BOOK II—TABLET
— WEAVING —

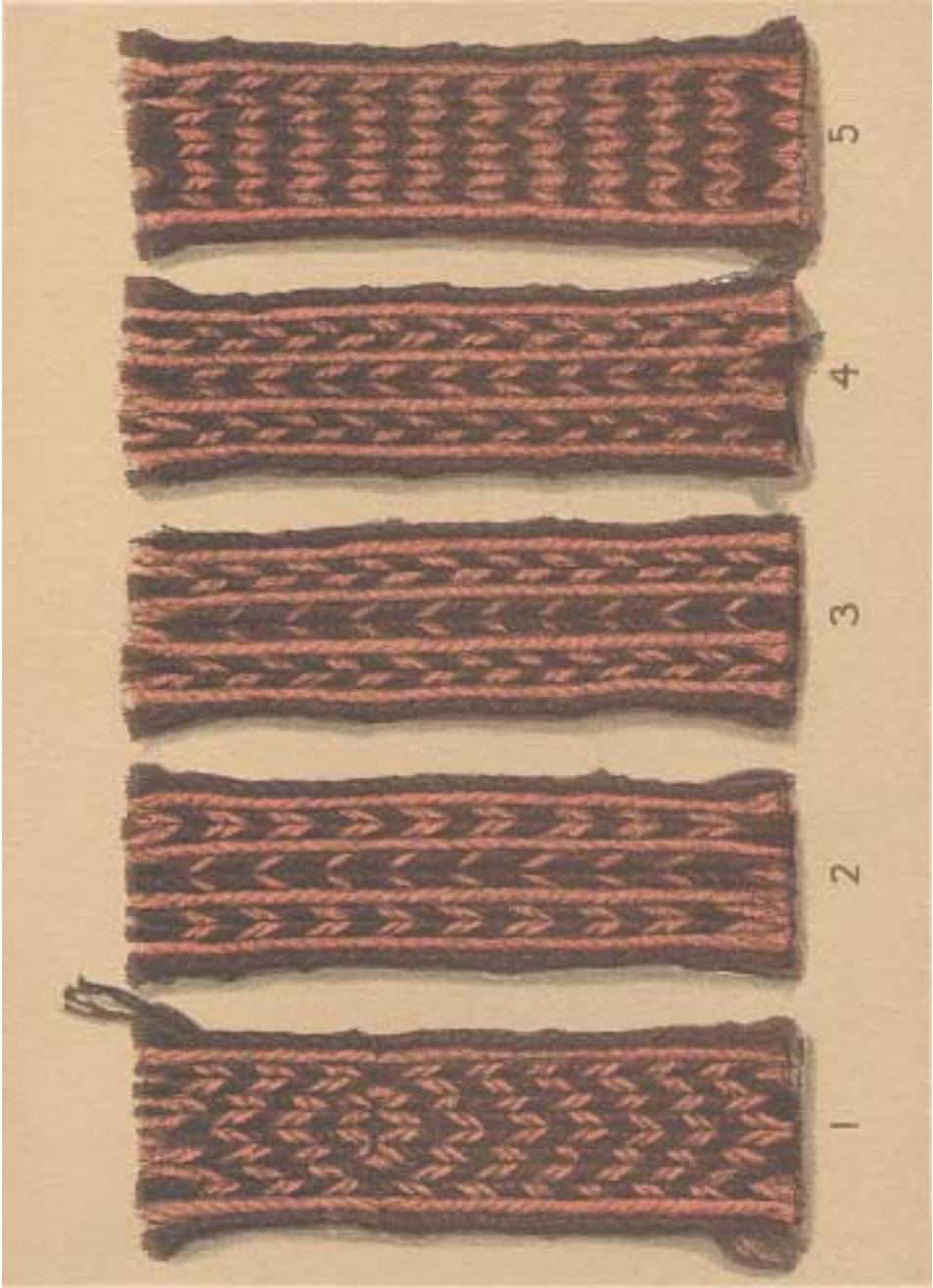

WEAVING
WITH SMALL
APPLIANCES
WRITTEN & ILLUSTRATED

BY

LUTHER HOOPER

DESIGNER AND WEAVING EXPERT ; AUTHOR OF " HAND-
LOOM WEAVING, PLAIN AND ORNAMENTAL " ; " SILK " ;
" THE LOOM AND SPINDLE " ; " WEAVING FOR
BEGINNERS," ETC. ; LATE LECTURER AND TEACHER OF
WEAVING AT THE LONDON COUNTY COUNCIL CENTRAL
SCHOOL OF ARTS AND CRAFTS, SOUTHAMPTON ROW,
LONDON

BOOK II — TABLET WEAVING

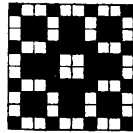

LONDON

SIR ISAAC PITMAN & SONS, LTD.
PARKER STREET, KINGSWAY, W.C.2
BATH, MELBOURNE, TORONTO, NEW YORK

1923

PRINTED IN GREAT BRITAIN
AT THE PITMAN PRESS, BATH

CONTENTS

CHAP.	PAGE
INTRODUCTION	I
I. HOW TABLET WEAVING DIFFERS IN PRINCIPLE FROM WEAVING ON THE BOARD LOOM, AS DESCRIBED IN BOOK I	3
II. THE TABLETS AND THE WEAVING STAND	6
III. THE WARP AND HOW TO MAKE IT	12
IV. FIXING THE WARP ON THE LOOM AND MOUNTING THE TABLETS	21
V. THREADING THE TABLETS	24
VI. YARNS SUITABLE FOR USE IN TABLET WEAVING	31
VII. BEGINNING TO WEAVE BRAID	33
VIII. ORNAMENTAL WEAVING WITH TABLETS	41
IX. DESIGNS OF COLOURED STRIPES	43
X. DESIGNS OF CHECKERS OR DICE PATTERNS	47
XI. DESIGNS OF CHECKERS MIXED WITH PLAIN VERTICAL STRIPES	51
XII. DESIGNS ON PLATE IV AND THE FRONTISPIECE EXPLAINED BY MEANS OF PLATE V	54
XIII. DIAGONALS AND CHEVRONS	58
XIV. REVERSING	64

ILLUSTRATIONS

FIG.	PAGE
1. A Tablet	6
2. Front view of Tablets	7
3. A Tablet Loom complete	8
4. Back board of Loom	9
5. Front board of Loom	10
6. Connecting board of Loom	11
7. Warping board, description A	14
8. Warping board, description B	14
9. Warping board, description C	14
10. Course of Warp on board	15
11. Course of Short Warp on board	15
12. Warp on board	15
13. Warp with Cross taken fourfold	17
14. Bobbin stand	17
15. A Finished Warp, one end Unsecured	19
16. A Finished Warp, one end Secured	19
17. A Warp ready for the Loom	12
18. Warp entering, first position	22
19. Warp entering, second position	24
20. Warp entering third position	25
21. The Cross in the Warp	26
22. Warp entering, fourth position	26
23. Cutting the Loop of Warp ends	27
24. Tablets in Position for entering the Warp	27

FIG.	PAGE
25. Order of entering threads in Tablets	28
26. Warp entered in the first Tablet	29
27A. Warp entered in the Bundle of Tablets	29
27B. One Set of threads entered in Back board	29
28. A lead weight	30
29. Front elevation and perspective view of an entered Tablet	33
30. Tablet, showing Left turn	34
31. Tablet, showing Right turn	34
32. Perspective view of mounted Tablets	35
33. Implements for holding weft	38
34. Weft wound on notched stick	38
35. Diagram of twisted cords, right and left	39
36. Effect of Tablets arranged in pairs	41
37. Warp ready for use	45
38. Tablet entered with different coloured threads	48
39. Effect of two-colour twist	48
40. Effect of right and left turns of Tablets	49
41. Braid on fifteen Tablets	51
42. Braid on seventeen Tablets	51
43. Braid on thirteen Tablets	51
44. Entering of Tablets for smallest checker	52
45. Entering for smallest spot	52

COLOURED PLATES

PLATE	FACING PAGE
Braids Woven on Eight Tablets in Two Colours	<i>Frontispiece</i>
I. Designs consisting of various Coloured Vertical Cords of from 12 to 25 Tablets	44
II. Various Checkers resulting from Different Placing of Tablets threaded as in No. 1 of the Plate	48
III. Specimens of Woven Braid Nos. 1 and 4. Threaded as in Plate II, Nos. 2 and 3, with special Threading and Reversed Turning	51
IV. Designs of Checkers and Vertical Stripes for Narrow Braids	53
V. Diagram of all the Possible Threadings and Positions of Tablets and their Effects on the cords of Woven Braids	56
VI. Designs of Diagonals, Chevrons, and Vertical Lines	59
VII. Braids showing effects Woven from Nos. 2, 5, and 6 of Plate VI, also effect of Reversing in Nos. 1 and 5, Plate VII	64

TABLET WEAVING

INTRODUCTION

MANY years ago I was shown, by the keeper of the Ethnological Department of a provincial museum a little bundle of thin squares of bone, having holes perforated at their four corners, through which a number of hopelessly entangled threads of different colours were passed. I was told that the simple appliance was an ancient, pattern weaving machine of Arabian origin, but that the method of working it was a mystery. I puzzled over the machine for an hour or two but could not solve the problem of the manner of using it, and, being very much occupied at the time, deferred the further study of it to a more convenient season. As usual in such cases the matter passed from my mind and seemed to be entirely forgotten. About four years ago, however, Mr. Kendrick, of the Textile Department of the Victoria and Albert Museum at South Kensington, who is aware of the interest I take in all kinds of weaving, recommended me to see two books in the Art Library which treat of the history and technique of what their authors term *Carton* or *Tablet* weaving, and on doing so I found

Note.—The two books mentioned above are—

1. Ueber Brettchen-Weberei von Margarethe Lehmann Filhés, 1901.
2. Le Tissage aux Cartons et son utilisation décorative dans l'Égypte ancienne, par A. van Gennep et G. Jéquier, 1916.

a more or less lucid description of the method of making braids and laces, of an infinite variety of designs, by means of little bundles of perforated cards such as the Arabian set I then remembered being interested in so long before. From these books we learn that the art of tablet weaving is pre-historic, was very generally used in the ancient world, both Eastern and Western, was practised in Europe in the Middle Ages and the Renaissance, and, that many kinds of beautiful braids and other narrow webs, for various uses, are still woven by this simple method in remote places where the primitive traditional arts and crafts still survive.

My interest in the subject was further stimulated by the very clear representation of the appliance in use which forms the most prominent object in the wonderful tapestry belonging to Rheims Cathedral, which was lent for exhibition, amongst many others, by the French Government two years ago to the Victoria and Albert Museum. In this tapestry the central figure, the Virgin Mary, is depicted weaving an elaborate lace on a tablet loom which stretches across the picture. Since seeing this work I have been studying the technique and capacity of the little appliance with much interest, and the outcome of the experiments I have made I have endeavoured to set forth clearly in the following pages.



CHAPTER I
HOW TABLET WEAVING DIFFERS IN PRINCIPLE
FROM WEAVING ON THE BOARD LOOM,
AS DESCRIBED IN BOOK I

THE student of board-loom weaving, as described in Book I of this series, whether it be tapestry, brocade, or carpet weaving, will agree that all the effects obtainable in that branch of the craft are achieved by pure handwork, and also, that in working, the weaver is at perfect liberty to produce any ornamental forms he pleases, even without making a previous drawing, if he so desires.

All other kinds of weaving are more or less *automatic*, that is, they require definite pre-arrangement not only of the design to be woven but of the order of its weaving. The number of threads to be warped must agree with the repeats of the design as regards width, the lifting of the warp threads, to allow for the intersecting of the weft, must all be contrived beforehand so as to work out exactly line by line and complete one repeat of the design in a certain number of lines. In perfectly automatic weaving all the artist's skill is required in making the *design* and *preparing the loom to weave it*. The actual weaver only turns a handle, manages a treadle or a set of treadles in regular sequence, pulls down certain cords in a prescribed order, or, as will be shown in the following chapters, turns backward and forward a little bundle

of tablets perforated with holes and threaded with various coloured warps.

Of course there are degrees of automatism in different kinds of weaving machines, which vary according to the mechanical perfection to which the loom and its mountings are carried ; for instance, a very simple loom fitted with a pair of treadles will automatically cause even thousands of *warp* threads to rise and fall in such a manner that the necessary intersections with them of the *weft* for plain weaving can be very quickly and easily made. Without this automatic arrangement each alternate thread of warp would have to be picked up separately ; this would take a very long time to do. In such a case the benefit of the automatic lifting is obvious. On such a loom, so fitted with a pair of treadles, the processes of throwing the shuttle and weaving in additional weft ornaments on the plain ground, called *brocading* or *inlaying*, have to be done by hand, and those require as much skill on the weaver's part as do tapestry or carpet weaving.

Automatic arrangements can be, and are, carried to such perfection in some machine looms, that, threads in bewildering order and proportions can be lifted, and numerous shuttles carrying variously coloured threads be kept running in regular succession, so that elaborate designs, after being once set up and arranged for, can be worked out by the mere continuous turning of a shaft and pulley. With such perfect machinery the actual weaver has merely to watch for broken threads and mend them, and to keep the shuttles fed with weft.

Weaving with tablets is so far automatic, as will be presently shown, that many simple-patterned braids and

other webs can be woven by merely turning the set of perforated cards backwards or forwards, according to the design, after the warps have been arranged in a certain order, and the whole warp conveniently stretched on some kind of frame.

CHAPTER II

THE TABLETS AND THE WEAVING STAND

FIG. 1 is a drawing of one of a *set of tablets* which may consist of any convenient number from, say, twelve to fifty. A tablet is simply a square made of some kind of hard material—wood, bone, ivory, or very strong, tough cardboard. The tablet must be very

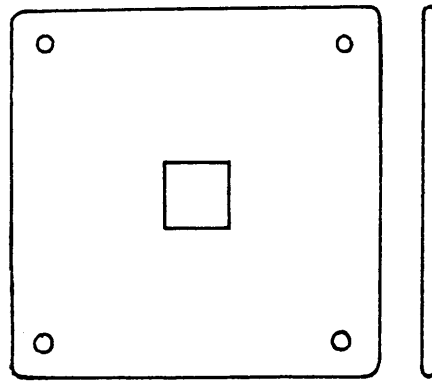

①

thin and smooth, and have all its corners and edges very nicely rounded, so as to retain no points or sharpnesses which would catch and fray any sort of delicate thread which may be used in the braid-making. The tablets may be of any reasonable size, but the most

usual measurement is about two inches square and as thin as possible consistent with strength. The square hole in the centre is half-an-inch in diameter, and the corner holes an eighth of an inch. The corner holes must be circular, very smoothly bored and their edges carefully rounded, so as not to ravel out the thread which

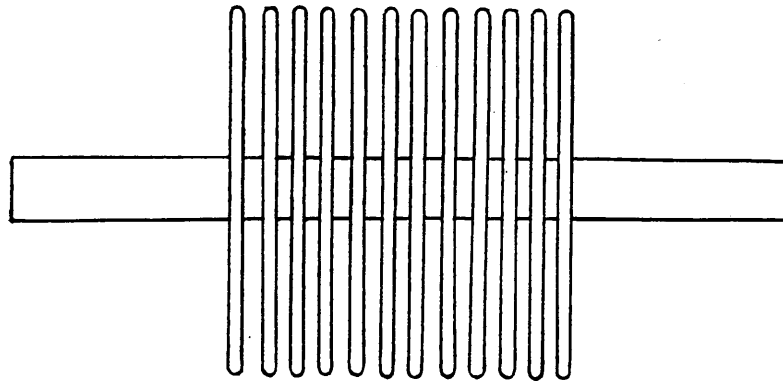

②

is passed through them and is subjected to a good deal of friction as the tablets are turned about and moved backward and forward in the weaving. For first practice a set of twelve tablets will be quite enough for the beginner to manage. The warp for such a set will consist of forty threads, single or double threads as the case may be, four threads for each separate tablet.

For some kinds of weaving a rod which will easily pass through the centre holes of the tablets and keep them in position (*see Fig. 2*) will be required. It will

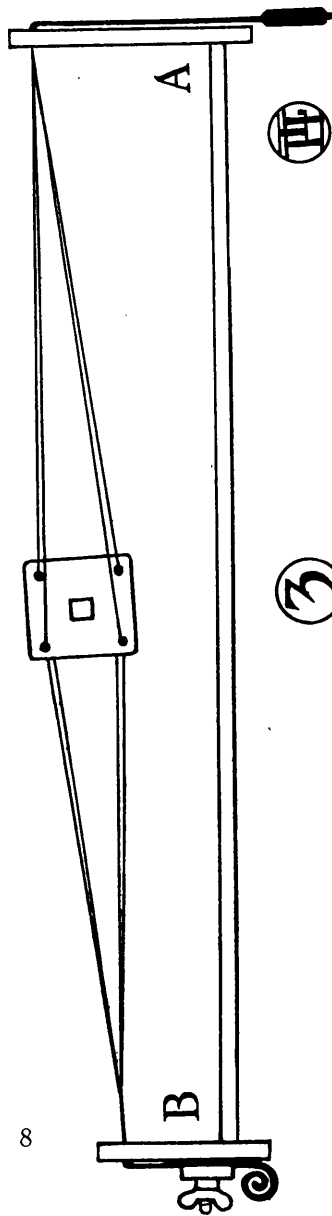

also be useful when threading the warp and mounting it on the stand for stretching it. This stand must next be described. Fig. 3 gives a general view of it with the tablets mounted ready for weaving.

It is quite possible to weave rough kinds of braids by means of the tablets without any frame or mounting whatever, but it is much more convenient to mount them on a portable stand, which will hold them firmly in the position required for weaving and keep them stretched at an even tension.

If no frame is used one end of the warp is fastened to some object which will hold it firmly, and the other—the weaving end—is attached to the belt of the weaver. By this arrangement the tension on the threads required for weaving can be made greater or less by a slight movement of the weaver's body; it is difficult, however, to keep a steady, even tension by this method, and accurate weaving is almost impossible.

The details and measurements

of the stand shown in Fig. 3 are as follows. The stand consists of three parts: Fig. 4, Fig. 5, and Fig. 6.

Fig. 4 represents the most important part of the

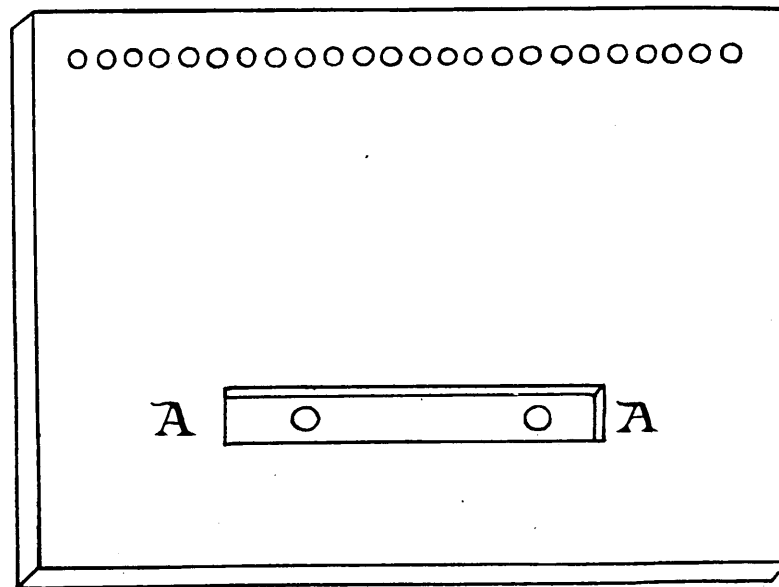

4

stand. It consists of an oblong piece of wood eight-and-a-half inches wide, six inches high, and three-quarters of an inch thick. Half-an-inch from the top edge a row of holes is pierced, the holes being fully eighth of an inch in diameter, and not fewer than three holes

to an inch. The holes must be cleanly bored and perfectly smooth at their edges, like the corner holes in the tablets themselves. Four inches from the top of the board a shallow slot must be cut four inches long, three-quarters of an inch wide, and not more than a quarter of an inch deep. The slot is marked A A in the drawing, and the two holes shown in it are pierced right through

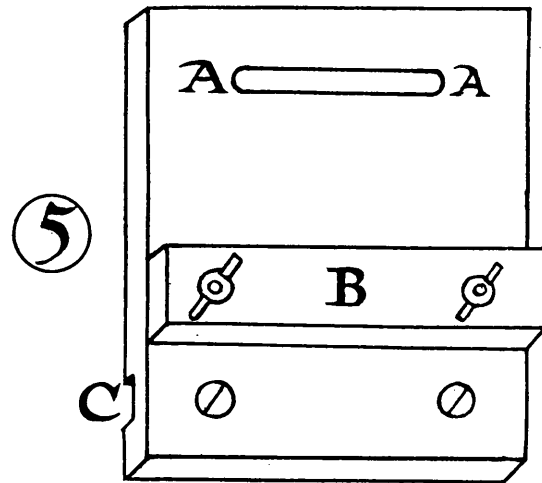

the board. The position of the board in the frame is shown at A, Fig. 3.

Fig. 5 is a drawing of the opposite end of the stand, B, Fig. 3. It is the same thickness as Fig. 4, but is only four inches wide by five inches high. Instead of the row of holes near the top, as in Fig. 4, there is cut in Fig. 5 a narrow slot, A A, two inches from end to end and

three-sixteenths of an inch wide. This slot is cut right through the wood and has also its edges nicely rounded. The attachment B is merely a smooth piece of wood about an inch wide and half-an-inch thick, fixed by wing-nuts so as to fit closely to the surface of the board. Quite near the bottom edge of the board, a groove C is cut to match the slot A in Fig. 4.

Fig. 6 is merely a narrow board four inches wide, twenty-eight inches long, and three-quarters of an inch thick. Its purpose is to join the two ends of the stands (Figs. 4 and 5) together as shown in the sketch, Fig. 3. The ends of the board D D fit into the slots, letters A A, Fig. 4, and C, Fig. 5, and is kept in its place by screws which pass through the holes in the slot, Fig. 4, and by the screws shown in the lower part of the end at Fig. 5.

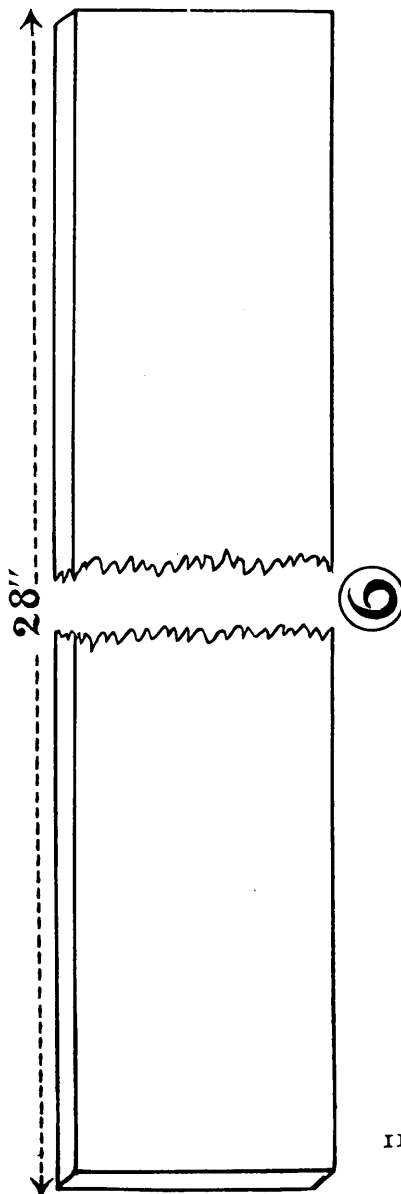

CHAPTER III

THE WARP AND HOW TO MAKE IT

IN all kinds of weaving the preparation of the warp—the threads that run the length of the woven stuff—and the threading, or *entering* as it is called, of it in the loom is a very important operation, and much of the pleasure and success of weaving depends on its being correctly done. It is necessary, therefore, that great care be taken, even with the smallest and simplest warp, to do it evenly and well.

No very elaborate appliance for the making of a warp for *tablet* weaving is required, in fact it can be done without much difficulty on the backs of two or three chairs. What has to be done is to lay an equal length of from about fifty to a couple of hundred threads and take a cross at both ends, between alternate sets of four, to keep them from getting hopelessly entangled. Each set of four threads may be composed of one, two, three, or four different coloured ones, according to the design to be woven.

A little warping board can easily be made on which any length of threads, up to two yards or even more, can be quite perfectly laid. Its construction and the method of using it are shown by Figs. 7, 8, 9, 10, 11, and 12.

Fig. 7 is a half-inch board, seventeen inches long by seven inches high, which can be fixed to some upright surface, such as a wall or door, by means of the two little plates or staples A, B showing at the sides.

Fig. 8 is the same board pierced with twenty-two holes exactly the same size, say, a quarter of an inch. Of course the dimensions and numbers given may vary, but it is best in descriptions of this kind to be as definite as possible, for the sake of clearness. Into each hole, numbered respectively 1, 2, 3, 4, 5, 6, 7, and 8, pegs, such as that shown at C, Fig. 8, are firmly and permanently fixed by being glued in, whilst the holes between pegs 1 and 5, and 4 and 8, are empty.

By the side of Fig. 9, at D, another kind of peg is shown of the same length as C, Fig. 8, but it is of a slightly different shape. Up to half-an-inch from the lower end it is the same thickness as the other peg, and should firmly fit into any of the empty holes without being glued in. The upper part of the peg is thicker, and has a shoulder which rests on the surface of the board when the peg is fitted into a hole. Of these pegs there are four, two for the top and two for the bottom row of holes, and it is clear that they can be fixed in any position desired along the top and bottom of the board.

Fig. 10 is a drawing of the board with the movable pegs arranged in pairs, in such a manner as to make the longest warp possible on a board of this size pierced with this number of holes. Also it will be seen that there is a space of three inches between the two pegs of each pair. The pegs are so placed in order that it may be convenient to make the important crossing of the alternate threads at the *beginning* and the *end* of the length of warp.

Within certain limits it is possible to vary the length of warp with great nicety. If the length of a warp, the course of which is indicated by the dotted line

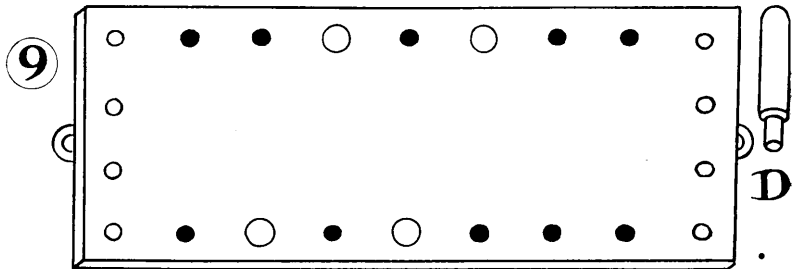
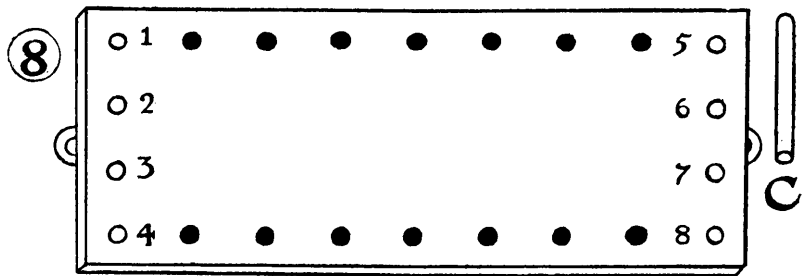
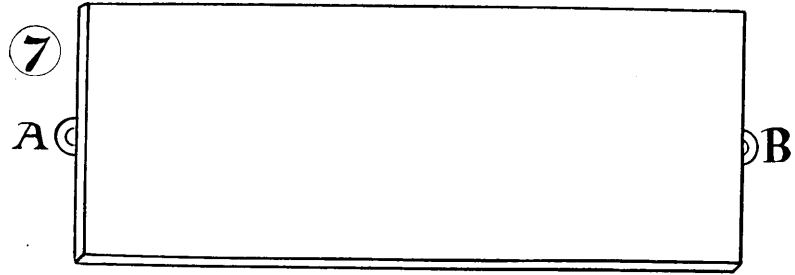

④

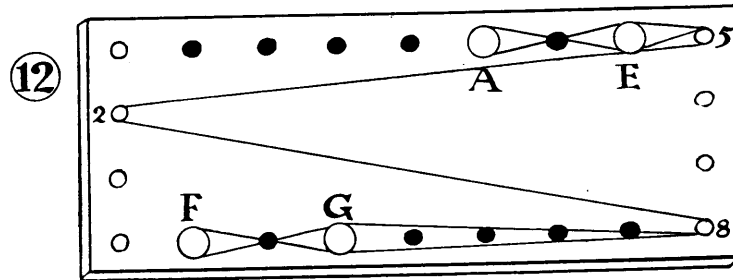
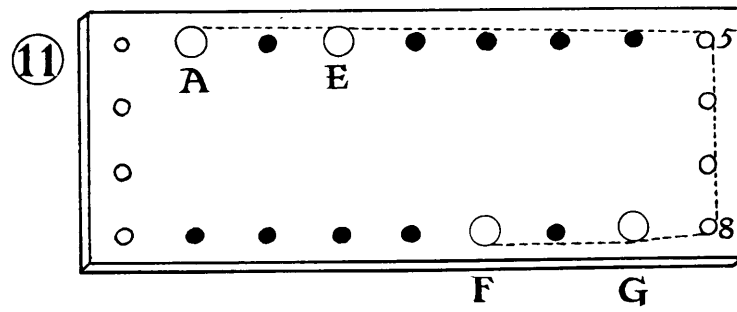
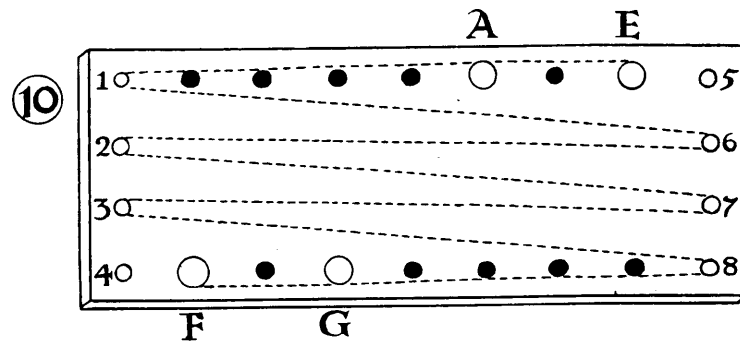

④

running between the pegs E and F, Fig. 10, be calculated, it will be found to measure seven times fifteen inches, less three inches, that is, one hundred and two inches, or eight feet six inches. The line goes from peg E to peg 1, from 1 to 6, from 6 to 2, from 2 to 7, from 7 to 3, from 3 to 8, and 8 to F.

Any shorter length can be arranged by altering the direction of the course from peg to peg and shifting the position of the pairs of pegs A, E, F, and G. Thus from E to 1 and from 1 to 8, then direct to F, will be three feet six inches, whilst from A to E round pegs 5 and 8 will give two feet (*see* Fig. 11). It is not necessary to give more examples as the student can work them out for himself.

At Fig. 12 the board is shown with a warp on it of a convenient length for our first tablet warp, which we will determine to make four feet long. The crossings of the alternate warp threads referred to above are shown between the pegs A and E and F and G. Having been looped on to peg A, the starting point, the thread, or group of threads, was taken *over* peg E, round the fixed peg 5, taken right across the board to peg 2; from peg 2 it was carried direct to peg 8 and round peg 8 as far as the movable peg G. It was taken *over* G, *under* and round F, *under* G, and back in the same course until it reached peg E; it was then taken *under* E and carried *over* and *round* A, which finished the first course as shown at Fig. 12. This course has to be repeated exactly again and again, until as many threads are laid as are required for the work in hand.

Now let us consider what is the simplest braid we can weave on our frame fitted with twelve tablets and then proceed to warp it in the manner just described.

The simplest braid we can weave is, of course, one made with only one colour, perfectly plain, and the same on the back as on the front.

In order to make this braid we shall have to warp forty-eight threads in all for a set of twelve tablets; four threads for each tablet. The cross at each end of the warp

13

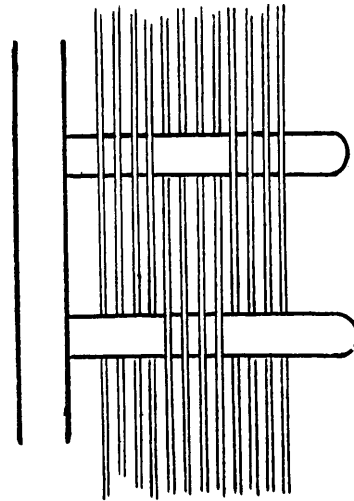

need not be taken between every alternate thread, but between every group of four as shown in Fig. 13.

The little stand (see Fig. 14) will be found convenient for holding the four reels on which the thread for the warp is first to be very carefully wound, as described in Book I,

14

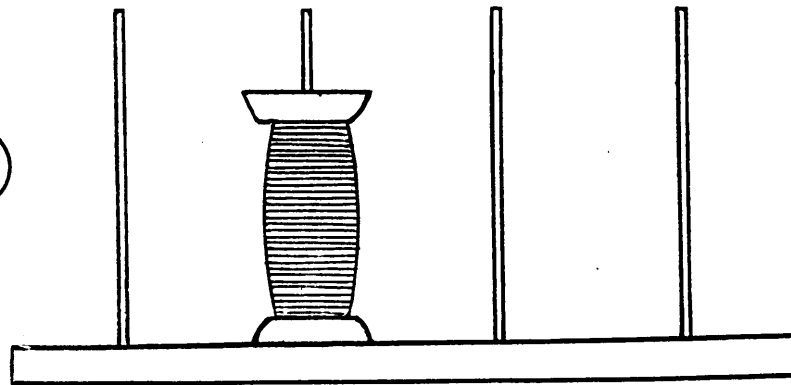

Chapter IV, on board loom weaving. The stand is merely a flat board with four stout wires fixed upright in it about two inches apart. In order to make it stand quite firmly, it must be fixed by a small clamp to the edge of a table. The reel stand, with the reels on it, must be placed in a convenient position a little to the left of the warping board, wherever it is fixed, and, the ends of the four threads being tied together, they must be divided into pairs and be looped over peg A, Fig. 12, one pair passing *over* and the other pair passing *under* it. The two threads passing under peg A must then be passed *over* peg E, and the two from above peg A must be carried *under* peg E, thus making a cross of double threads between pegs A and E (*see* Fig. 15).

This is the most convenient way of beginning and ending the warp because it saves unnecessary knots, but all the intermediate crossings are between alternate four threads, as shown in Fig. 13.

The first cross being made, the four threads are carried together, great care being taken not to twist them, over peg 5 and then follow the same course as that indicated in the diagram, Fig. 12. When the four threads reach peg G they must go *over* it, *under*, *round* and *over* peg F, *under* peg G, and so back in the same course to peg E, which they must all go *over*, then *under*, *round* and *over* peg A and start the next course by going *under* peg E.

Six times forward and six times backward, passing along the same course, will lay the forty-eight threads required for our set of twelve tablets, so that after the sixth return the four threads are to be divided into pairs as at the beginning, and when these threads are crossed, cut off, and tied together behind peg A, the warp is

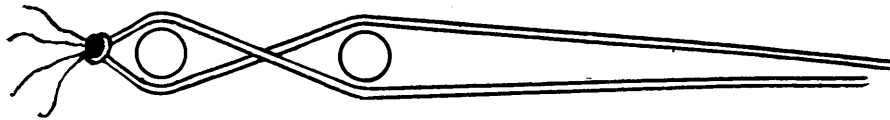

15

finished and it only remains to secure the crossings and remove it from the warping board.

The crosses can be easily secured in the manner illustrated by Fig. 16. As the two ends of the warp are alike they will naturally have to be secured in the same way.

In Fig. 16, A A, are the movable pegs, A, E, F, and G, Fig. 12, with the crosses in the warp between them, the warp being represented by the thick line. B is a short length of strong thread or cord, an end of which has been put in the opening at the front by the side of the peg at C, and brought through from the back of the cross by the side of the other peg at D. After making sure that the thread was clearly through each opening with the pegs, the operator tied the ends firmly together as at E. It

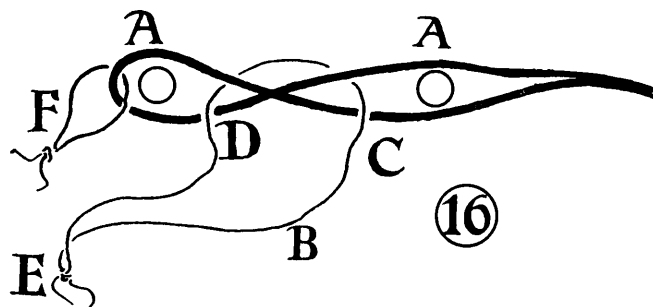

will at once be seen that this effectually secures the cross. In the same opening as the cord passed through at D, but on the other side of the peg, a shorter piece of cord F is also passed and its ends tied together. This has nothing to do with the cross, but is useful in handling the warp when it is removed from the board, and it requires to be just as carefully done.

It should, perhaps, be added that Figs. 15 and 16 represent both ends of the warp when finished.

CHAPTER IV
FIXING THE WARP ON THE LOOM AND
MOUNTING THE TABLETS

WHEN the warp is taken off the board it should be wound on to a reel, care being taken to wind it evenly and to prevent its being twisted (*see* Fig. 17).

Fig. 18 shows the tablet frame ready for mounting. In fact the mounting has just been started by the drawing

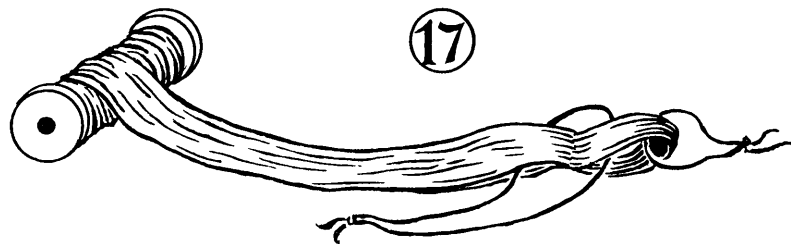

of the loop F through the slot A A in the end board. The holder B has been removed, and the cross-loop F and the end loop E have been drawn through with the warp end. A small rod, four inches long and about a quarter of an inch thick, will now be required for fixing the warp in its place in the end board and preventing its being drawn through the slot A A when tension is given to the threads. The rod must be placed in the opening kept by the loop E and the part of the loop F. When

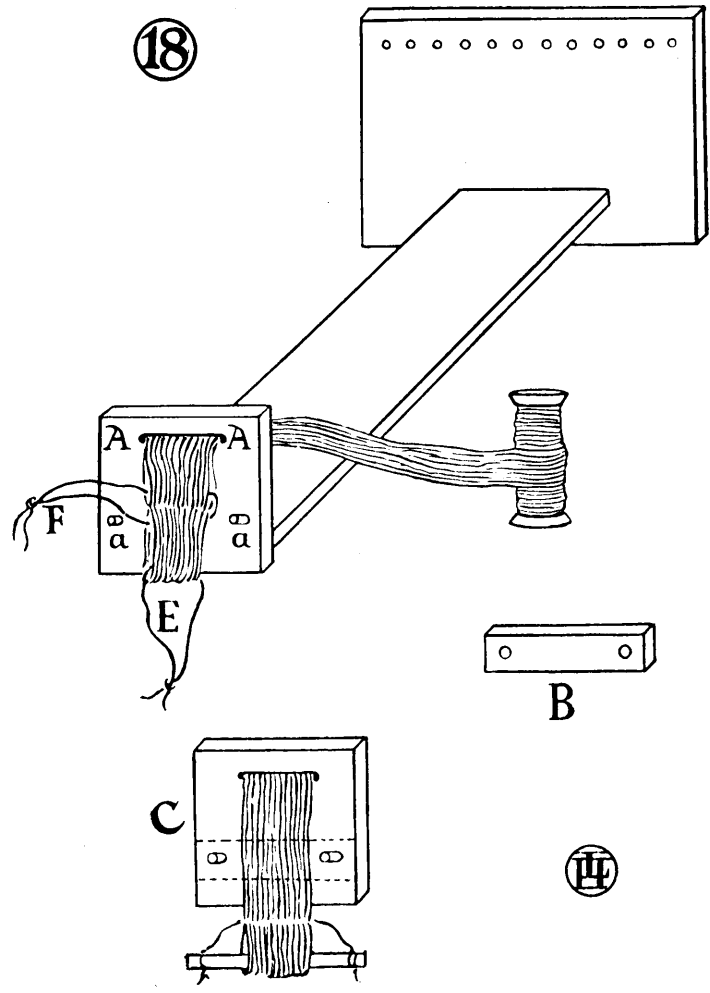

the rod is in the opening the loop E must be removed and the knot at the ends of the cord which forms loop F cut off or untied. The half of the loop F which remains in the opening with the rod must be then drawn out and both ends of the cord tied firmly to the ends of the rod. It will now be possible to arrange the warp end as shown at C, Fig. 18, and the bar B, Fig. 18, can be fitted on the screws a a and fastened down by the wing-nuts, leaving the rod below it, thus effectually preventing the warp end being drawn through the slot A A in the end board. The dotted line C, Fig. 18, shows the position of the bar B, when it is fastened down. Before the bar is tightened the rod must be drawn close to it.

Having thus secured one end of the warp the next thing will be to thread and mount the tablets. This is such an important part of the work that it must have a chapter to itself.

CHAPTER V
THREADING THE TABLETS

It is probable that other ways of threading the tablets than the one set out and described below, varying in unessential details, will suggest themselves to the student as experience in setting up the loom is gained by practice ; but a description of one method of proceeding will be sufficient for the purpose of indicating the

①9

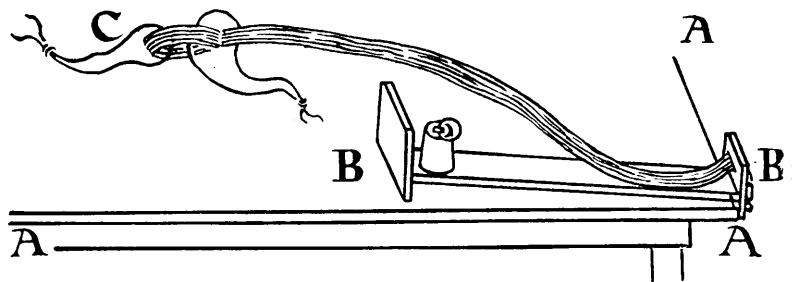

points which are essential to observe, and the errors which must be avoided in the process, whatever exact method may be found most convenient in the end.

Letters A, A, A, Fig. 19, indicate the corner of a table seen from above, on which the mounting is to take

place, and between letters B and B the loom is represented at the stage of mounting at which we left it in the last chapter, that is, with the end of the warp fixed in the slot of the board where the weaving is to begin.

Fig. 20 is the side elevation of Fig. 19: it shows clearly the manner in which the loom is held firmly to the table. The perforated end board at B has a fairly heavy weight placed near it on the back board, and that at B₁ laps over the edge of the table and prevents the loom being pulled in the direction of the letter C. The

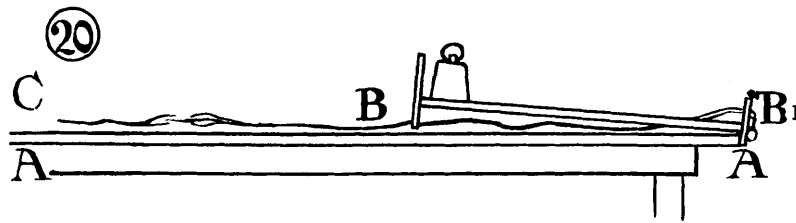

warp is shown lying loose, but flat and untwisted between B₁ and C in both drawings.

The end loop C in the warp must now be taken in hand, and the cross loop being spread out, two little sticks must be inserted in place of the string, which keeps the warp threads divided into separate groups of four. The sticks are for the purpose of making the cross quite clear as in the drawing, Fig. 21.

Fig. 22 shows the next stage of the process of mounting. Here the sticks, after being tied together at their ends, have been slipped along the warp with the cross between them as far as D, and a heavy book has been placed near the end of the warp so as to hold it firmly down to the table.

In order to draw each set of four threads out in regular order for entering in the tablets it will be necessary next to separate the ends of the threads. This will be done

21

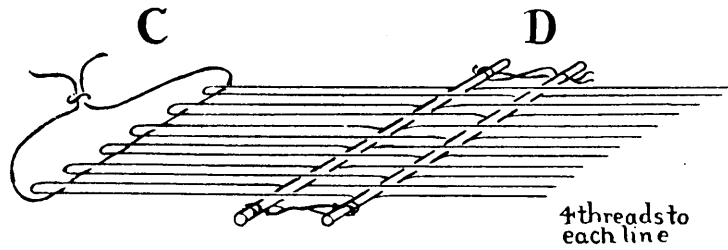

22

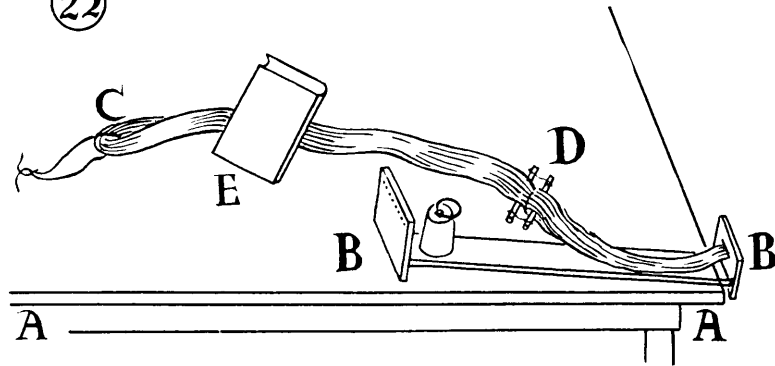

by cutting through the loop of threads at C. This is clearly shown at Fig. 23, A and B. All preparations are now made and the entering of the tablets may begin.

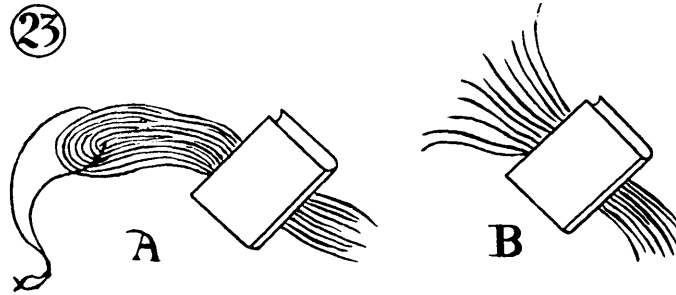
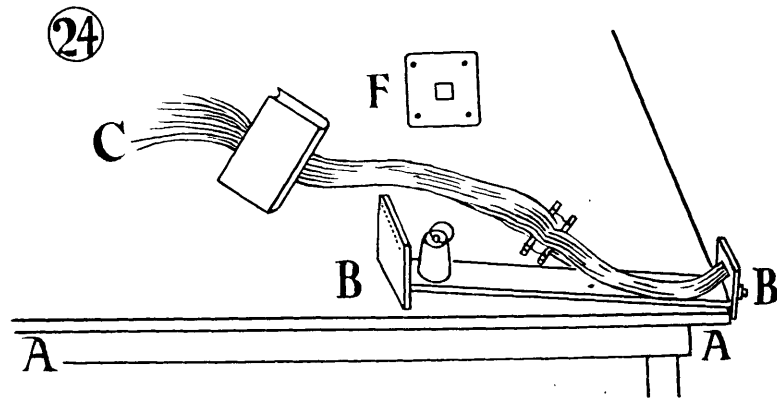

Fig. 24 is exactly the same as Fig. 22, except in two particulars. In this drawing the ends of the threads at C have been separated as shown at B, Fig. 23, and the first of the bundle of tablets (letter F) has been placed near at hand for entering.



In Fig. 25 two tablets (A and B) are shown side by side. A is unentered and B has been threaded with the first four threads drawn from between the cross rods at D, Fig. 22, one thread being passed through each hole at the corners in the order shown by the numerals 1, 2, 3, and 4, letter A.

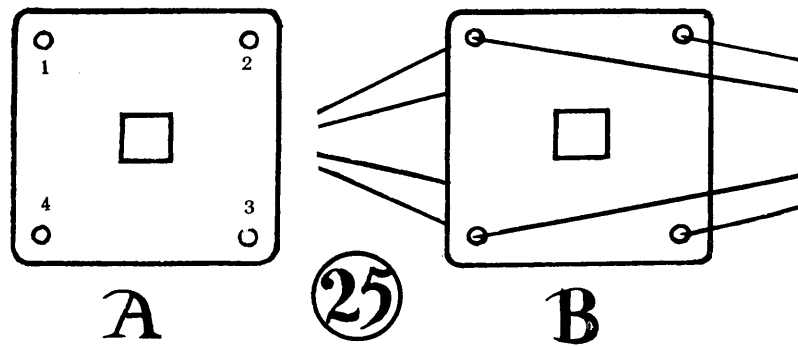
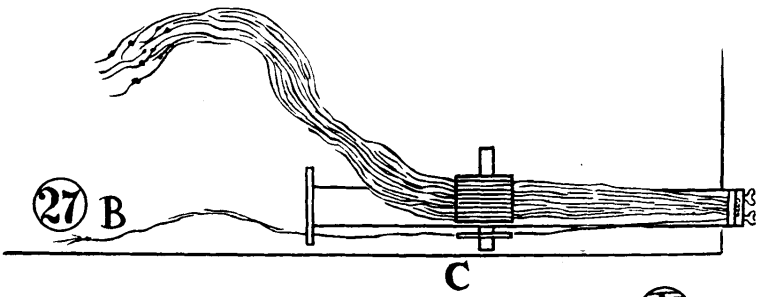
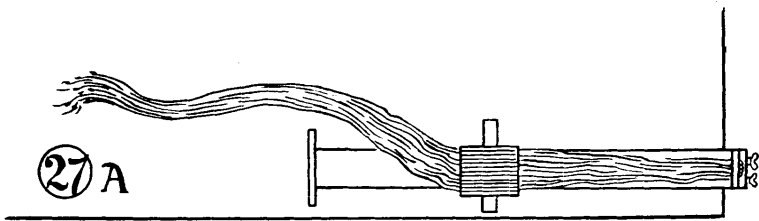
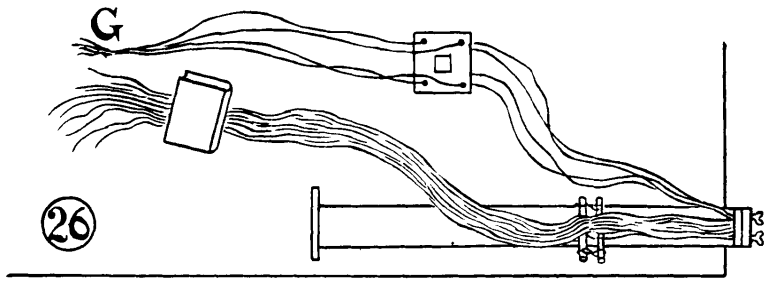

Fig. 26 is the same as Fig. 24, with the addition of the first tablet of the set entered and laid ready to receive the rest of the tablets, as, in succession, they are entered and laid on one another till the pile is complete. They must all be entered in *exactly the same way* and, as each set of four threads is drawn through, the ends must be tied together by a single knot as shown at letter C, Fig. 25. The pile of entered tablets being complete, the two sticks, which have kept the cross in the warp, can be put away for future use. The pile of tablets must now be taken fo hand and the short stick, shown in position in Fig. 2, must be passed through the centre hole so as to hold them in position, all together, near the centre of the loom, as at C in Fig. 27.



Ⓜ

At letter A (Fig. 27) the warp ends, between the tablets and the top board of the loom, are shown loose but securely tied together in separate groups of four, each group being connected with a separate tablet.

At letter B the first tablet (near C) has been pushed along the stick a little way, and the knotted end of the group of four threads connected with it has been passed through the hole at the end of the board; it has been left for the present loosely hanging there. The group from the second tablet has now to be passed in like manner through the next hole, and so on, hole by hole, the tablets must be connected with the top board until all the warp is entered.

The next thing necessary is to give tension to the warp sufficient to enable the weaver to beat the weft up evenly when the work commences. This is to be done by hanging on to the group of threads coming from each tablet a little lead weight (Fig. 28) weighing about four ounces. The purpose of this separate weighting for each tablet will be obvious where the work is in progress. It is a very great addition to value of the tablet loom, although it has not been made use of before to the author's knowledge.

Fig. 3 may now be again examined, as it is a drawing of the loom complete and ready for work to commence on it.

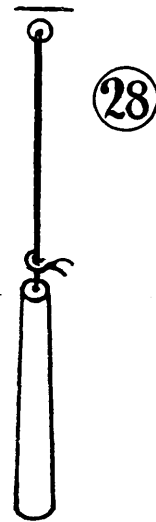

CHAPTER VI
YARNS SUITABLE FOR USE IN TABLET
WEAVING

IT is a great matter in all kinds of weaving to select exactly the right sort of yarn for the work we are about to commence ; but especially is this the case in tablet weaving, in which the warp is of the greatest importance.

For this work the warp thread must be firm, strong, smooth and pliable, so as to bear without fraying the friction caused in the four corner holes of the tablets by the continual turning which they have to bear as the weaving proceeds. Smooth, clean thread is also necessary in order to bring out clearly the ornamental pattern, which depends on the distinct contrast of two or more threads, of different colours, being twisted together with great regularity in each cord of the braid.

Rather coarse net silk, spun silk, or good mercerized cotton, all of which can be purchased in small quantities ready dyed, are the best yarns to use for tablet warps ; they must be well spun and have plenty of twist, in order to make them strong. Wool yarn, on account of its soft and fluffy nature, is not so generally suitable for tablet weaving, although if it be very highly spun and made smooth by being carefully gassed, it can be used with advantage for thick, coarse work.

Linen thread is the least suitable of all for tablet warps because of its harsh and uneven nature.

The colours of the yarns used in this branch of weaving are of the utmost importance ; they require to be *bright and strong* so as to tell out clearly in the designs, which for the most part consist of thin lines and minute spaces of contrasting colours.

The thread for the weft, in tablet weaving, requires to be strong, fine, and inconspicuous ; it plays no part in the design ; its only office is to bind the cords of the warp firmly together. It should only be seen at the edges of the braid and then only as a tiny speck. It is best as a rule to choose weft of the same colour as the *edge threads of the work*.

CHAPTER VII
BEGINNING TO WEAVE BRAID

THE loom being set up with suitable warp, as described in chapters IV, V, and VI, preparation for the weaving may begin.

An examination of the tablets must be made in order to see that all the sets of threads enter and pass through them in exactly the same way. (Figs. 29, 30, and 31 will help to explain this point.)

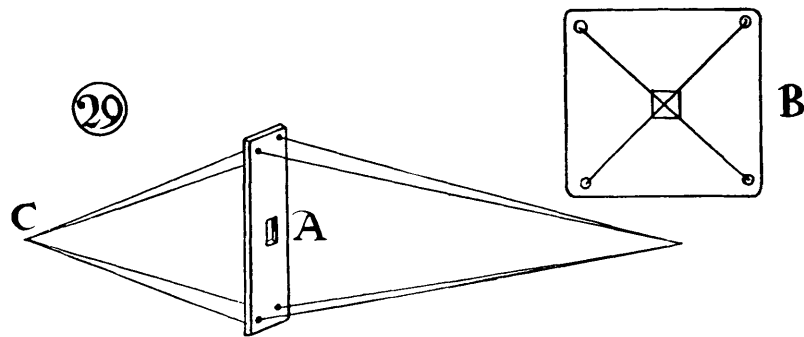
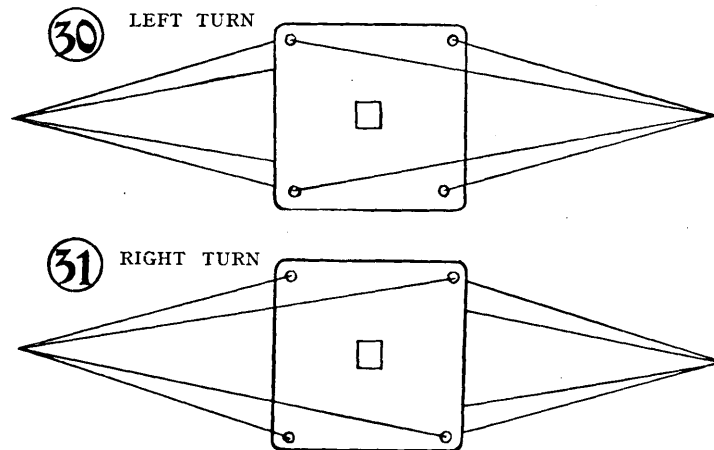

Fig. 29, A, B, and C, shows a single tablet entered with four threads. A is a perspective view of it and B, is a front elevation as seen from letter C. If the threaded tablet A, is to be laid flat so as to take its place in the bundle of twelve, as shown at Fig. 27, Chapter V, and Fig. 3, Chapter II, it must be turned either to the *left*, as in Fig. 30, or to the *right*, as in Fig. 31.

It will most likely be found on examination that some

of the tablets have been turned to the right and others to the left. The first thing to be done, therefore, is to remove the stick from the centre of the bundle and to see, for our first study, that *all the separate tablets are turned in the same direction*: either as in Fig. 30 or 31. When this is done the stick can be replaced and the tablets will be secured in their proper position, as in Fig. 32.



We must pause to note here that the *texture of the web* in tablet weaving, as it is generally done, differs from that of *tapestry* weaving as described in Book I, or ordinary *table loom* or *treadle* weaving to be described in Book III. In both these methods the perfectly straight stretched warp and the straight, though more or less tight, shoot of weft are simply interlaced at right angles, but the texture peculiar to tablet weaving depends on *the warp threads being twisted together* between each throw of the weft; moreover, the weft is generally very inconspicuous and simply binds and holds the twists

together between each turn of the bundle of tablets, whether they are turned forward or backward. The necessary twisting of the warp is effected by turning the

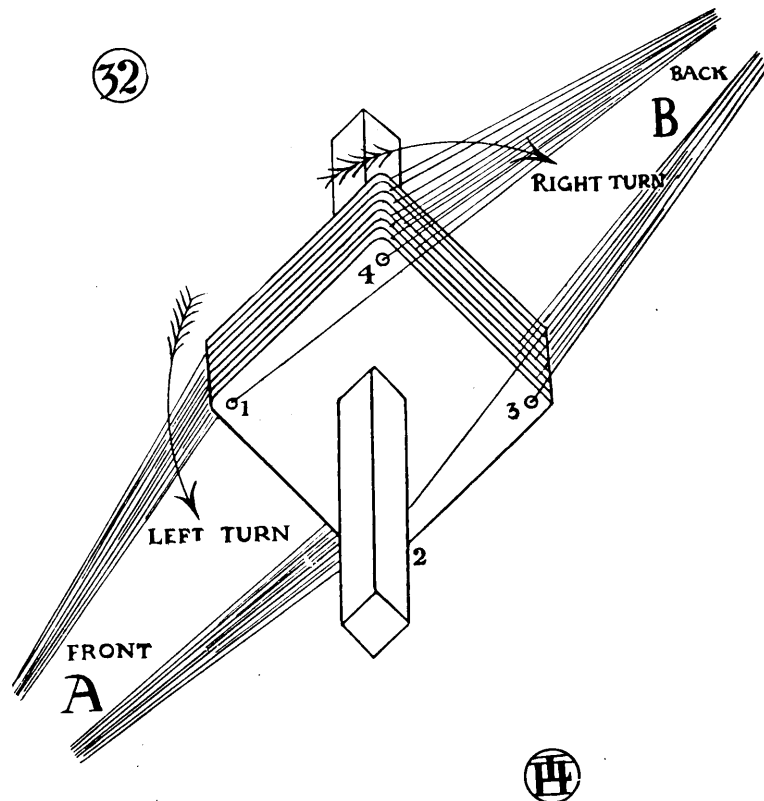

whole bundle over in the direction parallel with the warp threads (see arrows, Fig. 32). Thus, *turning the tablets, one way or the other, a quarter, half, three-quarters, or a whole turn, gives a more or less complete twist to each four threads of the whole warp.* From this description it

will be gathered that tablet weaving is almost entirely a *warp effect*.

The holding stick must now be removed from the centre of the tablets, as otherwise it would interfere with their turning.

In order to make a firm foundation to work upon, we must first weave in, in place of weft, a few slips of thick card or thin wood about a quarter of an inch wide and two inches long ; that is, a little longer than the width of our web. The first slip must be placed in the opening in front of the tablets (*see* Fig. 32A) and then carried between the upper and lower threads till it reaches the front board of the loom and rests in the slot A A, Fig. 5. In Fig. 32 it will be seen that the corner holes of the tablets are numbered respectively 1, 2, 3, and 4, and that if the bundle is turned backward or forward the relative position of all the threads will be changed and a different opening will be made for passing on the slips of card or weft. Leaving then the first slip in its place in the slot, the whole bundle of tablets must be turned a quarter round to the right, that is, towards the back board of the loom ; this will alter the position of all the threads which pass through the four holes. No. 1 will take the place of No. 4 ; No. 4 will take the place of No. 3 ; No. 3 will take the place of No. 2, and No. 2 will be in the first position of No. 1. This quarter turn will make the second opening, into which a second slip of card must be placed and pressed close up to the first one. Another quarter turn in the same direction will bring hole 3 to the top front position and make the opening for the third slip, which must be pressed close to the second. Still another quarter turn, and hole 4 will be at the top front and No. 1 hole will

be at the bottom front ; this will make the opening for the fourth slip of card, which must be also pressed close to the other slips ; and the next turn will bring again No. 1 hole, with its thread, into the first position at the top, in the front. *Thus turning and turning in the same direction a regular succession of openings will be made,* and when in these openings a thread of weft is passed from side to side, a plain braid of *twisted cords* will be woven.

Six slips will be sufficient to make a firm foundation, and when they are pressed up close together weaving with a *weft thread* can begin.

In our first study we must take care that all the tablets turn together and that the bundle is moved only a quarter round, *in the same direction*, each turn.

For introducing the weft a shuttle of some kind will be required ; a flat, short netting needle made of wood or bone makes a good shuttle ; or a tatting shuttle may be used ; but the simplest implement of all is a piece of flat, hard wood about six inches long, half-an-inch wide, and just thick enough to have no tendency to bend.

Fig. 33, A, B, and C, shows these three implements in the order named above.

Fig. 34 shows the shuttle C with the weft wound upon it ready for weaving.

Six slips of card or wood having been woven into their places and pressed close together, the seventh opening must be made in the same manner as for the slips, but into this, from the right-hand side, the weft must be passed by means of the shuttle. Before passing the shuttle through, the end A, Fig. 34, may be tied to the last slip so as to prevent it escaping when the shuttle

is drawn out on the other side of the warp. As soon as the weft is placed in the opening, another quarter turn of the tablets will prevent it springing out after it has been pressed close by the beater. The best implement

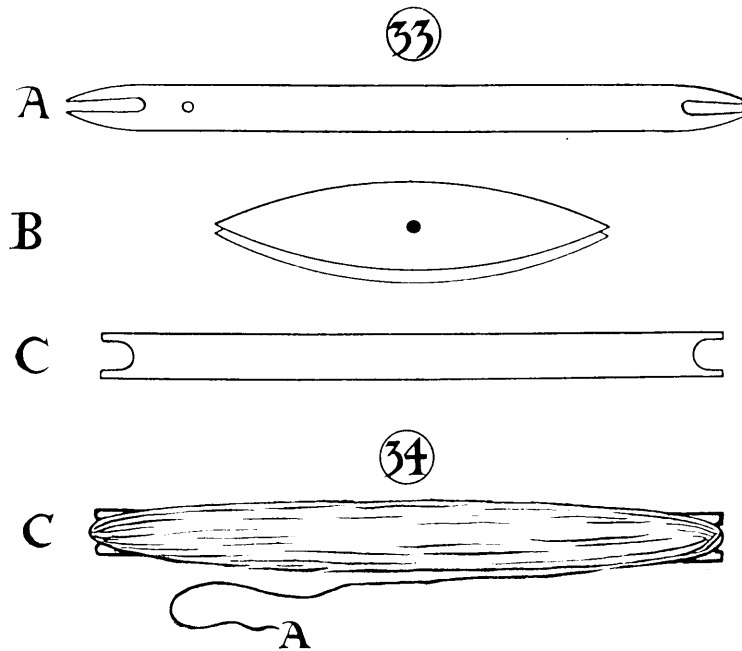

for beating up the weft in tablet weaving is an ordinary smooth paper knife, the knife to be put into the opening after every quarter turn of the tablets, and its edge pressed close to the last laid weft. Care must, of course, be taken to press the weft evenly so that every inch of the braid may contain the same number of weft threads.

The first crossing of the weft being laid, the next opening made, and the weft pressed down, the shuttle

must be returned through the opening from left to right and be drawn just tight enough to bind the warp threads together, but not so tightly as to close them in too much and make the braid too narrow. As soon as the shuttle has been passed six times from right to left and six times

35

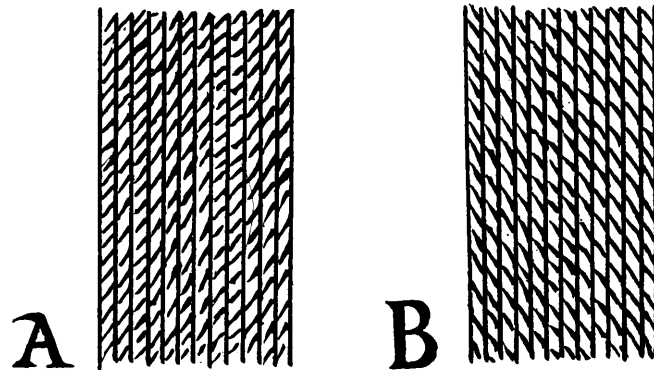

from left to right in twelve successive openings, thus laying twelve lines of weft, a square of braid will be woven, *its size depending on the size of warp thread used.*

Before going on, the weaving must be examined to see that (1) all the warp cords are the same distance apart, and if they are not so, the spacing must be corrected by means of a pointed implement which can be pushed between them in places where they are too close together. (2) By equalizing the weft in the same way; this, however, is more difficult; care must therefore be taken to beat the weft as evenly as possible with the paper knife as soon as it is laid.

Fig. 35, A and B, is a drawing of the effect of this, the simplest form of tablet weaving, viz. with the tablets warped with thread of one colour only and always turning a quarter turn in the same direction either to the right (letter A) or to the left (letter B).

NOTES TO CHAPTER VII

1. The beater must be heavy and be pressed close to the weft immediately after the next opening is made in the warp. It is no use beating the weft before the next opening is made, as it will not stay in its place until held there by the twist of the warp cord.

2. Care must be taken to turn the tablets in one direction only—a quarter turn at a time. If the successive turning brings the bundle into an inconvenient position, it can be corrected by pushing the tablets backward or forward altogether after slightly opening them out to prevent undue friction of the threads. A good weaver keeps the bundle always in the same position by a little push backward at every turn. This movement also helps to regulate the tension of the warp.

3. Always replace the holding stick in the bundle before extra beating down, planning any alteration in the threading or leaving off work. This is in order to prevent the bundle or any separate tablet getting into another position, as they are very apt to do if loose.

4. When the warp becomes twisted on the opposite end to the weaving so as to interfere with the work, as it naturally will, it can be easily corrected by inserting the hand in the opening above the tablets and pushing the twist as far back as the row of holes in the back board; the separate weights connected with each tablet will do the rest.

5. It is well to separate the tablets occasionally and examine them to see that the warp is not entangled so as to prevent a clear opening being made.

CHAPTER VIII

ORNAMENTAL WEAVING WITH TABLETS

AS we have remarked in an earlier chapter, tablet weaving is entirely a warp effect, the office of the weft being simply to bind the fourfold twisted cords of the warp together. This being so, it is obvious that any ornamental designs, whether simple or elaborate, must be arranged for in the threading of the warp or obtained by manipulating the tablets in different ways.

The simplest ornamental effect to be woven is achieved by arranging the tablets in pairs. Figs. 30 and 31, on page 34, will help to illustrate this point. If alternate tablets are arranged so that the left turn of one faces the right turn of the next throughout the pack, the twist of the alternate cords of warp will turn to the right and left as in Fig. 36. This should be compared with Fig. 35, A and B, page 39.

It is quite easy to turn any *one*, or any *portion* of the bundle of tablets, so as to make them work in pairs, as just described. Thus turning the

36

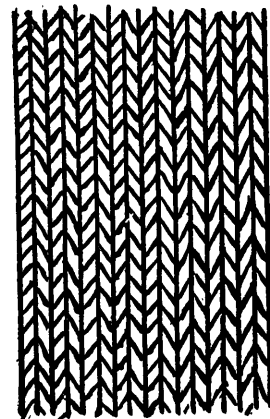

twist of groups of warp threads in one direction or the other will greatly add to the diversity of the braids.

This has been fully described in Chapter VII, but as these points are extremely important in ornamental tablet weaving, the student should re-read that chapter, at the same time making experiments on the loom.

CHAPTER IX
DESIGNS OF COLOURED STRIPES

AS is the case in ordinary weaving, many very beautiful designs can be made in *tablet weaving* by means of using various coloured threads for the warp and arranging them in differing proportions as to number.

This, indeed, seems to be the foundation of all ornamental pattern designs for textile fabrics, and, simple as it may appear, it affords great opportunity for the artist to display his skill and taste.

On Plate I are six examples of stripe designs, the stripes being made up of different numbers of cords of various colours, each cord being composed of four threads of a colour. It will be noticed that the designs of this plate, and all the successive ones, are drawn on ruled or *point* paper, and that each *vertical* row of tiny squares represents a cord of twisted threads, and each *horizontal* row of squares represents a quarter turn of the cord, each quarter turn being separated by a shoot of weft.

Any one of the designs on Plate I would make an effective braid if woven in harmoniously contrasting colours. It must be pointed out here that the colours of thread used for tablet weaving must be fairly strong in contrast, as the edges of the shapes of the ornamental details are not so definite as they are generally made,

for instance, in printing, painting, or even in ordinary weaving.

It is not necessary to describe in detail the warping of all the six examples given on Plate I, but it will be well to give directions for carrying out design No. 4. This explained, the student should be able to prepare the loom for weaving any of the others illustrated, or any designs of a similar character he may invent.

No. 4, Plate I, is drawn on twenty vertical lines. There are sixteen lines to an inch, the most generally convenient size for tablet weaving. Each line represents the twisted cord of four threads entered through each tablet; consequently four threads of warp will be required for every vertical line of the design. The colours of the design are four—green, purple, yellow, and blue—and they are in the following proportions: thirty-two green, sixteen purple, sixteen yellow, and sixteen blue threads. The first thing to do then is to measure off, on the warping board, a sufficient length of thread of each of these colours. It will not be necessary in this case to take the crosses at each end, as described in Chapter III, but the board affords the most convenient means of cutting off the threads exactly the same length and prevents waste. Fig. 37 shows a short warp on the board between pegs A and D.

In the drawing on page 45 a cord with a slip loop is represented between letters B and C. The noose has been drawn tightly round the whole warp at B and the cord has been securely tied to the peg C. The loops of warp can now all be cut at A, thus separating all the threads at that end. The threads at A being cut will make it possible to select any coloured thread at D and draw out of the warp

PLATE I.

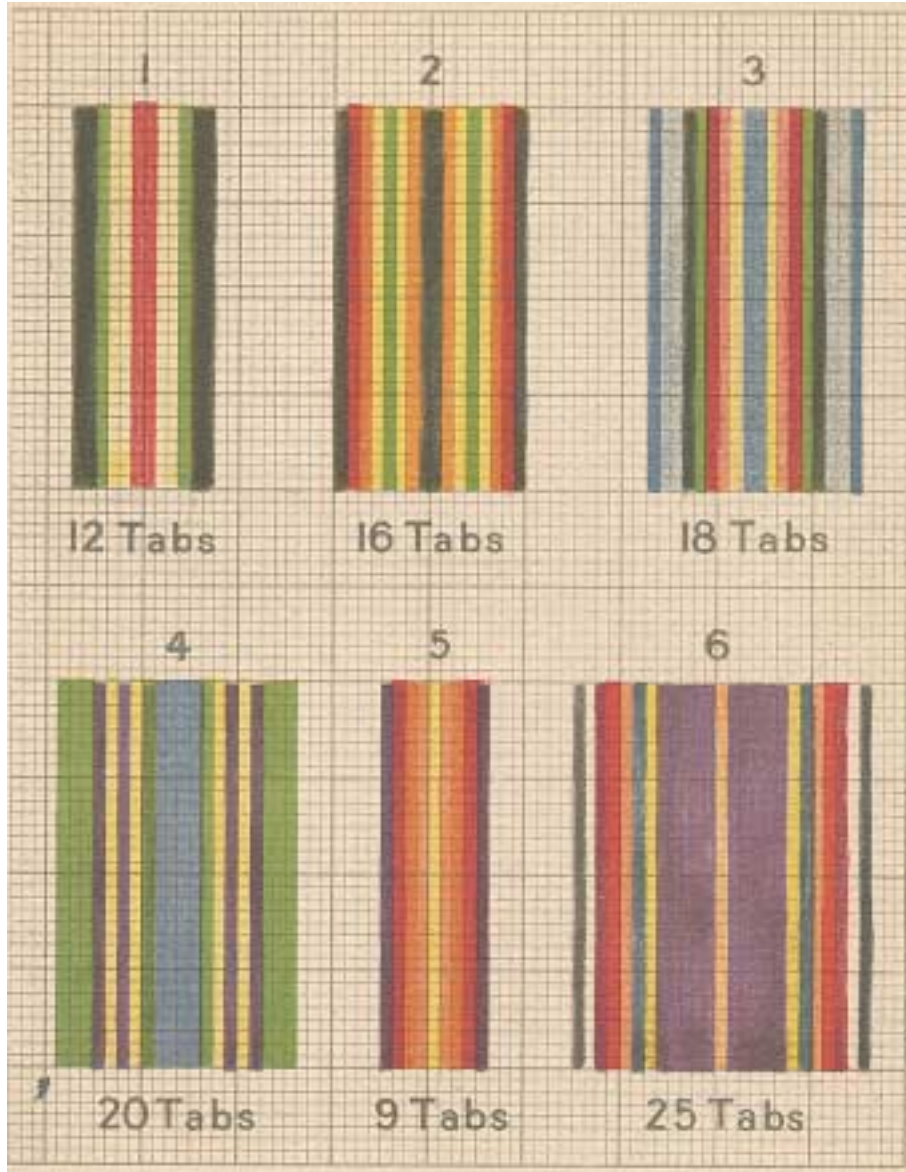

a *double thread of the exact length required* without tangling up the remainder which is securely held by the noose of cord at B.

Referring to our design, Plate I, No. 4, at the left-hand side, we see that tablets 1, 2, and 3 have to be threaded with green warp; we therefore draw out at letter D, Fig. 37, one loop of *light green*, which will give us a double thread. Placing the double thread on a table with the loop hanging over one edge, we take a tablet and

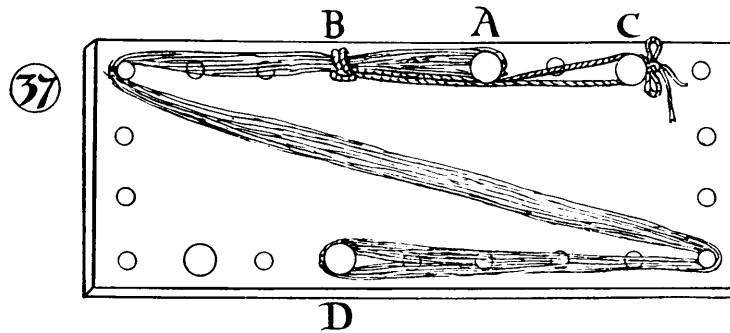

pass the two loose ends of the thread through its two corner holes. A second double thread of the same colour must be drawn out and its ends passed through the remaining holes in the first tablet, which can then be laid flat on the table after the ends of the threads have been securely tied together. (See Fig. 26, page 29.)

The second and third tablets must be treated in the same manner and laid in order on the first one. For the next tablet, No. 4, two loops of *purple* must be drawn out and threaded and the tablet added to the three already filled with green. One tablet of *yellow* threads, then another one of *purple*, followed by another of *yellow*, will

complete the *seventh* cord of the design. The *eighth* tablet is to be threaded with the same colour as the first *three*, and two tablets of *blue* will complete the first half of the design. Beginning with two tablets of blue we have only to reverse the order of threading to finish the design, thus ending with three tablets of *green* as at the beginning.

No other directions for weaving are necessary here ; in fact, for all designs in tablet weaving, except in very special and difficult ones, *the pattern depends entirely on the threading and arrangement of the tablets before the weaving begins.*

CHAPTER X

DESIGNS OF CHECKERS OR DICE PATTERNS

BY far the largest proportion of the traditional designs for tablet weaving consists of diverse arrangements of vertical lines, horizontal bands, and checkers or dice patterns. The threading of the tablets which produces horizontal bands and checkers is the same; the difference between the two effects is brought about by *placing the tablets themselves in different positions in relation to one another.*

The five examples of horizontal bands and checkers illustrated on Plate II are all produced by the same threading, which is shown in Fig. 1 of the plate and Fig. 38, on page 48.

From these drawings it will be seen that each tablet has, entered through its corner holes, two *dark* and two *light* coloured threads numbered 1, 2, and 3, 4. Nos. 1 and 2 are dark and Nos. 3 and 4 are light. If the tablet thus threaded is turned to the left, as directed by the arrow in Fig. 38, a fourfold cord of two distinct colours will be produced; this is shown at A, Fig. 39; but if turned to the *right* the general effect will be the same, but, the twist will be in the opposite direction as at B. This right and left twisting has been fully explained in Chapter VII, but is again mentioned because when two or more colours are used and a design is to be woven,

its importance is greatly enhanced ; it must therefore be quite clearly understood before proceeding further.

Let us suppose a bundle of tablets in the loom thus entered with two black and two yellow threads in each tablet, the *black threads all being at the top*. The weft is passed through while they are in that position, then a quarter turn is given and the weft pressed down ; the weft is returned through the second opening, and, after

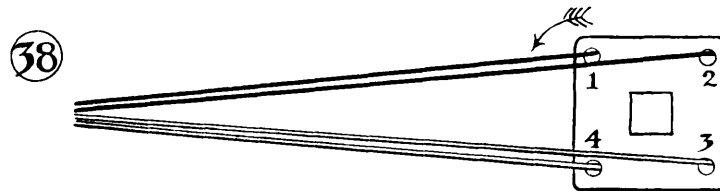

the third opening is made, is also pressed down. The whole loom should now be examined, and it will be seen that the two yellow threads are at the *top* of all the *tablets* and the black ones at the bottom. It will also be found that the two *black* threads of each of the twisted cords show at the *front* of the work and the two *yellow* ones are underneath at the *back*. Proceeding, after two more turns of the tablets the front of the work will show two yellow threads on every cord and all the black threads will be again at the top of the bundle of tablets. If the weaving is continued, always turning

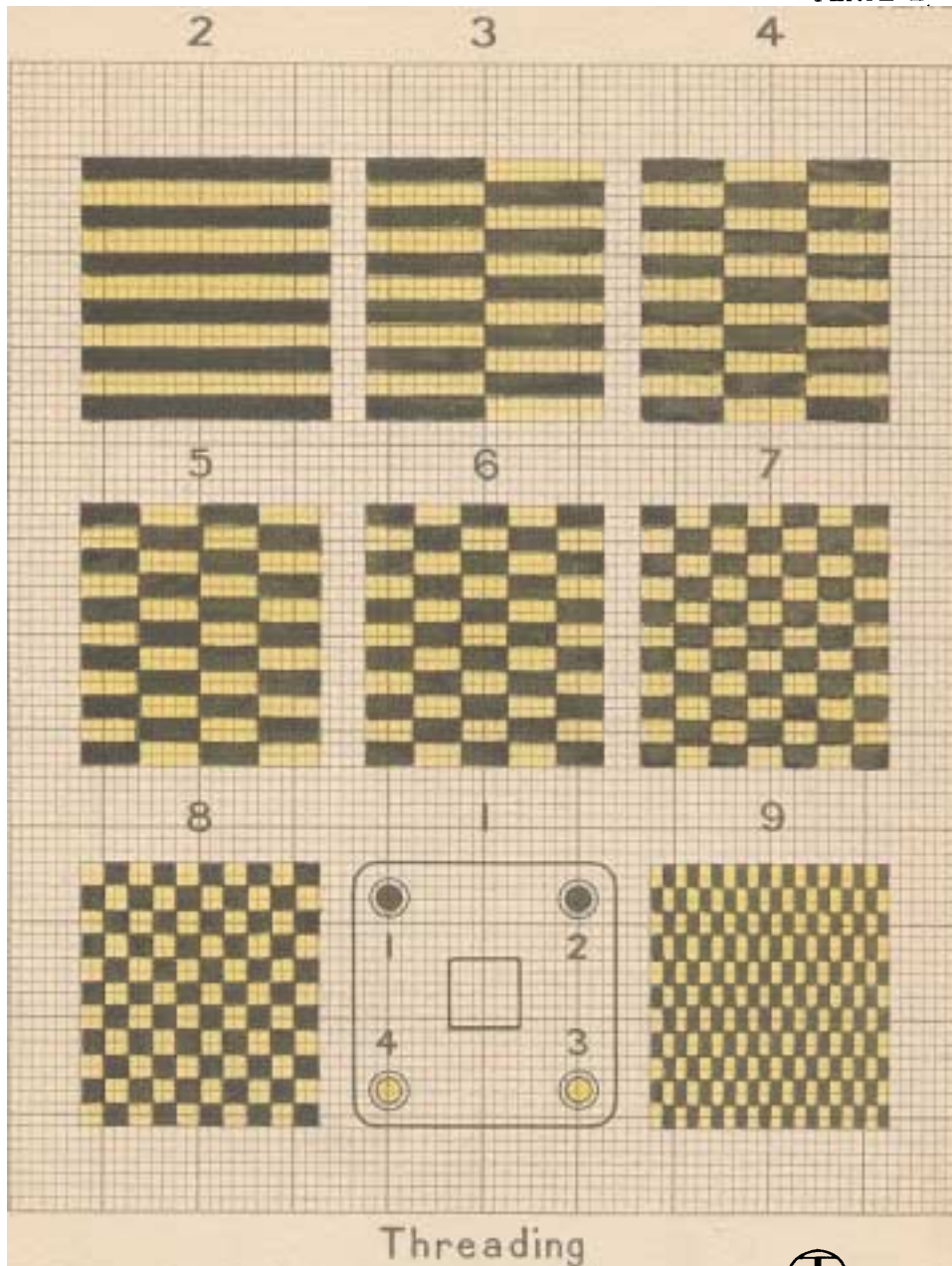

the tablets in one direction, the general effect of No. 2, Plate II, will result.

In weaving this design (No. 2, Plate II) the tablets may be arranged in pairs, as explained in Chapter VIII, or simply with a right or left bias, as described in Chapter VII; the latter arrangement is the better one for the reason stated below.

The student will notice, no doubt, that the horizontal bars are not straight and clear at their edges, as shown on the ruled paper design, but are more or less sharply

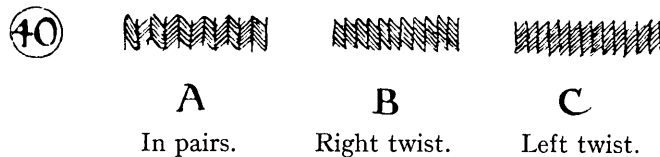

serrated like the cutting edge of a saw. The effect is illustrated by Fig. 40, A, B, and C.

If clear cut bars and checkers therefore are desired the tablets should all be arranged either for the right or left twist, as the *serration* is much less obvious than when they are arranged in pairs. The arrangement in pairs should not, however, be despised, for very many pretty and distinct effects are to be woven by making use of it in checker designs thus arranged.

In order to weave checker designs, such as those of Plate II, the tablets must be arranged in groups before weaving begins, so many with the *dark threads* at the top and so many with the *light threads* at the top. For No. 4, Plate II, for instance, tablets 1 to 7 and 15 to 21 (inclusive) must be placed with the *dark* threads at the

top, but tablets 8 to 14 must be turned so as to have the *light* threads at the *top*. With the tablets so arranged, the weaving can be carried on as before, and the result will be that a checker of dark and light oblongs agreeing with the design will be woven.

The student will now realize that by making the arrangement of the tablets agree with any of the other designs of Plate II, checkers on any number of cords can be woven as easily as a plain web or braid.

It must be noted that although the *width* of the checkers can thus be varied horizontally, the *height* of the checkers still remains the same as *long as the tablets are turned continuously in one direction*. The method of varying the height of the bars or checkers will be dealt with in a subsequent chapter.

The two braids, Nos. 1 and 4, Plate III, show the effect of weaving with tablets all arranged in one direction, not in pairs. No. 1 is a checker made on 2, 4, and 5 cords respectively. No. 4 is made by the same threading, but started with all the green threads at the top and the purple ones at the bottom; Nos. 2 and 3 of Plate III will be referred to in Chapter XIII.

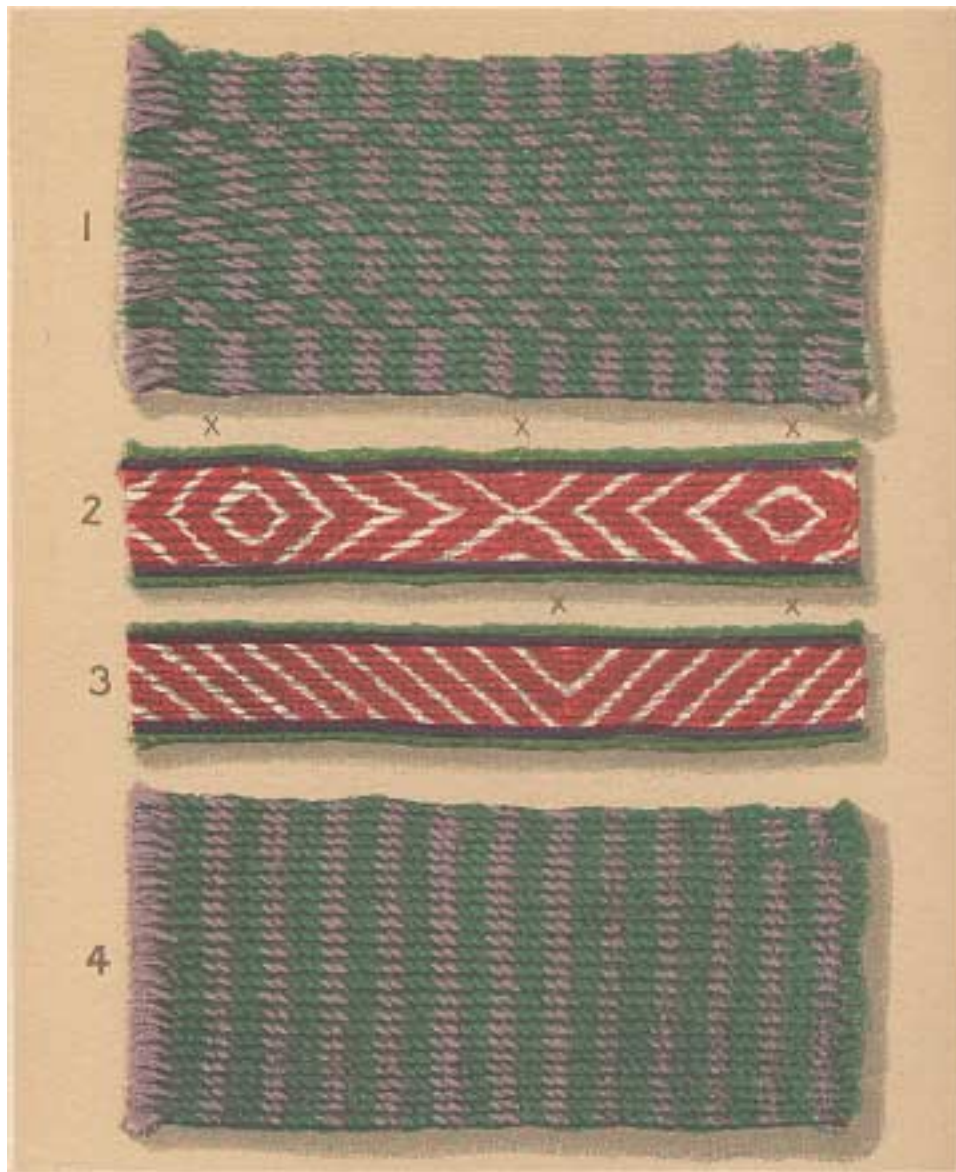

CHAPTER XI

DESIGNS OF CHECKERS MIXED WITH PLAIN
VERTICAL STRIPES IN TWO OR MORE COLOURS

FIGS. 41, 42, and 43, and the eight figures on Plate IV, are all designs for braids to be woven in various checkers and vertical lines or cords, and, with one or two exceptions, they can be woven on twelve tablets. Fig. 43, and Nos. 1, 2, 7, and 8, Plate IV, require, in the

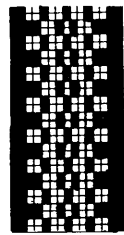

41

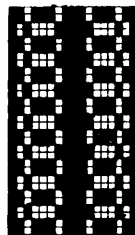

42



43

small checkers, a new threading and placing of the tablets ; this must be explained before any of the designs can be dealt with in detail.

In Fig. 41 the centre stripe is composed of three cords, each cord having alternately two twists of dark and two twists of light thread at the front, making each checker twice as high as it is wide. This should be compared with the centre stripe of Fig. 43, and it will be seen that whilst the checkers of the latter design are the same width, that of a single cord, they are only half the height of

those of Fig. 41. The threading required for this checker is shown diagrammatically in Fig. 44.

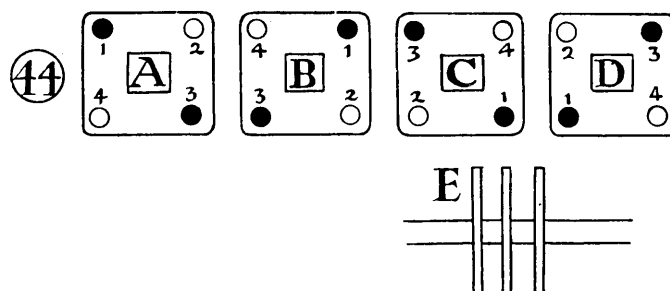

If the three central tablets, shown in position at E thus threaded, are turned with the others continuously in the direction indicated by the letters A, B, C, and D, or in the reverse direction, the result on each cord will

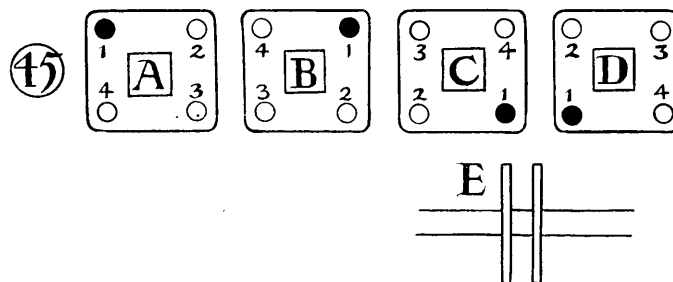

be the smallest checkers it is possible to weave, Fig. 43, etc. Design No. 8, Plate 4, furnishes another variant of a single cord checker in its centre stripe. In this case the tablets are entered with only one dark thread and three light ones, as shown in Fig. 45.

PLATE IV.

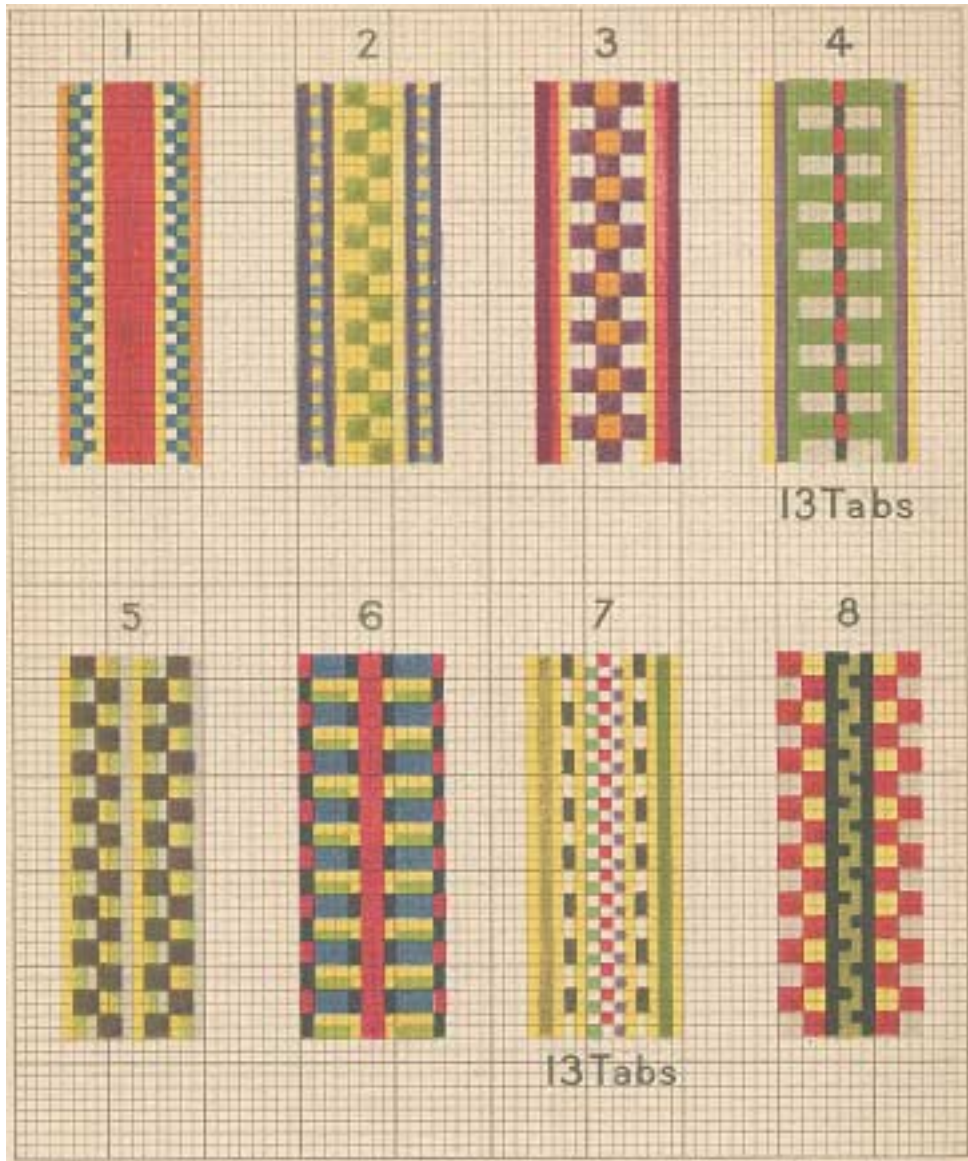

In this design (No. 8, Plate IV) and threading (Fig. 45) it will be seen that the dark thread No. 1 only comes to the top front position once in four turns, as shown in the design.

The effect of the threading of Fig. 45 is also shown in the Frontispiece Plate (Nos. 2 and 3) at their centres. In these cases the tablets are threaded with three darks and one light, and not only arranged in pairs, but so placed that both lights come to the front *together* instead of alternately.

The method of threading and weaving vertical lines has already been explained ; it is therefore only necessary to point out here that the effect of introducing them into the designs is to divide the composition into stripes which give it a pleasant diversity and distinctness of feature.

CHAPTER XII

DESIGNS ON PLATE IV AND THE FRONTIS- PIECE EXPLAINED BY MEANS OF PLATE V

ALL the designs on the Frontispiece and Plate IV, as well as Figs. 41, 42, and 43, are composed of different sized checkers, stripes of various widths, and horizontal bands ; some of them having the tablets arranged in pairs and others singly, they are also all turned together either backward or forward. These materials for composition and arrangements enable the designer to make very rich and effective combinations even with only two colours (*see* Frontispiece) ; but if various colours are used, there is no limit to the number of designs possible even on twelve tablets. Of course if the number of tablets be increased, the scope of the design will be extended and the difficulty of manipulating the bundle of tablets will be proportionally greater. It is said that some expert tablet weavers have been able to work with as many as 250 tablets in a bundle.

The following dissections of designs No. 3 of the Frontispiece, Nos. 1 and 8 of Plate IV, and Fig. 43 will be found instructive and furnish a key for the arranging of any of the others on Plate IV, or of any original designs the student may be able to invent.

On Plate V, Nos. 1 to 24, are given all the threadings and possible positions in a bundle of tablets entered with threads of more than one colour. The effect of most

of these twenty-four can be again diversified threefold by arranging the tablets singly and turning them in one direction or the other, or by placing them in pairs as already described.

The threading and arrangement for starting the braid (No. 3 of the Frontispiece) should be sufficiently explained by the following specification in conjunction with Plate V.

Tablet	Threading	Direction	Colour
I	I	Left	Chocolate
2	2	Right	Orange
3	3	Left	Chocolate and Orange
4	5	Right	Orange and Chocolate
5	2	Left	Orange
6	10	Right	Chocolate and Orange
7	10	Left	" "
8	2	Right	Orange
9	5	Left	Orange and Chocolate
10	3	Right	Chocolate and Orange
11	2	Left	Orange
12	I	Right	Chocolate

It is necessary to note that the numerals in the second column of this and *all the following specifications* refer to the diagrams of threading on Plate V, also that the first tablet always makes the first cord to the left in the designs.

It is interesting to notice the difference between Nos. 2 and 3 of the Frontispiece. The difference results simply from beginning to weave No. 2 design with the third and fourth and the ninth and tenth tablets in the same position, either No. 3 or No. 5, instead of placing 3 and 5 side by side, at the start, as in No. 3 design.

All the tablets being in position, as indicated in

the specification, the centre braid represented in the Frontispiece works out by simply turning the tablets in one direction as usual.

The threadings and positions for starting the tablets of the designs, Nos. 1 and 8, Plate IV, are as follows—

Tablets	Threading	Direction	Colour
1	I	Left	Orange
2	II	„	Green and Blue
3	I2	Right	Blue and White
4	2	„	Yellow
5	I	Left	Red
6	I	Right	„
7	I	Left	„
8	I	Right	„
9	2	Left	Yellow
10	I2	„	Blue and White
11	II	Right	Green and Blue
12	I	„	Orange

SPECIFICATION FOR NO. 8, PLATE IV

Tablet	Threading	Direction	Colours
1	3	Left	Blue and Red
2	3	„	„ „
3	5	„	Red and Yellow
4	5	„	„ „
5	I	Right	Purple
6	I3	„	Black and Green
7	I5	Left	„ „
8	I	„	Purple
9	5	Right	Red and Yellow
10	5	„	„ „
11	3	„	Blue and Red
12	3	„	„ „

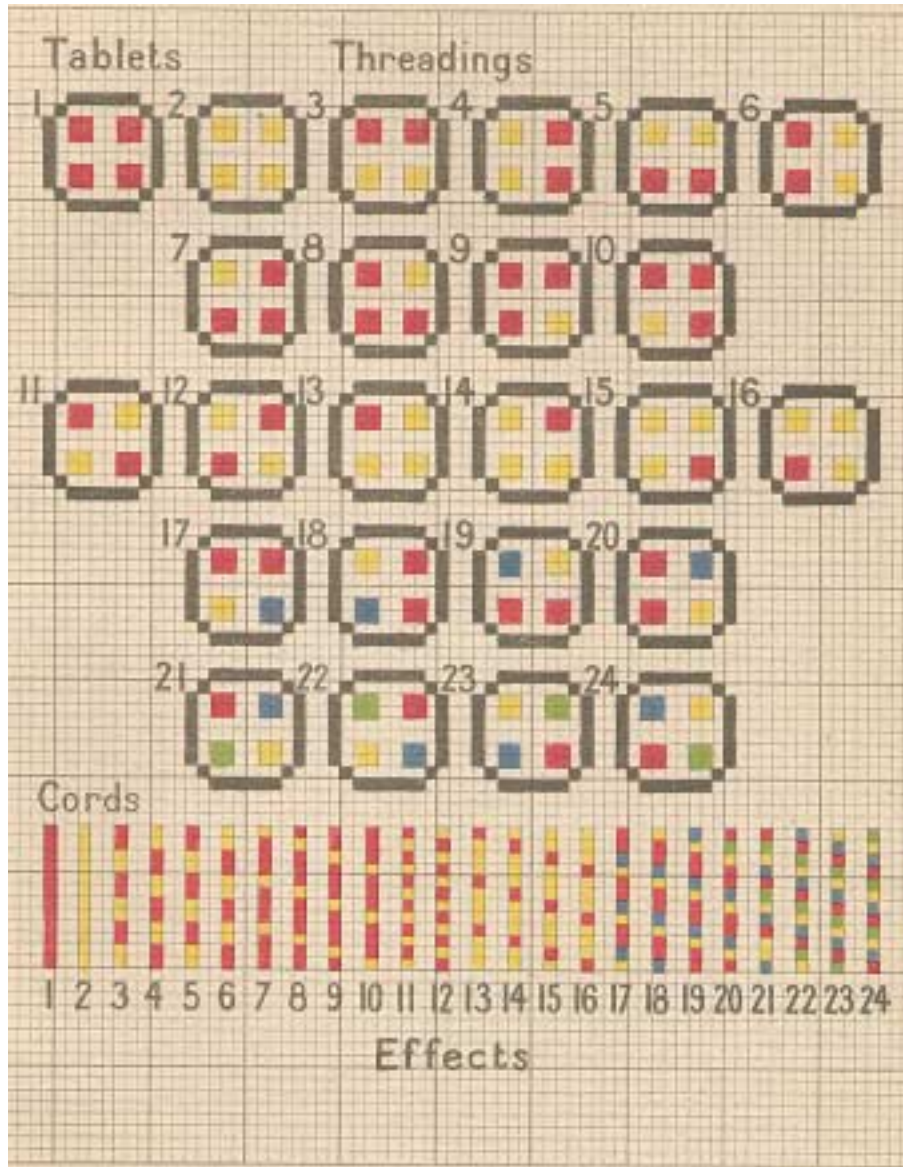

Fig. 43, page 51, is on thirteen tablets and must be arranged thus—

SPECIFICATION FOR FIG. 43, TO BE WOVEN IN TWO COLOURS

Tablet	Threading	Direction	Colours
I	I	Right	Black
2	2	"	White
3	3	"	Black and White
4	3	"	" "
5	I	Left	Black
6	II	Right	Black and White
7	12	Left	White and Black
8	II	Right	Black and White
9	I	"	Black
10	5	Left	White and Black
11	5	"	" "
12	2	"	White
13	I	"	Black

CHAPTER XIII

DIAGONALS AND CHEVRONS

IN Plates III, VI, and VII diagonal lines are introduced into the designs in addition to vertical lines, bands, and checkers. These new features do not result from new *threadings*, but from the order in which the similarly threaded tablets are placed in relation to one another, before starting to weave. *If the tablets are rightly placed at the beginning, the pattern, however complicated, will work out automatically* as the weaving proceeds, no matter which line of the design it starts on.

Of course, in order to match the threading and arrange the tablets correctly, great accuracy is required, and a careful study of the key (Plate V) and the diagram of the twisted cords at its foot is essential. This is particularly the case when several different colours are used, and the more complicated forms are attempted.

The use of diagonal lines, which have the effect of *twills* in ordinary weaving, and triangular forms in addition to squares, checkers, vertical lines, and bands immensely extend the scope and interest of designing for this fascinating branch of weaving, as will be seen from the few examples given on Plate VI and reproduced from woven examples on Plate VII.

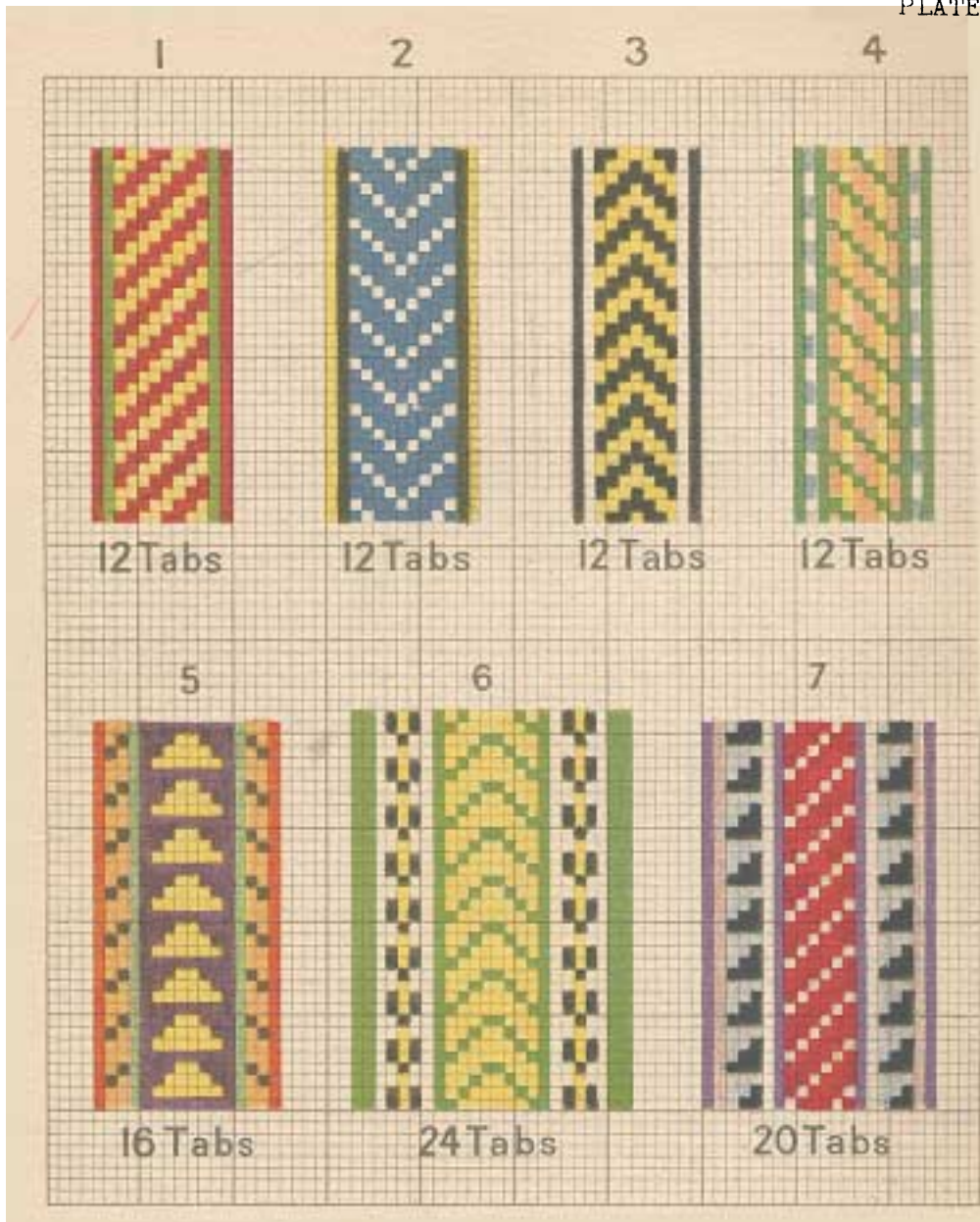

If the student has followed and thoroughly mastered all the instructions given up to this point, there should be no difficulty in working out and weaving from the following specifications any of the designs on Plate VI.

In the designs Nos. 2, 3, and 6, Plate VI, as well as on several designs on Plates III and VII, chevrons are introduced. For these it is not necessary to have an odd number of tablets, as indicated on No. 2, Plate VI. Figs. 5 and 6 on the same plate are correctly drawn. The blunt point of the figure disappears when woven with the tablets *facing one another* as shown in the specification, No. 5, page 61.

In chevron designs the point of the chevron can be turned up or down at will, as in Nos. 2 and 3, Plate III, by a method of reversing, which will be described in the next chapter.

NO. I—PLATE VI

Tablets	Threading	Direction	Colours
1	1	Left	Red
2	2	"	Green
3	3	"	Red and Yellow
4	4	"	" "
5	5	"	" "
6	6	"	" "
7	3	"	" "
8	4	"	" "
9	5	"	" "
10	6	"	" "
11	2	"	Green
12	1	"	Red

No. 2—PLATE VI

Tablets	Threading	Direction	Colours.
I	I	Left	Yellow
2	2	"	Black
3	7	"	White and Blue
4	8	"	" "
5	9	"	" "
6	10	"	" "
7	10	Right	" "
8	9	"	" "
9	8	"	" "
10	7	"	" "
11	2	"	Black
12	I	"	Yellow

No. 3—PLATE VI

Tablets	Threading	Direction	Colours
I	I	Right	Black
2	2	"	White
3	3	"	Black and Yellow
4	4	"	" "
5	5	"	" "
6	6	"	" "
7	6	Left	" "
8	5	"	" "
9	4	"	" "
10	3	"	" "
11	2	"	White
12	I	"	Black

No. 4—PLATE VI

Tablets	Threading	Direction	Colours
I	I	Right or Left	Green
2	5	" "	White and Blue
3	I	" "	Green
4	I3	" "	Green and Orange
5	I4	" "	Green and Yellow
6	I5	" "	Green and Orange
7	I6	" "	" "
8	I3	" "	Green and Yellow
9	I4	" "	Green and Orange
10	I	" "	Green
11	3	" "	Blue and White
12	I	" "	Green

No. 5—PLATE VI

Tablets	Threading	Direction	Colours
I	I	Left	Red
2	I3	"	Black and Orange
3	I4	"	" "
4	2	"	Green
5	I	"	Purple
6	10	"	Purple and Yellow
7	5	"	" "
8	I3	"	" "
9	I3	Right	" "
10	5	"	" "
11	10	"	" "
12	I	"	Purple
13	2	"	Green
14	I4	"	Black and Orange
15	I3	"	" "
16	I	"	Red

No. 6—PLATE VI

Tablets	Threading	Direction	Colours
I	I	Left	Green
2	2	Right	Silver
3	6	"	Black and Silver
4	I4	"	Black and Yellow
5	I4	Left	" "
6	6	"	Black and Silver
7	2	"	Silver
8	I	"	Green
9	I6	"	Yellow and Green
10	I5	"	" "
11	I4	"	" "
12	I3	"	" "
13	I3	Right	" "
14	I4	"	" "
15	I5	Right	Yellow and Green
16	I6	"	" "
17	I	"	Green
18	2	"	Silver
19	6	"	Black and Silver
20	I4	"	Black and Yellow
21	I4	Left	" "
22	6	"	Black and Silver
23	2	"	Silver
24	I	Right	Green

In weaving the above for Plate VII, No. 4, it was necessary, in order to work the small check inverted chevrons of the borders, to begin with only one cord of green so as to allow two cords for the point, as before explained.

No. 7—PLATE VI

Tablets	Threading	Direction	Colours
1	1	Left	Purple
2	2	"	White
3	13	"	Blue and Black
4	3	"	" "
5	10	"	" "
6	2	"	White
7	1	"	Purple
8	8	"	Red and White
9	9	"	" "
10	10	"	" "
11	7	"	" "
12	8	"	" "
13	9	"	" "
14	1	"	Purple
15	2	"	White
16	13	"	Blue and Black
17	3	"	" "
18	10	"	" "
19	2	"	White
20	1	"	Purple

CHAPTER XIV

REVERSING

THE woven braids on Plates III (Nos. 2 and 3) and VII (Nos. 1, 3, and 5) are examples of the effect of *reversing*, as it is called, which is simply ceasing to turn the tablets *one way*, backward or forward, and turning them in the *opposite direction*. In all these examples, except No. 5, Plate VII, the places where this reversing takes place is marked with a cross. It will at once be seen what a great addition to the scope for designing this facility for giving variety to the repeats of a pattern affords.

It is not necessary for all the tablets to be reversed, although it is rather easier to turn them all than to turn a portion of them. It is generally best to keep the edge cords of a braid turning one way throughout, because at the point of reverse a little dent is apt to be made which spoils the continuity of the edge.

Plate VII, No. 5, at O O, gives an example of reversing at every two quarter turns. This is the only method of making any one feature of the braid in tablet weaving of greater height than four quarter turns of the tablets will weave. It is sometimes effective, but should not be used to a great extent because the character of texture it gives is not quite the same as that which the ordinary straightforward turning gives: the twisted effect of cord

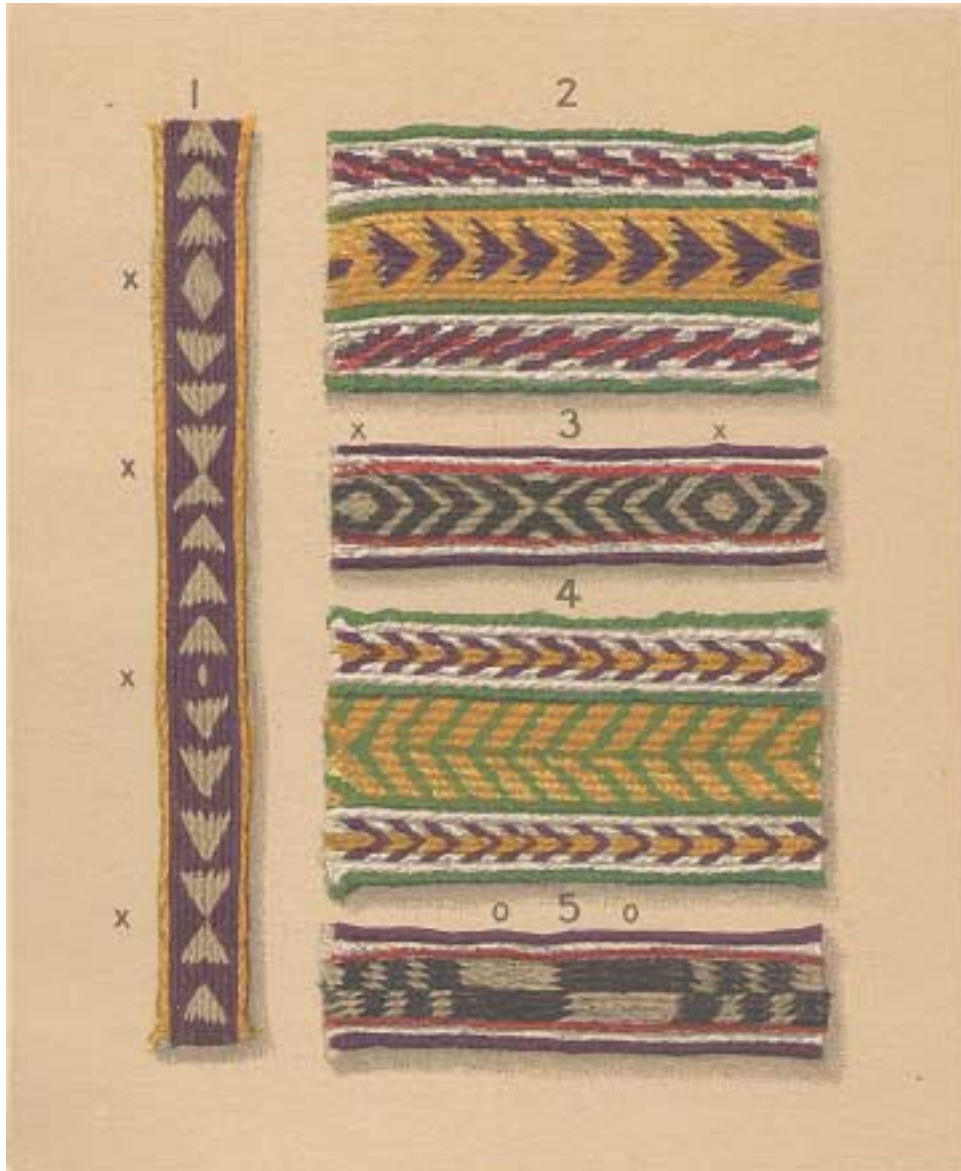

almost disappears and the texture is more like that of ordinary weaving.

With this description of the method of reversing the present course of instruction in tablet weaving must terminate. It is true that much more elaborate designs may be woven if more tablets are used, or if they are divided into groups and turned in opposite directions, or if tablets pierced with six holes instead of four are made use of. Ordinary double weaving can also be done by special arrangements.

All these developments, however, require a very great deal of study to understand and much practice to manipulate. This advanced tablet weaving would, of course, be very interesting to the ingenious student, but would scarcely repay him for the labour necessary to master it, as similar effects can be produced more readily by other methods of weaving. There can be no doubt that it is in the production of such simple, useful, and delightful braids as those which have occupied our attention hitherto, that the special province of the tablets, in the general art of weaving, is to be found. It is true in weaving as in all the arts that the best results are always produced by the simplest means.

INDEX

- ARRANGING the tablets in loom, 41
 ——— in pairs, effect of, 49
- BOBBIN stand, description of, 17
- Braid, the simplest braid for tablet weaving, 16
 ———, texture of a tablet, 39
- Braids, specifications for different patterns, 55, 56, 57, 59, 60, 61, 62, 63
- CARTON weaving, *see* Tablet weaving, 1
- Checker designs, 47
- Chevron designs, 58
- Coloured yarns, necessity for good, 32
- Cross in the warp, securing it, 19
- DICE pattern designs, *see* Checkers, 47
- FIRST practice in tablet weaving, 37
- KEY diagram, Plate V, explanation of, 54
- PLACING the tablets correctly before beginning to weave, necessity of, 53, 58
- REVERSING designs, 64
- SHUTTLE for tablet weaving, the, 38
- Specifications for various patterned braids, 55, 56, 57, 59, 60, 61, 62, 63
- TABLET, description of a, 6
 ——— loom, description of, 8
 ——— ———, how to mount the tablets in a, 24
 ——— ———, its parts described, 9
- Tablets, threading the, 24, 33, 34, 45
 ——— weaving, automatic, 3
 ——— ———, a very ancient art of Eastern origin, 1
 ——— ———, a warp effect, 41
 ——— ——— on tapestry in Rheims Cathedral, 2
- Turning the bundle of tablets for weaving, 35
 ——— ——— tablets, 41
- Twill or diagonal designs, 58
- WARP, fixing the, in the loom, 21
 ———, the cross in the, 12, 14, 17, 19
 ———, ———, how to prepare it, 12
 ———, ———, taking it off the board, 19
 ———, ———, winding it on to a reel, 21
- Warping board, the, 12
 ———, description of, 13, 14, 15, 16
 ——— for braids of coloured vertical stripes, 44, 45, 46
 ———, importance of, 12
- Weaving a foundation to work on, 36
- Weft, method of interlacing the warp with the, 38
- Weights for keeping the warp at an even tension, 30
- YARNS suitable for tablet weaving, 31

Established 1898

The

Telephone: Mayfair 6595

London School of Weaving

13 Old Cavendish St., Cavendish Square, W.1

(5 minutes from Oxford Circus)

• • •

Best training for prospective teachers
and craftswomen. Certificate given
when proficient

Suppliers to Government and the Colonies
with the latest in Spinning Wheels,
Looms, and all Weaving Appliances

• • •

For Prospectus and Price List apply to the Principal at above address

EMBROIDERY & TAPESTRY WEAVING

By MRS. A. H. CHRISTIE.

Fourth Edition.

The *Pall Mall Gazette* says: "Mrs. Christie has performed her task to admiration, . . . and her lucid explanations of various kinds of stitches . . . should be of value to all workers at embroidery or tapestry weaving and to novices anxious to learn."

178 Diagrams and Illustrations by the Author; 16 pp. of Collotype Reproductions. Small crown 8vo, 320 pp. 10s. 6d. net.

DRESS DESIGN

AN ACCOUNT OF COSTUME FOR ARTISTS AND DRESSMAKERS

By TALBOT HUGHES.

A handbook on historic costume from early times, containing over 600 figures, 35 half-tone reproductions of 100 specimens of genuine dresses, besides 80 scaled patterns taken from antique apparel, together with over 400 illustrations of head-dresses and foot-wear (correctly dated). In small crown 8vo, 362 pp. 12s. 6d. net.

OF BOOKSELLERS. OR DIRECT FROM

SIR ISAAC PITMAN & SONS, LTD., PARKER STREET, KINGSWAY, LONDON, W.C.2

Ford, Ayrton & Co., Ltd.

Silk Spinners

Manufacturers of all classes of—

Spun Silk Yarns for Hand and Power Weaving.

Warp—Hank—Cop—Cheese—Cone.

Knitting Silks (Hand and Machine) for
Jumpers, Underwear, Hose, Etc.

Embroideries, Sewings.

Natural Colour or Dyed.

Dressed Silk for Hand Spinning.

Low Bentham - Yorkshire - England

WALDO S. LANCHESTER

Maker of

HOOPER

and all



LOOMS,

accessories.

Orders for spinning and weaving
appliances carefully carried out.

34 NEW NORTH STREET, W.C.1