

setting-on handle, by means of which the attendant can bring the bobbin very gradually in contact with the driving drum, instead of its being allowed to tumble against it. The jerking start made with the last-named method very frequently breaks the threads again, especially when tender and fine yarns are being wound. By the improvement described these breakages are avoided. Another is the introduction of an adjustable weight, which is carried upon a lever attached to and projecting backwards from the bobbin cradle. This is a novel application, so far as this type of machine is concerned, and by its means the pressure of the bobbin upon the drum can be made heavy or light as may be desired. An improvement has also been effected in the gearing through which the traverse motion is actuated, which renders the driving of the traverse very simple and noiseless. This consists of the introduction of a pair of helical wheels instead of the bevels ordinarily employed for transmitting power from the drum shaft to the short horizontal shaft carrying the heart cams. The connection between the vertical and horizontal shaft is effected by a worm upon the bottom of the former, which gears into a worm wheel on the latter. This driving arrangement obviates the noise and back-lash incident to the ordinary method. The traverse lever is made adjustable in length so as to easily yield any length of traverse as required. An improved strap fork and starting arrangement has also been introduced. This consists of a handle carrying a small pinion which is attached to the base of the fork. The latter is mounted upon a stud in such a manner as to slide backward and forward. The under part of this stud forms a rack into which the pinion gears, and thus by means of the handle the fork is traversed with ease from one pulley to the other as required. Its great merit is its adaptability to any width of pulley, and the facility with which it can be made to govern the length of the traverse of the strap. The rice creel is made of iron, and the rices are mounted

upon a round shaft extending the length of the frame instead of being dependent from the upper parallel rail as before. This ensures easier adjustment whenever such may be needed. The adjustable barrel creel, shown on the opposite side, is also made in an improved manner. The top barrel is fixed, the bottom barrel being carried on a centre, and is adjustable for various sizes of hanks.

The principles, purposes, and the earlier forms of warping have been sufficiently explained, the first need only here be summarized as the laying in parallel order of the yarns intended to form the length of the woven fabric when intersected with its weft or cross threads.

The invention of the dressing and sizing machines, the latter especially, necessitated a radical change in the system of warping for the manufacture of ordinary plain goods. This came in the invention of the beaming machine, which appears to have been the product of the inventive skill of Thomas Johnson, of Stockport, who endowed the trade with the dressing machine. The beaming machine was a necessity of the dressing machine, and its invention was, therefore, an adjunct of it. It is described in his patent for the dressing machine granted February 28th, 1803. Little improvement appears to have been made in it until the invention of the now well-known "warping-frame," as it was called, which in Patent 9660, March 11th, 1843, is credited to William Kenworthy, then manager of Brookhouse Mills, Blackburn. The latter machine was a great commercial success. It consisted of a creel holding about 400 bobbins, a frame containing a coarse open reed, and beyond these, in the direction of the beam, a series of iron rods so mounted in the frame that they could be made to fall and reverse the revolution of the beam, delivering back the warp to the extent of several yards when a thread had broken, in order to permit of its being taken up and pieced. This facility gave this invention its great superiority over anything previously in use. The machine contained a large

wooden cylinder mounted upon the driving shaft, and on this the warper's beam rested, being driven by the friction surface contact. Thus whatever might be its diameter a uniform speed was maintained, derived from the driving cylinder.

This invention sustained its pre-eminence during its existence as a patent, and for ten or fifteen years subsequently. Afterwards it became the subject of further improvement in details, and a number of these were introduced which may be passed with merely the mention of the expanding reed, or comb, introduced to facilitate the distribution of a small number of ends over the barrel of a wide beam in order to avoid the necessity of moving its flanges nearer together. Another was to mount the "falling rods" upon their centres, so as to diminish their friction and ease the passage of the yarn over them on its way to the beam.

Not much of real improvement, however, was effected until the invention of the automatic stopping motion, which stopped the machine immediately on the breakage of a thread. There are two claimants for this invention, William Rosseter and Thomas Singleton. The first-named appears from the records of the Patent Office to have been the first in the field with this idea, which the latter improved upon, and finally got the chief credit and reward of success, owing to the superiority of his invention. The machine known by his name is now in almost universal use where beaming machines are required. Its most modern form is illustrated in figs. 160, 161. Only a brief description is necessary.

The machine, as will be seen from the illustration, fig. 160, consists of two principal parts, the creel and the headstock. The creel is the frame which contains the bobbins as they come from the winding machine. It has two sides, which are arranged or placed together in the form of the letter V, with its apex towards the headstock of the machine. In the back of the headstock, near the apex, stands a coarse open reed, A, fig. 161, through which

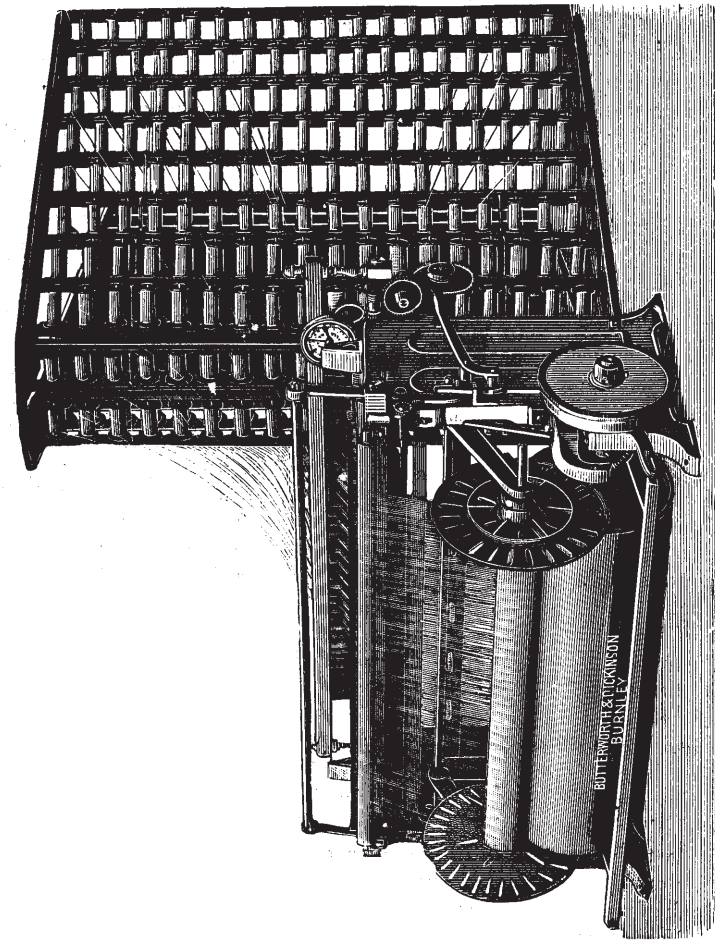

FIG. 160.

the yarn from the bobbins is brought. Passing over the carrier roller, B, it descends under the first drop or reversing roller, C, over another carrier, D, and under the second drop roller, E. Two drop rollers are all that are required since the invention of Singleton's automatic stop motion. Formerly there were six, or any other number deemed sufficient to meet requirements. Leaving the second drop roller the yarn passes over another roller, F, which besides being a carrier, has the more important function of measuring the length of yarn that passes, and hence is termed the measuring roller. All these rollers are tin cylinders. From the latter the yarn goes forward over a plate or bar, G, containing three slots of about one-eighth inch wide, which extend across the width of the machine. Each thread has a small bent wire, about $1\frac{1}{2}$ inch in length, hung upon it at this position, the ends of which descend into the slots in the bar beneath, and by them are retained in position. Leaving here the yarn next passes through an expanding comb, H, and thence over the carrier roller, J, to the beam, K. The comb, H, is so constructed that it will expand or contract by the turning of the screw, H, of which there are two, one at each end. These are furnished with a hand wheel, as shewn. The purpose of this expansion is to evenly spread the yarn over the beam between the flanges to prevent its forming ridges and hollows which strain the yarn, or cause it to run slack in being drawn off in the sizing process, and both of which would produce undesirable results.

The mechanism may now be briefly described. Extending across the front of the machine is the footboard, L. This, when starting the machine, is pressed down by the foot of the attendant, and at a certain position is held by a spring handle entering a detent upon the frame. The driving shaft, M, has fixed upon it a friction plate, N. Next thereto is the pulley, P, which is loose upon the shaft. Beyond this is the loose inclined collar, R, which

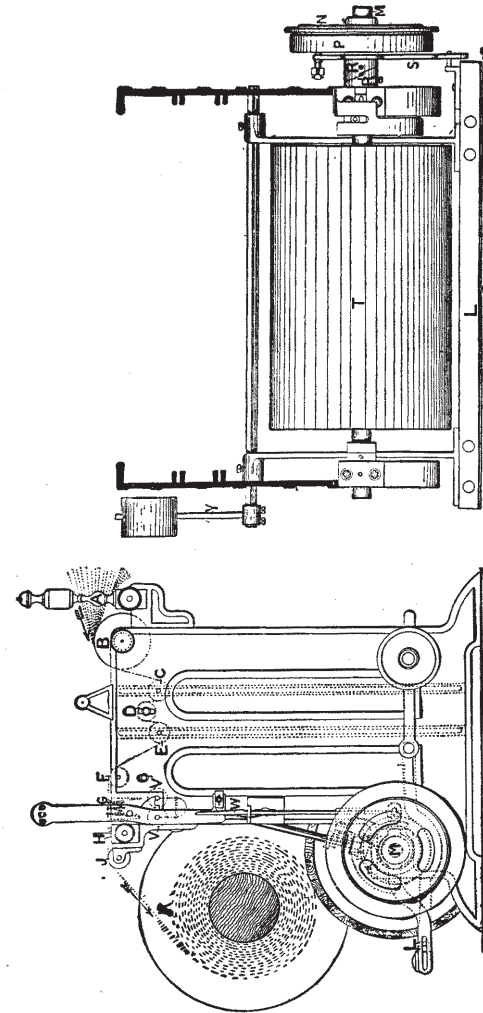

FIG. 161.—BEAMING MACHINE; SIDE ELEVATION; PLAN.

is set against the corresponding incline, *r'*, made fast upon the shaft. The inclined collar, *r*, and the footboard, *L*, are connected by the lever, *s*, which is fast upon the loose collar, *r*. When the two inclined collars are in the position shown in the figure, the pulley, *p*, runs loose upon the shaft and the machine is stopped. When the machine is started the loose inclined collar makes a partial turn, so as to close up the hole shown near the letter *r*, and in doing so it also slides laterally upon the shaft pressing the pulley, *p*, against the friction plate, *n*, which being fixed, becomes the driver and starts the machine. The wood cylinder, *t*, being fast upon the driving shaft with the beam, *k*, resting upon it, drives the latter by frictional contact.

We now come to the automatic stopping arrangement. The drop wires or pins hanging upon the threads on the breakage of any of them, or the exhaustion of a bobbin, the wire belonging to it instantly falls between the two rollers, *v v'*. These are termed the nip rollers, one of which is mounted in loose bearings. When a pin falls it is drawn between the rollers, and consequently presses the loose one, *v'*, away from its fellow. The lateral movement of the loose roller pushes the spring handle out of its detent, reverses the movement of the inclined collar, *r*, relieves the pressure upon the pulley, *p*, which then runs loose, and stops the machine. The weighted lever, *y*, is simply a balance for the footboard or treadle, *L*. In the rare event of the machine not being responsive to, or the stopping arrangement being slightly delayed in its action, which can only occur when the pin slots have an accumulation of waste down upon them which impedes the drop of the wire, the end of the broken thread is drawn upon the beam. To recover it the machine is stopped, and the winding reversed by means of the drop rods, until the end of the broken thread is recovered.

The beaming machine is fitted with a very accurate measuring motion, to insure a correct register of the

length run upon the beam. It is necessary the length should be correctly known and controlled in order that sets of beams may be made of any required uniform length, and when combined and worked off in the sizing machine, that they should finish all together. Were it otherwise the yarn left upon any or all the beams after the first had run off would be wasted. It is also desirable to prevent waste occurring in this manner, that the yarn shall be worked in all the beaming machines at a uniform tension, and that as light as possible. In fact, in all the processes of manufacture preceding the weaving, it should be regarded as a cardinal principle that the yarn should never be stretched, or in any way have its elastic strength drawn upon, as this is strained to the utmost in weaving.

The attendants upon these machines are females, who are generally termed warpers. It should be observed, however, that the beams made upon it are not warps, but merely longitudinal sections of warps, as it requires generally from four to six of these beams combining and their contents being run off together, to form a warp. The beams usually contain from 400 to 500 threads, and as many of them are combined in the creel of the sizing machine as will give the requisite number to form the fabric required.

The length of the yarn run upon these beams is generally stated in "wraps," this being the name given to one complete circuit of the measuring mechanism upon the machine. This consists of the measuring roller, *r*, the circumference of which is 18 inches. Upon the axis of this roller is a worm gearing with a wheel containing 54 teeth; on the stud of this wheel there is fixed a second worm wheel, containing 132 teeth. The first worm takes a tooth at each revolution of the measuring roller, which represents half a yard; a complete revolution of the first wheel into which it gears represents the passage of 27 yards. One revolution of this wheel represents the

movement of a tooth only on the second wheel, and as the latter contains 132 teeth, and one revolution of this is required to form a wrap, it follows that a wrap upon this gearing contains 3,564 yds. A beam generally contains four or five wraps, equal to 14,256 yards, or 17,820 yards respectively. The length of the wrap varies according to the details of the gearing, of which there are several. Assuming that the beam contains 500 ends, and that five of this kind are combined and run off together, they will form a warp or weaver's beam, containing 2,500 threads, which set in a 60 reed taking 60 threads per inch, would fill a width of 41.66 inches. Allowing for contraction this would make a cloth full 39 inches wide of 16 threads per $\frac{1}{4}$ inch. Taking the greater length of 17,820 yards, and dividing it by 40, the length of warp usually allowed to make a $37\frac{1}{2}$ yards Indian shirting, contraction thus being allowed for, the set of beams from the beaming machine would thus give 445.50 pieces. These would make 20 or 21 warps for the weaver's loom of 22 or 21 pieces each, which is the number usually put upon a loom beam.

In the coloured goods trade another method of warping is needed, owing to the large assortment of patterns required by dealers in these classes of goods and the small number of pieces of each. A set of warp beams such as are used in the plain cloth trade just described would be quite beyond the requirements of the market. The warping must therefore necessarily be done in small quantities of the selected patterns, the result being that special machines designed for the purpose must be called into requisition. The old-fashioned warping or reel mill already described was in use in this branch until within about twenty years ago, when it was superseded by an improved machine termed the section warping mill, which gave the manufacturer great facilities compared with those of the old reel machine. In fact, work can be done with ease and cheapness in the way of varying patterns, that

on the old plans would have been almost prohibitive on account of cost. On this machine the patterns, whatever may be their variety, are made by the use of a creel containing about 250 bobbins or other numbers required to form a complete pattern or part of a pattern, and then making as many small warps, called sections, as are needed to complete the width of the cloth to be made and the

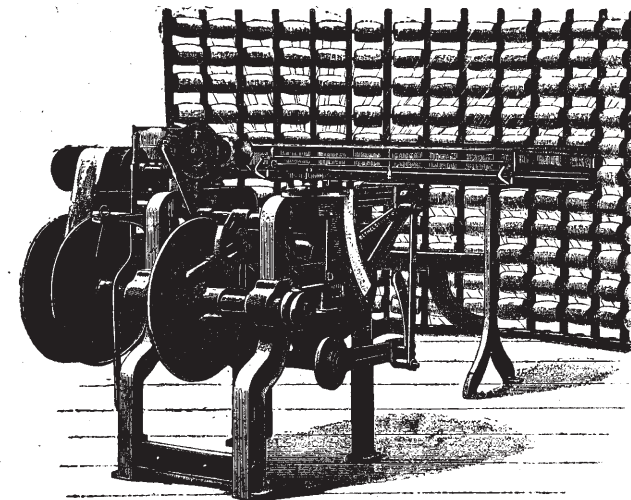

FIG. 162.—SECTION WARPING MILL.

number of patterns it will contain. When this number of sections has been made, they are put together on a common spindle and wound therefrom upon the loom beam.

The machine is illustrated in fig. 162, and consists of parts almost identical with or equivalent to those of the beaming machine already described for plain goods. The creel, which is here represented as semicircular, may also be of the V form. It is usually made to contain about

250 bobbins. From these yarn passes through the wide reed shown. In some cases the automatic stop-motion on the Singleton principle is introduced at this point, but this having already been described it has not been deemed necessary to introduce it again. The yarn next passes to a condensing or contracting reed, partly seen behind the roller over which the yarn is shown as passing. This reed is constructed in two pieces, which are hinged together in the middle, and so made to open and close somewhat like the covers of a book when set on end. It is opened or closed to such an extent as to bring the yarn into the compass of and evenly distribute it over the diminutive beam termed the section-block, upon which it has to be wound. The remainder of the headstock consists of the necessary mechanism for winding, compressing, measuring, marking, and doffing the section warp when completed.

In working this machine the warper brings the yarn from the creel through the parts of the machine already described, runs the headstock a few revolutions without yarn, adjusts a section block between the two outer flanges, fastens the yarn in a hole made in the block for the purpose, turns the machine half a revolution, then puts in the lease cords and turns the machine another half a revolution. This brings the lease cords over the top of the measuring roller, the starting-point from which the measurement of the piece lengths must be made. There is a special piece of mechanism for this purpose termed the measuring motion. It is adjusted and connected on starting a section for marking by drawing out of gear the small double wheel, E, which connects with the wheel, F, and the worm below it; then turning the wheel, F, which is a dial wheel numbered in sections of 5 up to 100, though the figures are not given in the illustration, to the left, until the movement brings the number corresponding to the length of yards required opposite a pointer fixed below, and the highest number on

the star wheel behind, F, to the same position. Then the double wheel, E, is replaced into gear as before. The link-rod, A, is next taken off, and the toothed sector wheel, an arm of which bears the patentee's name, and the sector is wound down as far as possible by means of the handle, C, the two catches impelling the ratchet-wheel, D, being set back whilst this is done, when they are replaced. The first section warp, which usually contains one of the selvages, may now be proceeded with. A short length to form the "thrums" is first wound, which brings the number 100 on the wheel, F, exactly opposite the pointer. This movement rings the pointer bell. The cut or piece mark is then put on the yarn. The double wheel, E, is again drawn out of gear, the wheel, F, turned round in the direction in which it runs until the number corresponding with the length of the piece is again brought opposite the pointer, when the wheel, E, is replaced, and the winding of the section proceeds until it has been about half completed, when the pointer on the radial piece, G, behind the connecting link, A, must be fixed opposite to the line on the lever, H. The rod, A, must then be replaced, which is done by moving the two studs which carry it in their respective slots until the link can be put on easily without changing the position of the line on the bottom lever carrying the stud, relatively to the pointer on the radial piece, G. The work is then proceeded with until the section is finished.

The measuring motion is only required for the piece-marked section of the warp, and is afterwards thrown out of gear. In winding the subsequent sections care must be taken that the same number of revolutions are wound upon them as upon the marked section. These are given on the dial and star wheels.

The sections are easily doffed and the mechanism quickly rearranged for succeeding ones.

When a sufficient number of sections have been made for forming a warp, they are placed together on a spindle

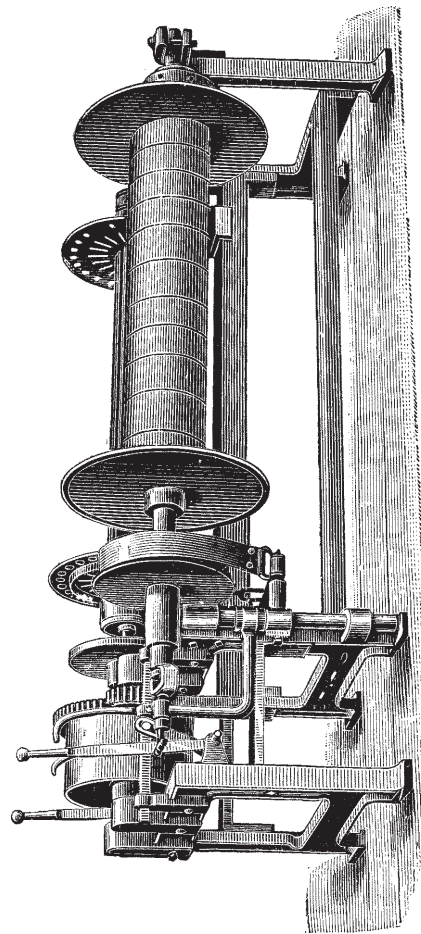

FIG. 163.—SECTION WARP BEAMING MACHINE.

and wound off upon a loom beam in a running-off machine, which is illustrated in fig. 163. This is a beaming machine, and is so simple that it will be comprehended without any further explanation by those who have perused the preceding pages.

It has previously been pointed out that the old system of ball warping, even when followed for making plain grey cloths only, was seriously defective. It was much more so when the warps, before passing to the loom, had to be bleached or dyed. In either of these cases the additional handling was very liable to magnify every fault. This was so much the case, that in dyed warps, especially in beaming, the warps had to undergo a dressing process, not the dressing process that will be shortly described as being an elementary stage of the sizing of to-day, but which consists of a careful examination of the warp as it is being beamed, piecing the broken threads, taking out knots, disentangling twisted portions, and otherwise clearing the warp from every obstacle to the weaver's operations. This was a very expensive treatment, and still remains so where no improvement has been adopted.

Appreciating the serious drawbacks of the old system of ball-warping, Mr. Garstang, a Lancashire manufacturer, a few years ago invented a new warping machine for making ball warps for bleaching or dyeing purposes specially designed for obviating the difficulties encountered in the ordinary process. This is illustrated in fig. 164. In it the inventor avails himself of the large beams made upon the beaming machine for the modern sizing machine. The new machine contains a creel, A, for the reception of a sufficient number of these beams to make a warp of the required width. The lease is obtained at starting in the ordinary way, and in combining them the warp runs off perfectly straight, and perfectly free from the twisting which takes place in the ordinary system. Instead of as in the slasher sizing system, the contents of each beam being superposed on each other in succession, each sheet

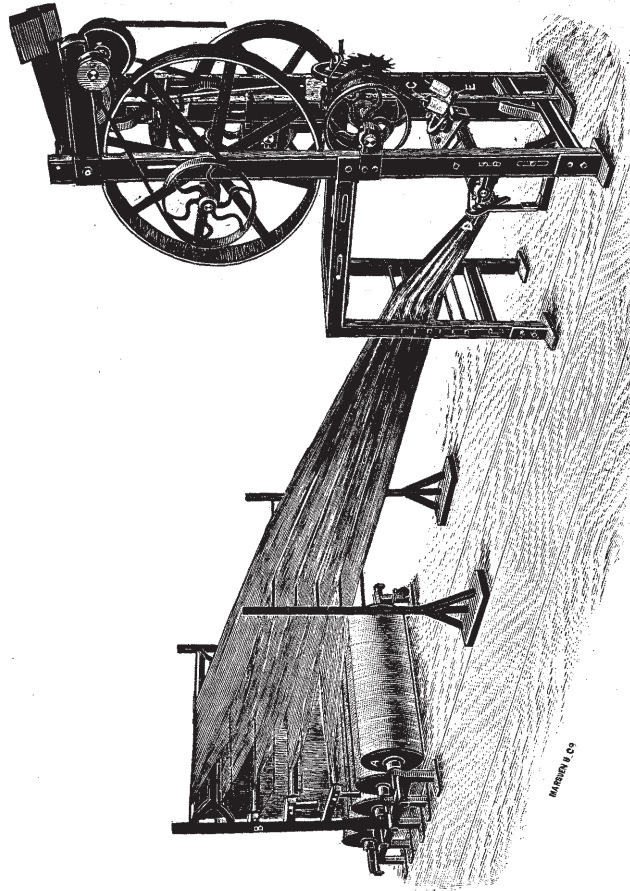

FIG. 164.—IMPROVED LOOSE WARPING MACHINE.

of threads is drawn from its respective beam over a set of three rollers, B, the middle one of which forms a tension drop roller, which automatically takes out the slack and thus aids to make the sections of perfectly uniform length. The beam creel is placed at a sufficient distance from the headstock to allow each sheet of threads to converge by the time they reach it into a narrow tape of threads, C, of about three inches width. Each of these sections is passed beneath a curved conductor, D, which lays them side by side, not upon each other. Thence the now united sections pass through a ring, just above which, and enclosing the warp, is a wheel, E, revolving upon carriers, and itself carrying a bracket upon which is placed two small bobbins of yarn. The revolution of this wheel with its bobbins wraps the warp with a binding thread which keeps it together, the turns being about one in every ten inches, or any other length as may be arranged. A turn in the above length has however been found sufficient for all purposes. The warp next passes over a measuring roller, where the piece lengths are automatically marked, thence around a pair of friction-pulleys and over a carrier roller into an open sack arranged for its reception. From beginning to end there is not a single turn put into the strand of threads forming the warp.

On the new machine a length equal to three loom warps, or say 3,000 yards, is run into one, forming one large warp. This is a great advantage in the matter of production, as it enables the machine to make long runs without stoppages, and thus greatly increases the quantity of work turned off. In dividing these warps into proper lengths the lease is "struck" with a comb, as in "slasher" sizing. At commencement and finish the leases are taken in sets of ten threads or any other number. The long warp is a great advantage to bleachers and dyers, as it almost obviates the tying together of the warps necessary for the passage in those of the ordinary length.

In point of production one of these machines will supply warps for 300 looms, weaving cloths of from 12 to 15 picks per quarter inch. One man and a boy can take charge of two machines, thus doing the work for 600 looms. The services of the boy are needed to tie up the piece-marks to prevent the obliteration of the mark in the dyeing process, as the tied-up portion does not absorb the dye. In the old ball-warping machine the warper had not only to mark the pieces by hand, but had to tie up the marks in the same manner, his mill being meanwhile stopped. In the new machine it continues at work. In the former case a large percentage of the working time is lost; in the latter it is all utilized, the boy tying up the marks as they come forward and dropping them into the sack.

It will be obvious from this description that the advantages of the new machine are very considerable in the increase of production, economy, freedom from the characteristic faults of the old system, and an absolute improvement of the work as compared with that obtained from the latter. In the old system throstle or ring-frame yarn was generally held to be indispensable, but owing to the better performance of the work in this machine mule-yarn, which is generally a little cheaper, can be substituted, and as good results obtained. Changes from plain cloth weaving to coloured work, and the reverse, can be made with facility, as up to the point of making warper's beams the processes are identical. A manufacturer can thus readily avail himself of the most profitable section of the market, as in plain cloth the only machines that would be stopped would be this warping machine and the subsequent dressing frame.

The inventor of the above machine has also displayed his skill in the invention of a new coloured warp-dressing machine, fig. 165. The frame in ordinary use is well known to those engaged in this branch of the trade, therefore little time need be spent in its description. In its

use the worker is only assisted to a limited extent by steam-power, and sometimes not at all. In the former it is only to the degree of winding the yarn upon the beam. The dresser, as the workman is called, does all the other work, which is very light, on the manual principle. The warp is placed beneath the frame, whence it is drawn through a set of tension rollers, thence over the "stangs" or winding-on poles. Between these poles and the beam is a distance of about twelve to fourteen feet, and in this space the workman conducts his operations. The warp having been separated into sections on the poles, the

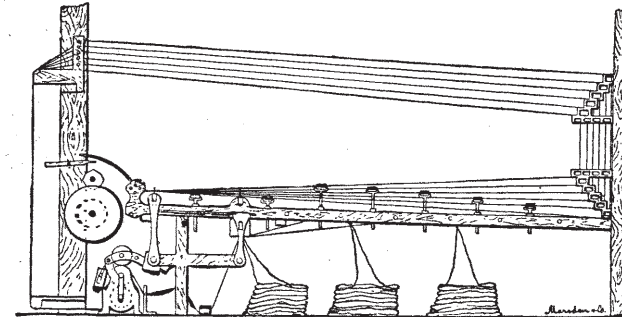

FIG. 165.—WARP DRESSING MACHINE.

dresser commences by brushing it backwards with a hand-brush, the length of which extends across the width of the warp. This brushing partially opens the warp, and removes the impurities acquired in the dyeing process. The warp is next further opened in a dressing-reed, and the threads are again more perfectly separated by the lease rods. After this it passes upon the beam.

Hand-dressing, as thus described, is a slow and expensive one, the workers earning from 36s. to 40s. per week for the performance of duties that certainly do not call for more skill than could easily be acquired by any youth or young woman from seventeen to twenty years of age,

and certainly not nearly as much as any average weaver possesses. The workmen, following practices very prevalent in the first thirty years of the century, have kept the occupation a close monopoly amongst the families and friends of those engaged in it; and so exclusive are they, that even yet in some instances they stipulate that they shall leave work several minutes in advance of the other workpeople and return several minutes later in order that they may not be compelled to mingle with the plebeians of the industry. This affords a remarkable illustration of the inconsistency which prevails amongst so many working people, even when they are asking for the abolition of all class distinction. Naturally enough where such pretensions are put forward, those who hold them may be expected to have made themselves troublesome in other directions.

It was experience of this kind which led to the invention of the new coloured warp dressing machine. In this the inventor introduces into the ordinary dressing frame two parallel bars or side rails, into which he places stands to carry the dressing brushes, which are thus, as it were, fixed, and over which the warp runs in its way to the beam. Before coming to the brush a "ravel" or "wraithe," a coarse comb, is introduced, which is suspended from cords. This substitutes the dressing reed of the older frame. The attendant moves it backward and forward to open the warp into "half beers." In this state it passes over the dressing brush. At this point we come to the principal improvement, which consists of the introduction of an expanding reed, of which the inventor also avails himself to form an automatic stop motion. This is accomplished by mounting the reed vertically upon two short standards pivoted in brackets, and kept in a vertical position by a number of spiral springs attached to a cross-rail in the frame, and to another upon the standards carrying the reed. When the warp, through entanglement or any other cause, sticks in the reed, the obstruc-

tion carries the latter forward towards the beam, and by means of a connecting rod attached to it, brings into action a catch, which through a wheel instantly stops the machine before any warp threads can be broken.

The simplicity and effectiveness of the new machine, and the perfect manner in which it has obviated the difficulties of the old one, is demonstrated in a very short time by an inspection of its working. Each of these machines will do twice the amount of work that can be obtained from the old one, whilst one man and a boy can easily superintend two, producing much better work than before. There is also a large economy in the wages paid for weaving, the work it produces ranking with "full dressed work."

There is still another warping machine which calls for a brief description. This is the chain warping, or chaining machine, as it is mostly called. The chain or linked warp is a form of warp best known in the districts where bleached and dyed fabrics are usually manufactured. Chaining is a process of linking up a long warp into such a form as to give it the appearance of a chain. This process shortens the warp very considerably, probably two-thirds, and greatly facilitates the handling in the processes of bleaching or dyeing, whilst it permits the free access of the bleaching liquor or colouring fluids to every portion of the warp. It is therefore a great convenience in these stages, and is extensively resorted to in Scotland, Yorkshire, and some districts of South Lancashire.

To chain a warp was formerly part of a warper's duty, and he who could perform it quickly and skilfully was highly valued. The lack or scarcity of these men led to the attempt to invent mechanical appliances to perform the work, but of these attempts very few came to anything approaching a successful issue. Success required that the movements of the human arm and hand should be most accurately imitated, and link up and interlock the warp in such a manner as would form a chain that

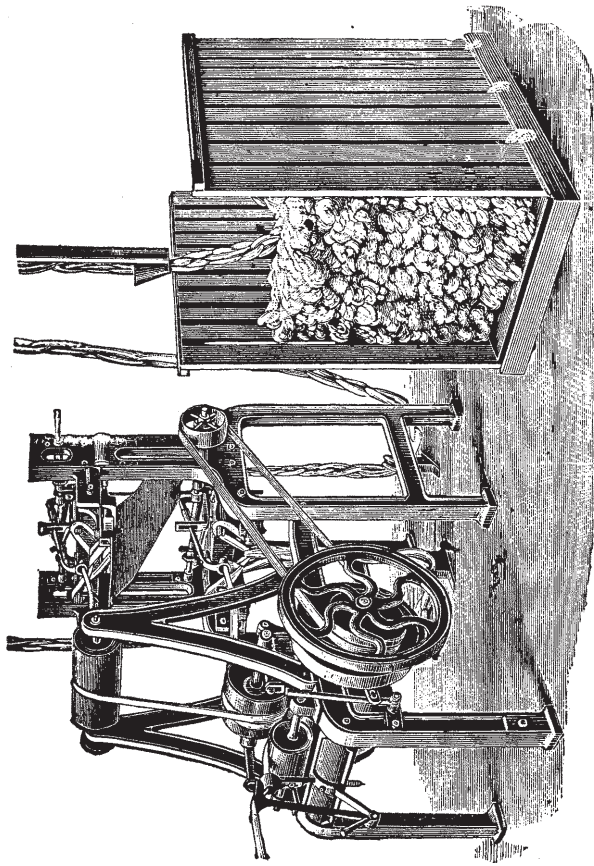

FIG. 166. — WARP CHAINING MACHINE.

should remain in that condition as long as needed, and afterwards be unlinked or drawn out with perfect ease and freedom without damaging any part in doing so.

The most, and indeed completely successful chaining machine yet invented, is that of the late Mr. William Hurst, of Rochdale, who exhibited and explained its working to the present writer a few years ago. Mr. Hurst was a cotton spinner, and in the course of business traded considerably in chained warps.

His invention, illustrated herewith (fig. 166), consists of a machine for making a double link chain or links of fine strands, by a series of reciprocating mechanical actions. The inventor fixes two projecting hooks or horns to the frame, and around these causes a trumpet-shaped guide to pass in such a manner as to carry the warp alternately around the horns. Within these horns grooves are constructed, in which are two other hooks which advance and recede. Beneath the fixed projecting horns, mounted upon the tops of two vertical shafts, are two revolving loopers, and as the trumpet-shaped guide passes around the fixed horns, the warp it is carrying is looped upon one of them. The sliding-hook in the latter then advances, and draws the warp inward along the horn. The sliding-hook is then liberated from the warp, in order to be in readiness for its next movement. Whilst these actions have been taking place, one of the revolving loopers has passed the previously formed loop over the second loop, and clear of the extremity of the fixed horn. This completes the operation, which then begins anew. This description shows the action of one side of the machine, and whilst it has been in operation the corresponding side, identical in construction and action, makes a corresponding series of movements in alternating order, and between the two the warp is chained in the most simple and perfect manner, and with the greatest expedition and ease.

The warp when chained is carried over pulleys, laid in

a box, and when complete tied up in a bundle and despatched for the next process. Alternately it may be allowed to fall upon the floor or into any suitable receptacle, or again, it may be passed over carrier rollers or pulleys to any convenient place.

The chaining machine makes its warp directly from the creel of bobbins; or it will chain a warp from a warping mill, or any machine by which warps are usually made. The link it makes is drawn out with the greatest ease, and the least friction upon the threads, whilst all through the processes of bleaching or dyeing the latter are kept well in their parallel order.

The original machine, as described above, has been modified, and the illustration represents it as constructed for making two chained warps at the same time. The alteration consists of the addition of a second linker, which is of great advantage when it is required to make chains containing only a small number of ends; as when two chains are made together, the liability of the ends to break when starting the beaming frame, is considerably reduced by the distribution of the strain over a greater number of threads. Also by making two chains at once the cost is reduced. When making only one chain the second linker is disconnected.

CHAPTER IX.

YARN BLEACHING AND DYEING.

Yarn bleaching and dyeing.—The processes of bleaching.—The injector kier, *illustrated*.—Chloring.—Souring.—Improved bleaching machine, *illustrated*.—Hank dyeing by hand in tubs and vats.—Mechanical systems of dyeing.—The Klauder-Weldon machine, *illustrated*.—Its advantages.—Hank drying; disadvantages of stoves.—Improved drying machine, *illustrated*; its advantages.—Hank stretching and brushing machine, *illustrated*.—Warp dyeing.—Cop dyeing; Graemiger's machine; Crippin's machine, *illustrated* and described.—Practical recipes for dyeing, and where to obtain them.

THE operations of yarn bleaching and dyeing are sometimes conducted upon the manufacturing premises, especially when, as is most frequently the case in foreign countries, the various industries have not become highly centralized and subdivided as in the English manufacturing districts. In the latter it is often regarded as preferable to send the yarn out to be bleached or dyed in establishments where it is done on an extensive scale and where, consequently, it can be performed with greater economy and often in a better manner. For the benefit of the former establishments and of students we may briefly describe the processes of bleaching and dyeing in their chemical and mechanical aspects. Yarns are usually submitted to these processes in the form of hanks or ball warps. Many efforts have, however, been made to bleach and dye them in the cop form, as by doing so the cost of two processes, reeling and re-winding, would be avoided. Recent efforts in this direction have been attended with a fair degree of success, as will be gathered from these pages a little further on.

The process of bleaching cotton yarns consists of several distinct operations, having for their object the discharge of

the vegetable wax, natural colouring matter, dirt, and grease in the raw material, the two former being always present and the two latter liable to be added in the passages through the stages of manufacture.

The actual process of bleaching varies, as might be expected, at different establishments, and also according to the requirements of the subsequent processes through which the bleached yarns have to pass. Thus, if they are intended to be dyed with common colours, or in dark shades of browns, greens, blues, or in black, the following operations will give a fair white such as will yield satisfactory results :

1st. Boiling in soda ash, or caustic soda, which forms soap by combination with the oily matters, making them soluble, and enabling them to be washed away.

2nd. Washing, with clear water.

3rd. Treating with a solution of bleaching powder (chloride of lime).

4th. Souring, otherwise acidifying.

5th. Washing, as before.

If a more perfect bleach be desired, such as would be suitable for fine colours, say alizarine pinks and roses, then the operations become more numerous and require more care. They are as follows :

1st. Boiling in alkali as before.

2nd. Washing.

3rd. Souring.

4th. Washing.

5th. A second alkali boil.

6th. Washing.

7th. Treating with bleaching powder.

8th. Washing.

9th. Souring.

10th. Washing.

Possibly in some cases it may be desirable to repeat the last four operations to get the best effects.

These various bleaching operations are performed in the following manner :

1st. The alkali boils are conducted in upright boilers or kiers as they are called, the tops of which are made loose so that they can be lifted off for filling or discharging. These tops require to be so constructed and arranged that they can be securely fastened and the kier be made steam-tight. One of these is illustrated in fig. 167. Through the centre of the kier there passes a steam pipe terminating in a spray diffuser. The alkali liquor is forced through this pipe by steam. The bottom of the kier is usually kept covered with a layer of stones. These kiers are used in the following manner :—They are first carefully charged with yarn laid in even layers ; the top is put on and made tight and secure ; by means of a steam injector the alkaline liquor is forced up the puffer pipe or central tube previously mentioned, from which it falls upon the yarn and draining through to the bottom is again blown up the pipe, and thus kept in circulation for three or four hours. The steam is then turned off, the liquor drained away, and clean water run in to wash the yarn before it is removed from the kier. The quantity of alkali required to be used in this operation varies ; if soda ash be employed, from two to three per cent. of the weight of the yarn ; if caustic soda be used, from one and a half to two per cent. After being taken out of the kier the yarn is wrung either by hand or a hank-wringing machine to press out of it all surplus liquor. Should it be necessary to wash it again, this is effected by hanging the yarn on sticks in a large rectangular tank, through which a current of water is kept flowing, the yarn being turned over from time to time. From this washing the yarns are wrung, when they are ready for the chloring or chemicking bath as it is called.

The chloring or treatment with a solution of bleaching powder is effected in either stone or wooden rectangular tanks, the former being to be preferred. The bleaching liquor is

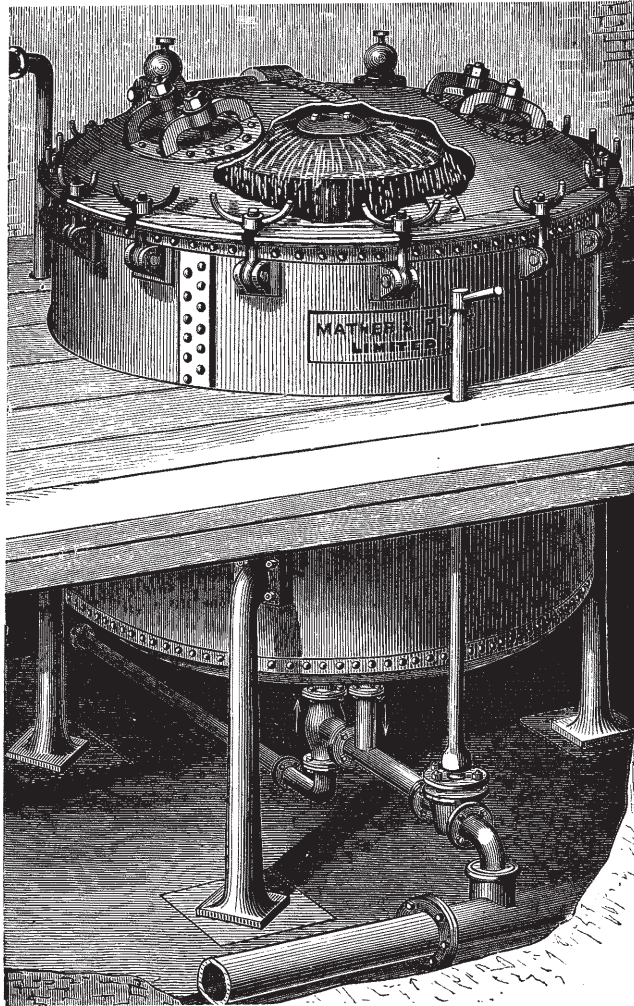

FIG. 167.—UPRIGHT YARN BLEACHING KIER.

used of a strength of 1 to $1\frac{1}{2}^{\circ}$ Twaddel. The hanks of yarn are hung in this liquor from wooden sticks laid upon the sides of the tank, or sometimes the yarn is immersed in the liquor. The former method, however, is preferable. The yarn is simply placed in it until it is completely saturated, which only takes a few minutes. The surplus liquor is then wrung out and the yarns laid in heaps on wooden stillages for some hours, care being taken that no part becomes dry. This may be secured by covering them over with wet cloths.

The souring, which is for the purpose of liberating the chlorine from the chloride of lime, is carried out in the same way as the bleaching or chemicking as it is sometimes called. For this a solution of hydrochloric acid of 1° Twaddel is used; or otherwise a solution of sulphuric acid of $\frac{1}{2}^{\circ}$ Twaddel. In this the yarn is immersed for about ten minutes, after which it is thoroughly washed. This final washing must be thoroughly well done, so that every trace of the chlorine or acid may be cleared away. The yarns may then be wrung out and dried for store if they are to be used in the white. If for dyeing, they only require wringing out, when they will be quite ready for the first operation.

In fig. 168 is shown a machine made by Messrs. Mather and Platt, of Manchester, in which all the operations of boiling, chemicking, and souring can be done without removing the hanks of yarn from the machine. This is a considerable advantage, as it saves labour in handling and tangling of the yarn. As will be seen, it consists of a wooden tank furnished with a false bottom, on which the yarn is placed. On the floor beside the tank are three cisterns for the reception of the liquors with which the yarn is to be treated. Centrifugal pumps, with the necessary pipes, connect the tank and the cisterns, and a steam injector is provided for spraying the goods with the alkali liquor. The yarn to be bleached is placed in the tank, and the pump, connected with the alkali cistern and the steam

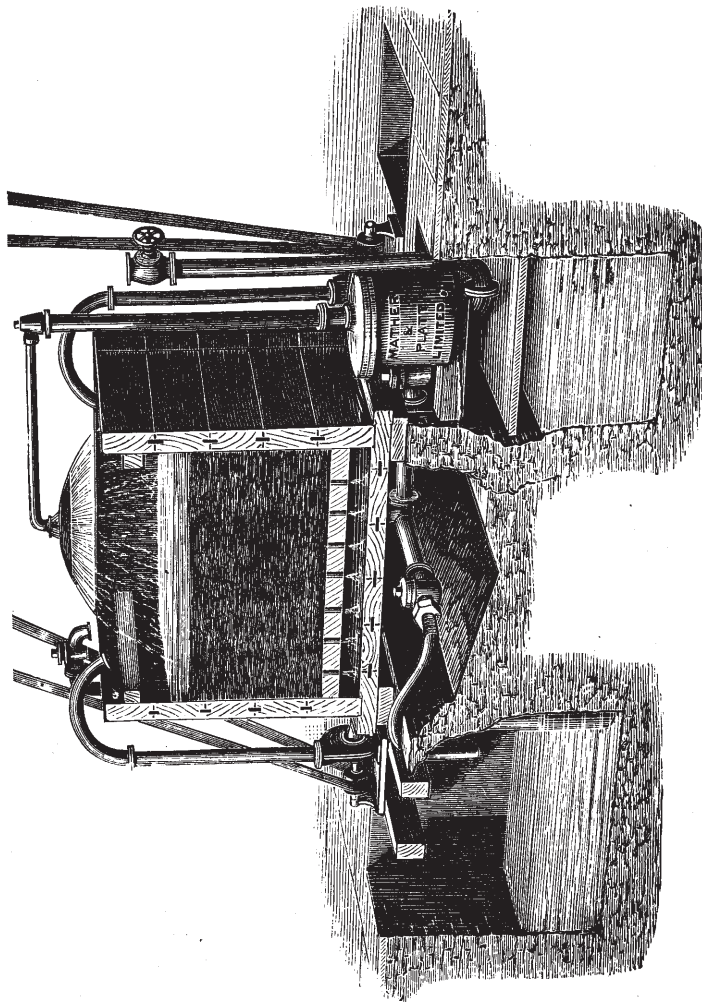

FIG. 168.--IMPROVED YARN BLEACHING KIER.

injector is set in motion. This draws the liquor from the cistern, which is conveyed through the tubes and sprayed over the yarn in the tank. The liquor drains through the yarn and runs back into the cistern whence it was first drawn. This circuitous movement is continued until the treatment is regarded as sufficient. Then the yarn is washed with water. The first pump is then stopped, and the second pump connected with the chemic cistern is set to work, and the liquor sprayed over the goods in like manner. When this has gone on a sufficient length of time it is discontinued, and the yarn is next treated with a weak acid liquor, sent over it from another pump from the acid cistern. The yarn is then well washed with clean water, and this completed, it is ready for drying. This machine is a very economical one, as it saves a good deal of handling.

A few remarks may here be appropriately introduced on the subject and process of dyeing cotton yarn. This is generally dyed in hank or warp state, the first named being the form in which it is mostly so treated. In either state it may be dyed by hand or machine. The mechanical method of treatment is, however, coming strongly to the front, as larger quantities can be treated, less labour is required, and a smaller quantity of dye-stuff is used, so that mechanical dyeing has been demonstrated to be the most economical method.

In hank dyeing by hand, when the yarn is in small lots, bath tubs are used of such a depth that they will receive the full length of the hank when hanging straight down from the stick from which it is suspended. These sticks, which are placed horizontally across the tubs, are usually made of hickory or ash, with as smooth a surface as can be got upon them. The sticks are supported by the edges of the tub.

When larger quantities of yarn are being treated, large rectangular vats or troughs are substituted for the tubs. These are of such a width that the sticks of yarn can be supported by the sides, the depth being sufficient, as

before, to receive the length of the hank. The dye liquor in the vat is heated by means of a steam pipe passing along the bottom.

The method of working is the same with both tub and vat. A bundle of yarn in hanks is placed upon a stick and carefully shaken in order to loosen it as much as possible, so that the dye liquor will perfectly and evenly penetrate it all alike. It is then dipped into the dye liquor which has been previously poured into the tub or vat. After one or two dips, the yarn is lifted and turned on the stick, so that the portion that was in the first instance upon the stick now hangs down to the bottom, the bottom portion having been brought to the top. The yarn is then again dipped, and allowed to hang in the liquor. Every bundle of yarn in the lot which is to be dyed passes through this operation. Next the first stickful is taken and the yarn turned over, re-dipped, and hung in the dye liquor. The second and the following sticks are dealt with in the same manner until all have made the passage once more. This is then repeated until the proper shade has been gained. It is next taken out, wrung free from surplus dye liquor, well washed and dried. It will be apparent from these observations that all the movements of the yarn in these cases are effected by hand.

In the mechanical system of dyeing nearly all are performed by the machine. Of these there are a number. One of the best and of the most recent introduction is the Klauder-Weldon machine, several illustrations of which are given herewith, from which the construction and mode of working will readily be gathered when aided by a brief description.

The illustrations given of the machine obviate the necessity of any lengthened description, as they will speak powerfully to the eye of the practical man in commendation of its simplicity and merits. As will be seen from fig. 169, the machine consists of a wood framework or casing, the bottom part of which forms the beck or trough to con-

tain the wash or dye liquor. Two discs properly mounted constitute a reel or skeleton cylinder, which is arranged horizontally in the frame, and is completed by the sticks carrying the yarn or slubbing which, when in position, form the periphery. The whole is covered in as shewn, and when at work the doors are closed. Fig. 170 shews the machine charged with hanks and ready for work.

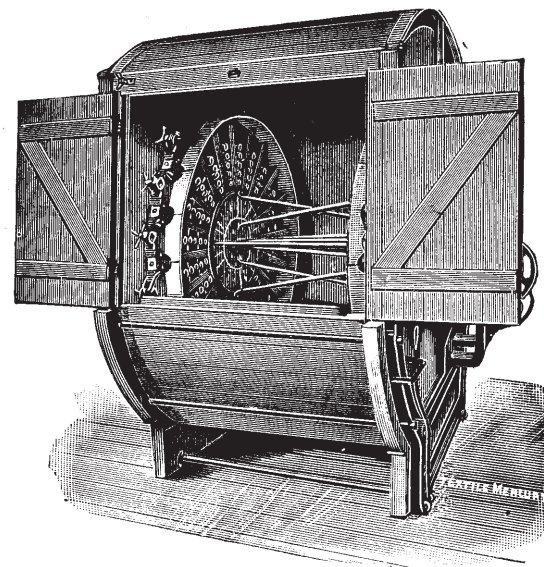

FIG. 169.—THE KLAUDER-WELDON DYEING MACHINE.

Fig. 171 shews the driving-gear, the cylinder axis projects to the outside of the casing, where it carries a worm-wheel, gearing into a worm. It is driven through suitable connections from the pulley as exhibited. If required it may be driven from a pair of step cones by which variations in speed may be had if desired. In this illus-

tration the cover is removed, the machine is shown charged with yarn, with the hanks sustained in position by one end being carried upon the stick as seen, and the second upon another stick which finds its position near the axis. In fig. 172 is given a view on the side opposite to the gearing with the pan from which the vat is fed.

The yarn is placed upon the sticks just in the manner

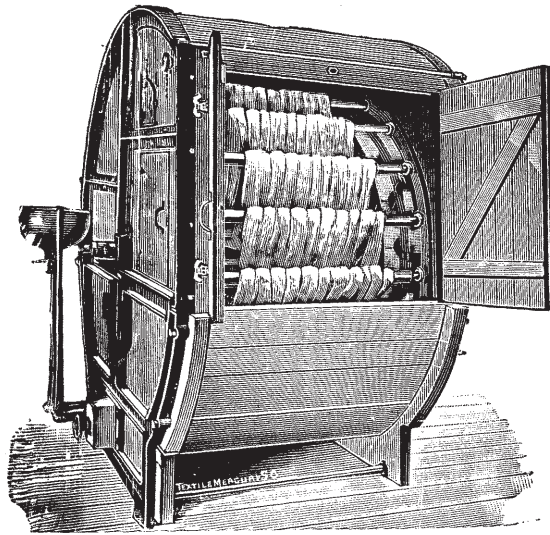

FIG. 170.—THE SAME CHARGED WITH HANKS.

it would be if turned by hand, and it is turned by an automatic trip which rings a bell if from any cause a skein or skeins should fail to revolve. In the event of such an interruption occurring, it requires but a moment to find the cause and correct it. A second set of sticks is furnished with each machine, so that whilst one lot is being dyed, another can be placed upon the second set to be ready for placing into the machine as soon as the first has been taken

out. This prevents the machine standing idle whilst the yarn is being got ready. It can thus be kept almost continually in operation, which is a great advantage. The machine can be rapidly charged and discharged, as 100 lb. can be put in or taken out in the short space of three minutes.

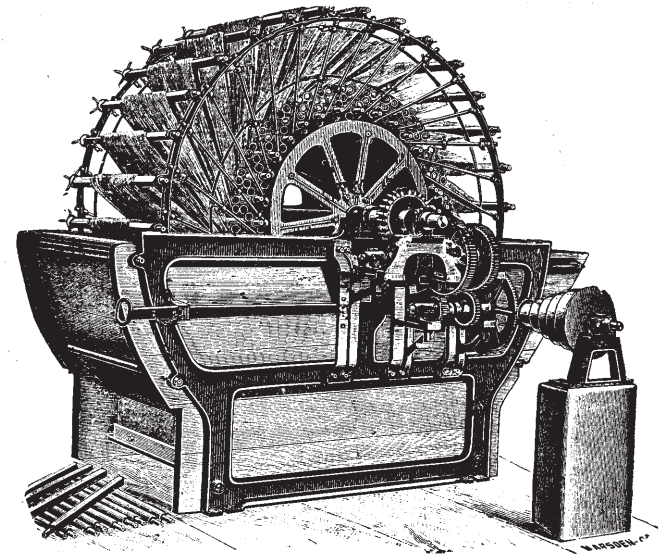

FIG. 171.—SHOWING GEARING-END AND COVER REMOVED.

In the larger machines the quantity can be increased to 300 lb., the time for dyeing being no longer.

The vat is charged with dye liquor from the pan on the left-hand side of the machine, figs. 170, 172, in which the dye-stuff is dissolved, and from which it passes into the vat whilst the machine is in operation. There is no need to withdraw the yarn from the vat whilst the fresh dye liquor is being added, as is the case in the skein-dyeing machines

generally in use. The revolution of the yarn cylinder quickly and thoroughly diffuses the added liquor throughout the vat, immediately making it all of uniform strength. When the machine has been charged, and sufficient dye-stuff has been added to match the shade required, no further attention is needed until the dyeing is finished

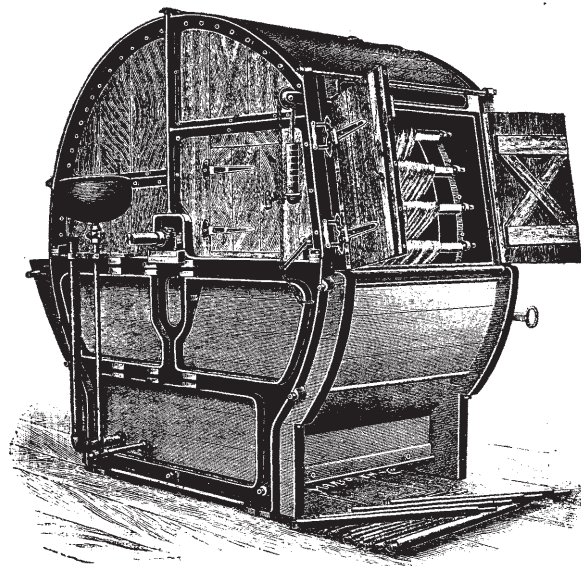

FIG. 172.—SHEWING FEED-PAN.

and the yarn is ready to be removed. Here, too, a gain of time results from the power of adding the dye-stuff without stopping the machine.

Having loaded the machines, the attendant can perform other work, and his boy assistant can attend to from two to four machines, having nothing to do after helping to load and unload until it is time to "take a matching off"

for the dyer to compare with his pattern. This is done as quickly as by the open vat process. It is part of the boy's duty also to attend to the alarm bell, but this may not be heard more than once in a week. The boy in attending to these machines does the work of many men on the old systems, and the gain from the saving of labour alone in one year will more than recompense the outlay upon the machine. Even in dyeing small lots the labour of the boy displaces that of two men.

In dyeing by open vats it is well known that the temperature cannot be raised above 204 degs. without the yarn being steam-blown and tangled, but in this machine, by its being enclosed as shown, it can be carried up to 212 degs. in the dye-bath, which obviously constitutes a very important gain. The additional heat accelerates the dyeing so much that as much work can be accomplished in five minutes as in the usual way can be done in fifteen minutes. The heat ordinarily wasted is thus much more perfectly utilized, and a large saving of fuel is effected, while the atmosphere of the dye-house is kept almost entirely free from steam. This fact alone is a great advantage, as it adds so much to the health and comfort of the workpeople.

Estimated on an average of the colours most in use, one machine will mete out and dye in ten hours 1,000 lb. of cotton yarn; it will dye 1,200 lb. to 1,500 lb. of worsted yarn; and of carpet yarn 2,000 lb. to 3,000 lb. Owing to the several points favourable to economy we have already described, there is a considerable saving of dye-wares, often to the extent of 25 per cent.

In economy of labour, in the saving of dye-stuffs, in the higher utilization of steam, in the greater production and the improved quality of work realized by the use of this machine, it will be obvious that dyers must realize a great advantage by its early adoption.

There are several other machines, known by the names of Boron, Corron, and Craven. These differ in both prin-

ciple and details, but there is no call for a description of them here.

In the various processes of bleaching, dyeing, or sizing yarns in the hank, it will be evident that drying becomes a necessity. But as quickness is always economical, it will be equally clear that to wait for the natural drying of wet yarns in the damp atmosphere of the English manufacturing districts, would involve a long delay and great uncertainty as to when it would be completed. This soon led to the drying of yarns in stoves heated to high temperatures. But the subjection of vegetable matter, such as the cotton of which the yarn is composed, the colours with which it is impregnated, or the starch and other materials with which it may be sized, is highly objectionable, as discoloration of the fibre is likely to take place, dispersion of the colouring matters to occur, or the baking of the starch, from all of which deleterious effects upon the yarns result. It becomes preferable, therefore, having in view the attainment of the best results, to dry the yarn whenever required by atmospheric means at a moderate temperature, and in as dry an atmosphere as can be obtained. A temperature of from 70° to 100° would do no harm, whilst from 100° to 200° might do much in tendering and discolouring the yarn, or baking the starch upon it. Care of course must be taken to get quit of the atmosphere in a drying room when it has become highly charged with the moisture liberated from the yarn, and this because its power of further absorption becomes correspondingly less. If the circulation of the air through the drying room is not satisfactory, it ought to be forced by the use of propeller fans.

In order to attain the advantages of quick drying free from the disadvantages of the ordinary method, a hank drying machine has been invented, which is illustrated in fig. 173. As will be seen, it consists of a cylinder almost like that of a reeling machine, in which, however, the yarn, instead of being arranged upon its periphery, has

one end of the hank passed around an external bar, and the other over a rod arranged to fit in a position near its axis. These bars and rods are loose, and the machine is furnished with two sets, so that one can be in process of loading, whilst the contents of the other are drying in the machine, thereby avoiding loss of time. The driving is at about 110 to 120 revolutions per minute. Under

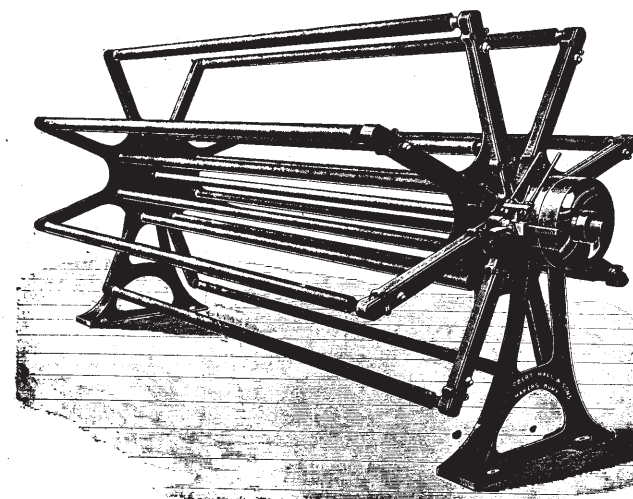

FIG. 173.—HANK DRYING MACHINE.

average conditions, one of these machines will dry from 400 lb. to 450 lb. per day of ten hours.

As this machine was first made, it was found that the portions of the hanks in contact with the bars and rods were not dried as soon as the others which were exposed to the free action of the air. To remedy this the makers have recently introduced an improvement, whereby the hank can be automatically traversed around the bars and

rods, so as to bring the protected portions under proper exposure, giving a uniform drying throughout.

By this method of drying the important qualities of softness, elasticity, colour, and finish of the yarn are preserved; there is a considerable saving of fuel and a diminished risk of fire; the dispersion of colours from one set of yarns and their absorption by others in the same room upon which they are not wanted is prevented, the yarns therefore preserving a brighter and fresher appearance through the absence of neutralization. Its use also results in a great saving of space. It is constructed to receive various sizes of hanks.

In yarn dyeing the dyeing of each colour is of necessity done separately, and the subsequent sizing process must be conducted similarly in order to prevent the running of the colours into one another, as they would do were they to be sized together. Hence the necessity has arisen for hank-dyeing, hank-wringing, and hank-sizeing machines, all of which are different from one another. Many colouring matters are of a very harsh character, and cause the threads to adhere considerably to each other, as, for instance, buff colours and others that could be named. The dipping of the hanks into the liquid bath also causes the threads to spread themselves, and when they are lifted out to overlap one another to a considerable extent. This necessitates a shaking or disentangling process, and where the threads adhere, brushing has to be resorted to in order to prepare the hank for the winding process. The stretching and brushing has, hitherto, mainly been done by men, at considerable cost in wages. To obviate this the machine illustrated herewith, fig. 174, has been invented. It is a combined hank-shaking, stretching, and brushing machine. It consists of two rollers, which are composed of copper, to prevent oxidation from contact with wet yarn. These, as will be seen, are arranged horizontally, one above the other. The top one revolves, and is positively driven. The lower one is free to turn upon its axis, and

is so mounted that in working it can be and is raised from its lowest position several inches by the revolution of a cam. When it has attained the top of this movement, it is permitted to fall without check or impediment, and this fall, which is arrested by the hanks suspended upon the top roller, shakes the latter, and re-arranges the threads in a more perfectly parallel order. There are

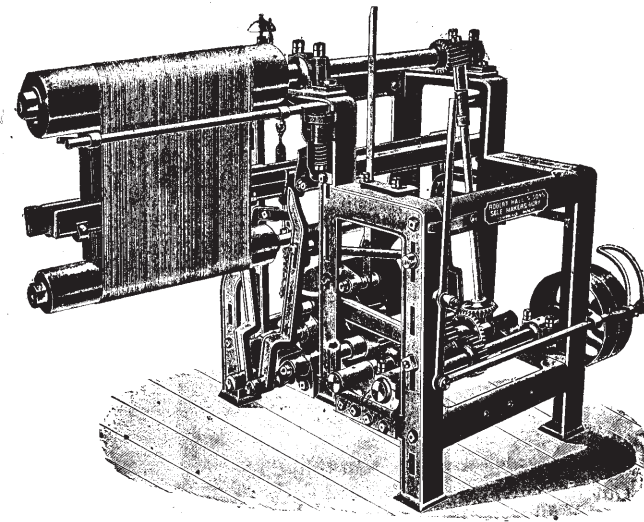

FIG. 174.—HANK SHAKING AND BRUSHING MACHINE.

also two flat reciprocating brushes, one passing through the hank, and the other outside. On the fall of the bottom roller, and while the yarn is held in a tense state, these brushes close upon it, and then move vertically downward, thus brushing the yarn upon both sides of the hank. All this time the yarn is revolving, being delivered from the positively-driven top roller to the bottom one. Of course the rate of movement of the brushes exceeds

that of the yarn, or no brushing operation would result. The yarn whilst undergoing this treatment spreads out upon the rollers, and would run off at one end, but this tendency, which simply proves the efficiency of the action of the machine, is controlled by a guard, shown near the top roller. This has two projections upon it, between which the yarn is confined. The machine is furnished with an indicator, which rings the bell when the hank has completed the one or more revolutions that may be necessary for sufficient brushing. When this has been given, the bottom roller is raised by a lever, the yarn guard drawn back, and the hanks removed. The machine is then again supplied with hanks, and the work resumed.

This machine has been specially designed to meet the requirements of the coloured branch of the cotton trade, and such others as proceed on similar lines, in which the yarn is chiefly dealt with in the hank form. Its purposes are for stretching and disentangling the yarn and for laying down the fibres upon its surface, all these being required to enable it to be worked with facility in the next process, that of re-winding. It is used with hank-sizing and hank-drying machines, and is very effectual for its purpose, as with it a boy can easily do the work of two experienced men who work on the hand system.

Cotton yarns are sometimes dyed in the condition of warps. This is done in a dyeing machine consisting of a series of three or six vats. Between each two vats are a pair of squeezing rollers. Guide rollers are introduced into each vat, the object of which is to cause the warp to pass up and down several times in the vat, thus securing repeated immersion and thorough saturation. The vats are filled with the dye liquor, and the warps passed between the guide rollers into the first vat; emerging from these they go between the squeezing rollers which press out the surplus liquor. This is repeated until every vat has been passed through, each passage being equivalent to a dip.

If one passage through the machine does not produce the desired effect, the operation is repeated.

Usually indigo is the chief colour dyed upon warps, as it is more tractable in warp dyeing than any other colour. Sometimes the warp is simply laid down in the indigo vat, allowed to steep a short time, then it is drawn out through a pair of squeezing rollers and over a winch. This is placed at some distance above the vat so that the indigo has time to become oxydized before the warp reaches it.

There is yet another form in which yarn is dyed, and that is the cop form as it comes from the mule. There has long been a strong desire to accomplish this in a satisfactory manner, but for a long time very little success attended the efforts made to solve the problem. Of late years, however, some considerable progress has been made, and it would appear that complete success is almost within sight if not already attained.

The advantages of dyeing yarns in the cop would be considerable. It would save the cost of the reeling process altogether, and it would diminish waste. The difficulties, however, seemed almost insuperable. Simple immersion of cops in a dye liquor, however prolonged, is not sufficient; for whether the saturation commences from the exterior surface or the interior by means of the spindle holes, or whether it is conducted by both of these ways at the same time, the dye liquor has to filter through the successive layers, and consequently as it approaches either surface it has become weakened and has less colour to impart to the last layer than it gave to the first. This is the case in whichever direction the process of saturation is conducted. It is also the same when operating in the two directions at once. Besides this the time required is very great. This, however, would not matter much if the result was satisfactory, which as the process has been usually conducted has not been the case. It has never been possible to get anything like a uniform shade of colour. The mechanical construction of the cop has pre-

vented this, the result having been that the exterior layers have been dyed of a full shade while the central portion has been quite white, grading from that through all the intermediate tints to the full colour of the outside layers.

During the past two years, however, two cop dyeing machines have been constructed which have attained marked measures of success. The first of these is of Swiss origin, the inventor being named Graemiger. The second is a Lancashire invention, that of Mr. Crippin, a Manchester manufacturer.

Graemiger's invention consists of a hollow drum which is fixed in a dye vat so that the lower half is immersed in the dye liquor. Internally this drum is divided by partitions into four segmental chambers, the two lower ones being connected with a centrifugal pump. One of the upper chambers is connected with an air pump. The third chamber is open. The ends of the drum are perforated. Against each side, and arranged to be in very close contact, are two discs which are also divided into segments corresponding to those of the drum and perforated in a similar manner with holes which correspond exactly in position with those in the sides of the drum. The cops are placed on perforated tubes of special construction, the ends of which fit exactly and tightly into the holes in the discs.

The action of the machine is this: the vat is fitted with dye liquor, heated by steam pipes if necessary, the pump is set in operation and draws the dye liquor through the holes in the drum which it returns to the dye vat. The top left-hand segment of the discs is filled with cops previously placed on the skewers. The drum is given a quarter of a revolution which immerses the cops in the dye liquor. The suction of the pump draws the latter through the cops. The next segment of the discs is charged, carried, and saturated in a similar manner, and the third is treated likewise. This brings the segment first immersed out of the dye liquor and into contact with

the right-hand segment of the upper half of the drum. The air pump in connection therewith draws air through the cops and exhausts the superfluous liquor. The process is then finished, the cops being usually sufficiently dyed. The revolution of the machine is partially automatic. Every lot of yarn put into the machine goes through this cycle of operations.

The cop dyeing machine of Mr. Crippin is constructed on different lines though embodying its leading principle, saturation of the cops by atmospheric exhaustion. This machine, illustrated in fig. 175, consists essentially of three parts: 1st, a dye vat or tank for the reception of the dye liquor, heated if required by steam pipes; 2nd, a dyeing chamber placed at one end of the dye vat with which it communicates; 3rd, exhaustion or receiving cylinders placed at the opposite side of the tank. The dyeing chamber is cylindrical in form, and is open at the bottom to the dye vat whilst at the top it communicates with the exhausting vessel mentioned.

In charging it the cops are placed on perforated skewers of a special construction. From 150 to 200 are skewered and fixed on a circular perforated plate termed the cop plate, which is placed in the cop chamber and is so constructed that when in position it divides the chamber into two portions. When the cover of the chamber is put on it presses tightly on a projection on the central part of the cop plate and keeps it firmly in position. By means of a steam injector a vacuum is formed in the exhausters, and by suitable connections this is communicated to the cop chambers, and by means of this the dye liquor is drawn from the dye vat through the cops and into the exhausters or receiving vessels. When a certain quantity of the dye liquor has been drawn through the cops, which is indicated by gauge glasses, a vacuum is created on the opposite side and the flow of the dye liquor is reversed, it being drawn from the cop chamber to the vat.

These operations are repeated four or five times when the

cops are found to be thoroughly dyed. Air is then drawn through them which forces out all the surplus dye liquor, the cop plate is removed from the chamber and the cops dried, which finishes the operation.

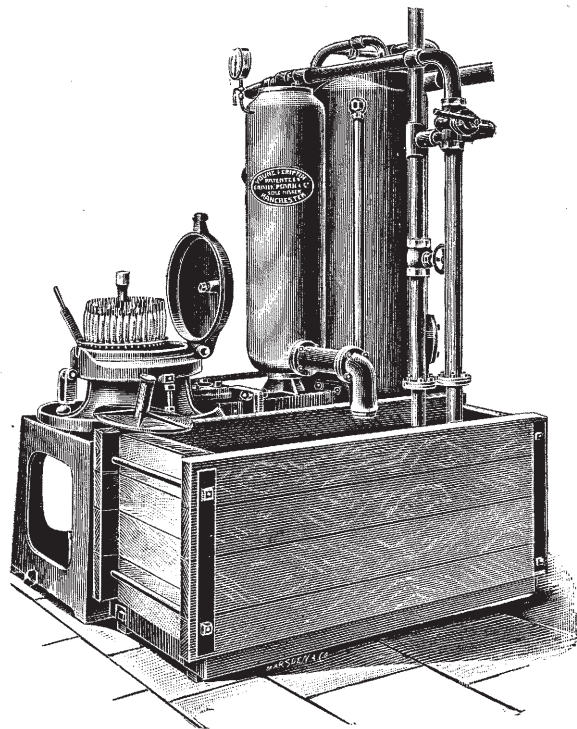

FIG. 175.—CRIPPIN'S IMPROVED COP DYEING MACHINE.

This machine works in an exceedingly efficient manner, and gives perfectly uniform shades in each cop and throughout all the cops of a batch, and all successive batches when the usual care is taken to keep up the strength of the

liquor; and this uniformity of shade throughout successive batches is a matter of considerable importance. It can be used very successfully in the dyeing of the direct cotton colours, such as benzo-purpurine, or the Titan colours. It may also be used in the dyeing of diazotizable colours, such as diamine blacks or browns, and also with basic colours, such as magenta and auramine, while with a certain modification in its construction it gives excellent results with indigo.

Cop dyeing is very rapidly effected with Mr. Crippin's machine. Five minutes is usually sufficient for dyeing a simple colour like benzo-purpurine, or Titan yellow; and twenty-five minutes will suffice for producing a diazotized diamine black. A basic colour like auramine takes ten to twelve minutes. Hitherto good results have not been attained with mordant colours like alizarine, but by the use of the Erban Specht process, or some modification of it, more success might result.

There are other cop dyeing machines, but they have not been a commercial success, and call for no further notice here. Those who are interested beyond satisfaction with what is given here may refer to a valuable paper upon cop dyeing by Dr. C. O. Weber, which appeared in the "Journal of the Society of Chemical Industry" in 1892.

It would be out of place in this essay to burden its pages with recipes for dyeing, but the author may be permitted to direct the attention of those interested in this department to the columns of the "Textile Mercury," in which the earliest and the most abundant information is given relating to new dyes, processes, and their practical application and values as judged from a workshop and commercial standpoint. This journal is issued weekly by Messrs. Marsden & Co., Manchester.

CHAPTER X.

THE DEVELOPMENT OF THE ART OF DRESSING OR SIZEING, AND THE MACHINERY EMPLOYED IN THE PROCESSES.

Sizeing: its meaning and purpose.—Early Indian sizeing.—The sizeing of Dacca muslins.—Indian size.—Early English size; a recipe.—Recent progress in size compounding.—The mechanical appliances of sizeing.—Hand warp dressing and drying.—Duncan's suggestions of improvements.—Hand warp sizeing.—Sizeing shops.—Warp-dressing in the power-loom.—Radcliffe's suggestions for improvements.—Johnson's invention of the dressing machine.—Detailed description, with improvements, *illustrated*.—Further improvements by other inventors.—Hornby and Kenworthy's tape-sizeing machine.—Kenworthy, the inventor.—His tape-sizeing described and *illustrated*.—Its distinctive merits.—James Bullough, the inventor.—Stimulation to invention.—Bullough, Walmsley, and Whittaker's invention of the "Slasher" sizeing machine, an improvement upon the tape-sizeing machine.—Improvements of the Slasher by Atherton, Kinlock, and Swainson, and William Garnett.—Leigh's "silica" size; results of experiments with it.—The Slasher sizeing machine of to-day; description and illustration.—The creel.—The size trough.—The boiling pipe.—The immersion, sizeing, and pressure rollers.—Importance of keeping the rollers in order.—The passage of the yarn.—The drying cylinders.—The headstock: the fan, the opening rods, the measuring roller, and the marker.—Ball warp and hank sizeing.—The hand hank-sizeing machine, *illustrated*.—The power hank-sizeing machine, *illustrated*.—Size for coloured yarns.—The systems of sizeing in use, and the causes of their maintenance.—Ball warp sizeing.—Dressing.—Slashing.—Hank sizeing in parti-coloured goods.—Cotton manufacturing, spinning, and weaving; the operatives.

IN the advanced stage of the art of cotton manufacturing, as it exists at the present time, sizeing is correctly regarded as the most important process of the series included in the second division of the trade which is the subject of this treatise. The nature of cotton yarn, which is composed of short filaments of vegetable down, loosely com-

pacted into a thread by spinning or "twisting," as it is sometimes called, renders some sort of dressing, or "sizeing," the meaning of which will be best understood if we take starching as its equivalent, necessary before it can be woven into cloth with any facility or satisfaction. In passing we may observe that cotton is not a "fibre," though commonly spoken of as such; this conception is a popular error. It is a vegetable seed down. Sizing is the application to the yarn of a starchy or glutinous composition, which passing between the loosely compacted filaments causes them to adhere firmly together, and thus the better to resist the strain and friction incident to the weaving operation. The strain arises in the formation of the shed for the passage of the shuttle, as explained at an earlier stage; and the friction in the passage of the warp over the carrier beam, under and over the lease rods, and through the healds and the reed. The severe action to which the yarn is exposed in the rubbing of the threads against one another, against the healds in shedding, by the friction of the reed in its movements to and fro, and by the passages of the shuttle through the shed, renders this protection absolutely necessary. Were single cotton yarns to be used without sizeing, they would soon fray and break, or ends of filaments or fibres, as we may call them for convenience, and which stand up above the common surface of the yarn, would break off, and gathering together would form "beads," or "runners," as weavers term them, behind the reed, which gradually getting larger would break down the warp threads. The process of sizeing lays these projecting extremities of the filaments upon the body of the thread, rendering it smoother, stronger, and much better fitted for its purpose than before.

There can be no doubt but that the earliest Indian weavers of cotton would experience these difficulties, and it is equally certain that there must have been a very early resort to a simple system of sizeing before much

useful result could have been derived from the attempt to weave it. Testimony to this effect is found in the Institutes of Menu, No. 397. "Let a weaver," says Menu, "who has received ten palas of cotton thread give them back increased to *eleven by the rice water*, and the like used in weaving, &c."

In the manufacture of the celebrated muslins of Dacca, a great deal of care was taken and labour made of this process. The yarn was steeped in water three days, the water being changed twice a day; then rinsed, reeled, dried, and then reeled off into skeins. These were again steeped in water, withdrawn, wrung between two sticks, and exposed to dry in the sun. The next stage was to untwist them and immerse them in water mixed with fine charcoal powder, lampblack, or soot scraped from the sides of an earthenware cooking vessel, in which they were left for two days. Being withdrawn they were rinsed in clear water and hung up in the shade to dry. These skeins were again reeled, and again steeped in water for one night, removed and spread out over a flat board and rubbed over with a size or paste made of coie paddy, or rice from which the husk has been removed by heated sand, and a small quantity of fine lime mixed with water. Such, very briefly stated, was the method of sizeing followed in Dacca as we are informed in "An Account of the Cotton Manufactures of Dacca in Bengal," by an English gentleman who resided there in the first half of the present century. It would be interesting did space allow to comment upon some of the particulars given by this writer, but the indulgence cannot be permitted.

In the ordinary processes of manufacturing in India it is hardly likely that such an elaborate method as that roughly sketched above would be followed. It is known, however, that rice has formed the basis of the size used in India from the remotest times, as the extract from Menu given previously sufficiently proves. As a rule it was what in an English home would be simply called

starch. In the manufacture of the muslins as described above, the subjection of the rice in the husking process to a treatment with hot sand might very probably transform the starch it contained into an impure dextrine, or British gum as it is now commonly called.

Elaborate and careful tests have been made of the percentages of size contained in cotton goods of the native Indian manufacture. Cotton Loongees were found to contain from 2.75 to 15.3 per cent.; cotton Sarees from 6.54 to 13.4 per cent.; muslins from 3.8 to 23.78 per cent., the remarkable fact in this instance being that the finer qualities contained the largest amount.

As previously shown, the English weaver of cotton began with and, for more than half a century, only used cotton yarn for weft, his warp being of flax. This required sizeing almost as much as cotton, consequently when he began to make his warps from Arkwright's water twist he was not quite a novice in sizeing. The materials most commonly used were wheat flour and potatoes boiled to the required consistency in water, and without the addition of the other materials now commonly employed. As the modern sizer well knows these would lay the loose fibres, consolidate the yarn, and give a certain amount of smoothness, but in the dry terms of the year, such as during hard frosts, dry winds, or hot weather, they would too readily part with their moisture to the atmosphere, leaving the warp harsh, dry, and difficult to weave. In the latter half of the last century the conditions of living were very different to what they are now; the fresh foods that are now procurable all the year round were not then to be had, and in some districts salted fish, and in others bacon and salted beef formed important staples of diet. In the preparation of these brine was extensively used. Some genius connected with the art of weaving was struck with the idea that the warp might be "cured" or rendered softer and easier to weave if a portion of fish, or beef brine, was added to the size. This was done with benefit, and its

use continued far into the present century. When these sources of supply began to fail a curious substitute was adopted: this was human urine, which was collected at the mills and works, and often from the public urinals in the streets in receptacles for the purpose. This was done up to as recently as 1850-60. It was then discovered that there was nothing essential in these liquids beyond the salt they contained, and as a consequence common salt began to be added to the flour and potato starch generally used, a corresponding disuse of urine following.

A considerable time previous to the above date, however, a good deal of crude experimentation amongst weavers and others interested was going on. Warp sizeing had become a separate business to a great extent, and every sizer made a different compound for the purpose which he kept as secret as he could from all competitors. The efforts made were chiefly directed to increasing and maintaining the softness of the warp during all conditions of weather and atmospheric changes. That these gradually led to a measure of success will be apparent from the following recipe of a size extensively used by good sizers in both England and Scotland in the years 1840-50.

“Take 1 lb. of Soft Soap,
 2 „ Tallow,
 2 „ Soda.

Mix them well with as much boiling water as will reduce the mixture to the consistence of cream—then take seventy or eighty gallons of water, milk-warm, put in it about 240 lb. of good flour, and then add the mixture, taking care to stir all well together; and in three or four days the size will be fit for use. It is then to be reduced as the work may require it on being put into the tub.”

From this it will be evident they were on the right track, but as yet a long distance from the goal. The lubricants, as the first three articles were termed, were

used in various other proportions by different sizers; to keep the cloth a good colour some substituted white soap for the soft.

We need not trace in minute detail the progress of the art of sizeing and the composition of size, as a brief summary will now suffice for the remainder of the review of the subject. The great progress that has been made during the past thirty-five years had its origin in the American Civil War. The cotton famine in Lancashire, induced by that event, completely disorganized the cotton manufacture, and the commerce in its products. The great trade with the Eastern world was conducted upon the basis of conformity to certain particulars. The staple articles had to be of given dimensions, contain specified numbers of threads of warp and weft in the inch of cloth, and to be of certain weights, or they were practically unsaleable. To the minds of Eastern consumers these weights formed almost a guarantee that the fabric contained a certain amount of cotton, and the piece of cloth under ordinary conditions could always be bought within a given range of prices. As cotton became scarce and rapidly advanced in value, compliance with these requirements became impossible, and disorganization of the trade quickly followed. Attempts were therefore made to make up the weight by the addition of extra size, which up to a certain extent was successful. But the limit of this effort was soon attained in the then state of knowledge of the subject. The inferior quality of the cotton that came into use, and the imperfect yarn it produced, would not carry a heavy weight of size, breaking down under the burden. Then again the size was badly compounded, and in the process of weaving a great percentage was rubbed off and wasted. Kaolin or China clay was the chief material introduced in addition to the previous ingredients, and being perfectly neutral from a chemical point of view, and divisible into the most minute state, it proved an excellent article for the purpose. The difficulty

was to keep it in the yarn, and this problem was not solved for some time.

We may now briefly glance at the mechanical appliances of sizeing in their course of development in this country. The earliest system of sizeing or dressing of the warp was that of the hand-loom weaver, who dressed his warp in the loom. Having prepared his size in the manner indicated previously, he rubbed a portion upon a brush about 18 inches long and about 3 inches wide, the brush being composed of the best black bristles. Taking a second brush of like dimensions, he worked the two together until the size placed upon them was evenly distributed. He then proceeded to the back of his loom, and began to brush the extended length of warp backwards from the lease rods to the beam, thus laying the loose ends of the filaments of the cotton upon the yarn in the manner best suited to its passage through the healds and reed afterwards. When this was finished the warp length just sized was wet, and could not be woven until dried. To effect this with more expedition the weaver introduced a wing-shaped fan, which he waved backwards and forwards over the damp warp. Still in wet or damp weather the atmosphere had little power of absorbing moisture, so another method of effecting the object was resorted to. This was the "drying-iron," a long iron bar with a flattened end, which would reach across the warp. The flat part was made red hot, and moved over the top of the warp, as near to it as could be got without touching it. Many a warp has been burnt across by the carelessness of the operator in letting it drop upon the yarn, when it would instantly go through, and sometimes falling upon the loose down beneath, set the contents of the loom in flames. It ought to have been moved about close under the warp, and it would have dried it more quickly and have avoided this risk. After the drying had been safely performed, the dressed length was again brushed, in order to separate any threads adhering together,

and a small quantity of melted tallow was brushed over it. As this process recurred at frequent intervals, it will be evident that further improvement was needed.

Such was the general process of warp dressing or sizeing at the beginning of the present century. John Duncan, who gives these particulars in his "Essays on Weaving," published in 1808 in a collected form, suggests that the process should be separated from that of weaving entirely, and whole warps sized at once, in order that the weaver might work continuously at his weaving. These suggestions appear to have borne fruit at an early or later time afterwards, for the hand-loom weaver began to size his own warp all at once by a domestic process, and in the mills containing power-looms dressing and sizeing machines were introduced. The domestic process, as carried on in the home of the hand-loom weaver, was, briefly told, as follows: A wooden trough, about 4 feet long, 14 inches wide at the top, 8 inches at the bottom, and 8 inches deep, was constructed. A pair of small rollers were inserted in each end of this trough, about half way of the depth. The warp was passed between these along the length of the trough through the next pair, and out at the end, sometimes through a bell-mouthed tube. As soon as the warp end had thus been passed through, the trough was filled with boiling size of the consistency of cream. Immediately the length in the trough was saturated, the weaver and his assistants would begin to draw the warp through, coiling it on a sheet behind them. To preserve their arms and hands from the scalding size, they put stockings on the former, and held thick cloths in the latter. When the warp was drawn through, it was extended upon the drying frame, made of two standards, joined by cross-pieces and having a number of horizontal pegs, extending from the front and back. The warp having been passed from one standard to another until it was all upon the frame, was thus exposed in the garden, lane, or village street to dry.

When the weather was unfavourable, it was dried indoors before a good fire. This system lasted as long, or nearly so, as the handicraft form of the industry. Towards the close, however, "putters-out," as employers were termed, began to relieve the weaver of this duty by sending the warps to be sized before they gave them out.

Parallel with this development sizeing became a business of itself, the sizers seeking their customers amongst the "putters-out," and small mills which had not set up plant of their own. The places where this business was conducted became known as sizeing shops.

Though the power-loom had been made a capable machine at the close of the last century, it could make no headway owing to the necessity of dressing the warp in the loom. Every loom required a weaver, and what with tending his loom and dressing his warp, he could make no more cloth—about 15 yards of, say, 60 picks per inch per day—than the hand-weaver. The over-production of yarn and serious depression in the spinning and weaving trade in 1799, compelled attention to this subject, and Mr. William Radcliffe, a manufacturer of Mellor, Derbyshire, about a dozen miles from Manchester, after struggling ineffectually to get an export duty placed upon English yarns, saw the promise of a remedy in increasing the efficiency of the loom. In his employ he had an ingenious weaver with very strong inventive capabilities, named Thomas Johnson. He called Johnson to his aid, and expressed a wish that he should set to work and invent some method of sizeing the entire warp before it was put into the loom. He had not long to wait for his reward. He succeeded in inventing the dressing machine, and on February 28th, 1803, he took out a patent for it, No. 2684. This was an invention which deservedly ranks very high in the annals of the cotton trade. The first part consisted of a beaming-frame, such as was described in its most perfect form in the preceding chapter; the second was the dressing machine proper, and which in its

principles and general outlines was the same as the more perfect machine he patented on June 7th, 1804, No. 2771, and which, with subsequent improvements, became the well-known dressing machine that served the trade so efficiently until superseded by the tape-sizeing and slashing-sizeing machines. As the machine which made Cartwright's power-loom a commercial success it may be described in detail, which is rendered easy by the fact that an excellent illustration of it is given in White's "Treatise on Weaving," published 1846, which we reproduce.

It should be premised that the handloom weaver's idea of warp-dressing was a process that should lay down upon the surface of the thread the ends of the filaments of the cotton that the spinning process had failed to control, and so prevent them gathering in the shed and forming runners upon the yarn, and ultimately obstructing the weaving so much as to prevent its being proceeded with. His idea, therefore, was to encase the yarn in a coating of starchy matter, which should fulfil the requirement mentioned. The succeeding theory, and the one which is now in vogue, is to saturate the yarn in such a manner that every filament shall be bound to its fellows, so as to constitute the whole a solid thread. The former served the purpose of the time in which it was in vogue; the latter more perfectly meets the needs of the present day. The essence of Johnson's invention was to perform this dressing of the yarn, literally putting a coat upon it, by a machine in the manner the hand-loom weaver had done it by hand; substituting, in fact, a mechanical for a manual process.

Johnson, in his first patent, endeavoured to do this by the use of circular revolving brushes, but it was soon found that the result was not nearly so good as that obtained from the hand process. The circular brushes were therefore abandoned, and a system of parallel brushing invented by him, in which the brushes were traversed in one direction in contact with the yarn, and withdrawn from it when being carried back to the point from which

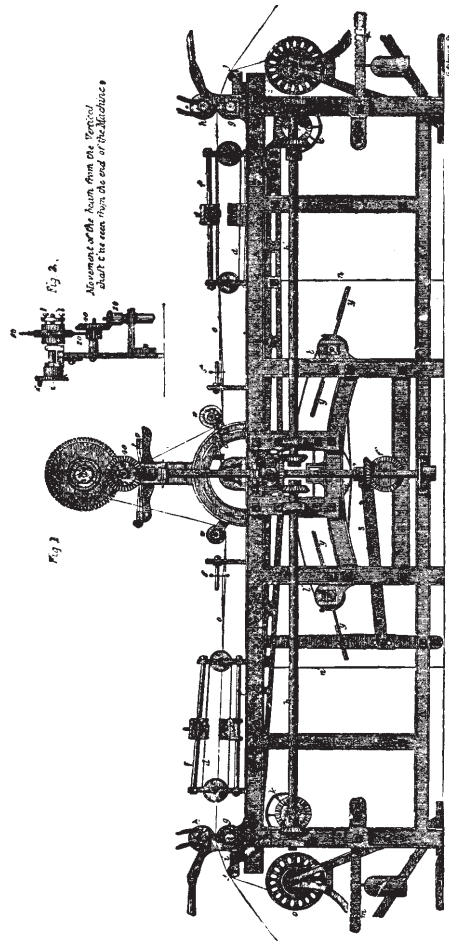

FIG. 176.—JOHNSON'S WARP-DRESSING MACHINE, IMPROVED.

a new stroke had to be made. This he accomplished by means of a crank-motion now familiar in the mechanical trades, and from which the machine ultimately got the name of the crank dressing-machine.

The illustration, fig. 176, and its description, will make Johnson's invention clear. It must first be observed that the machine is practically a double one, each part working to deliver its product to a common centre. The working parts are attached to or carried upon the oblong frame A. The oscillating brush-frame is marked *a*, sub-fig. 1, and extends the length of the machine, its pivot being in the centre. There are a pair of brushes at each end, *b b*, the upper one arranged to brush the top surface of the warp, and the lower to do the same for the under one. In their traverse the brushes operate upon the yarn when moving towards the ends of the frame. As the brushing was required to be in one direction, on their return to their first position, they were raised or lowered out of contact by the oscillatory movement of the frame in which they were carried, this being produced by the eccentrics *k*, which were set in opposition, so that whilst one elevated the end of the brush-frame as high as it was capable of doing, the opposite one permitted it to be correspondingly depressed. As will be seen from the same fig. when the brush frame end is elevated, the upper of its two brushes is carried out of action, and is making its return traverse to its working position. At the same time the lower brush is in action brushing the underside of the warp *c*. The left of the fig. shows the frame down and the upper brush at work, being the reverse of that on the right. As will be observed, the machine has a creel at each end, generally made to contain six beams, only one of which, *o*, is shewn on account of space. The unsized yarn, *c*, was drawn from these beams, and passing over a small carrier roller, was conducted between the two rollers, *g h*. These are the dressing-rollers. The lower one was half immersed in the dressing composition or size, and in its revolutions

carried enough of this to apply to the warp in its passage. The upper roller, which was driven by friction from the lower roller *g*, was a compression roller pressing the size into the warp, and squeezing out the surplus. The fact that the yarn was not immersed in the size at all is distinctive of the system of dressing as compared with the more modern one of sizeing, and, as will have been gathered already from previous explanations, proves its inferiority, and demonstrates the certainty that it would be superseded by the present system as soon as the merits of the latter came to be understood. The warp on leaving the dressing-rollers immediately came under the action of the brushes, the operation of which has been sufficiently explained, except that it remains to be mentioned that they were traversed backward and forward by the band *d*, to which they were attached, and which passed around the pulleys *e*, the latter being suitably actuated for the requirement. The yarn leaving the brushes passed beneath the conductor rollers *w*, which are also measuring rollers fitted with appropriate indicators giving the length. Leaving the measuring roller, the yarn passed upwards through the lease healds laid horizontally a little below the beam. The beam was placed at this height in order to get space in which to complete the drying of the yarn before it passed upon it. This was effected by means of two fans, one for each end, and steam-pipes.

As illustrated and described here the dressing machine contains numerous improvements in details added by succeeding inventors. As Johnson left it, there was no compression roller over the dressing roller, and the size was very crudely and unequally applied, and the yarn adhered very much together through unequal drying. Johnson made it to pass through a reed which improved it, but chafed it considerably, undoing the work of the brushes, whilst it was liable to fill up with pasty size gathered from the yarn in its passage. The difficulties were so great and apparently so insurmountable, that Johnson

advised his patron to abandon the attempt to make it a full success. Other inventors assisted in the task of its improvement, notably, Archibald Buchanan, of Catrine Works, Scotland, who in order to keep the threads from adhering, introduced a copper plate, perforated with holes, for the reception and perfect isolation of each thread, instead of the reed, which effected a great improvement. With further improvements in details and skill on the part of operatives, fairly good results were attained, and the use of the dressing machine divided the work to be done with the system of ball-warp sizeing that sprang out of the domestic system of the hand-loom weaver. It will, however, be obvious that though a very meritorious invention at the time of its birth, the dressing machine was very defective for its purpose. As first invented, the mass of warp threads was too dense for the brushes to penetrate, and they did the work very imperfectly. To remedy this it was divided into two portions, six beams being put at each end of the new machine, and their threads run together upon the loom beam, as shown in our illustration. This necessitated the duplication of every part of the machine making it, as we have termed it, a double one. But even then its work was imperfect and its production small, and totally inadequate to keep pace with the growing requirements of the trade. No wonder, therefore, that attempts soon began to be made towards a further advance.

The next most-important of these was the tape-sizeing machine. This was a Blackburn invention, emanating from Brookhouse Mills, which was patented in the names of William Henry Hornby and William Kenworthy. The first named was the proprietor and the second his manager, and subsequently his partner. Undoubtedly the latter was the principal inventor, both in this and subsequent inventions in which their names were associated. This machine marks the transition from the idea and principle of dressing entertained by the hand-loom weaver and by

Thomas Johnson, to the more perfect idea of "sizeing" or starching by thorough saturation, which has ever since governed the process. We believe Kenworthy was a native of Denton, near Stockport, from which place he migrated to Preston and thence to Blackburn. He would thus probably have acquired some knowledge of the condition of the art of sizing in the district where Johnson's inventions were in use. Becoming associated with Messrs. Hornby and Birley, of Brookhouse Mills, who were spinners, manufacturers, and ball-warp sizers, he would find full scope for his knowledge and inventive powers. These were subsequently exercised to considerable purpose.

The first important invention with which Kenworthy's name was associated was the tape-sizeing machine called the tape machine, from the peculiar mode of distributing or laying out of the warp threads, so as to get them dressed or sized in parallel strips or bands, the equivalents of the "beers" or "half-beers," which have been previously explained. This was accomplished by passing them through a comb-bar in those quantities in which state they somewhat resembled tapes of yarn. There was no particular merit in this arrangement of the yarn, but rather otherwise. It was, however, a distinct departure from, and an improvement upon, passing the entire of the warp in one strand through the size, as was done in ball-warping sizeing. It facilitated saturation of the threads much more perfectly than the dressing machine. The three accompanying illustrations over the general fig. No. 177 and under the sub-figs. 1, 2, 3, 4, 5, 6, fully explain this important invention. Sub-fig. 1 is a plan, 2 a side view, and 3 a longitudinal section; 4, 5, 6 show details. Unquestionably the inventor was indebted for some suggestions to both Johnson's dressing machine and the ball-warp sizeing plant as it then existed, as several points from both are incorporated therein.

The machine, it will be seen, consists of the oblong frame A, which as usual forms the support for the work-

ing parts. The beams, A, contain the yarn to be sized, and are placed in the creel of the machine. From them the yarn is led to the sizeing troughs, of which there are two arranged one behind the other and marked—first passing through a ravel or comb *b*, in fig. 3, and shown detached in fig. 4; figs. 5 and 6 show two other forms of the same thing. Next going over a small carrier roller, the yarn descends into the sizeing trough or box carried down by the rollers *e g*, *e' g'*, the direction of its movement being shown by the arrows. The rollers, *g g'*, press out the superfluous size from the yarn as it leaves them. The drying is effected by the two tin cylinders, which are steam heated. In order to get a longer stretch and more time in which to dry the yarn, it is conducted, as it leaves the size, first to the more distant cylinder, returning over it, and then passing around the nearest, which it leaves to be conducted over the carrier-rollers, *m, n, o*, to the yarn beam P in the front.

The tension upon the yarn is regulated by the pressure between the two receiving and delivering rollers, *e g*, *e' g'*, in the sizeing-box, through their connexion with the lever 11. The racks 14, carrying the pivots of the upper rollers, can be adjusted from the winch-handle through the small pinions, 13. The weighted lever, 2, is for regulating the pressure upon the delivery-rollers.

Perhaps the most novel feature in the machine was its sizeing the yarn in bands or tapes like "beers" and "half-beers," and passing it upon the beam in this manner like the old ball-warp was passed upon the weaver's beam from the beaming machine. This was mistakenly thought to be its most important merit, and therefore it was termed the tape-sizeing machine from it. Its greatest merit, however, really was in its being a sizeing machine, and immersing the yarn completely in the size. It was erroneously thought that the formation of the yarn into these bands or tapes strengthened the threads by causing them to adhere slightly together during their passage over the space

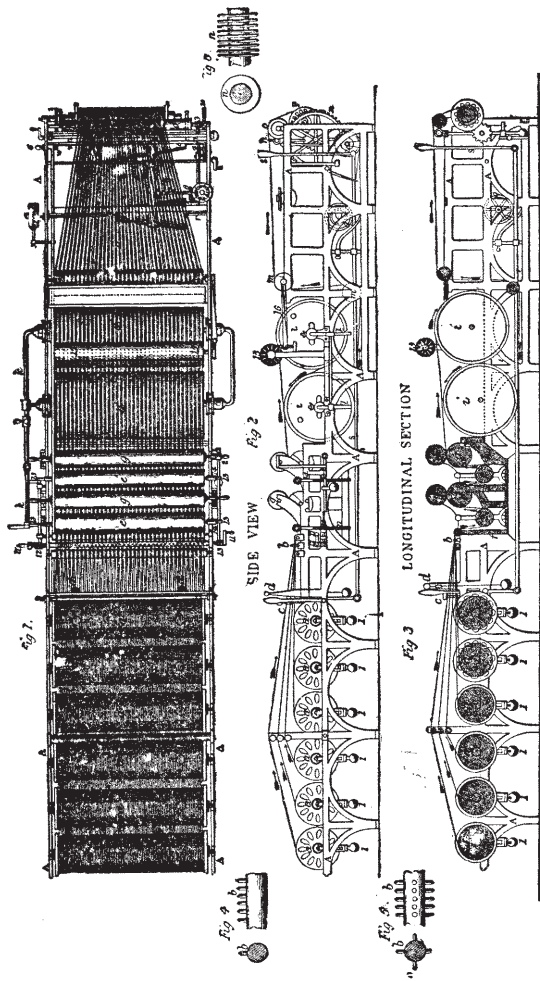

FIG. 177.—VIEWS OF ORIGINAL TAPE-SIZING MACHINE.

between the warp-carrier beam in the loom and the healds, their next resting place. This, however, was not so, as when the threads arrived at the lease rods and were separated, and shedding commenced, the strain upon them was at its maximum, and the weakest places were then found out and broken as each individual thread was separately tested.

The comb or ravel *b*, previously pointed out as effecting this division into tapes, was caused to vibrate or oscillate freely as the warp passed over it. The roller, *o*, was the measuring roller, its axle being furnished with a worm, which through the bevels, 5, 6, drove the shaft, 7, which again carried the worm, 8, this being the marker which touched the yarn with colour to indicate the piece lengths. The shaft *r* was the main shaft, which was furnished with the usual fast and loose pulleys, *s* being the starting handle.

One of the most excellent features of this machine, and which, with perhaps the exception of a short interval, has been retained ever since, was its possession of a variable driving arrangement, consisting of two cone-drums to regulate the winding action of the receiving beam, according to its varying diameter. The action of these we need not stop to explain, as to-day they are sufficiently well known. The shaft, *v*, carrying the driven cone, was furnished with a pinion, *w*, which drove a train of three spur-wheels, *x*, *y*, *z*, by which rotary motion was imparted to the beam. As the warp, now properly sized and dried, approached the beam from the roller, *m*, it passed through the ravel, *n*, which was generally used as a condenser to bring its breadth within the width between the flanges of the beam, *c*. For a while at first the arbor of the beam was sometimes made hollow, the hole being square, in order that if required it could be slipped off like a bobbin from a spindle. This was done in order to facilitate the placing of two beams together on a common arbor in one loom when it was desired to make a wide cloth. They

were thus joined without any trouble, and in working were paced together.

In the plain cloth trade, that is, in all sections in which plain warps of the natural colour are used, the machine just described has been the basis of all subsequent improvements. No attempt having the shadow of a chance of success has been made to supersede it. All efforts that have proved of commercial value have been to improve it by simplifying or perfecting its details. The first important advance made upon it was that of the late James Bullough, founder of the great machine making firm of Howard and Bullough, Accrington. Mr. Bullough was for a considerable number of years an overlooker in the establishment of Messrs. Hornby and Kenworthy, Brookhouse Mills, Blackburn. Mr. Kenworthy was the managing partner in that establishment, and in his early experiments, it is stated, availed himself to a considerable extent of the inventive skill of Bullough, whom he called in to assist him. Mr. Kenworthy also encouraged him to work out the details of his own inventions, for some of which he became celebrated, and from them derived the means that ultimately formed the foundation of the Accrington machine making establishment already mentioned.

The decades of the present century from 1830 to 1880, during which the transformation of the cotton trade from a manual to a mechanical industry was taking place, offered promises of great rewards to successful inventors, and the greatest in the first thirty years, when there was most to be accomplished. Hence in every centre of the industry large numbers sprang up, though most of them were failures. But the records of their efforts are preserved in the Patent Office, and there the inquiring student will find the wrecks of thousands of mechanical absurdities. Judging from the traditions that have survived, if any reliance may be placed upon them, which should not be much, there was a great deal of unscrupulous cribbing of ideas from one another, then quick races to the Patent

Office in order to be first. Thus it often happens that the inquirer into the development of the mechanical side of industry is baffled in his desires to allocate the credit for an invention to the right person.

James Bullough was one amongst a group of these men, and in the improvement of the sizeing-machine to which we are referring, he had as joint patentees with him two men named John Walmsley and David Whittaker. Justice demands that the names of these men should be mentioned. Bullough, however, having already achieved a reputation as an inventor, his name naturally enough became the predominant one in association with the invention of the Slashing, or Slasher Sizeing Machine, as the improved form came to be called. The patent for this was numbered 2,293, and was granted, October 7th, 1853. The improvement effected was practically a very simple one, but it had important effects in greatly increasing the production of the machine. In Kenworthy's machine, as we have just seen, the yarn was conveyed from the large yarn beams through a reed, healds, and ravel, which were only introduced to comply with the supposed requirements of the sizeing process, as shown in the dressing machine. Bullough discarded these, sending the yarn forward and down into the sizeing trough in a perfectly even sheet as it came from the beams. This greatly accelerated the work of "setting in," avoiding the loss of time common to the older machine. In order to preserve the lease it was necessary, in commencing the sizeing of a new set of beams, that the yarn of each beam should be twisted to the ends of the finished one, precisely as a new warp is now twisted to a set of healds. This could only be done in the machine. The loss of time will be obvious. The same patent includes improvements in the warping mill in which it was endeavoured to take the lease at that stage, and also mark the cut lengths. These, however, were soon after abandoned, and a method adopted of getting a bastard lease by striking a comb into the sheet of the extended warp.

This was sufficiently good for the purpose, satisfying all requirements of the case.

Since Bullough's invention this type of sizing machine has not been attempted to be superseded with any prospect of success for cotton work; it has, however, been considerably improved in details by various succeeding inventors. A bare enumeration of a few of these must suffice.

In September, 1854, three joint inventors named Atherton, Kinlock, and Swainson, we believe of Preston, relieved the great strain upon the yarn by inventing a method of positively driving the steam cylinders and the squeezing rollers instead of by the drag of the yarn. They also applied the frictional arrangement of the old dressing frame for winding the yarn upon the loom-beam. These formed very considerable improvements as the elasticity of the yarn was thus preserved until it reached the loom, where it was needed in the action of shedding.

Within a week or two of the above patent being granted another was taken out by William Garnett, presumably of Low Moor, near Clitheroe, for the improved way of taking the lease by "striking" a half reed or comb into the warp, as previously mentioned.

Atherton and Kinlock, early in November, carried their previous improvements a little further. In the new arrangements the squeezing rollers, rotatory brushes, and the traction rollers in front of the cylinders, were actuated by gearing, "so as to take off all strain from the yarn." Several other details were also improved.

Nothing further occurred that can be called noteworthy in connection with this subject until April, 1856, when John Leigh of Manchester patented what became known as "Silica-size." This was one of the most daring inventions ever attempted in connection with this subject, and as the experiment, so far as weaving with it, came under the writer's personal notice nearly throughout its course, a few words may be devoted to the subject. The invention consisted in the substitution of silicate of

soda, or silicate of potash, for the sizing compounds then in use. These were to be used either alone or in combination with sulphate of barytes and the various starches. They were mostly tried alone. Almost two years were spent in experimentation. In 1858 room and power was hired in Jubilee Mill, Blackburn, and an effort was made to place the invention upon the market. Fifty looms were bought, and placed in the charge of Mr. Edward Whittlo, the first secretary of the Blackburn Power-loom Weavers' Association, who had just vacated that post. Great difficulty was encountered with the new size, as the yarn after it had gone through the size was found to have a most destructive effect upon the drying cylinders, which being composed of tinned plates had the tin stripped from them in a very short time and were rendered useless. It was attempted to overcome this by the substitution of one or more steam chests for the drying cylinders of the sizing machine, so that the yarn might not come in contact with metallic surfaces. This was patented by Thomas Leigh, the brother of John. But the difficulties were not overcome. The yarn was got through the sizing process, and passed to the loom. Here it cut down the healds to such an extent that they were worn out before a piece of an 8 $\frac{1}{4}$ lb. Indian shirting, or what should have been such, was woven. This, of course, was inadmissible. The cloth when woven weighed pounds beyond the proper weight, and felt cold and greasy to the touch. The struggle was continued for some months, when the inventors finally failed with very heavy liabilities which had accrued during the conduct of the experiment. The highest hopes were entertained of its effecting a perfect revolution in the trade, but all were dashed together. The looms fell into Whittlo's possession, and he struggled on some time as a manufacturer in a small way.

The Slasher sizing machine was subsequently improved in numerous further details by succeeding inventors, the chief efforts being directed to securing a uniformly even

delivery of yarn from the back beams in both length and tension, and to relieve it from all strain or stretching in its passage; to prevent the baking of patches of size upon it when the machine was stopped, and to perfectly dry it before it reached the loom beam; to mark the piece-lengths accurately, and to press the beams in order to make them hold more length and to preserve their cylindrical form. The latest piece-marker and a presser will be described further on.

The addition of the improvements just indicated have brought the sizing machine up to its present degree of excellence, and as now made it is illustrated in fig. 178. A brief description, after the preceding sketch of its development, will suffice for all purposes, as the function of each part named will be readily understood. The portion of the frame on the left of the figure is termed the creel, and carries the series of large warping machine beams, called "back beams" from the fact that they are placed at the back of the sizing machine as here shown. These creels are usually made to hold six or eight of these beams, generally in two tiers, whilst any less number can be worked. By the addition of a portable stand at the extreme end another beam or two could be added if needed, which will, however, hardly ever be required. The beams are generally placed in the creel to unwind in opposite directions, the yarn of the first to come off at the top and passing down under the second, which is in the lower tier; the yarn from both then comes upward and passes over the top of the third, and taking the contribution from this beam, it passes down under the fourth, bringing the yarn of that beam also with it. This goes on to the last beam of the set. The arrangement described secures a uniform delivery of yarn from each beam, which is an important matter in the subsequent process of weaving, where the tension of every thread in the warp as it comes off the beam must be as nearly as possible uniform if good work has to be made. The yarn from

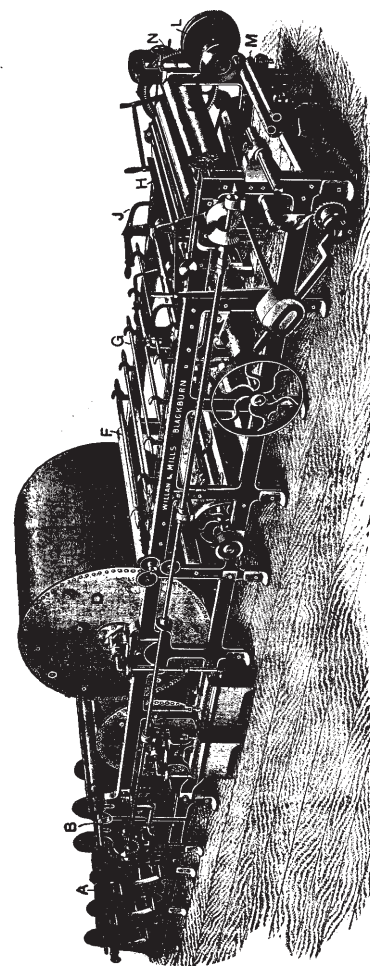

FIG. 178.—THE IMPROVED "SLASHER" SIZING MACHINE.

each beam having been gathered together in this manner, it passes over two small tin carrier rollers in an even sheet, and descends into the size trough, B.

This trough is divided lengthwise into two unequal portions, the smallest being nearest the steam cylinders. The partition does not go to the bottom, as a space is left for the passage of the contents of the smaller one into the larger. The smaller one is a sort of reservoir for the larger one, and it receives the size direct from the beck in which it has been prepared. The object of this indirect feeding of the size to the trough in which it is applied to the warp is to prevent the raw size coming into contact with the yarn before it is properly boiled. The first stage of boiling is therefore commenced in the small trough, and as it is drawn from this into the large one at the bottom, the boiling is completed before it rises into contact with the yarn passing around the immersion roller. We have before observed that this boiling bursts the granules of the starchy matters in the size, reducing them to a much finer condition than before, and therefore making the composition all the more fit for application to the yarn. The admission of the size to the small section of the trough is automatically regulated by a ball tap, and so requires no attention, after being adjusted, to keep up the proper supply or to prevent over-filling.

Along the length of the bottom of the larger section of the trough is fixed a steam pipe, sometimes in a single length and sometimes made double by being forked. This is perforated with a large number of small holes, and is suitably connected with a larger pipe from the boiler. When the tap is opened and the steam admitted it forces its way into the size-box, and soon causes its contents to boil freely, by which the size is brought to its finest condition.

This section of the size-box contains a series of rollers. Enumerating them from the position nearest the creel they are as follows: 1st, the immersion roller; 2nd, the

first pair, called the sizing rollers; and 3rd, the second or pressure rollers. The immersion roller is composed of copper, and is about five in. diameter. Its function, as its name implies, is to carry the yarn down into the size. By means of a rack and pinion it can be adjusted at any depth in the trough that the work in process may require. This differs according to the counts of yarn and the number of ends contained in the warp. Coarse counts or a large number of ends in the warp require deeper and consequently longer immersion to obtain thorough saturation than fine counts and few ends.

The sizing rollers come next. The bottom one is like the last-named, composed of copper. The top one is of iron, and is covered with two or three layers of flannel, and these with a layer or two of calico. This clothing is to form a cushion into which the yarn can imbed itself in its passage between them. These rollers are correctly termed the sizing rollers, as their function is to press the size, which to some extent is lying upon the surface of the yarn, into its core. The yarn imbedding itself into the clothing of the top roller receives a gentle pressure upon every side, which forces the size into it, and thus fills the interstices between its filaments and perfects its saturation.

The pressure or finishing rollers are the next pair, and are constructed in like manner, and again the bottom one is of copper and the top one of iron, the latter being clothed, but not usually so thickly as the preceding one. The function of this pair is to press out of the yarn all the superfluous size it may have absorbed or be carrying on its surface. The weight of the top roller is varied sometimes by the quality of the work it has to perform. If it is required to press out of the yarn a large percentage of the size absorbed, it may be temporarily weighted for the occasion. When light, it will press out a less quantity of size and the warp will be the heavier.

The immersion roller and the two bottom rollers of the

pairs are made of copper in order to resist in a better manner the action of the acids generated by the fermentation of the size and which are always present in it. Formerly the first bottom roller was made of wood, because it was found that when of copper it absorbed so much heat from the boiling size that if the machine was compelled to stop for a short time, the size was baked upon the warp, which was thus seriously damaged at that spot. The wood roller never absorbed heat to this extent, but it had other defects, as it soon displayed signs of wear and was difficult to keep in good condition. As the defect of size-baking generally occurred in the stoppage during the doffing of a filled loom beam, to overcome it an ingenious device was invented by which the attendant was enabled to run the machine very slowly while doffing instead of making a perfect stop. This did not allow the yarn to remain upon the hot roller long enough to bake, and thus the difficulty was obviated, and the copper roller was reintroduced and is now found in all good machines.

It is important that all these rollers should be kept in good condition, as upon their proper clothing, cleanliness, even surfaces, and easy working, depends in a great degree the perfection or otherwise of the work going through the machine. The two top rollers are surface driven, the bottom ones being positively driven from the side shaft.

The yarn passes from the beams over two tin carrier rollers, and descends to a more or less depth in the boiling size under the immersion roller and up therefrom to and between the sizing rollers, the superfluous size being pressed out and flowing back into the trough. Having passed these, it proceeds to and between the next pair, where any superfluous size that may remain is squeezed out, and the sizing process is then completed.

The wet yarn now passes directly upon the large cylinder, *D*, which is heated by steam and is generally worked at a pressure of from 5 to 15 lb. per square inch according to the counts of the yarn and the number of ends

in the warp. This cylinder slowly revolves, the yarn passes over its top, around its front and under its bottom, thus almost encircling it, whence rising it is delivered to the small cylinder, *E*, around which it passes in like manner. The latter cylinder is steam-heated like the first. The sheet of yarn in its passage around the large cylinder has one side only in contact with its heated surface, which of course results in one side being more perfectly dried than the other. The second cylinder is therefore introduced to perfect the work, which is accomplished by delivering the damp side of the sheet of yarn directly upon it. This cylinder is of smaller dimensions because it has only about one third or one quarter of the work to perform that falls to the share of the large cylinder. The yarn on leaving the small cylinder travels a little above the floor to a small carrier roller on the same level, near the front of the large cylinder, thence ascending to and over the tin carrier roller, *F*. The second stage of the passage of the machine, the drying of the warp, has now been completed.

As might naturally be expected, the yarn having passed through the size and the drying process in a sheet, the threads are found adhering together. It would not do for the warp to go to the loom in this condition, therefore they must be separated. This is effected by the series of iron rods, *G*. In commencing a set of beams the sizer inserts a cord between the threads of each beam so as to separate the yarn of every beam from that of the other. These cords passing through the machine, come up over the carrier roller, *F*, and by their means the rods, *G*, are easily inserted in their proper place. The threads must now separate or break; they do not often do the latter as the adhesion is not strong enough. In order to cool the warp and perfect the drying, a fan, which is rapidly driven, is introduced beneath the warp at this point. The yarn now passes forward towards the loom beam, but before it arrives thereto it is measured by a roller—around which it passes and is marked at certain distances in one, two, three, or four

lengths to a piece, which indicate to the weaver the places at which to insert "headings," "middlings," or as in dhooties, cross borders, or other decorative additions as may be required. The lengths are determined by the number of revolutions of the measuring roller, which is 14.4 in. diameter. There are a number of adjuncts consisting of improvements in details beyond what have been remarked upon in this brief sketch of the sizing machine as it is to-day. They, however, will be more properly noticed in describing the practical working of the machine hereafter.

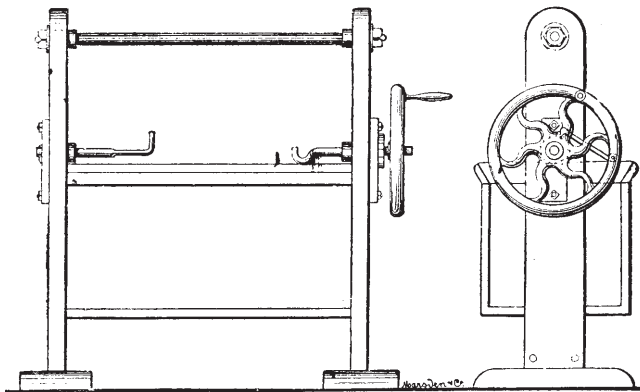

FIG. 179.—HAND-POWER HANK-SIZING MACHINE; FRONT AND END VIEW.

The next and last system calling for notice is that of hank-sizing. This is generally adopted where warps are composed of yarns of different colours. In these cases the yarns are first dyed in the hanks, and afterwards sized in the same state. Hence there are hank-sizing machines for working by hand or power, according to requirement. In principle there is little or no difference between them; it is mostly in magnitude and capacity of production.

The hand-power hank-sizing machine is illustrated in fig. 179, a front and end view being shown. This

machine is used for very small quantities and for samples. The box suspended in the middle of the frame is the size trough, and in this the hanks are placed until saturated. When this has been properly effected, they are taken out and each hank placed upon the two hooks shown, twisted, and the superfluous size wrung out of them. The number of turns to which the hank is subjected determines the amount of size to be left in. More turns compress out more size, fewer turns less. The hank is then removed, and the process continued.

In the larger power machine shown in outline in fig.

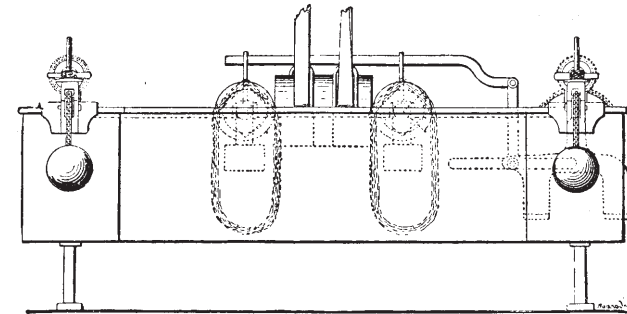

FIG. 180.—STEAM-POWER HANK-SIZING MACHINE.

180, substantially the same process is gone through on a greater scale. As will be seen, the hanks revolve in the size. The machine is furnished with an automatic wringing and reversing motion, which can be regulated according to requirement. It is constructed with either one or two pairs of hooks. With one pair it gives a production of about 25 lb. to 30 lb. per hour; with two about double that.

Fig. 181 illustrates another type of machine, but which embodies the same principles, though the arrangement is somewhat different. In this case there are six pairs of hooks placed on circular revolving discs. It requires a

man and a boy to attend to it. The boy immerses the hanks at the end of the machine, and they are carried forward upon small poles placed on a pair of endless chains. The man places the hanks upon the pairs of hooks in succession. In the course of one revolution of the discs, these are wrung and unwrung automatically; then the hanks are taken off and the machine charged

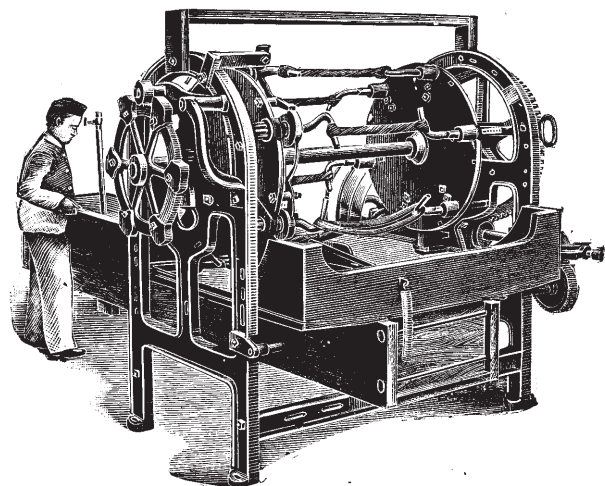

FIG. 181.—IMPROVED DISC HANK-SIZEING AND WRINGING MACHINE.

again. This type of machine gets through a great deal of work, the production per day of ten hours being from 1,200 to 1,500 lb. It is largely used in the Lancashire districts weaving coloured goods.

The size used in these machines, and for coloured yarns generally, differs from that used for grey goods, as it is essential that the colours of dyed yarns shall not be injured by any chemical constituent of the size, or dulled by its opacity. Directions are given subsequently.

When the hanks have been wrung out of the size they are placed upon horizontal poles to dry, or where the yarn drying machine described in the last chapter is in use, they are passed thereto and dried upon it. Running at about 100 to 120 revolutions per minute, and with the room in which it is placed heated to a temperature of about 100° F., the production of dried yarn, 20s to 36s, from the machine will be 400 to 450 lb. per day of ten hours.

After drying the hanks are taken and brushed either by hand or by the machine already described (fig. 174) in the previous chapter. The production of brushed yarn from this machine, with a lad attending it, will be about 1,000 lb. per day of ten hours.

The various systems of sizeing and their development have now been passed under review, and the student will, we trust, have been able to gather therefrom the reasons which called them into existence, their functions, and their respective merits, and the requirements which have led to their maintenance or induced their supersession. In one form or another, however, they nearly all survive to a limited extent as specialties, and at these a glance may for a moment be cast.

The old system of ball warp sizeing is now very little used in the plain or grey cloth trade. It maintains its ground, however, in the manufacture of coloured goods where the whole warps are dyed in one colour, and in the manufacture of cords, moles, and other kinds of heavy fustians. In the districts where these are produced, it is still conducted as a separate business on account of the bulk and costliness of the plant, and the requirement for its economical working.

As just indicated, the old system of dressing is still in use for the fabrics stated, but this is only to a very limited extent.

The Slasher system of sizeing is in use for all the lighter classes of self-coloured fabrics, usually termed grey goods,

with the few exceptions previously named where dressing is retained.

Hank-sizeing prevails in the coloured goods trade in nearly all cases where coloured yarns are mixed.

This brings to a close our exposition of the invention, progressive development, and functions of the chief mechanical appliances used in the series of processes comprehensively, but erroneously grouped under the name of "cotton manufacturing," terms which properly include the spinning division as well. The trade in its entirety should be called "the cotton manufacture," and its two principal divisions "cotton spinning" and "cotton weaving;" these, of course, having their subdivisions. The persons following the first pursuit as employers should be called "cotton spinners;" those in the second "cotton weavers," not manufacturers. The operatives engaged in them should be respectively "operative spinners" and "operative weavers," and those of the subdivisions should bear the names of the sections in which they are engaged.

The reader who has followed our exposition up to this point will have few difficulties in the practical part that follows, as he will at once comprehend the reason why and the purpose of everything that is done, and will be ready at once to pronounce whether it is in accord with, or contradiction of, the basic principles of the particular process in which it appears.

The reader will observe that throughout this chapter we have spelt the word "sizeing" with the vowel e in the middle, which is not the common method to-day. It is, however, we believe, strictly correct and according to the best analogies of the language. During the last century and the early part of this, the word "sizing" meant to assort yarns from hand spinners into sizes so as to get some approach to uniformity. This ceased with the improvement of spinning machinery.

CHAPTER XI.

THE CONSTRUCTION AND EQUIPMENT OF A WEAVING ESTABLISHMENT.

Cotton "manufacturing," its trade and technical signification.—Proportionate capital employed to wages paid.—Selection of locality and site of premises.—Causes of concentration in towns.—Essentials of success.—Requisite conditions and circumstances.—A humid location best.—Traffic and industrial conveniences.—Materials of construction for buildings.—The weaving process should be upon ground floor.—Arrangement of light.—Plan of weaving establishment, *illustrated*.—Location of the machinery.—Rope-driving *versus* wheel-gearing.—Supplementary engine.—Steam generating arrangements.—The Lancashire boiler with Galloway tubes, *illustrated*.—Increased economy desirable.—Tentative improvements, *illustrated*.—Mechanical stokers.—Mechanical stoker feeder, *illustrated*.—Economizer, *illustrated*.—Improved boiler valves, *illustrated*.—The steam engine, *illustrated*.—Gearing, shafting, and pulleys, *illustrated*.—Swivelling bearings, *illustrated*.—Toothed gearing, belts, and ropes.—The introduction of rope-driving into Lancashire.—Best material for driving ropes.—The strain and flexure of driving ropes.—The Lambeth rope, *illustrated*.—Its peculiarity of construction, tensile strength, flexibility, and inelasticity.

COTTON "manufacturing," in its trade and technical signification, is the second great division of the cotton trade, as "spinning" is the first. It commences to handle the material at the point left off in the latter. For various economical reasons, as partly explained in the preceding chapters, it is to a large extent conducted as a separate business from spinning. This, however, can only be done with advantage where the two branches are highly developed, and closely concentrated side by side, as in the English manufacturing districts. But the modern spinning mill is not so dependent upon the proximity of the weaving mill as the latter is upon the spinning mill,

because a spinning establishment may be usefully and profitably employed in the production of yarns for the export trade, which as a rule are destined for consumption in countries where the primitive industry of hand-loom weaving still maintains a lingering existence. Thus it is that in foreign countries, such as those of the continent, Canada, the United States, and the various States of South America, the two divisions of the trade are more often found conjoined than apart. In Bombay this remark partially holds good, though there, notwithstanding the spinning industry was founded to supply the hand weavers of the country, the tendency to separate has not only become manifest in the cases where the two were associated, but has made some progress. Should the cotton trade in the future in any of the other countries just named attain large dimensions, and become concentrated, there can be no reasonable doubt but that the same causes will operate there as here, and produce the same results—its separation into two divisions. In this treatise the subject is considered from the point of manufacturing having a separate and partly independent existence.

In proportion to the amount of capital invested a weaving establishment employs a far larger number of workpeople, and pays a proportionately larger sum in wages than one engaged in spinning. This renders skill and tact in dealing with workpeople of much more importance than in the first division, as there is a correspondingly greater liability of misunderstandings and ruinous disputes arising, which should, if possible, without the sacrifice of vital interests, be avoided.

The selection of a locality and site demand the greatest care. Free and unobstructed access to a good supply of the best class of operatives is one of the primary elements of success, as without it the production from the plant will be less than it ought to be, and consequently will be burdened with a heavier proportion of the fixed expenses of the establishment than will be that which comes from

competing mills obtaining a higher average production. In the second place, the quality of the production will be inferior, and will therefore sell for less money; this will lay the foundation of an inferior trading reputation which it will be difficult at any time, and under any circumstances, afterwards to shake off. A good trade name should in all cases be sought, as it is always a source of profit; in good times yielding its owner better prices for his wares, and in slack times obtaining for him a preference of such orders as may be in the market.

Once upon a time in the history of the trade mills for both spinning and weaving were planted in isolated villages at considerable distances from the larger centres of population, and to and from which supplies of materials and productions had to be carted at considerable expense. Compensation was obtained for this in the low rate of ground rents and wages; especially, and principally, the latter. At that time employers paid any price for labour which seemed to please them in the then circumstances of the trade. But since 1850 there has been a steady increase in the demand for labour, and a rapid development in its organization which quite precludes the possibility of the existence of such irregularities to-day as were then common. The Blackburn Standard List of Wages, for the manufacturing division of the trade, first established in 1853, has, with modifications, been extended to almost every one of the manufacturing districts, and recently by agreement between the employers and employees' representatives has been modified and adopted as a uniform list applicable throughout the largest portion of the trade. Thus deprived of the power of obtaining compensation for admitted disadvantages from a lower wages rate, few country mills have been able to maintain their ground against the competition of those in the towns, and only under very exceptional circumstances could any be successfully established and carried on to-day. Such locations should therefore be avoided, unless on the most careful and rigid

investigation they can be shown to offer permanent compensatory advantages. This result is a national disadvantage, as it strongly tends to congest the population in large towns.

The remarks made in the writer's previous work on "Cotton Spinning," in Chapter III., on the essentials of success may be transferred to this place with only a few verbal alterations, being quite as applicable to manufacturing as to spinning. It is there said: "Competition in the cotton trade is now so severe, both at home and abroad, that anyone newly adventuring therein cannot afford to neglect the slightest matter that may be conducive to success. If possible, the beginner should start with a sufficiency of capital to provide a perfectly new establishment, well found in every respect, and have a balance left large enough to conduct its commercial operations with advantage. Without a level beginning the chances of success are proportionately diminished. The locality must be well chosen, the site of the mill carefully selected, the mill well constructed, the machinery must be of the best for its particular purpose, the management must be skilful, economical, and thoroughly honest. The manager must be perfectly versed in the practical details of his business, and able to manage men as well as machines. The commercial division of the business must be conducted with skill, prudence, foresight, and a fair share of enterprise. Old methods of procedure must not be retained from an excess of conservative sentiment when it is obvious that they have been superseded by improvements; and machinery must not be retained in work, though intrinsically in good condition, when the progress of mechanical invention has virtually rendered it obsolete. Any person not willing to recognize and act upon these truisms had better not invest his means in cotton manufacturing. Technical, scientific, and commercial knowledge, combined with steady industry and prudent enterprise are required to ensure success." Read "weaving establishment" for "mill" in this quota-

tion, and it will be perfectly appropriate. Since the above words were first written, now nine or ten years ago, nothing has happened in the condition of either the spinning or weaving branches of the trade to lessen their applicability, or weaken their importance; on the contrary, everything that has occurred, and the prospective course of events in connection with the trade intensify and increase their force both to the present and probable future of both branches of the trade.

The foregoing reflections dictate that the weaving establishment under consideration should be located within the area wherein the class of goods to which it has to be devoted are usually manufactured; that it should not be isolated in a country village, unless under the exceptional conditions just described; and that it should be within an area where it will not be subject to extra charges for carriage of supplies inward or of production outward. Anything in this shape above that paid by competitors would be a tax upon the profits to which they should not be subjected. Other matters should also weigh in the selection of a site: it should afford facile and quick access to the market, in order that the persons charged with the duty of buying and selling may always be able to get there in the most prompt manner, and with the least loss of time to take advantage of momentary phases of strength or weakness that may pass over it; the former offering advantages in selling, and the latter in buying, which cannot properly be neglected. And care should be taken that there is also easy access to post-offices, telegraphs and telephones, as on many occasions such facilities induce the conclusion of business that in other circumstances might go elsewhere.

In regard to the selection of a site, it may be as well to make another quotation from "Cotton Spinning," the subject of the present remarks being the same with only a slight variation. "Having decided upon the locality the next matter is to select a suitable site, and in this

practical considerations should mainly govern the decision. Cotton has a considerable affinity for moisture, and when provided with its natural requirements in this respect its fibres are more flexible, and yield more readily, without breakage, to the treatment of the processes through which they have to pass in manufacture. This is true in spinning, but is more forcibly so in weaving, because when in the loom it has had added to it the various ingredients used in the sizeing process. The tendency of starch, kaolin, and various chemical salts with which the yarns are too often overloaded, is to build up a rigid wall of these materials around them, and so greatly reduce their flexibility. Though this is the result it is not that which is sought. Therefore it is endeavoured to be obviated by various well-known means. But sizeing under any circumstances in manufacturing is a necessity which is as old as the art itself, being required to protect the tender material from the severe friction to which it is subjected by the action of the reed; but the stiffness thus induced must be moderated as much as possible. The native Hindoo weaver carries his loom into the open air under the shade of a tree, and digs a trench over which he extends his rice-sized warp, the natural drainage into the trench, and the evaporation from which improves the weaving of the warp. The old English hand-loom weaver in the cotton trade, in order to get the advantage of a bare earth floor, preferred to place his loom on a ground floor or in a cellar to an upper room, and often dug a hole beneath his treddles, into which he poured water. The evaporation from this kept his warp in the best condition for weaving. In this procedure he unconsciously imitated his Eastern competitor with his trench in the earth. The same necessity is incumbent upon his successor the modern cotton manufacturer who desires to get the best results. If wise he will, in this country, plant his shed in a valley protected from dry winds, and open to moist ones; that is, to be more explicit, and having particular application

to the English manufacturing districts, it should be sheltered on the east and north, and open to the west and south. The subsoil should be a stiff impervious clay, affording a solid foundation for structure, and in the vicinity retaining the rainfall as it were in a subterranean reservoir, evaporation from which, in the driest seasons, will moisten and soften the atmosphere around. Should it be necessary to store a water supply, the lodge to contain it should always be placed on the side from which the dry winds blow, mostly the east. This will help to temper the dry atmosphere to the advantage of the work in process. An abundant and never-failing supply of water is an essential requisite, and if this is not present in a stream, river, or canal, provision will have to be made for storing the necessary quantity in a reservoir; and if the supply from the latter is used for condensing purposes, arrangements will have to be made to keep its temperature low enough for such a purpose.

“Good roads giving easy access for cartage purposes, and to and from the residences of the operatives are important. The site should be within such a distance of the homes of the latter as will permit all employed to go to meals and return within the time legally provided for that purpose. Of course, there will always be some exceptions in which operatives will come from too great a distance to permit of this. Provision has then to be made for allowing food to be taken upon some part of the premises not amenable to the visits of the factory inspector, or where the law would be liable to be violated, entailing responsibility upon the owner. This state of matters always causes some extra supervision, and consequently entails cost and risk. A short walk in the open air, such as is had by going home to food is always invigorating and promotive of health amongst the operatives, and ought in all cases, where practicable, to be encouraged. It refreshes them and breaks the monotony of their labour, to which they afterwards return with renewed strength.” These

remarks are transferred from "Cotton Spinning," being equally pertinent here.

As in the spinning mill the fittest material for the edifice will be decided by the circumstances of the locality. If stone lies in close proximity, and can be easily quarried, it constitutes an excellent, durable, and cheap material. When this is not the case, and the site selected contains clay from which bricks can be made, these will generally be found the most economical and suitable material. Should it be necessary to provide a reservoir for water, any clay excavated for this purpose, and also that from the foundation trenches, will be available for this use.

The section or special branch of the business of manufacturing to be followed is usually decided upon in advance of the erection and furnishing of the buildings, this being necessary to permit of the purchase of the most suitable plant for the purpose, and its construction by the machinist, that it may be ready for delivery when the establishment is ready to receive it.

In cotton manufacturing, experience has long ago demonstrated that the weaving process at least should always be conducted upon the ground floor, and never in rooms, however apparently firmly built. The vibration in the latter is always injurious, and in some cases is so to such an extent that to neutralize its effects would require the purchase of yarns a farthing per pound better in quality to produce cloth equal in quantity and quality to that which could be obtained from the use of materials a farthing per pound less on a ground floor. In the weaving process the warp yarns are subjected to considerable strain and friction, which is a severe test of their strength and quality. The vibration of the floor upon which the looms are placed when in rooms above the ground greatly increases the unavoidable strain of the shedding of the warp, and causes numerous breakages that impede and diminish production, and deteriorate the quality of the work. In these times of severe competition and low profits, under ordinary

circumstances no such disadvantage as manufacturing in rooms could safely be faced with any rational expectation of avoiding failure and bankruptcy.

Having been guided in the selection of a site by the considerations thus set forth, the plan of the building should provide that the bays of the roof of the weaving-shed should run in a direction from east to west in order to present the glazed portion of the bay to the north, the volume of light obtained from this point of the compass being the greatest, most steady, uniform in quality, and the best adapted for manufacturing purposes. This point secured, regard must be had to the arrangement of the looms which ought to run in aisles at right angles to the bays of the roof, in order that the slays or lathes of the looms shall not cast shadows upon the warp shed in the process of weaving, and thereby interfere with the weaver's quick perception of yarn breakages or flaws of other descriptions.

The plan, fig. 182, represents a well-arranged weaving shed to contain 510 plain looms, 40-inch reed space, with the necessary preparation machinery of the following proportions:—There are three winding machines placed side by side, with ample space between them for the operatives. Each machine contains 300 spindles and is arranged to wind from mule cops upon warper's bobbins; gauge of spindles $4\frac{1}{2}$ inches. The driving pulleys are 12 inches \times $2\frac{1}{2}$ inches and make 140 revolutions per minute, and with a 7-inch tin cylinder cause the spindles to run at 650 revolutions. The total length of frame is 30 feet $7\frac{1}{2}$ inches \times 5 feet 6 inches wide. Each machine is driven over swing pulleys. In the same room as the winding machines there are six self-stopping beaming machines, having V creels, each to contain 504 bobbins. The machines are placed so as to deliver their full beams into one main passage and have each plenty of space allowed round the creels for bobbins, etc. The floor space of each machine, including creel, is 13 feet 9 inches \times 7 feet 3 inches, with

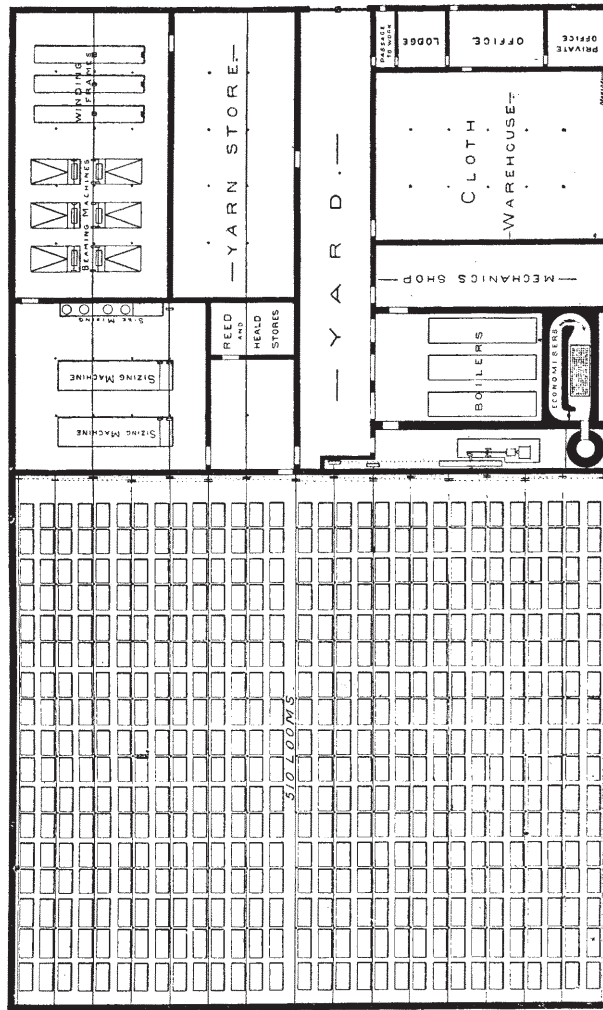

FIG. 182.—PLAN OF WEAVING MILL.

driving pulleys 15 inches diameter running 40 revolutions per minute. All the machines are driven from one main shaft.

The sizing room is situated next to the winding room and provides ample accommodation for two sizing machines and the usual size-mixing apparatus. The former are each nine-eighths wide and are arranged with 6 feet and 4 feet drying cylinders, with creels to hold six warper's beams, length of machine 32 feet 6 inches \times 8 feet 6 inches wide. The pulleys are 13 inches diameter, running 200 revolutions per minute. These machines, as well as the size-mixing apparatus, are conveniently driven. Next to the sizing room there are two spacious rooms for reel and heald stores, and for looming or drawing and twisting-in purposes. These latter are in direct communication with the weaving shed.

All the machinery is driven by ropes in the most direct manner possible, the engine being arranged to drive direct to two first motion shafts, from whence power is transmitted to each succeeding driving shaft by counter ropes and pulleys. From the main shaft, and connected with it by bevelled gearing, a line of light shafting runs parallel with and between each two rows of looms as set back to back, and which are driven from it. The driving pulleys for each loom are placed as direct as possible under each driving shaft. Two of the loom driving shafts are extended into the sizing and winding rooms for driving the machinery contained therein, in the manner above stated.

The question has recently been raised whether by the system of rope-driving more power is not absorbed and lost in its transmission from the engine to the machinery than by wheel-gearing, which since rope-driving practically displaced it, has been considerably improved. Possibly the serious disadvantages of the latter system as they existed up to 1875 may have been reduced, or even obviated altogether in many important respects; but some of them, such as the cost of greasing, the filth incident to

this, the noise, and the liability to disastrous breakages, are essential to the system, and though they may be minimized, they cannot be removed altogether. It is charged against the rope-driving system that too much power is absorbed in dragging the ropes out of the grooves, and the increased friction caused by the weight of the ropes pulling the shafts heavily against their bearings. It is probable that the latter will be a matter that cannot easily, if at all, be removed, or even materially reduced, but the former by improvements in the form of the groove may be obviated altogether. It may, at all events, be assumed that the system of rope-driving did not jump into existence in its most perfect form, and that therefore if it has lost the leading position—which is not admitted—there is no reason why it should not easily regain it. But these and many others are points that will always require the careful personal examination of every person intending to commence business, for until progress ceases to take place, all competitive systems in every department are liable to undergo important modifications.

In the conduct of a large business, such as is implied by a mill like the one described, it sometimes happens that orders for what are termed lightly picked goods will be received, in working which the looms would overrun the preparatory department, if permitted, which would cause inconvenience, loss of time, and diminished production. In order to avoid this result a small engine is provided for overtime working of the preparatory department—especially the sizing machines, without running the shafting and gearing of the other portion of the establishment. The steam left in the boilers, and which would otherwise condense during the night, is generally sufficient for this purpose, and is thus utilized. A mechanic's shop for making repairs completes the equipment of the establishment.

The boilers, along with the economizers and chimney, are in close proximity to the engines, and are arranged as com-

pactly as possible, whilst a large mechanic's shop is conveniently situated alongside. The coal space for the boilers is easy of access from the yard.

A spacious yarn store and cloth warehouse are provided, and have each direct communication with the yard for loading and unloading purposes.

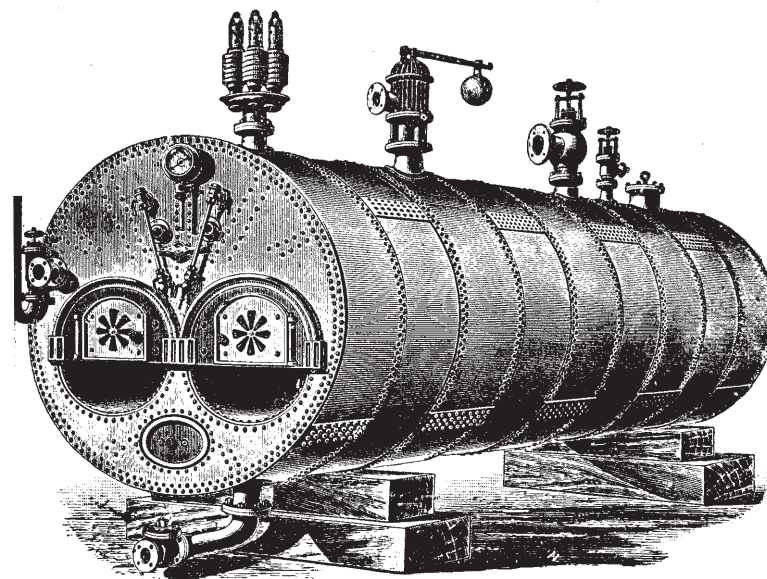

FIG. 183.—THE LANCASHIRE BOILER.

The arrangement of the shed generally is suitable for economical working and can be readily extended without very great cost.

We may now turn and look at these matters in a little more detail. The selection of a proper type of boiler is an important matter. Cotton manufacturing is in no sense a business that furnishes fuel as a waste or bye product

of any of its processes. All the fuel has to be purchased in one way or another. Therefore the type of boiler should be that constructed to give the highest degree of evaporative power from every pound of fuel consumed. There are many types of boilers, but the merits of these need not be discussed in the limited space that can be devoted to the matter here. It is enough to appeal to the general experience of the trade, and this has long declared the Lancashire boiler (fig. 183) is simple, efficient, and economical, whilst it can be easily cleaned and kept in order. This boiler, as will be seen from the illustrations given herewith, of the front view (fig. 184), and cross section, 185, contains two flues, extending the entire length. Each tube has its own furnace. The presence of two flues distinguishes the Lancashire from the Cornish boiler, which contains only one. The two flues give much greater heating surface than one, and thus more effectively utilize the heat generated. With a view to still further increase the steam generative power, the flues are fitted with what are termed Galloway tubes, shown in the cross section (fig. 185). These have long ago been proved of such advantage, that they are now found in almost every boiler of the Lancashire type, by whoever made, as the patent right has expired. In addition to economizing the heat developed, these tubes facilitate the circulation of the water in the boiler. The boilers are of course fitted with the usual steam and water gauges, pressure indicators, blow-off taps, and the other appliances conducive to efficiency and economy. The internal construction of this boiler is shown in fig. 186, a longitudinal section.

Notwithstanding every device indicated in the construction of the boilers illustrated here, and of other types also, there is still an enormous waste of the heat generated, which passes into the atmosphere unutilized, and the fuel consumed to produce which is thus wasted. The steam boiler has hardly ever had that attention given

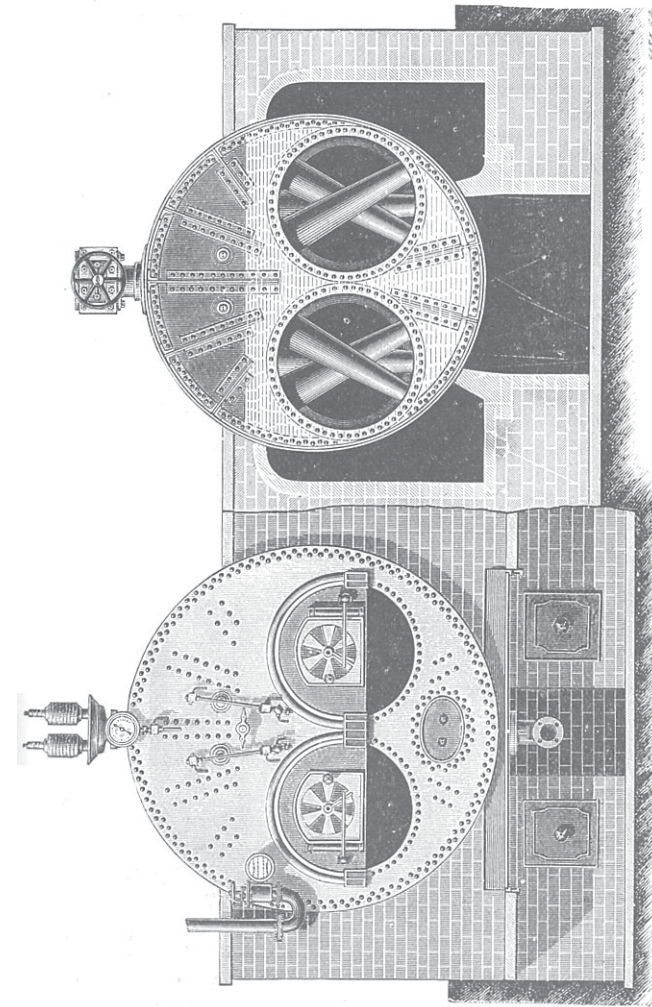

FIG. 184.—FRONT VIEW.
FIG. 185.—CROSS SECTION.
A PAIR OF LANCASHIRE BOILERS, SEATED.

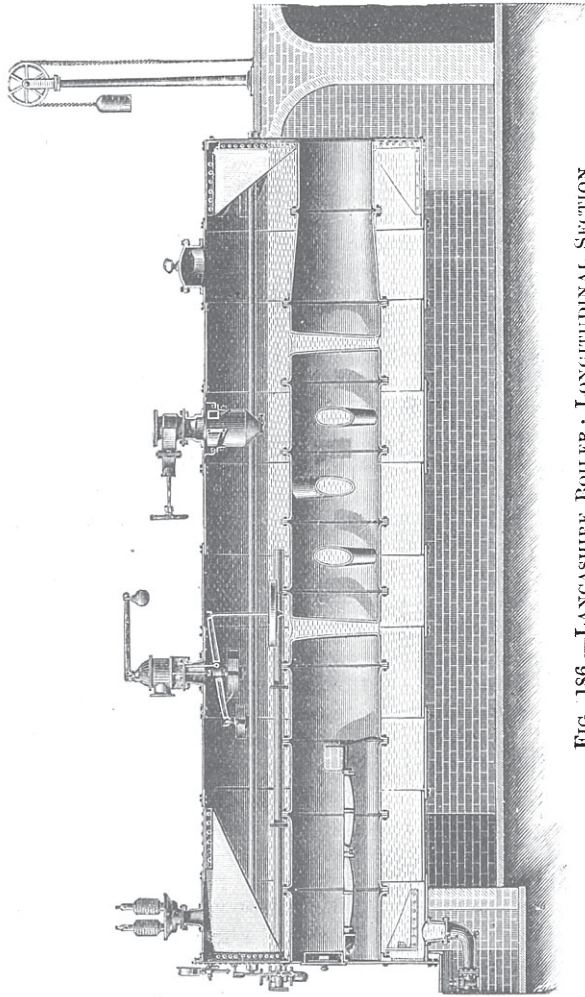

FIG. 186.—LANCASHIRE BOILER; LONGITUDINAL SECTION.

to it which its importance deserves, and which in the way of economy it will well reward. This neglect, however, seems likely soon to be remedied, as its turn for attention is beginning to be recognized. It has been seen that the wasted heat ought to be utilized, and attention is being closely directed to the accomplishment of this end. One method of doing this is illustrated in fig. 187, which shows an improvement in the construction of the furnace

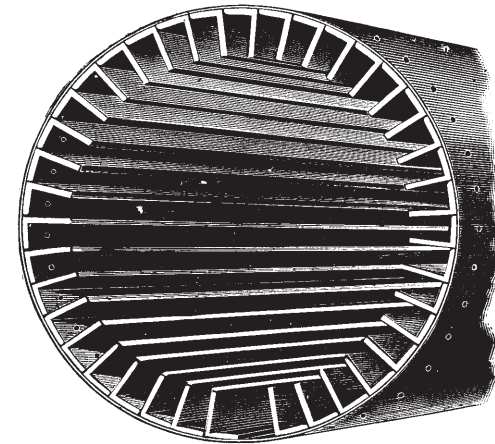

FIG. 187.—IMPROVED BOILER FLUE.

flue. The inventor recognizes that the air and gases developed in the boiler furnaces are heated to a temperature of from 1,700 to 2,000° F. This of course would fuse the entire furnace and its surroundings, were it not conducted to the water contained in the boiler, or allowed to escape into the air. Its escape into the air is not desirable; its absorption by the water is. It is unnecessary to do more than remark that water vapourizes and passes off in steam at 212° F. This occurs with the water in contact with the external surfaces of the furnace flues,

water of a lower temperature taking its place until it attains the same degree of heat, when it passes away in a similar manner. The whole volume of water the boiler contains thus becomes heated to the same degree, and the circulation goes on, the vapourized water passing into the steam space of the boiler, where it is stored until required by the engine. The point to be observed here is that the heated gases of combustion impinging upon the internal surface of the boiler flues, and whose temperature, as just observed, is from 1,700 to 2,000°, are rapidly reduced from that point to something near 212°, by parting with their heat to the water, the iron of the flue being the medium of conduction. Thus continuously the flue is lined with a thick film of comparatively cool gas throughout its entire length. This gas is a bad conductor of heat, and is almost impenetrable to the greater heat of the unchilled core of hot gases rushing along to make their escape through the chimney, and which thus carry away their valuable quality of heat, produced at so much cost, unutilized.

How rapidly this heat passes away will be seen when it is stated that a Lancashire boiler is generally 30 feet in length, and that the force of the draught or rate of the passage of air through the furnace and flues is about 650 feet per minute, thus giving only about three seconds of time for it to deliver its precious freight of heat to the water. This is totally inadequate for the purpose, even if we quadruple the time, in order to take into account the external flues of the boiler. The inventor, in order to capture the heat of the core of gases thus escaping, has lined the internal surface of the flue with angle bars or plates, which extend through the outer stratum of chilled gases into the hot core, and taking up its heat transmit it to the water in the boiler, iron being one of the best of heat conductors. The result of the experimental tests that have been made has been highly satisfactory, as also have those of a few commercial ones made in an immature stage of the invention.

But whatever may be the ultimate fate of this invention, it is in this direction of the economization of fuel that the manufacturer, and all steam users, should look for the attainment of a considerable advantage.

A new manufacturing establishment should be equipped at the outset with the most improved appliances, not only

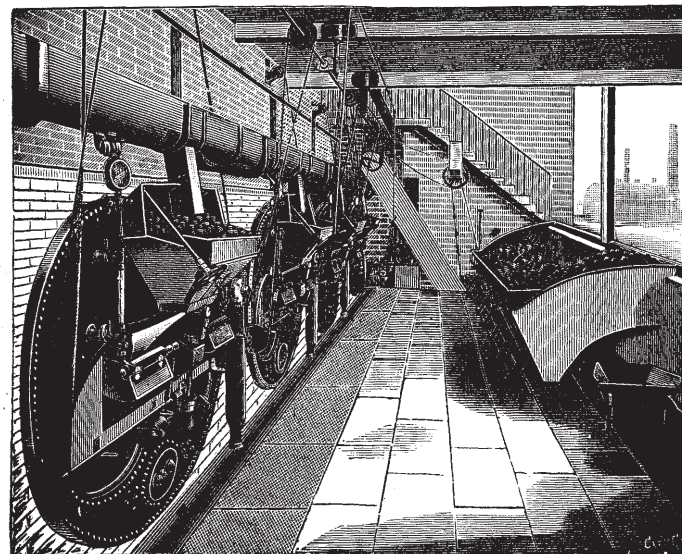

FIG. 188.—BOILERS WITH MECHANICAL STOKERS AND STOKER FEEDERS.

in steam generation, but in the economical use of the labour necessarily employed to produce it. Hence there have been invented as aids to this end quite a number of mechanical stokers of more or less merit. These, however, have not been in the main labour improvements upon the human manual stoker. They greatly lightened the oppressiveness of the stoker's labour in relieving him

from direct exposure to the glare and heat of the furnace, and dispensed with the requirement of skill on his part in the distribution of coal upon the fire. He had only to feed the hoppers of the stokers, and if he could throw the coal into them it could not go wrong. The iron arms of the stoker did the distribution.

Something, however, remained yet to be accomplished. If the furnace could be fed mechanically, why could not the hoppers? The inventor again, in the person of Mr. Thomas Wrigley, the principal manager of the extensive mills of Messrs. Fielden Brothers, Limited, Todmorden, said they could be, and forthwith proceeded to show how, by the invention of his automatic stoker feeder. The

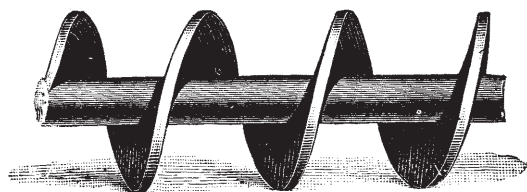

FIG. 189.—MECHANICAL STOKER FEEDER CONVEYOR WORM.

accompanying illustration, fig. 188, represents a series of boilers fitted with mechanical stokers, and the mechanical stoker feeder. Instead of tipping the coal, as usual, into and upon the floor of the "fire-hole" in front of the boilers, a series of large hoppers are arranged in front of them for the reception of the coal, and into these it is tipped from carts or waggons as the case may be. The hoppers have vents at the bottom and discharge into a channel in the floor. In this channel is fitted a large conveyor worm, a short length of which is shown in fig. 189, the revolution of which carries the coal to the end of the fire-hole, delivering it into a small hole, whence it is lifted by an endless chain of buckets forming the elevator. These discharge it into the longitudinal

half-tube extending along the front of the boilers over the hoppers of the mechanical stokers. This contains a second conveyor worm which brings the coal along, delivering it at orifices over each hopper. It will thus be seen that by this arrangement the coal is never handled from the moment it is received right through to its combustion. The invention thus dispenses at least with the services of one man to every three boilers. It also prevents all waste of coals by their getting into the ashes and being carted away before combustion. It thus becomes an important labour-saving appliance, as one or two men can take charge of all the boilers of a large establishment, and have less to do than when they had only charge of two on the old method. The conveyor worm is constructed of cast iron on a principle discovered or invented by Mr. Wrigley, by which a cast-iron worm, true in construction, and of any desired diameter or weight per foot, and of any length desired, and which can be used for a conveyor for either light or heavy substances, can be made. A worm of this kind has been a great desideratum, and Mr. Wrigley, by its invention, has placed the world of mechanics under an obligation.

Another important method of economizing the heat generated in the boiler furnaces is the economizer, as it is called, and an illustration of a set of which is given in fig. 190. These pipes are placed behind the boiler, the feed water for which passes through them. As the hot gases leave the boiler flues they impinge upon these pipes and heat the water contained in them to or over the boiling point, so that it does not lower the temperature of that contained in the boiler when it enters, and does not itself require to be heated up to boiling point by the furnace fires. This valuable adjunct to steam generation introduced by Messrs. Green and Sons, Wakefield, is so well known as not to require any further remarks.

An important part of the furniture of modern steam boilers are the valves. The now common practice of

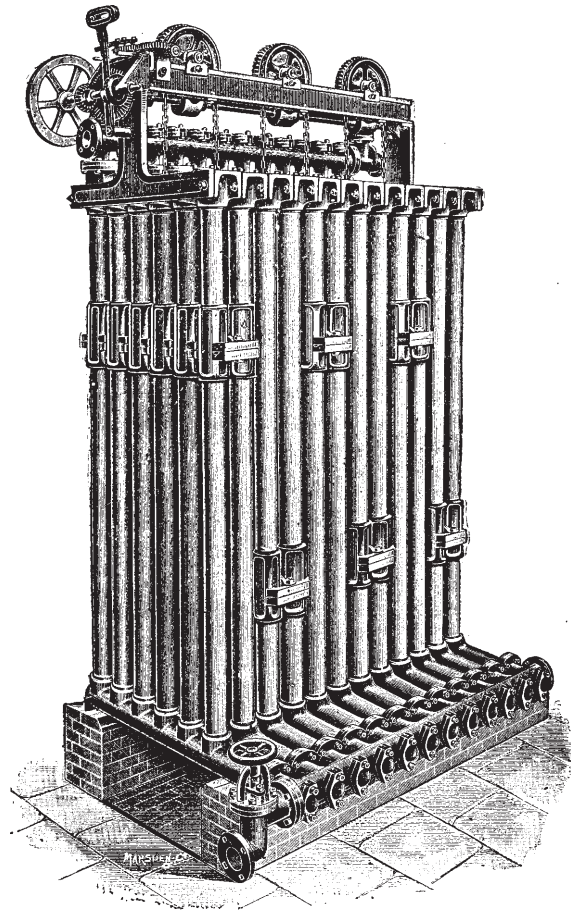

FIG. 190.—GREEN'S ECONOMIZER.

working at very high pressures, and the growing tendency to increase even these has to a great extent rendered obsolete the older types of valves, and their continued use in the changed circumstances not free from risk. To suit present needs the dead weight valve, which has done good service in its day, would need to be constructed in a very cumbersome form, and with a large increase of material. For

a boiler working at about 150lb. pressure it requires over half a ton dead weight for a 3 inch valve. To meet the new requirements an improved valve has been designed (Fowler's patent) and placed upon the market by the makers, Messrs. Meldrum Brothers, Engineers, Manchester. This improvement is termed The Compact Dead-weight Safety-valve, and is illustrated in fig. 191. It consists of a hollow spherical casing resting on two seats, one face of the valve and one face of the seat forming portions of concentric spheres, so that the valve is left free to oscillate slightly on its seat, while its

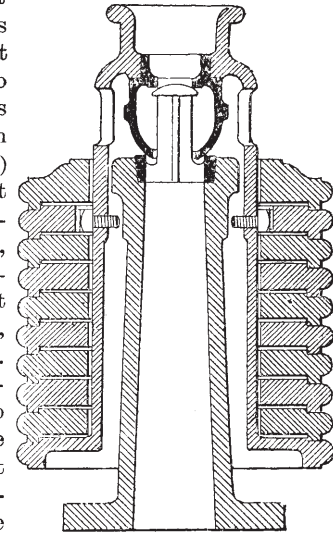

FIG. 191.

construction is such that the dead load required is only necessary to weight the annulus represented by the two valve diameters. This reduces the total weight of the valve by fully one half, whilst the separate pieces can be easily handled, and the valve be fitted by one man. This arrangement secures all the advantages of a dead-weight valve, whilst two outlets being provided, more rapid relief is afforded in the event of pressure rising too high.

Another important safety provision is a combined high-steam and low-water safety valve, by the same inventor, and issuing from the same firm. It has been specially designed to give prompt warning of the running short of the water supply, and to automatically reduce the pressure in the boiler, by allowing the steam to escape at the same

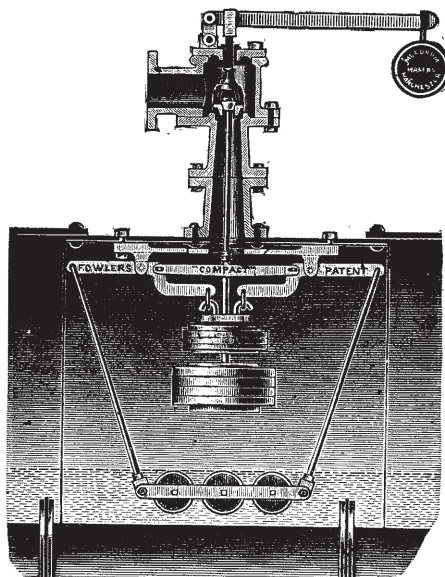

FIG. 192.

time. It consists, as will be seen from the accompanying illustration (fig. 192) of a duplex arrangement of levers, with a balance-weight suspended centrally above the float. The latter is composed of several cylinders suspended from two stirrups. These cylinders are filled with water, and require only a balance equal to their immersed weight. The water contained in them causes the valve to lift when

the surrounding water leaves the float. The construction of the float renders it easy to balance the parts for proper working before the valve is sent away from the makers, after which there is no requirement for readjustment arising from the decay of the parts as in the older types. The introduction of duplex levers renders the valve much more compact than before.

The engine next calls for a few observations. A good type, and one very suitable for a manufacturing establishment such as the one under description, is represented in the accompanying illustration. It is an elevation of a modern horizontal compound-engine, with condenser. It is fitted with grooved fly-wheel for transmitting its power by ropes. The cylinders are fitted with Corliss gear. They are arranged tandem fashion, or one behind the other. On the right of the illustration is shown a powerful barring apparatus, the function of which is to bring the engine into proper position for starting. Such engines as these show a wonderful advance upon those of twenty-five or thirty years ago both in construction and economy of working.

The equipment of a mill or weaving establishment with the gearing and shafting generally goes with the engine contract, though not always. Steel shafting is to be preferred, as it will transmit from 25 to 30 per cent. more power than the same weight of good wrought-iron shafting, and this weight avoided there is a corresponding reduction of the cost of driving. Shafts should be well supported, and carried in wide bearings not too wide apart. Bright shafting is more easily kept clean than dull shafting, and so slightly diminishes fire risks by not allowing the lodgement of cotton down or dust thrown off in the processes of working.

The pulleys should be of the unbreakable or wrought-iron type which are strong, light to drive, and repairable in the event of accidents occurring to them. An illustration is given of one of these in fig. 194. Where pulleys

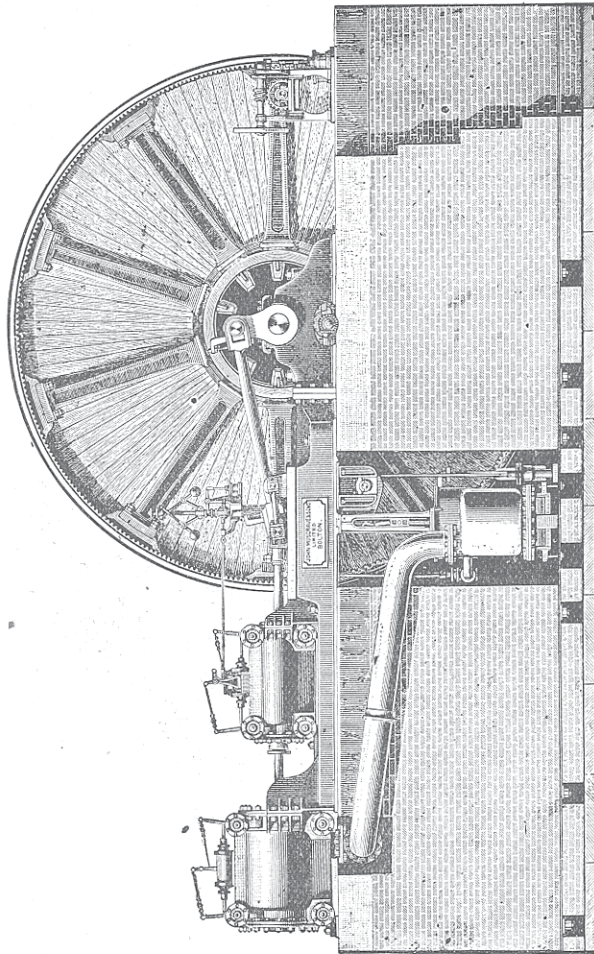

FIG. 193.--HORIZONTAL ENGINE, TO TRANSMIT POWER BY ROPES.

are placed in such a position that there is a probability of their being in the way of some requirement or other they should be of the kind called split pulleys, so that they can be removed and replaced with facility.

Of late years swivelling shaft bearings have come into extensive use and favour. This form of bearing is by far the best and most economical in use at the present time.

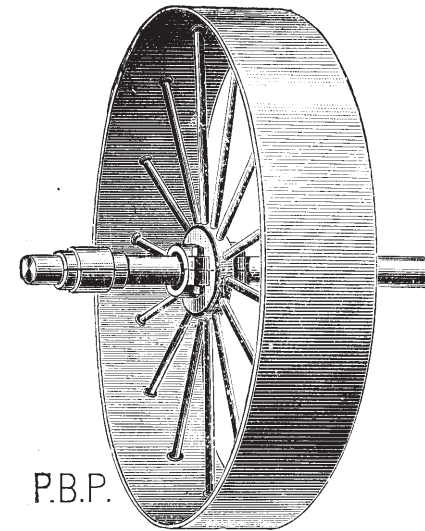

FIG. 194.

It is easily erected and adjusted vertically or horizontally, and afterwards needs little care, as it perfectly adapts itself to the alignment of the shaft it is supporting. Fig. 195 shows a wall bracket with adjustable swivel pedestal; fig. 196 exhibits a flat pillar bracket with adjustable pedestal; fig. 197 depicts a swivel adjustable pillar bearing to clip on round pillars; and fig. 198 shows a wall box with adjustable pedestal. The illustrations

represent the types of these bearings as made by the Unbreakable Pulley Company, West Gorton, Manchester. Adjustable bearings ought to be used wherever economy of driving is a consideration. Unless the equipment of the establishment in shafting and gearing be well done a loss of power and a waste of lubricants takes place, whilst

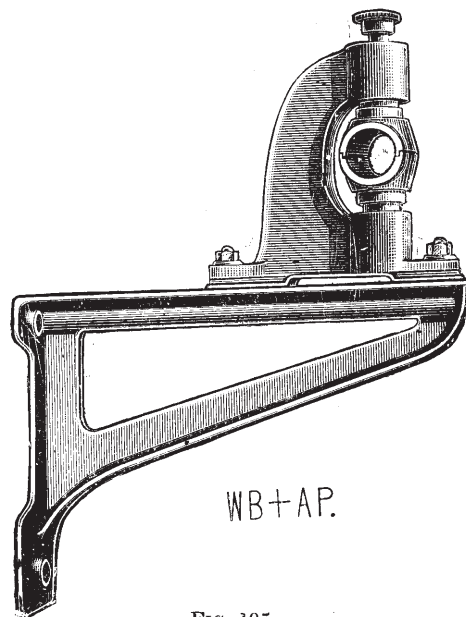

FIG. 195.

the liability to breakdowns, with the trouble and expense incident to them, is greatly increased.

Power is transmitted from the prime mover chiefly by three methods: wheel-gearing, belts, and ropes. From the early part of the century until well on in the sixth decade gearing was almost solely employed. It had, however, many serious defects, including great liability

to breakdown. About 1868 the attention of engineers in this country was attracted to the fact that in America it had become common to transmit power from the engine

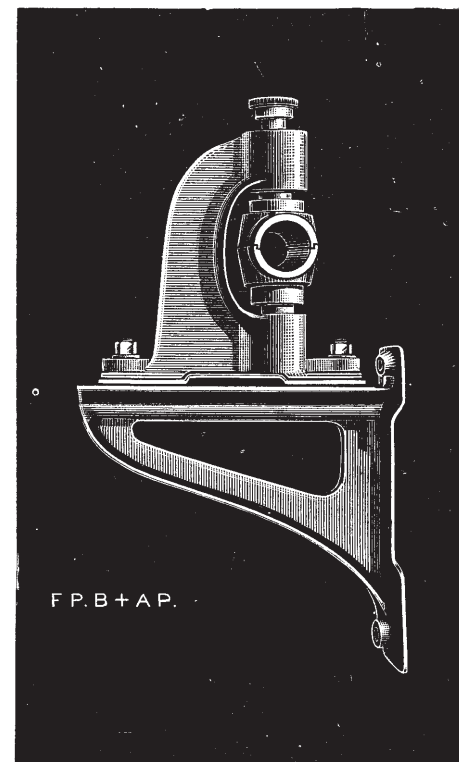

FIG. 196.

to the first driving-shaft by means of a large leather belt, and thence by other belts to successive shafts until the machinery was reached. This began to be regarded with considerable favour in the English manufacturing districts,

and was adopted in a number of instances. In the autumn of 1875 a Bolton gentleman, Mr. William Bamber, a cotton

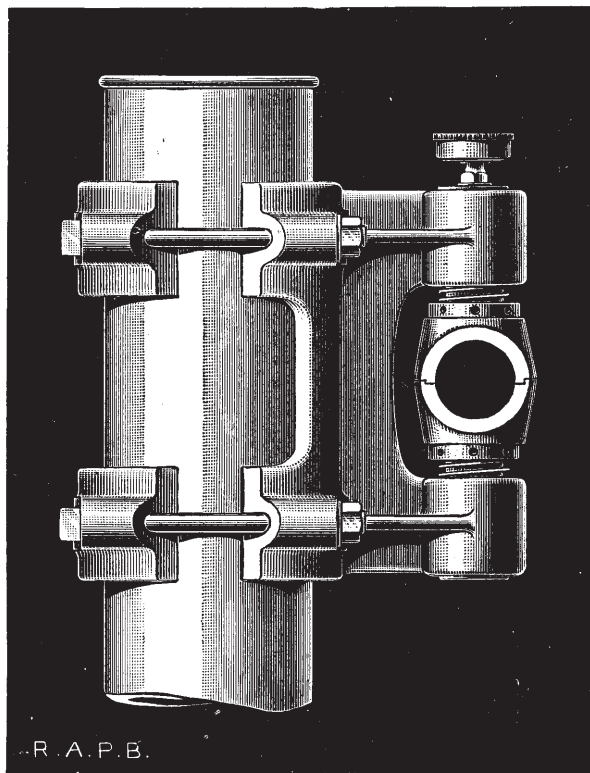

FIG. 197.

spinner, was spending a brief holiday in the neighbourhood of Dundee, in Scotland, when happening to enter a small flax or jute mill in the country, his attention was arrested by the fact that the power was being transmitted from the

engine to the first shaft by means of ropes running in grooved pulleys, which had taken the place of the usual spur gearing. As a practical man, the full importance of the advantages of the system struck him at once. His mill in Bolton having just previously been destroyed by

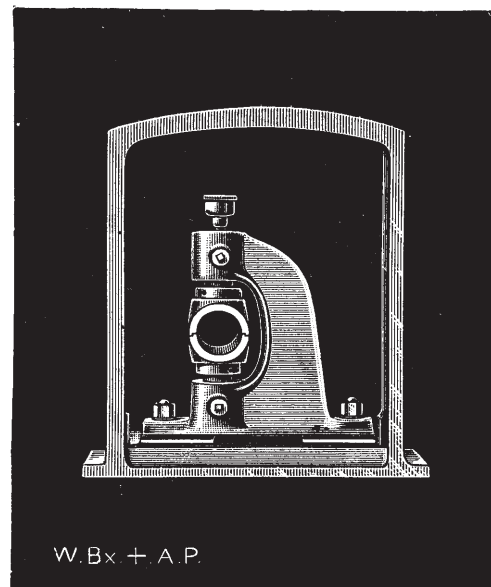

FIG. 198.

fire, and being then in course of re-erection, he instantly decided upon adopting the new method. Communicating with his engineers, Messrs. John Musgrave and Sons, Bolton, he explained his desires, and they after some hesitation as to the wisdom of the new departure, carried his views into effect. The result was highly satisfactory. Soon after its completion the present writer was invited

to inspect the new system, and was so pleased with it that he made a careful examination, and gave publicity to it in a journal with which he was then connected. The new system attracted wide attention, and excited a considerable amount of interested opposition. Its merits, however, were so evident, that this was soon silenced, as spinners and manufacturers would have nothing else. It has since been adopted in almost every new mill that has been erected. In a few cases the two systems of spur gearing and ropes have been combined. On the whole the introduction of the system has been an improvement of inestimable value. The writer has since learned that it owed its revival—for it is really an old system—to a Belfast firm of machine makers, who patented it, but did not push its adoption probably through becoming aware that the patent was invalid from previous use.

Hemp and manilla ropes were at first employed, but cotton was soon tried, and found to possess better wearing qualities than any other material. The result was that cotton soon became of general use in the manufacture of driving ropes.

The transmission of power by ropes is a use which calls for a modification of the usual method of construction, as several new factors affecting the value of the rope and its durability enter into the problem. An ordinary rope is made to bear a heavy strain mainly arising from a direct pull. The rope used in the transmission of power has this to do and something more, namely, to submit to constantly recurring flexure and straightening again as it bends over the pulleys and is straightened out again in its passage from one to the other. This begets an enormous amount of friction amongst the fibres of which it is composed, which has a tendency to pulverize them. Those fibres lying on and forming its surface have also to bear the frictional contact with the grooves of the pulley, of entering them and being dragged out. These form great additions to the burden of an ordinary rope. The superior

flexibility of a cotton rope undoubtedly is the cause of the preference shown for it for this purpose, but even the cotton rope in its best ordinary form left much to be desired in the way of increase in the qualities of flexibility and durability, and inelasticity.

Seeing these facts, Mr. Thomas Hart, of Blackburn, the present head of a very old established firm of rope-makers, set himself to solve the new problem. This he accomplished by the invention of the well-known "Lambeth Rope," so named from the Blackburn works of Mr. Hart. This is a cotton rope of peculiar construction. It is composed of four strands, each strand consisting of a number of cotton yarns run out parallel to one another at a uniform tension, so as to give equality of length to each. These threads form the core of the strand, and one intended to bear the whole of the tensile strain that it has to carry. The strand is not twisted, or at least not more so than to bring the yarns together. The absence of the usual twist leaves the strand exceedingly flexible. Around this untwisted strand of yarn an envelope is thrown composed of ten twisted cords of cotton yarn, which are wound helically around the strand, enclosing it in such a manner as to form for it a perfect shield, which preserves it from wear and maintains its flexibility.

Four of these are combined in one rope. The central cavity that would be left when four cylindrical strands were twisted together is filled by three cords. It will be obvious from this description, and the illustration (fig. 199), that the cores of the strands will receive all the tensile strain, whilst the envelope or shield will bear all the wear and tear of the frictional contact of the rope with the grooves of the pulley. The core threads are arranged in the best possible manner for developing a far higher degree of tensile strength than has ever been attained before, and with the least injury to the component material. The envelope, being relieved of all strain, much more

effectually resists frictional wear. The combination of strand and cover gives the maximum of durability, strength, and flexibility yet attained in ropes for this purpose.

This construction is extremely well suited for transmitting power. As it hardly stretches at all in work after being put on the pulley, its great flexibility enables it to bend easily to its work in passing round the periphery of the pulley, and to straighten out again when coming from it. Ropes constructed on the ordinary method tend to pulverize and soon break from this cause,

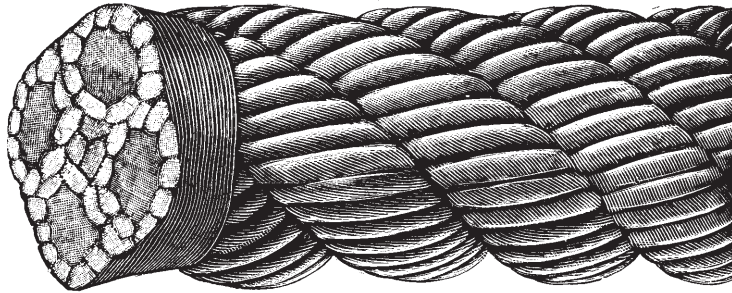

FIG. 199.—THE LAMBETH DRIVING ROPE.

owing to the bending backward and forward destroying the cohesion of the particles of the fibrous material of which they are composed. In some recent tests it required a weight of 13,260 lb. to break a rope of $1\frac{1}{2}$ in. diameter. With a strain of 1,775 lb. the same rope stretched only 2.80 per cent. The general working load of such a rope is much less than this. The durability of ropes are of course considerably affected by the conditions and circumstances in which they work. There are instances of this rope having been in constant use over ten years, and which still appear to be as good as when first installed.

CHAPTER XII.

MISCELLANEOUS MATTERS IN THE EQUIPMENT AND ORGANIZATION OF A COTTON MANUFACTURING ESTABLISHMENT.

An East Lancashire cotton manufacturing establishment selected as typical of the trade.—Classification of cotton goods.—A selection for one mill necessary.—A mill for the production of goods for Eastern markets described.—Blackburn the centre of this industry.—The construction of the mill and the concurrent provision of engines and machinery necessary.—Mill stores.—The selection of proper qualities of yarns and production of sample cloths of primary importance.—Reception of yarns and subsequent passages through processes indicated.—THE YARN STORE: described.—THE PURCHASE OF YARNS: the qualities to be looked for.—GENERAL QUALITIES OF YARN: the necessity of selecting proper standards and preserving samples.—TESTING OF YARNS: permissible amount of variation of counts; coarse or fine counts and moisture.—A STANDARD COTTON AND YARN TESTER: crude methods of testing unreliable and unsatisfactory.—A scientific standard of dryness from the International Congress of Turin.—A scientific yarn tester for damp yarns, *illustrated*.—Percentages of loss on 1 lb. of yarn.—Points to be taken into consideration.—TESTING COUNTS: should be carefully performed; its great importance.—YARN TESTING AND INSPECTING MACHINES, *illustrated* and described.—How to use them.—Preservation of samples.—How to ascertain the amount of twist by it.—Test for elasticity, *illustrated*.—The ordinary method of testing defective.—A twist tester, *illustrated*.—Testing by calculation the best method of getting uniform weights of cloth.—TESTING YARNS FOR STRENGTH: testing by hand, and its advantages in showing the presence of other faults.—Thick and thin places, “neps,” “crackers,” their origin, etc.—The lea strength tester, *illustrated*.—The only satisfactory and perfectly reliable test is derived from the careful examination of a yarn in practical work.

IN this essay the writer will follow the plan adopted in his preceding one, the emphatic approval of which he is pleased to acknowledge, and devote the following pages to an exposition of the means whereby, in his opinion, from the materials employed, the highest quality and the greatest amount of production may be obtained at the

smallest cost. Again, as in the spinning division, there will be found no antagonism in the methods: that which conduces to one result being equally favourable to the other.

It may be assumed that the reader who has carefully perused the preceding chapters will have gathered a sufficient knowledge of the machinery required to equip a cotton manufacturing establishment in almost any branch of the trade. The description given, however, so far as it has any specialty, applies in the main to the great weaving district of East Lancashire. Assuming that one of the branches of the trade carried on therein has been selected, we may proceed to describe its equipment and general organization.

The manufacturing branch of the trade is more subdivided than the spinning branch, and its productions do not lend themselves to the plan of grouping in classes so easily as yarns. They will, however, admit of being roughly divided into five or six great groups, which again will each require to be subdivided into several smaller ones. These are:

- 1st. Domestics, mediums, and long cloths.
- 2nd. Printing and finishing cloths.
- 3rd. Shipping goods for Eastern markets: shirtings, jaconets, mulls, and bordered cloths.
- 4th. Coloured goods: a large variety for home and shipping.
- 5th. "Fancy" goods, so called from being made in complex weaves, and with the aid of elaborate shedding and picking mechanism.
- 6th. Fustians: these consisting of moleskins, cords, velvets, velveteens, &c.

It is not necessary at this point to enter into or even enumerate the subdivisions; they will be more properly noticed, if necessary, later on. The adoption of any one of the above divisions will govern the decisions of the intending manufacturer in the selection of locality in which to

carry on his operations, and the structure of mill and machinery for producing the same. It will at the same time compel and confine the commercial part of the business into special and appropriate grooves.

Within the prescribed limits of this work it would be clearly impossible to treat each division in elaborate detail. A selection, therefore, becomes necessary. The third division will afford the best choice, not only on account of its being the most important and varied in its productions, but because it will more readily admit of digressions in either direction to notice the specialities of machinery, processes, and productions, as they may from any cause require attention.

The great district of which Blackburn is the centre, is the chief seat of the industry represented in the third division, and its selection demands that our ideal establishment should be placed within its pale. The exact locality should be one in which an abundant supply of trained and experienced hands are available, and no local physical obstacle should impede access thereto. Supply and demand in relation to labour should operate as freely as possible. Other things being equal, the choice of the labour market should be as open to the owner as to any of his competitors. If any of these points are sacrificed care should be taken that full compensating advantages are secured in permanence.

The weaving-shed and the details of its structure have been sufficiently described in the preceding chapter.

Parallel with the construction of the weaving-shed, or at least immediately antecedent to its completion, it will be necessary to consider the commercial side of the business, because the arrangements required ought to be as far as possible perfected before they are needed to be set in motion.

It is assumed that the engineering work necessary to fully and properly equip the weaving establishment with boilers, engines, shafting, gearing and other essentials,

have been duly contracted for, and such conditions made as to preclude delay in its execution. If this has not been done, loss may occur owing to the capital previously expended being rendered unproductive for a longer period than ought to have been the case. The same remarks will apply to the machinists who are to supply the preparation machinery and the looms. Indeed, delay at any point from any cause, will necessarily paralyze work at every point and involve loss. Assuming that these points have been attended to on the lines laid down, little will remain to describe of its mechanical equipment but what will come before the reader in an incidental way.

The next requirement will be the provision of the mill stores necessary to equip and set the preparatory machinery and the looms to work. These will consist of healds, reeds, pickers, picking bands, strapping for driving-belts and other purposes, brushes, oil, sizing materials, etc.

The next step is one of primary importance, namely, the selection of the proper qualities and purchase of yarns. This must be governed by the character of the business intended to be pursued. It has already been assumed that the branch selected is the Blackburn trade, the manufacture of goods mainly intended for exportation to the great markets of Eastern Asia: India, China, Japan and subjacent countries. These consist of T-cloths, sheetings, shirtings, jaconets, mulls, and cotton cambrics. But this would be far too extensive a field to endeavour to cover, as each of the three first classes of articles require to be divided again into three sub-classes, namely, low, medium, and good qualities; whilst in shirtings, jaconets and mulls, there are sub-varieties, namely, shirtings, jaconets and mull dhooties: that is, shirtings, jaconets, and mulls having taped, plain-coloured, or coloured striped or figured borders. Then again, besides these varieties there are the same in narrow, medium, and wide makes, and in these only the qualities for which proper provision has been made in the widths of the looms, can be undertaken.

These various cloths require different counts of yarns, and in their subdivisions different qualities of the same counts. In the latter it is highly inconvenient to work them together on account of the risk that exists of the different qualities of the material getting mixed. This has led to manufacturers adopting one or other of the ordinary subdivisions, and to make accordingly, good, medium, or low qualities, as the case may be. The section having been decided upon will dictate the counts and quality of the yarns to be purchased. As a rule persons beginning manufacturing will have to undertake the responsibility of these decisions with but little guidance from actual contact with the market, because no merchant would give them an order without first seeing samples of their production, and samples cannot be produced without manufacturing being actually commenced. To any application for orders under such circumstances the merchant would reply, "Show me samples of what you can make." And very properly so. But in commencing business it is more usual to engage the services of an agent of experience and reputation, and having a good connexion, such a one being able to offer valuable advice at the beginning.

Assuming that these matters have been decided, and that the supply of yarns has been bought, it is brought into the establishment in large skips or baskets, holding from 250 to 300 lb., and is warehoused in the yarn store. From here it is delivered to the winders; next, upon bobbins, to the warpers, and thence upon beams to the sizers. After its passage through the latter process, it is delivered upon loom-beams to the drawing-in or looming-room, for the drawers or twistors to attach the healds and complete its preparation for the loom. From here it passes to the weaving-shed, in which, so far as the manufacture is concerned, it is completed. It is only in rare instances in this country that bleaching, dyeing, or printing is carried on in the same establishment. Weft yarns, as a rule, not requiring any preparatory treatment, pass

directly from the spinner to the weaver, and when received are simply warehoused in the weft-store, whence they are delivered in small cans or baskets to the weavers in the loom-shed. When the cloth is woven it is cut into certain marked lengths called pieces, and sometimes collected from the weavers by a labourer, carried into the warehouse, and entered to the respective weaver's credit. In other cases the weavers deliver the cloth to the warehouse. After careful examination, it is made into bundles, and despatched to the agent or merchant in Manchester. With this prelude we may now speak of a few preliminary matters before proceeding to treat of the conduct of the various processes which will require a chapter to themselves.

THE YARN STORE.—Assuming that a weaving mill has been constructed, approximately, at least, on the lines laid down in a previous chapter, we may offer a few remarks on the yarn store. This should be a cool apartment on the ground floor, or a cellar with plenty of light, though not admitting the rays of the sun in a direct manner to any considerable extent. In the matter of dryness it should be a little below what may be called "par." Let it be assumed that 100 represents natural dryness; 0 = zero, a humid state of the atmosphere that would imply rain; the condition of a yarn store would be best at about 60-70. There is something in slight humidity and coldness that tends to produce consolidation in cotton yarns, and to make them work better both in the winding-room and the weaving-shed. Neither twist nor weft that have been exposed for several days to the high temperature of the winding-room or the weaving-shed work nearly as well as that which has been newly supplied from the yarn store.

THE PURCHASE OF YARNS.—It is always best to purchase yarns that are of a reliable character, both in the points of quality of material and regularity of counts, because those which vary in either of these respects will at one time or other involve the user in loss and trouble; in the latter

when the counts run down, and in the former when the variation renders it unfit for the purpose intended. It is a good plan to find several spinnings that are satisfactory, and as nearly alike as possible, and to work these as exclusively as circumstances will permit, because by changing from one mark, or spinning to another without due care, all sorts of irregularities are induced, the bad consequences of which the best management cannot obviate. The cloth produced will thus get a bad character, and though actually fluctuating in quality, will always have to be sold at a degraded price. There is another reason why several spinnings should be discovered about equal in quality: it is not desirable that a weaving establishment purchasing its yarns should depend upon one or two spinnings which circumstances, such as forward engagements to other customers, a strike, a breakdown, or a fire, might cause to be taken from the market at any moment.

GENERAL QUALITIES OF YARNS.—It is very important that a proper standard of quality should be selected for the yarn it is intended to use, and that samples of this should be preserved and kept perfectly clean. Subsequent purchases should be regularly compared with these samples and not with each other in succession. In the latter way considerable degradation is liable to occur, owing to the shades of difference, though in each separate case the change may be imperceptible, becoming in the aggregate very great. The qualities that should be looked for are the proper shade of colour, cleanliness, evenness, strength, and a uniform amount of twist. When in these respects the different lots prove equal to the standard sample, and have been found correct in counts, and gross, tare, and net weights, and tested for "damp," they may be passed for use.

TESTING OF YARNS.—One of the most important matters in connection with a manufacturing establishment is the careful testing of the yarns that are purchased for its use. The first point to be regarded is the counts, which ought

to be full to the number purchased, and should neither go under nor over more than half a hank. In medium counts there is no valid excuse to be offered for a wider variation. Some years ago it was a common practice amongst spinners, say of 32's, to assume that they had perfectly complied with the terms of their contract if they delivered 31's, and they would have been prepared to affirm that there was but little ground of complaint when 30's were delivered: a deficiency of over 6 per cent. in length from the nominal point. This in the halcyon days of big profits was a matter that could be ignored by manufacturers: but of late, say during the past fifteen years, owing to the severity of competition at home and abroad, this cannot be done any longer by those who have the slightest regard for the maintenance of their solvency, let alone making a living out of their investment and labour. The exactitude of manufacturers in this respect has brought about a change in the habits of spinners, but which it is regretful to say has only substituted one evil for another. The method now adopted is to spin yarn two or three hanks above the nominal counts and by placing it in circumstances favourable for the absorption of moisture, say in shallow wicker baskets, in a damp, steamed, or well-watered cellar, to bring it down to proper counts by the absorption of moisture. The water thus surreptitiously added is invoiced to the manufacturer, as, and at the price of, yarn. The natural affinity of cotton for moisture is thus taken advantage of very extensively to commit what is little better than a fraud.

A STANDARD COTTON AND YARN TESTER.—The dampness of cotton and yarn is an old cause of complaint amongst spinners and manufacturers, and has been the origin of innumerable disputes in matters of account between buyers and sellers. Crude methods have hitherto been resorted to in order to test yarns for adulteration by water. A weaver's canful of weft or twist, about 5lb., has often been taken after carefully weighing and dried upon the boiler or

in the engine-house, or any other place in which the temperature was high, and after the moisture has been driven out it has been submitted to the atmosphere for a greater or less time to re-absorb what it could get. At other times whole skips of yarn have been so treated. Many other rude devices to obtain the same end have been tried, but in all there has been a want of care and accuracy in conducting the experiments, and above all of uniformity in details of weight, exposure, temperature, and atmospheric exposure, so that the knowledge that has been gained has been too fragmentary to admit of classification and the deduction of useful conclusions. Practically, therefore, no purpose has been served by them beyond the immediate one which caused them to be undertaken. The want of a sound, reliable, and scientific test has therefore, until within a few years ago, gone ungratified.

Before satisfactory conditions can be arrived at it is necessary to establish a standard of dryness upon which all agree. In conditioning houses upon the Continent this point has received a great deal of attention, especially in connection with the conditioning of silk, the most valuable of all the textile fibres. From this the discussion has travelled to woollen, cotton, jute, flax, and hemp, and the subject has been, approximately at least, settled in an authoritative way. The methods by which these conclusions were reached cannot, however, be detailed here. The point started from, however, was absolute or chemical dryness, from which natural absorption was allowed to commence. The result of numerous experiments was found to be as stated at the International Congress held in Turin in October, 1875, that the different fibres in the state of yarn absorbed moisture according to the following percentages:

Wool yarns	18 $\frac{1}{4}$ per cent.
Jute "	13 $\frac{3}{4}$ "
Hemp "	12 "

Flax	„	12	per cent.
Silk	„	11	„
Cotton	„	8½	„

These conclusions might not in the humid climate of England be found to agree with facts in the closest manner, as undoubtedly, with the greater amount of moisture regularly present in our atmosphere, all of these various fibres would take therefrom a slightly greater percentage, which would require to be allowed for, or, perhaps, necessitate a different standard.

Chemical dryness, it may be observed, is obtained by exposure to air heated to 212° F. If, therefore, to the weight obtained after subjection to this test the above percentages be added, natural dryness may be said to be fairly obtained. Any difference between the weights thus obtained and the original one will exhibit with a very close approximation the amount of moisture that has been introduced for fraudulent purposes. What has been wanted has been a ready means of performing this test, and this has been provided by a gentleman long connected with the trade in an invention that answers the requirement in this respect admirably. The appliance is a shallow rectangular copper steam chest or boiler, having a corrugated upper surface that will receive twist cops or hanks as shown in the accompanying illustration. The boiler is fitted with a condenser in which the steam is condensed and the water returned to the boiler. Hence there is no trouble in maintaining a supply of water. The whole is heated by a Bunsen burner. The yarn to be tested—1 lb., the tester being arranged to treat that quantity at a time—having been placed upon the corrugated top, the burner is lighted and the water quickly raised to the boiling point. By exposing the yarn in this manner the free moisture it contains is thrown off at the following rate: In three hours it is brought within 1 per cent. of chemical dryness, in two hours within 2 per cent. As the third hour

is almost invariably within 1 per cent., two hours' exposure is sufficient for comparative tests.

In order to facilitate the use of the tester, its inventor has compiled the following table of percentage of loss on 1 lb.:

1 lb. loss	2 oz.	=12·5	per cent.
1 lb. „	1 $\frac{7}{8}$ oz.	=11·7	„
1 lb. „	1 $\frac{3}{4}$ oz.	=10·9	„
1 lb. „	1 $\frac{5}{8}$ oz.	=10·1	„
1 lb. „	1 $\frac{1}{2}$ oz.	= 9·4	„
1 lb. „	1 $\frac{3}{8}$ oz.	= 8·6	„
1 lb. „	1 $\frac{1}{4}$ oz.	= 7·8	„
1 lb. „	1 $\frac{1}{8}$ oz.	= 7·0	„
1 lb. „	1 oz.	= 6·2	„
1 lb. „	$\frac{7}{8}$ oz.	= 5·4	„
1 lb. „	$\frac{3}{4}$ oz.	= 4·7	„
1 lb. „	$\frac{5}{8}$ oz.	= 3·9	„
1 lb. „	$\frac{1}{2}$ oz.	= 3·1	„
1 lb. „	$\frac{3}{8}$ oz.	= 2·3	„
1 lb. „	$\frac{1}{4}$ oz.	= 1·5	„
1 lb. „	$\frac{1}{8}$ oz.	= 0·8	„

One per cent. loss or gain on any standard fixed upon is on 20,000 lb. at 6d.=£5, at 9d.=£7 10s., at 1s.=£10. From these figures the value of a standard tester will be manifest. The tester occupies only a small space, being 21 in. by 10 in. and 8 in. deep. It requires very little attention, and a small amount of gas keeps it to the boiling point. It is illustrated in fig. 200.

In justice to sellers of yarns it must be observed that buyers who resort to this test will require to take into consideration and make allowance on several points that have not yet been noticed. Honest single cotton yarns by the dry air test will lose 8 per cent., by the tester in two hours 6 per cent., or say 1 lb. in two hours will lose 1 oz. In doubled yarns a larger allowance will have to be made, as the doubler is expected to return the same

weight as that delivered to him, and to hold him to this standard would be to make no allowance for waste in the process of doubling; and the allowance on this account will require to be greater in the case of coarse yarns than fine ones, because of the higher proportion of waste resulting from working them. And further: all

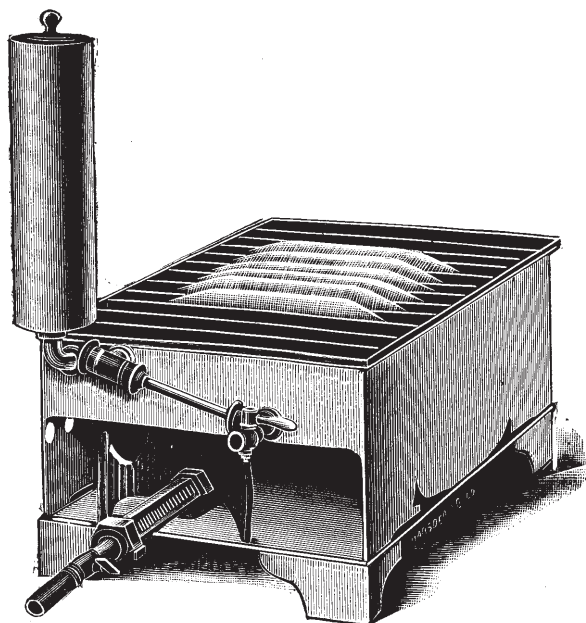

FIG. 200.—YARN TESTER FOR DAMP.

tests, it must be observed, can only be comparative, because of the fact that various classes of the same fibres differ in their hygroscopicity or power of absorbing moisture. Thus in cotton, for instance, American, Egyptian, and Surat cottons after being dried would probably be found to absorb different proportions of moisture, and

similarly the yarns made from them. Only experience and conscientious handling of this admirable instrument will, however, bring these points into full view.

This little invention will be found to be of great utility in all branches of the textile industries, and no doubt the principle it embodies will be found capable of even wider application.

TESTING COUNTS.—Wrapping or testing, to discover the counts, should be very carefully and honestly performed, in justice to both buyer and seller. For this purpose it is best to use a modern or improved reel, with a traverse motion for distributing the yarn upon its periphery instead of allowing it to run in successive layers upon each other, thereby sensibly enlarging the circumference and causing the leas to yield an incorrect result. This deceives the operator and gives rise to annoyance by causing claims to be made that can be shown to be founded upon an error.

The importance of attending to the counts of yarns, is of the greatest moment; because if the yarn should be purchased for 30's and should come in 28's, the loss in the length of thread will be 7 per cent.; and if 29's, $3\frac{1}{2}$ per cent. Supposing 40's be purchased and 38's received, the loss will be 5 per cent., and $2\frac{1}{2}$ per cent. with 39's. Yarn which is more than half a hank away from nominal counts should not be passed without a claim for compensation, and if this cannot be obtained, care should be taken that either the price paid for it should be sufficiently low to afford compensation for the loss as compared with those correctly spun, or the latter should be purchased in preference. Suppose a sufficient quantity of yarn to have been purchased for manufacturing 1,000 pieces of cloth, and that the same has been invoiced to the manufacturer, but that either by excessive moisture, coarseness of counts, or both combined, there is a loss of 5 per cent. The yield will then only be 950 pieces, the remaining weight either having gone into the 950 pieces, making them better than contracted for, or otherwise having evaporated in moisture.

In either case it is a loss to the manufacturer. This in a weaving mill containing 500 looms, making six pieces per loom per week, will be equal to a loss of 7,500 pieces, representing, at 6s. per piece, a sum of over £2,150 per annum. This sum, it will be obvious, means the difference between success and failure.

PATENT YARN TESTING AND INSPECTING MACHINE.—The best machine for testing the counts that we have seen is the patent yarn testing and inspecting machine manufactured by Messrs. Henry Wallwork and Co., Charter Street, Manchester. This machine enables those interested in the buying and selling of yarns to thoroughly test their qualities not only in the counts but also in the evenness, and to keep a visible record, by which they can also make a comparison with the same or other yarns at any time. This machine supersedes the ordinary wrap reel. Instead of winding the yarn to be tested on a reel, it is wound helically on a flat piece of blank cardboard, so that each convolution lies close to the board, and there is no overlapping; every layer is therefore of precisely the same length, and separate from all the other layers. Lying against a black background, every portion can therefore be easily seen and all the flaws or bad places instantly detected. We give two illustrations of this improved reel.

Fig. 201 shows the machine as used for obtaining the ordinary lea for weighing to determine the counts. It will be seen that a vertical standard carrying all the mechanism is secured to a good wooden base. The shaft to the right carries at its end four double prongs, or clips, into which the black cardboard is inserted, as shown in the illustration. This shaft also carries a worm wheel working into the indicator dial for registering the number of revolutions. A second shaft, to the left of the vertical standard, and driven from the first shaft by means of a cord, is screwed at its projecting end, the pitch being sixteen threads to the inch; on this screw hangs loosely the

handle for guiding the thread, seen in the illustration, which travels along as the screw revolves. When the handle has traversed the whole length of the screw it can be lifted and put back to the other end at once, when it will be in a position to start again. In this manner the convolutions of the thread are laid nearly side by side, and when the lea, consisting of 80 threads, has been wound, the board is full. The number of turns are counted by the dial and pointer in the usual manner. To take off the

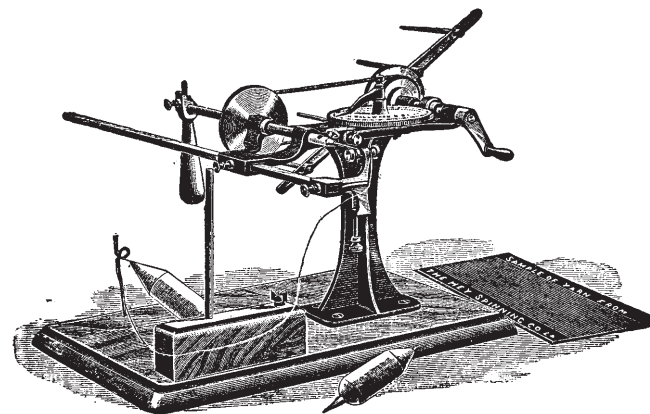

FIG. 201.—YARN TESTER FOR COUNTS.

lea, all that is required is to slide the template out of the clips, when by bending a little the threads are easily removed.

When it is desired only to inspect the yarn, it is not necessary to lay the threads so closely together as it is when winding for the lea; in this case, then, the cord seen in fig. 201 is put on a larger pulley, the effect of which is to turn the screw faster in comparison with the template, and so spread out the threads more. In fig. 201 a card is shown at the base of the machine filled with yarn;

in fig. 202 a similar card is shown with the yarn wound for inspection only. In this case the distance between the threads is about an eighth of an inch; all the defects, such as knots, snarls, dirt, or soft places, will be very well shown up. These cards offer a very convenient means of keeping samples for future reference or comparison, or for comparison of one maker's yarn with another. In taking samples for comparison, or for keeping, the ends of the cards should be gummed, so that when the yarn is once placed upon them it will retain its position. The machine is arranged to wind from spools, bobbins, or cops. By means of the long rod attachment, seen in fig. 202, the machine can be arranged to test the elasticity of yarn. For this purpose the rod is fixed as shown, and the yarn is secured to it at one end and to the arm working on the screw at the other, the length of thread between the two terminals being about 12 in., or any other suitable length. The pointer is set to zero, and the handle then turned as before; the loose arm moves up the screw at a known rate, and when the yarn breaks, the amount of stretch is registered on the dial. The stretch may be registered as so many sixteenths of an inch per foot, or in percentages, or in any other way that may be desired. It should be mentioned that the tension of the thread, while under this test, is prevented from exceeding a certain amount by means of a small weight attached to the end.

Again, another use to which this machine may be put is to determine the amount of twist in doubled yarn. For this purpose the long rod seen in fig. 202 is reversed, and the doubled thread is clamped by the specially-prepared end of the screwed spindle. The pointer on the dial is set to zero, and the handle then turned as before, until all the twist has been taken out, when the number of turns made is registered by the dial; the length of yarn operated on must be known in order to determine the number of twists per inch, so that the bar is marked to give one inch, two inches, or three inches, as may be desired. In

very fine counts the twist can be followed up by a needle, and so it will be known when it has all been removed.

The makers also supply a small spring balance attachment for testing the breaking strength of single threads. This balance is arranged to be hung from the long rod, shown in fig. 201, which can be fixed vertically. When the thread breaks, a catch prevents the spring from shooting back until the reading has been taken. Such a test as

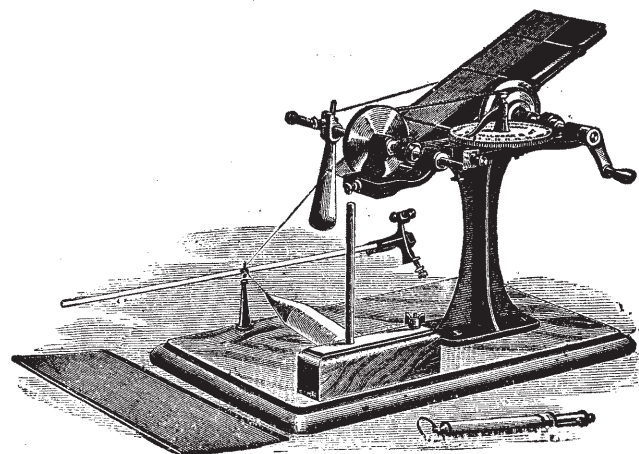

FIG. 202.—YARN TESTER. SHOWING HOW TO TAKE SAMPLES FOR QUALITY.

this will show where the weak places of the yarn are (if there are any), though of course to get the average strength a number of tests of single threads must be made to the average taken, or resort may be had to the ordinary yarn tester. An additional attachment for testing the strength of eighty threads at once is provided, which seems to be very efficient. It would be well if more attention were paid to tests of single threads, as this is the true way to find out the imperfections. To test eighty threads

at once is very well, but it tells absolutely nothing as to the variations of strength in each particular length of thread; and the sooner this is recognized the sooner the imperfections will be removed. In actual practical work the strain comes upon the single thread, and never upon eighty conjointly, and it will break at the weakest place.

In the manufacture of some of the better classes of cotton goods, especially those designed for white finishes, it is highly desirable to have an accurate and ready means of testing the amount of twist in single yarns as well as twofolds. For this purpose the tester illustrated in fig. 203

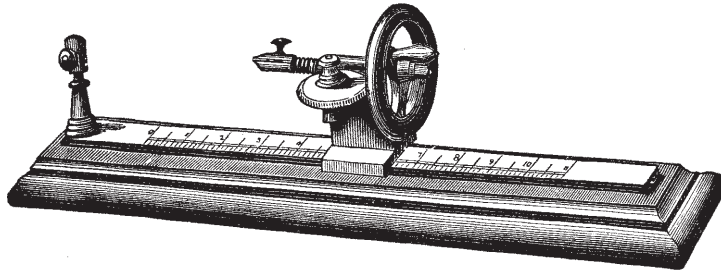

FIG. 203.—TWIST TESTER.

is a useful instrument. As will be seen, it consists of a base with measurements upon it. At the left is a fixed vertical standard carrying a clip. The one on the right is a movable standard with a small horizontal spindle carrying a similar clip to that just mentioned. This spindle has also a worm upon it, gearing into the bevelled edge of an indicator plate, which registers the number of turns taken out of the yarn. It is operated by the hand-wheel.

The ordinary method of testing the counts of yarn by wrapping is, however, very defective, and ought never to be relied upon alone. As will be obvious, to wrap a few leas from a few cops from each skip of a delivery of yarn, even when this is done regularly, which is far from being

always the case, is practically no test at all; the inference being purely an assumption when the conclusion is drawn that all the remainder of the yarn is the same. There are numerous ways in which errors, carelessness, wilful mischief, and even fraud, might vitiate the result. Suppose that slivers of different hanks get mixed in the drawing frame, or drawings, slubbings, or rovings, in the subsequent processes by which serious irregularities would be introduced; the test by wrapping would reach none of these in an effectual manner. As previously stated, in the spinning process it is now customary to spin yarns one to two hanks finer than the nominal counts, and to condition or reduce the hank to the proper point by damping. When the wrapping is done before the yarn is tested for damp, the result is thoroughly incorrect. Formerly the practice was to spin the yarn one to two hanks below nominal counts, and as much further as manufacturers could be induced to accept without demanding allowances. In order to prevent discovery of this, in some flagrant instances, the change wheels have been altered, and the top of the cops for a lea or two have been spun correctly. No imputation is made that such practices now exist; indeed, it is highly improbable that they do.

The only satisfactory way of ascertaining the counts of yarn is to test the bulk, and this can only be done by calculation. It can be done perfectly in the second process of manufacturing—that of warping. In the instances where ball warping is still practised, it is only necessary to work out by calculation what the weight of a warp should be; then to weigh the warps produced, and after making a very slight allowance for loss in the friction of winding and stretch in warping, the divergence between the calculated and the actual weight will show how much and in what direction the yarn is wrong in counts. In the much more common method, which is almost universal throughout the great weaving districts of East Lancashire—that of beam warping—all the empty beams

should be carefully weighed, and the weight painted upon the outside of the flanges. Calculations should then be made of the weights of the counts of yarns in use for the different numbers of ends ordinarily worked for three, four, or five wraps, as the case may be. All the warpers' full beams should then be weighed, the tare of the empty beam deducted, and the result compared with the calculated weight. This, as before, will show any departure in bulk from the counts. This method possesses the further advantage of getting a true test of the counts, even in the case where damping may have been suspected, as in the comparatively warm dry air of the winding and warping rooms all excessive moisture will have been evaporated. Of course it will not serve as a test for dampness.

Where the above practice is adopted and the results correctly recorded, it will be of great assistance in the production of uniform weights of cloth in the weaving shed, because in making up a set of back beams for the sizing frame, uniform aggregate weights can be made by sorting the beams. This will eliminate one important source of irregularity, because when various marks of yarn are purchased by the manufacturer and worked without due care, it is no infrequent occurrence for sets of back beams for the sizing-frame to vary in weight from 10 to 20 lbs., which variation is considerably increased by the process of sizing. Hence it follows that in the weaving-shed all attempts to keep uniform weights of cloth by means of using different counts of weft are so frequently conspicuous failures. The plan stated here, if carefully followed, will give uniformly correct weights to the weavers' beams continuously, or at least with such slight variations as to be inappreciable in the cloth.

TESTING YARNS FOR STRENGTH.—It only now remains to give a brief description of testing yarns for strength. This is often judged by hand with great accuracy by experienced persons. The test is performed by taking a cop of twist in the left hand, drawing a length of the yarn from it

with the right, pulling it tight and then carefully observing its amount of elasticity and of force required to break it. This is repeated a number of times from the same cop in order to discover whether its strength is uniform or not. Several cops should be tested in this manner to ascertain if the threads are uniform with one another. This method at the same time can be used for inspecting the yarn as to its evenness. A glance thrown along its line, especially when holding it against a dark background, will show very easily whether there are thick and thin places alternating, or occasional thick or thin places alone. When the eye cannot detect any of these faults, the thread should be allowed to hang slack in a curve. In this state should it run into a kink, the thinnest and weakest place will be found there, as will be seen on stretching it again and pulling it till it breaks, which it nearly always will do at the point where it ran into a kink. In all uneven yarns the thick portions are the least twisted, and when very uneven these will be found to have very little twist at all in them, so little indeed that they form "soft" places at which the thread will not break with a snap, but the fibres will at that point come apart gliding over one another. This is owing to their imperfect union and compression, the twist or twine which should have accomplished this having run into the thinner portions of the thread. On the other hand if thin places be present in the yarn it will be found that they have more than their proper amount of twist. These will be hard and inelastic, and having fewer fibres in them than the proper quantity they will break with a much less strength of pull than they ought to do. Uneven yarn that shows thick and thin places, or soft and hard twisted ones, should always be avoided, especially for use as warps. The faults manifested in the examination of the cop as described will be accentuated in the process of actual work. The person who is entrusted with the duty of buying yarns should make a careful study of this method of testing because it needs no mechanical

aids to perform it, and enables him wherever he be to apply it to any samples submitted to him; and to very accurately decide whether or not they will be suitable for his requirements.

This method of examination is also an excellent one for ascertaining other defects in yarn. It very clearly shows the presence of "neps," which are very detrimental. These are fibres of cotton that have been caught between two surfaces of moving parts of the machinery in one of the preparatory processes of spinning or in the ginning process before them, owing to bad setting or subsequent derangement. Fibres thus caught are nipped and rolled up into little pellets, like grains of sand in size, and cannot afterwards be extracted. When the material comes to be spun, these nips or "neps," as they are corruptly called, are thrown to the surface of the thread, and are easily visible to the naked eye, or to a sensitive touch when the fingers are drawn over a length of the thread. Their presence greatly deteriorates the quality of the cloth in which they enter, because then they all come to the surface, and when the hand is passed over the surface of a cloth where they are present, it will be found to be remarkably rough. "Neppy" yarns ought to be carefully avoided.

The hand testing of yarns is also the best method for discovering other serious faults in them. Nothing enables a user of yarn to discover the character of a fault better than the hand test. For instance, when the cotton used is irregular in staple or length of fibre, short and long fibres entering into the composition of the yarns, the fact is easily detected by the fault which results. It is impossible to set the drawing rollers in the mule or spinning machine to properly work two lengths at the same time, for if they were set to work the long lengths, the short ones would be thrown out and far too much waste would be the result. If they were set to work the short lengths, less waste would be made, but another serious fault would arise. Such long fibres as were not broken would be worked

up at a slack tension with the short fibres at a proper one, and thus what is termed "corkscrewing" would take place. When this yarn came to be tested in the hand, the person testing it would find that instead of breaking with one sharp snap, it would make two little cracks in succession; or several little cracks in succession would be heard from different parts of the yarn before complete breakage occurred. These are termed "crackers," and indicate that the short fibres at proper tension where they are found side by side with long fibres at a slack tension have been broken, and that the thread requires a second or continuing pull to break the slack long fibres. Yarn of this kind is very poor, and will cause a good deal of trouble, and make bad cloth because of its weakness. This weakness arises from the fact that its strength lies in two small units, easily broken separately, instead of one larger unit giving the maximum of strength through perfect union.

It will be seen from this that we esteem the hand test of yarn very highly.

There is, however, a mechanical tester of the strength of yarn that may be resorted to

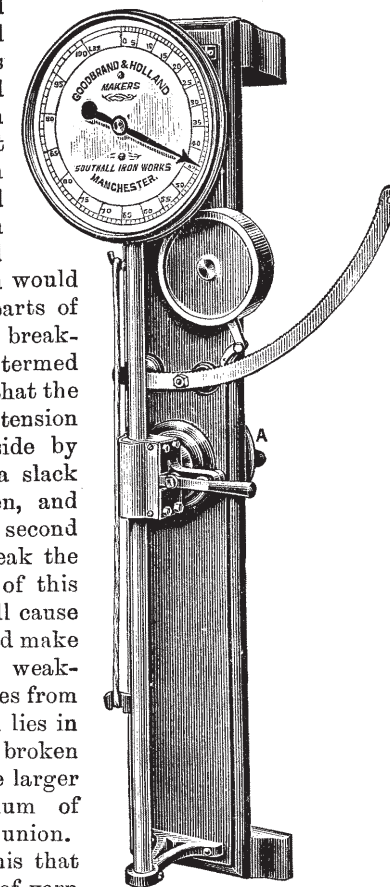

FIG. 204.—YARN STRENGTH TESTER.

if desired. This consists of a machine composed of a wheel, worm and screw, a fixed and movable hook for the reception of the lea, and an indicator plate with index finger. When the lea is put upon the hooks, the bottom hook is wound down by the hand-wheel, A, adapted also for power, and as the strain upon the yarn increases it is registered by the index finger upon the plate. Immediately breakage occurs the pointer ceases to rise, and remains fixed at the highest position attained, which shows the weight in lbs. at which it has broken. This system gives the experimenter the average strength of 120 threads which are contained in the lea. It is a useful guide for rough approximations to the quality of yarns, but as in the processes of manufacture they are never subjected to such aggregate tests it is not a reliable one. It is shown in fig. 204.

It should be noted that the only true test of strength quality is that of a single thread, as it is to the units that the strain of actual work is applied, and this can only be effectively applied in actual work. It will thus be obvious that every new yarn should be carefully watched until it has established its reliability.

CONDITIONING OF YARNS.—In all cases a yarn receipt-book should be kept, in which entries should be made of all parcels of yarn coming to hand. It should possess columns for the entry of the mark of the spinning, the gross, tare, and net weights of each package, the date when received into stock, and the nominal and actual counts. The store-room should be cool and dry, but not excessively so, as this would not improve the quality of the yarn. When the yarn is taken out of store for use it ought to be weighed again, in order to ascertain how much weight may have been lost by the evaporation of moisture. The store-room may thus usefully be made a conditioning-room. The quantity of water cotton yarns naturally contain is about $8\frac{1}{2}$ per cent., this differing according to the hygrometric condition of the atmosphere. Any excess of moisture over this average should be claimed for, and, if not allowed, the spinning in which it occurs ought to be avoided.

CHAPTER XIII.

THE PROCESSES OF MANUFACTURING.

Definitions: Winding; Warping; Sizeing; Drawing; Weaving.—Peculiar system of paying winders; rates of wages.—Details of work; careful supervision required.—Winding weft yarns on pirns; pirn machines, *illustrated*.—Multiple yarn winding.—Proportion of winding spindles for looms.—Warping; points to be regarded; the weighing of beams.—Proportion of machines for looms.—Sizeing; its great importance; ball-warp sizeing; cylinder, and air-drying machines; important points; bad work; good work; proper drying; piece-marking; risks of loss accruing.—An improved piece-marker, *illustrated*.—The beam presser, *illustrated*; its advantages.—Drawing and twisting-in described.—Proper storage of beams, and healds and reeds.—Weaving; its chief essentials good weavers and good machinery.—The “gating” of new looms; requisites.—The tackler’s bench.—Pickers, and how to season them.—Testing a new loom.—The shuttle and its importance.—The setting of the various parts of the loom.—The warp shed.—The pacing of the warp; the rope.—Simple and compound levers.—Hopwood’s improved pacing motion.—Combined beam pike, ruffle, and flange.—The ordinary taking-up gear; details of a common dividend.—Pickles’ and Sagar’s gear; their advantages.—THE WAREHOUSE: the plating machine, *illustrated*.—Making-up.—Bundle pressing; improved bundle press, *illustrated*.—Delivery of the cloth.

AFTER the exposition already given of the development of the manufacturing processes from the primitive art of weaving, and of the series of machines employed therein, from the simplest form of the original handcraft loom to their present degree of comparative perfection, accompanied as it has been by a clear statement of the function of each machine and every part thereof, from which it is hoped that the reader will have gleaned a thorough comprehension of their separate and joint purposes, the description of the processes in which they are

employed, will not require to be dealt with in any elaborate manner. To recall the names and meaning of each of these to the mind of the reader, we subjoin a brief definition of each.

Manufacturing, as ordinarily understood, consists of five processes, as follows:

1st. "Winding."—This is the operation of transferring yarns—usually warp yarns—from the cop or hank, in which state they are mostly purchased, to bobbins, to prepare them for the next stage. Weft yarns are reeled preparatory to dyeing or bleaching.

2nd. "Warping."—In this stage a given number of bobbins—generally 300 to 500—are placed in a creel, and the threads are wound thence in parallel order upon a large beam, to the length of from 3,000 to 5,000 yards, or such other length as may be required. This is the plan pursued where the slasher sizeing machine is used. Where the old system of ball-sizeing is retained, but which is now becoming rare, the method is different. Sometimes, and increasingly so since the introduction of ring spinning, yarn is bought both upon the beam and in the form of "cheeses" or section warps.

3rd. "Sizeing."—This consists in immersing the warp yarns in a semi-fluid composition, consisting of water, flour, starch, and other ingredients. The object is, or ought to be, to lay down the projecting fibres and consolidate the threads to enable them the better to withstand the friction and strain incident to the subsequent process of weaving; but this in too many cases, owing to the severity of competition, has given place to a desire to increase the weight of the warp.

4th. "Drawing-in, looming, or twisting-in, the warp."—This is simply furnishing the warp with the healds or harness, to make it ready for the loom.

5th. "Weaving."—This is the chief process of the manufacturing division of the trade, and sometimes gives its name to the group. It is the art of interlacing threads

in such a manner as to make a web or texture. It is subdivided into branches—plain, twill, figure, and leno weaving. All these arise from the order in which the threads of the warp are opened to receive the weft or filling which composes the cross threads of the texture. The principles have already been fully described and expounded.

These are the principal processes; there are several subordinate or accessory ones. We may now deal with them a little more at length, and from the practical side, supplying at the same time such matter as the plan of this essay did not permit to be put forward previously.

WINDERS' YARN.—It is a general custom in manufacturing establishments to weigh out given quantities of yarn to winders, the amount varying with the counts. These quantities are technically called "weighs," and the usual method is to pay 12*d.* per weigh, the wages of the winder being reckoned upon the number of the weighs she takes during the working week, which is generally reckoned from Wednesday to Wednesday, or Thursday to Thursday. It will be obvious that with the lowness of the counts, which represents shortness of length in the yarn, and consequently less time if not work in winding, the weight given out will be greater; and conversely as the counts rise, the weight to be worked for 1*s.* will be reduced. This principle always controls the weight of the "weigh." The "Blackburn Standard List," which until recently governed the rate of wages in the Blackburn and East Lancashire districts, gives the following as the weights of the various counts to be wound for 12*d.*:

Counts.	Lb. for 12 <i>d.</i>	Counts.	Lb. for 12 <i>d.</i>
18's . . .	55	38's . . .	32
20's . . .	52	40's . . .	31
22's . . .	49	46's . . .	27½
24's . . .	45½	50's . . .	26
26's . . .	42½	60's . . .	22
28's . . .	40	70's . . .	19
30's . . .	38	80's . . .	16½
32's . . .	36	90's . . .	14½
34's . . .	34½	100's . . .	13
36's . . .	33½		

These figures have been incorporated into the new uniform list and are binding at the present time, but the prices are subject to a reduction of 10 per cent.

WINDING.—In the winding-room of a mill there is not much that calls for remark, beyond pointing out that every precaution should be taken to prevent the making of an excessive amount of waste. This is the first stage of the manufacturing process, and the defects of the yarn are here first encountered. "Single," bad piecings, defectively cleaned, and roller-damaged yarn, may always be discovered here. The winding-room, therefore, requires the careful attention of the manager, but complaints must not be encouraged from the operatives, or it will be speedily found that yarn sufficiently good to suit them cannot be purchased. Waste in excess is frequently produced by careless operatives, and especially by learners skewering cops badly or entangling hanks. Too much severity, however, should not be exercised, as this will lead to waste being secretly carried away, or trampled under foot, which increases the loss. Attention should be directed to preventing the operatives making large knots in piecing up threads, as these are frequently the cause of breakages and defects in succeeding stages. Each winder, therefore, ought to chalk-mark or number her bobbins, so

that when bad work is found it can be traced to the responsible party.

The work in the winding-room should be carefully supervised by the winding master, as, though the operatives work by piece, the method used is an inversion of the ordinary one. The tale of their labour is the amount of yarn delivered to them to wind, and not the amount of work they have performed and have delivered to some one else. Thus there is nothing to prevent the winders taking "weighs" of yarn, and so making up a good week's wages, without having performed the work for which they receive them, except the strict supervision of the person in charge, whose duty it is to prevent this. If this is neglected there is risk that some of the winders may accumulate yarn upon and about their part of the machine and receive pay for it before they have wound it. Such accumulations are always a temptation to get rid of it by improper means, which should never be permitted.

In establishments in which different counts of yarn are used, care is required that these do not get mixed. The only way to avoid this is to have the bobbins painted different colours: one colour for each count, that these colours should not be departed from, and that they should not be allowed to get mixed in the working.

In the class of manufactories to which our remarks mainly apply, single yarn warps are almost invariably used, and therefore single yarn winding from the cop, or bobbin, or rewinding from the hank to the warper's bobbin is the only class of winding in use. Reeling for bleaching and dyeing purposes has been described in a preceding chapter.

In places where white or coloured yarns are used for wefts, the rewinding from the hank after bleaching or dyeing calls for a few remarks. The yarn in this case is wound upon pirn bobbins, which are coned at the top in order to allow the yarn to be drawn off at the top when the bobbin is placed in the shuttle. Of course pirn bobbins

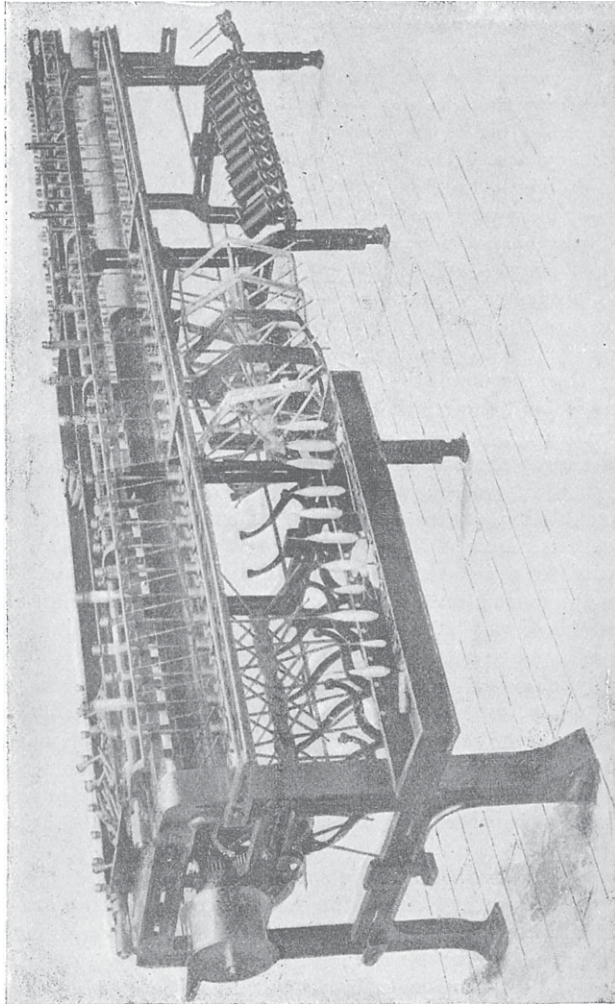

FIG. 205.—CUP PIRN WINDING MACHINE, MOUNTED FOR WINDING FROM COFS, HANKS, AND WINDERS' BOBBINS.

are made of the proper dimensions for that purpose, so that when filled with yarn they may not exceed the capacity of the shuttle to receive them. There are several types of pirn winding machines, of which we give illustrations. In fig. 205 is shown a cup machine equipped for winding pirns from cop yarn on the left-hand side of the machine; from hanks in the centre; and from winders bobbins on the right. These several methods are called into requisition in different establishments, but rarely all in one. The student must not erroneously conclude that all the different methods are usually combined in one machine, it being rare that they are arranged for more than one, or at most two. This frame of course would wind equally well from ring frame bobbins. It receives its distinctive name of a cup-winding machine, because it has a cup or hollow cone, the cone being point downwards, in which to receive the pirn for filling. This inverted cone practically constitutes a mould, in which during winding the cone of the pirn is formed. The details of the cup machine are fully shewn in figs. 206, 207 respectively, shewing end and side elevation, and method of gearing. Another type of pirn winder is termed the disc machine, so named from the use of a revolving disc plate with a bevelled edge, which, being placed in contact with the pirn bobbin, causes it to revolve and form a cone as before.

In other branches of the trade somewhat distant from that under review, twofold, threefold, or quadruple yarn winding is required. In these the winding process becomes more complex, and requires more care and skill to insure satisfactory results. Special machines, too, are called into requisition. These are much more intricate, and are fitted with ingenious arrangements to insure the winding of the two or more threads at absolutely uniform tensions, and also to instantly stop a bobbin when any single thread of a series being wound upon it breaks or becomes exhausted.

Where doubling or multiple yarn winding occurs it is