

GRAMMAR
OF
TEXTILE
DESIGN
NISBET

GRAMMAR
OF
TEXTILE DESIGN

H. NISBET

TARAPOREVALA

GRAMMAR
OF
TEXTILE DESIGN

New, Revised and Greatly Enlarged Edition

WEAVING CALCULATIONS

By R. SEN, B.Sc. (Cal.), B.Sc. Tech. (Manc.), A.M.C.T.

29 Illustrations.

This is an up-to-date and accurate book on weaving calculations. All the different methods of calculation, derived from fundamental principles, have been explained and illustrated whenever possible by examples based on data commonly used in practice. No advanced knowledge of mathematics on the part of the reader is essential in order to be able to understand this book. In case of important calculations, intricate details have also been included as these help in actual practice. The work is fully illustrated, the many illustrations greatly helping in simplifying the text.

THE MECHANISM OF WEAVING

By THOMAS W. FOX, M.Sc. Tech.

Over 600 Pages.

285 Illus.

During recent years several admirable books have been written on weaving, but it has been too much the custom to consider designing, fabric structure, and the calculations relating thereto, as the most important parts of the subject. Hence, only one treatise has appeared within the last twenty years in which the mechanical side of weaving has not been subordinated to the structural side.

The present treatise is designed to supply this deficiency, and to place within the student's reach exact and practical information bearing upon the principles of weaving as exemplified in the various processes of the trade. If this book assists in some small degree to give students a better knowledge of the textile industry, the author will feel that his labour has not been in vain.

Within the compass of this volume it is manifestly impossible to deal fully with all kinds of weaving mechanism. Some branches of weaving have been unavoidably passed over, but an effort has been made to include the leading types of machinery.

GRAMMAR
OF
TEXTILE DESIGN

BY
H. NISBET, F.T.I.

Textile Technologist and Consultant

AUTHOR OF "PRELIMINARY OPERATIONS OF WEAVING" (3 VOLS.),
"A TREATISE ON SIZING," "THE MANUFACTURE OF TERRY PILE FABRICS,"
"AUTOMATIC LOOMS"

THIRD EDITION, REVISED AND ENLARGED

With 669 Illustrations

D. B. TARAPOREVALA SONS & CO. PVT. LTD.
TREASURE HOUSE OF BOOKS
210, DR. DADABHAI NAOROJI ROAD, BOMBAY

PREFACE TO THE THIRD EDITION.

THE request for a third edition of this treatise is a source of gratification to the author as affording some evidence that, as a text-book and a work of reference, it supplies the needs of students, manufacturers and others for whom it is written.

In addition to the revision of parts of the original text, the present volume is enlarged by 50 additional pages to a total of 553; and 32 new figures to a total of 669. Descriptions are also given, in Chapter IX, of several American types of flat steel doups for heald and Jacquard harnesses for gauze, leno and other varieties of cross-weaving; and Chapter XI introduces a new warp ondulé motion applicable to ordinary looms.

The increasing importance and rapid development of the artificial silk industry is fully recognised by the addition of an entirely new chapter (XIX) of 38 pages, with illustrations reproduced from 15 actual examples of cloth illustrating the decorative value of artificial silk in the embellishment of textile fabrics.

This chapter also describes the essential features of the chief types of artificial silk and their reaction with dyes in the production of multi-colour effects by cross-dyeing. It also gives a comparison of the properties of natural and artificial silk, and explains the uses of artificial silk staple fibres.

It is hoped that this treatise will be of some service in advancing the interests of the weaving industry.

H. NISBET.

WEST DIDSBURY, MANCHESTER,

PREFACE TO THE SECOND EDITION.

IN responding to the demand for a second edition of this treatise, the author has taken the opportunity to extend several chapters of the previous edition, and also to enlarge its scope by the addition of eight new chapters.

The chapter treating of terry pile fabrics is augmented by descriptions of several distinct modifications of terry pile motions; a description of figured terry weaving by means of the Jacquard machine; and also of a method of weaving terry pile fabrics in an ordinary "fast-reed" loom without the aid of a "terry motion" for that purpose.

In the eight new chapters, there are given detailed descriptions, accompanied by much useful and practical information, relating to the structure, designing, and manufacture of the principal types of textile fabrics comprising the following commercial varieties: leno brocade; brocade; damask; Alhambra; piqué or toilet welt; matelasse; toilet quilting; patent satin or Mitcheline; tapestry; and Scotch or Kidderminster carpet.

Embracing, as it does, a much wider range than that of its predecessor, the present volume will prove even more helpful as a text-book for students of weaving and designing, and also as a work of reference for all who are interested in, or desire information relating to, the construction, production, and use of textile fabrics.

HARRY NISBET.

PREFACE TO THE FIRST EDITION.

The Grammar of Textile Design is a treatise upon the Fundamental Principles of Structural Design in Woven Fabrics, and the application of those principles in the production of various types of cloth.

It has been chiefly prepared as a text-book for students of weaving and designing in all branches of the weaving trade, and contains much information of practical utility to designers, salesmen, manufacturers, and others, to whom a knowledge of the construction, characteristic features, and uses of textile fabrics will be helpful.

In the descriptions of fabrics that are produced by the aid of special mechanical devices, these are briefly described and illustrated by scale diagrams, and include descriptions of three types of steel-wire doup harnesses for cross-weaving; a loom for weaving leno fabrics in which warp ends are crossed by a system of douping in *front* of the reed; and a loom for weaving ondulé fabrics in which warp ends, and sometimes picks of weft, are caused to assume undulating or wavy lines in the direction of warp, or weft, respectively.

HARRY NISBET.

CONTENTS.

CHAPTER I.

INTRODUCTION.

General Principle of Fabric Structure (§§ 1-4) and the use of Design Paper (§ 5) - - - - - pages 1-5

CHAPTER II.

THE PLAIN WEAVE AND ITS MODIFICATIONS.

The Plain, Calico, or Tabby Weave (§ 6). Firmness of Texture (§ 7). Variety of Texture (§ 8). Variety of Form: Ribbed Fabrics (§§ 9-13). Corded Fabrics (§ 14). Matt Weaves (§§ 15, 16) - - - pages 6-23

CHAPTER III.

TWILL AND KINDRED WEAVES.

Classification of Twill Weaves (§ 17). **1. Continuous Twills:** (a) *Warp-face Twills* (§ 18). (b) *West-face Twills* (§ 19). (c) *Warp and West-face Twills* (§ 20). The Angle of Twill (§ 21). Influences affecting the Prominence of Twill and Kindred Weaves: (a) *Character of Weave*, (b) *Character of Yarn*, (c) *Number of Threads per Inch*, (d) *Direction of Twill in Relation to the Direction of Twist in Yarn* (§§ 22-26). **2. Zigzag or Wavy Twills** (§§ 27-29). **3. Rearranged Twills:** Satin Weaves (§§ 30-32). Table of Intervals of Selection for the Construction of Satin Weaves (§ 32). Corkscrew Twills (§§ 33, 34). Rearrangement of Twill Weaves on Satin and other Bases (§§ 35, 36). **4. Combined Twills** (§ 37). **5. Broken Twills** (§ 38). **6. Figured or Ornamented Twills** (§ 39) - - - - - pages 24-77

CHAPTER IV.

DIAMOND AND KINDRED WEAVES.

Diamond Weaves (§ 40). Honeycomb and Kindred Weaves (§ 41). Brighton Weaves (§ 42). Sponge Weaves (§ 43). Huck-a-Back and Kindred Weaves (§ 44). Grecian Weaves (§ 45). Linear Zigzag or Spider Weaves (§ 46). Crêpe or Oatmeal Weaves (§§ 47, 48) - - - - - pages 78-109

CHAPTER V.

BEDFORD CORDS.

Plain Calico-ribbed Bedford Cords; also Plain Twill-ribbed Bedford Cords (§§ 49, 51). Figured Bedford Cords (§§ 52, 53). Tabulated Data of Particulars relating to the Manufacture of Seventeen Varieties of Bedford Cord Fabrics described in this Chapter (§ 54) - pages 110-125

CHAPTER VI.

BACKED FABRICS.

Weft-backed Fabrics (§ 55). Warp-backed Fabrics (§ 56). Reversible or Double-faced Fabrics (§ 57) - pages 126-132

CHAPTER VII.

FUSTIANS.

Varieties of Fustians (§ 58). Imperial or Swansdown (§ 59). Canton or Diagonal (§ 60). Moleskin (§ 61). Beaverteen (§ 62). **Velveteen** and **Velveteen Cutting** (§§ 63-71). Ribbed or Corded Velveteen (§ 72). Figured Velveteen (§§ 73, 74). **Corduroy** (§§ 75, 76). Figured Corduroy (§ 77). Corduroy Cutting Machines (§§ 78, 79) - pages 133-168

CHAPTER VIII.

TERRY AND LOOP PILE FABRICS.

Methods of Producing Terry Pile on Textile Fabrics (§§ 80, 81). Terry Pile Motions (§§ 82, 83). Holden's Terry Motion (§ 84). Lister and Carter's Terry Motion (§ 85). Dugdale's Terry Motion (§ 86). Smith's Terry Motion (§ 87). Hacking's Terry Motion (§ 88). Varieties of **Plain Terry Pile Fabrics** (§ 89). Three-pick Terry Fabric (§ 90). Four-pick and Five-pick Terry Fabrics (§ 91). Six-pick Terry Fabric (§ 92). **Figured Terry Pile Fabrics** (§ 93). Terry or Twin Jacquard Machines (§ 94). Draft and Shedding Plans for Three-, Four-, and Five-pick Figured Terry Fabrics (§ 95). Methods of Preparing Applied Designs for Figured Terry Fabrics (§ 96). **Fast Reed Terry Pile Weaving** (§§ 97, 98). Practical Details of Terry Pile Weaving (§ 99). **Loop Pile Fabrics** (§ 100) - pages 169-210

CHAPTER IX.

GAUZE AND NET LENO FABRICS.

Gauze, Net Leno, and Leno Brocade Varieties of Cross-Weaving (§ 101). Plain Gauze and a Heald Gauze or Leno Harness (§§ 102, 103). Cellular Gauze Fabrics (§ 104). Net Leno Fabrics (§§ 105-107). Gauze

and Net Leno Figuring by means of several Back Standard Healds to each Doup Heald (§§ 108-116). **Leno Specialities Produced by a System of Crossing Warp Ends in front of the Reed** (§117). A Device for the Production of Special Leno Effects (§ 118). **Full-cross Leno Fabrics** (§ 119). Relative Merits of a Top and a Bottom-doup Harness (§ 120). Relative Merits of Different Types of Dobbies for Gauze and Leno Fabrics (§ 121). Shaking Devices for Leno Weaving (§§ 122-126). **Practical Details of Leno Weaving** (§§ 127-130). **Tempered Steel-wire Doup Harnesses for Cross-weaving** (§§ 131-132). **Flat Steel Doup Healds**. Their Application and Method of Operation (§§ 133-135). **Marquisette Lenos** in which **Two Threads Cross Two** (§ 136). Flat Steel Jacquard Doup Harness (§ 137). Limitations Imposed by the Use of a Steel Doup Harness (§ 138). Mock or Imitation Leno Effects (§ 139)

pages 211-278

CHAPTER X.

FIGURED LENO BROCADE FABRICS.

Varieties of Leno Brocade Fabrics (§ 140). Essential Features of a Leno Brocade Jacquard Harness (§ 141). Formation of "Neutral," "Open," and "Cross" Warp Sheds (§ 142). Different Schemes of Crossing Warp Threads (§§ 143-144). **Various Types and Modifications of Leno Jacquard Machines and Harnesses** (§§ 145-149). Devoge's Special Modifications (§§ 148-149). **Various Methods of Preparing Leno Brocade Designs** and also of **Cutting the Pattern Cards** therefrom (§§ 150-155) - pages 279-312

CHAPTER XI.

TISSUE, LAPPET, AND SWIVEL FIGURED FABRICS: ALSO ONDULE FABRICS.

Tissue Figured Fabrics (§ 156). Madras Muslin Fabrics (§§ 157-158). Lappet Figured Fabrics (§§ 159-161). Cross-thread Lappet Figuring (§ 162). Spot Lappet Figuring (§ 163). **Swivel Figured Fabrics** (§ 164). **Warp Ondulé Fabrics**; also Special Types of Reeds for their Production (§ 165). **Special Loom Attachments for the Development of Warp Ondulé Effects; Foulds' Ondulé Loom** (§ 166). **Fielden's Ondulé Motion** Adapted to the Ordinary Types of Looms (§§ 167-168). **Weft Ondulé Effects** and Methods of Producing them (§§ 169-170) - pages 313-347

CHAPTER XII.

BROCADE FABRICS.

Weft Brocade Figuring (§ 171). Method of Preparing Applied Designs for Weft-figured Brocade Fabrics (§ 172). "Split-shed" Jacquard Figuring Harness for Brocade Fabrics (§ 173). Warp and Weft-figured Brocade Fabrics; also Method of Preparing Applied Designs for these Fabrics (§§ 174-176). Brocade Figuring with Extra Warp Threads and Extra Picks of Weft (§ 177). Extra Warp Figuring (§ 178). Extra Weft Figuring (§ 179) - pages 348-371

CHAPTER XIII.

DAMASK FABRICS.

Varieties and Essential Features of Damask Fabrics (§§ 180-181). The Compound Presser Harness (§§ 182-184). Damask or Twilling Jacquard Machines (§ 185). The Beasbrook Damask or Twilling Machine (§ 186). Method of Preparing Applied Damask Designs (§§ 187-189). Compound Damask Fabrics (§§ 190-191)

pages 372-399

CHAPTER XIV.

ALHAMBRA AND KINDRED FABRICS.

Varieties and Characteristic Features of Alhambra Fabrics; also the Preparation of Applied Alhambra Designs (§§ 192-193). "Trellis" Counterpanes (§§ 194-195). Alhambra Fabrics Devoid of Binding Weaves (§ 196). Figured Repp Fabrics (§ 197)

pages 400-412

CHAPTER XV.

PIQUÉ OR TOILET WEFTS: ALSO MATELASSE FABRICS.

Varieties and Characteristic Features of Piqué or Toilet Wefts (§ 198). Methods of Embellishing Piqué Fabrics (§ 199). The Structure of Piqué Fabrics (§ 200). Plain Piqué Fabrics (§§ 201-203). Backed Piqué Fabrics (§ 204). Decorative Effects in Piqué Fabrics (§ 205). The "Float" Harness Mounting (§ 206). Method of Preparing an Applied Design for a "Float" Harness (§ 207). Piqué Fabrics with Net Leno Stripes (§ 208). Data Relating to the Manufacture of Piqué Fabrics (§ 209). **Matelasse Fabrics** and their Characteristic Features (§ 210). The Development of Applied Designs for Matelasse Fabrics (§ 211)

pages 413-445

CHAPTER XVI.

TOILET QUILTING FABRICS.

Distinctive Features and Modifications of Toilet Quilting Fabrics (§§ 212-215). "Dandy" Toileting (§ 216). "Run-up" Toileting (§ 217). Varieties of Toilet Fabrics (§ 218). Jacquard Harness for Toilet Quilting Fabrics (§ 219). Two-pick, One-Shuttle Toilet Quilting (§ 220). Three-pick Toilet Quilting (§ 221). Essential Equipment of a Loom for Weaving the "Half-fast" or "Stocking-back" and "Fast-back" Varieties of Toilet Quilting Fabrics; also a Method of Operating the Comber-boards (§ 222). Four-pick Toilet Quilting and its Various Modifications (§ 223). Five-pick Toilet Quilting (§ 224). Six-pick Toilet Quilting (§ 225). The Additional Embellishment of Toilet Quilting Fabrics by means of Extra Coloured Warp Threads (§ 226). Preparation of Applied Toilet Quilting Designs (§§ 227-228). Data Relating to Ten Examples of Toilet Quilting Fabrics (§ 229)

pages 446-473

CHAPTER XVII.

PATENT SATIN OR MITCHELINE FABRICS.

Origin and Essential Features of the "Patent Satin" Type of Fabric (§ 230). Essential Equipment of a Patent Satin Loom: also the

Construction of the Jacquard Harness; the Method of Drawing-in the Warp Threads; and the Shedding Plan for Patent Satin Fabric (§ 231). A Modified Structure of the Patent Satin Fabric (§ 232). Method of Preparing an Applied Patent Satin Design (§ 233). Data Relating to the Manufacture of Ten Examples of Patent Satin Fabrics (§ 234)

pages 474-480

CHAPTER XVIII.

TAPESTRY FABRICS: ALSO KIDDERMINSTER OR SCOTCH CARPET FABRICS.

Varieties of Tapestry Fabrics (§§ 235-236). Tapestry Fabrics with One Series of Warp and Two Series of Weft, with All-weft Surfaces (§ 237). Tapestry Fabrics with Two Warps and One Series of Weft, with All-warp Surfaces (§ 238). Tapestry Fabrics with Two Series Each of Warp and Weft Threads (§ 239). Construction of a Jacquard Harness for Tapestry Fabrics (§ 240). Method of Preparing Tapestry Designs (§ 241). Instructions for Card Cutting (§ 242). Data Relating to the Construction of Two Examples of Tapestry Fabrics of Coarse and Fine Textures respectively (§ 243). **Kidderminster or Scotch Carpet Fabrics** (§ 244). Drafting and Shedding Plans for Producing Scotch Carpet Fabrics (§ 245). Special Type of Jacquard Machine and Harness Employed for Weaving Scotch Carpet Fabrics (§ 246). Operation of the Jacquard Machine and Harness in a Scotch Carpet Loom (§ 247)

pages 481-501

CHAPTER XIX.

THE DECORATIVE VALUE OF ARTIFICIAL SILK IN TEXTILE FABRICS.

Characteristic Properties of Artificial Silk; also, Its Special Function in the Weaving Industry (§§ 248-251). Illustrations of Fifteen Typical Examples of Fabrics Embellished with Artificial Silk; and Technical Data Relating to Their Construction and Manufacture, viz.: 1, Blouse, Dress, and Shirting Material (§ 252); 2, Blouse and Dress Material (§ 253); 3, Blouse and Dress Fabric of Light Voile Texture (§ 254); 4, Simple Dobby Stripe Figuring (§ 255); 5, Figured Check Fabric (§ 256); 6, Warp Stripe Jacquard Brocade Figuring (§ 257); 7, Jacquard Brocade Figuring on a Voile Texture (§ 258); 8, Warp Ondulé in conjunction with "Net Leno" Effect (§ 259); 9, Light-Texture Dress Fabric of the "Double-Plain" Weave (§ 260); 10, Dobby Stripe Figuring with Warp of "Fancy-Twisted" Yarn (§ 261); 11, Cotton Crêpe-Voile Dress Fabric of very Light Texture, with Extra-Warp Figuring (§ 262); 12, Chenille-Voile Dress Fabric, and Method of Preparing the Design (§ 263); 13, Check Effect Developed by "Fancy-Twisted" Threads (§ 264); 14, French Tapestry Upholstering Fabric of Light Texture (§ 265); 15, Upholstering Fabric of Medium Texture of the "Double-Plain" Weave (§ 266); Chief Types and Varieties of Artificial Silk and Their Reaction with Dyes (§§ 267-268); Multi-Colour Effects Produced by Cross-Dyeing (§ 269); The Production of Three-Colour Effects in Fabrics containing Acetyl-Cellulose (§§ 270-271); Comparison of the Physical Properties of Natural and Artificial Silk (§§ 272-286); Artificial Silk Staple Fibres (§ 287)

pages 502-539

INDEX pages 541-553

CHAPTER I.

INTRODUCTION.

GENERAL PRINCIPLE OF FABRIC STRUCTURE AND THE USE OF DESIGN PAPER.

§ 1. All woven fabrics are composed of at least two distinct series of threads termed "warp" and "weft" respectively. Warp threads lie lengthwise of the fabric, parallel with the selvages (self edges), and weft threads, also termed "picks" of weft, traverse at right angles to warp threads. During the operation of weaving, warp threads are withdrawn simultaneously from their source as a continuous sheet or layer of evenly distributed threads that are spread out to the required width of cloth; whereas weft is (with exceptional instances) inserted only one thread or "pick" at a time, by means of a shuttle which places a continuous thread in successive parallel lengths, extending across the entire width of cloth between the selvages, around which the weft returns for each successive "pick".

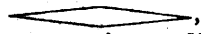
§ 2. The interlacement of warp and weft threads is effected by dividing or separating (in a prearranged order for each pick of weft) the sheet of warp threads into two separate and distinct layers, one above the other (seen thus , when viewed from the end of a loom) to form an opening or division termed a "warp shed". A shuttle, carrying a supply of weft in the form of a "cop," or on a bobbin or quill, is then projected through the "warp shed" to leave a trail of weft between the two layers of warp threads. These subsequently close upon the "pick" of weft which is "beaten up" or pushed by the reed to its ultimate place in the fabric, of which it becomes an integral part. Successive picks of weft are similarly inserted in successive "warp sheds" of different formation produced by

separating warp threads in different orders, and according to a prearranged scheme of interweaving warp and weft, as represented by the design. After each pick is inserted, it is beaten up to its appointed place close to its predecessors, and thus is a textile fabric evolved in accordance with some definite scheme or plan of interweaving which constitutes the structural or woven design.

§ 3. This mode of interlacing two distinct series of threads constitutes the chief and essential principle governing the construction of every type and variety of woven fabrics irrespective of the special division to which they belong. The particular order or scheme of interweaving those threads constitutes a minor principle of fabric structure that becomes the distinctive and characteristic feature of the class of fabrics embodying it. It is the diversity of schemes of interweaving warp and weft that gives rise to an almost infinite variety of textile fabrics, an exact classification of which would be an extremely difficult, if not impossible, task. This difficulty is greater from the circumstance of many fabrics being each known by a variety of trade names not only in different parts of the same country, but even in the same locality.

Under these circumstances the value of such a classification would be nullified, inasmuch as it could not be of general application; otherwise it would greatly facilitate reference by employing a definite term to signify a particular type or variety of fabric. All these varieties, however, may be classified under comparatively few chief divisions, each representing distinct types of fabrics known by technical descriptions and names more or less universally recognised. Each type is characterised by some special constructive element which distinguishes it from other types, and, as a rule, specially adapts it for particular uses. The present treatise is devoted to describing the characteristics of the principal types of fabrics and of their chief varieties and modifications; also the principles governing their construction, and the preparation of designs for them; the chief purposes for which they are employed, and other helpful information of a practical character relating to their manufacture.

§ 4. Textile design is of two kinds, namely (1) structural, and (2) decorative. The first relates to the specific manner in which warp and weft threads are interlaced, by which is evolved *woven design*, which constitutes the technique of fabric structure. The second relates to the scheme of ornamentation by which a textile fabric is decorated, which is also more or less dependent upon woven design. It is the chief object of this book, however, to demonstrate the fundamental principles of structural or woven design, which may be aptly described as the "Grammar of Textile Design".

A textile fabric may contain only one element of woven design and yet be profusely embellished without having recourse to colour. Many white and grey linen and cotton, and also white silk, damask, and brocade fabrics, are good examples of that class. The construction of such fabrics, and of damasks in particular, is frequently based upon some simple elementary weave which is simply reversed to develop the figure and ground portions, thereby causing warp to preponderate on the surface in some parts, and weft in others; hence the contrasting tones of light which enable the figure and ground portions to be distinguished. The most elaborately decorated fabrics will oftentimes be found to contain not more than three or four different varieties of simple weaves effectively introduced in the scheme of decoration; whilst most fabrics employed for domestic purposes, and many others, contain but one element of design of a simple character and specially suited for a specific purpose. An examination of such fabrics will show that warp and weft are interwoven in some simple definite order or sequence that occurs with perfect regularity throughout the entire fabric.

Excepting by the employment of colour, it would frequently be impossible to clearly distinguish the various forms and details of an elaborate design, were it not that a designer has at his command an almost unlimited choice of fundamental weaves by which he may develop its various parts to obtain contrast and variety of effect. Hence, it is equally if not more important that a textile designer should be conversant with the principles of fabric structure, as that he should be an artist and expert draughtsman.

It is important to observe that in all examples of designs contained in this book, filled and shaded squares, or other symbols, on design or point paper, signify that warp threads are raised *over weft*, wherever those marks are placed, and blank squares signify weft passing over warp. This observation is made in consequence of some writers adopting the reverse practice of indicating warp and weft by blank and filled squares, respectively. But it is quite immaterial whichever method is adopted, so long as it is specified

Use of Design Paper.

§ 5. It is also expedient, at this stage, to explain the use of squared paper on which textile designs are prepared. This is ruled with two sets of lines crossing at right angles to form a series of rectangular spaces. At *regular intervals apart* thicker lines, called "bar lines," are ruled in both directions to form large squares termed "bars". These large squares, or "bars," enclose a number of smaller rectangular spaces which may be either in equal numbers in both directions, or there may be more or less divisions in either direction, uniformly, according to the ratio of warp threads and picks per inch in cloth. In one direction, however, the thicker lines are ruled at regular intervals of either eight or else twelve spaces, according to the established practice in the construction of Jacquard machines, in which needles and hooks are (with exceptions) arranged in rows of either eight or else twelve. The thicker lines also incidentally facilitate the counting of spaces when setting out a Jacquard design; and they also serve as an index or guide to a card-cutter, as he "reads off" a design and records it by punching holes in the pattern cards. For the present purpose, however, it is sufficient to state that, excepting when employed for designs for certain compound fabrics, the narrow divisions on design paper correspond, in one direction, to warp threads, and in the other direction to picks of weft. If the number of spaces between two bar lines are alike in both directions, as 8×8 or 12×12 , either series of divisions may represent either series of threads; but if the number of divisions are not alike each way, those of which there are either eight or twelve spaces in a

"bar" must represent warp threads, according to the index of the Jacquard machine for which the design is intended. The ratio of warp and weft spaces in a bar should, however, correspond as nearly as practicable to the ratio of warp threads and picks per inch in the *finished fabric*, in order to ensure the correct shape of figures in a pattern. For example, if a design is to be prepared for a fabric that will contain eighty warp threads and sixty picks per inch, to be produced by means of a 400's Jacquard machine, the proper counts of design paper for it is that ruled 8×6 divisions to each "bar": and for a 600's Jacquard machine, that ruled 12×9 is the proper counts. By placing a dot in a small square, it signifies that the corresponding warp thread must be raised above the corresponding pick of weft in cloth; and a blank square signifies that weft must pass over warp at the parts indicated.

CHAPTER II.

THE PLAIN OR CALICO WEAVE AND ITS MODIFICATIONS.

§ 6. The "plain," "calico" or "tabby" weave, as it is variously described, is the most simple and elementary combination of two series of threads employed in the construction of textile fabrics; albeit, it produces a relatively stronger fabric than is obtained by any other simple combination of threads, excepting that of "gauze" or "cross-weaving".

The minor principle observed in the construction of plain cloth is the interlacement of any two contiguous threads of either warp or weft in an exactly contrary manner to each other, with every thread in each series passing alternately under and over consecutive threads of the other series uniformly throughout the fabric. By this plan of interlacement, every thread in each series interweaves with every thread in the other series to the uttermost extent, thereby producing a comparatively firm and strong texture of cloth. Also, a complete unit of the plain weave occupies only two warp threads and two picks of weft, as represented in Fig. 1, which is the design (as indicated on design paper) for that weave. The rectangle enclosing two shaded and two white squares indicates one unit of the design, which is repeated sixteen times. The construction of plain cloth is clearly demonstrated by means of Figs. 2, 2A and 2B, which are diagrams representing a plan, a transverse section (crosswise), and a longitudinal section (lengthwise) respectively of that cloth.

Firmness of Texture.

§ 7. The degree of firmness of texture in woven fabrics is largely determined by the manner of interweaving warp and weft, and will be greater or less according as the two series

of threads interlace more frequently or less frequently, respectively. Thus, if two pieces of cloth are woven from similar warp and weft, and with the same number of warp threads and picks per inch—(a) with the plain weave, in which all threads interlace to the uttermost extent, and (b) with any other weave—the latter would be less firm, and therefore of weaker texture than the former, because the threads composing it would be bent in a lesser degree than those of the plain weave, thereby causing them to be less firmly compacted. For this reason it is important that the counts of warp and weft, the number of warp threads and picks per inch, and the weave, should be properly proportioned, in order to obtain the best results. This

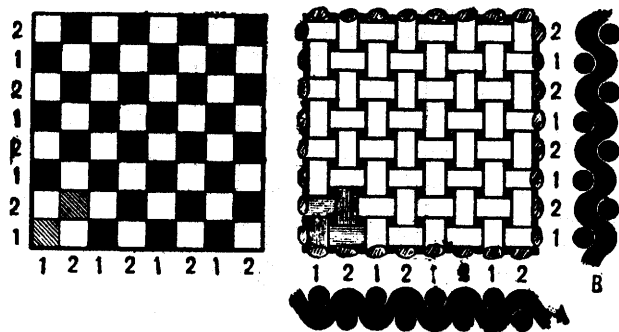

FIG. 1.—Plain or tabby weave. FIG. 2.—Plan and sections of the tabby weave.

phase of fabric structure, however, does not come within the scope of this treatise.

Notwithstanding the very simple character of the plain weave, it is produced in a great variety of forms and textures, possessing totally different characteristics, which adapt it for specific purposes. Apart from those arising from the employment of different textile materials, and also without in any way departing from the true principle of the plain weave, as defined in § 6, the varieties of texture and form are produced (a) by the employment of different counts of yarn for different fabrics; (b) by the employment of warp of one counts and weft of another counts in the same fabric; (c) by the employment of warp or weft, or both warp and weft, of different counts in the same

fabric; and (d) by subjecting some warp threads to a greater degree of tension than others during weaving.

Variety of Texture.

§ 8. The term "texture" is here used to signify the general qualities of a fabric as regards material, counts of yarn, relative density of threads, weight, bulk, how it feels when handled,

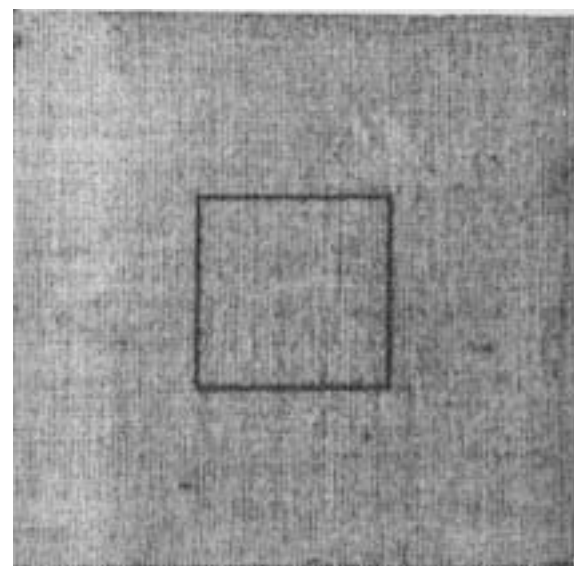

FIG. 3.—Plain calico cloth.

and other properties peculiar to woven fabrics. Plain cloth is produced in a greater variety of textures than perhaps any other weave, and varies from the fine, light, open and airy texture of muslin, to that of coarse and heavy hempen sackcloth. When produced from cotton yarn of counts ranging in different fabrics from about 20's to 160's for both warp and weft, and containing from about 40 to 160 warp threads and picks per inch, it is known as *calico*—a fabric produced in great quantities, and extensively used in both a grey (*i.e.*, of the natural colour of

cotton) and a bleached state, for a variety of domestic purposes. A true plain cloth is one in which the counts and qualities of both warp and weft, and also the number of warp threads and picks per inch, are similar. When these conditions exist either precisely or approximately, whether the texture is fine or coarse, light or heavy, it will produce a general evenness of surface, resulting from warp threads and picks each bending or yielding

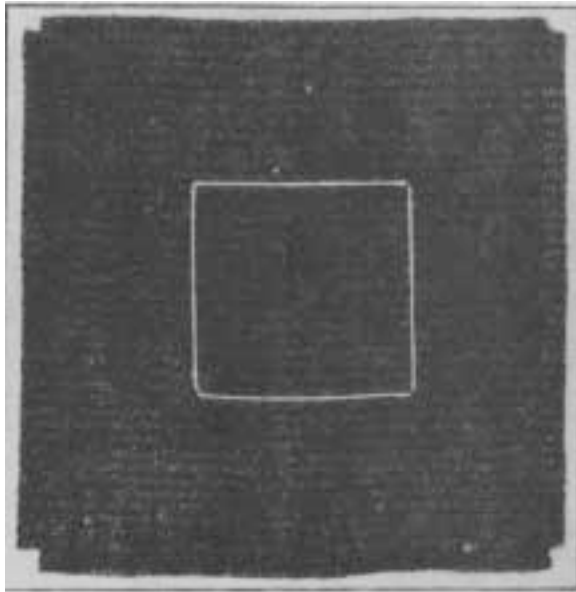

FIG. 4.—Simple warp-ribbed cloth.

to each other's influence in a corresponding degree. Fig. 3 illustrates an example of grey "calico" of medium quality, containing seventy-two warp threads of 36's T., and sixty-two picks of 30's W., per inch. (The rectangle encloses one square inch of cloth.)

Variety of Form : Ribbed Fabrics.

§ 9. The least variation of form in the plain weave is effected by employing warp and weft of sufficient difference of counts

and density of threads to produce a ribbed or corded effect throughout the fabric. The ribs or cords will lie in the direction of the coarsest threads, and will be more or less prominent according as the difference in counts between the two series of threads is greater or less respectively. Fig. 4 illustrates an example of cloth woven from comparatively fine warp and coarse

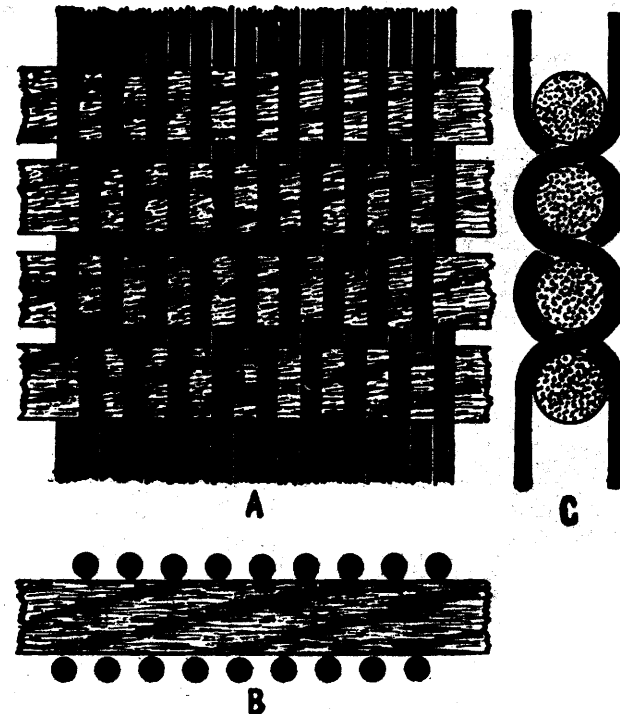

FIG. 5A, B, C.—Plan and sections of simple warp-ribbed cloth.

weft, which develop a series of ribs lying in the direction of weft, and known as *warp* ribs. By reversing these conditions, the ribs would lie in the direction of warp, in which case they would be termed cords, or *weft* ribs. In either case the rib formation is entirely due to the non-yielding quality of the coarser and stronger threads, and the yielding quality of the finer and weaker threads, which perform all the bending under

and over the coarser threads. This is clearly illustrated by diagrams, Figs. 5A, 5B and 5C, which are a plan, transverse section and longitudinal section, respectively, of the warp-ribbed cloth, Fig. 4, which contains sixty-eight warp threads and sixteen picks per inch. (The rectangle encloses one square inch of cloth.)

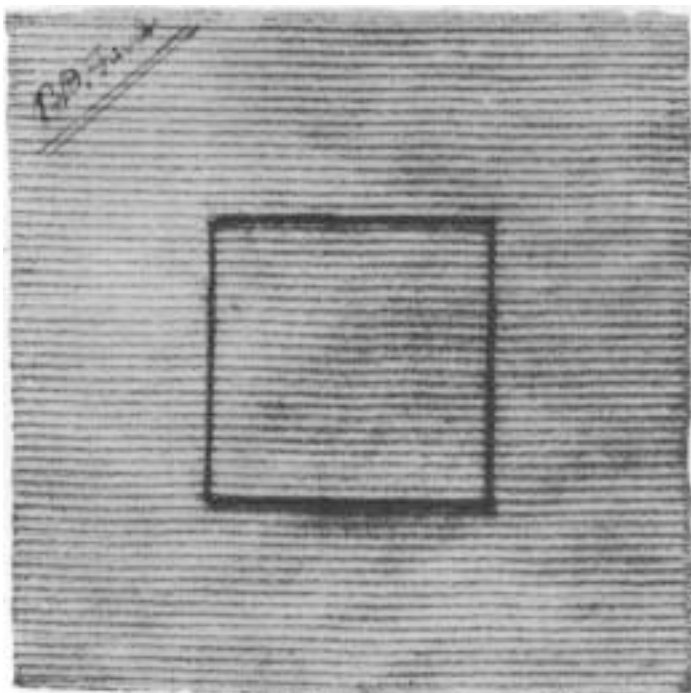

FIG. 6.—A third example of warp-ribbed cloth.

Another variety of the plain weave is illustrated in Fig. 6. In this example the rib formation results not entirely from any great difference between the counts of warp and counts of weft, as in the previous examples, but only partly from that circumstance, and, in a greater measure, in consequence of alternate warp threads being held at a considerably greater degree of tension than intermediate warp threads, during the operation of

weaving. This difference of tension between what are virtually two series of warp threads—although each series is of exactly the same kind of yarn—necessitates the use of two warp beams one containing, say, all odd-numbered warp threads, and the

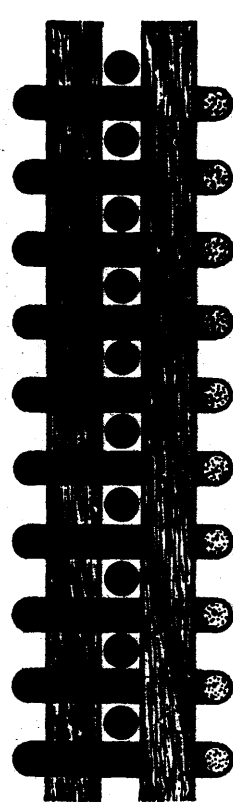

FIG. 6A.—Transverse section of cloth represented by Fig. 6.

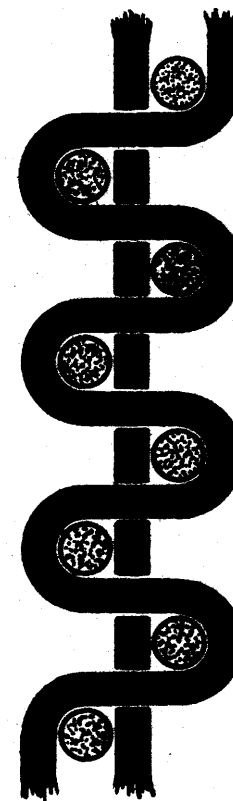

FIG. 6B.—Longitudinal section of cloth represented by Fig. 6.

other all even-numbered warp threads. Only one system of weft, which is of coarser counts and much softer than the warp, is employed. In consequence of some warp threads being held taut during weaving they are prevented from bending, and therefore lie in an almost perfectly straight line throughout the

length of cloth. This causes picks of weft to lie perfectly straight and in two planes, above and below taut warp threads, and so form prominent ribs on both sides of the cloth; whilst slack warp threads freely bend over and under picks of weft, to bind them firmly in position, as indicated in transverse and longitudinal sections, diagrams Figs. 6A and 6B.

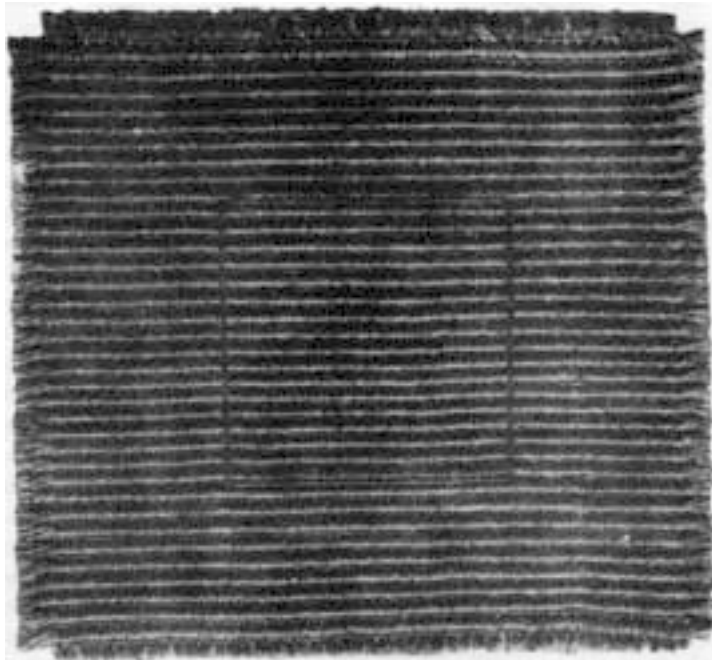

FIG. 7.—Repp (warp-ribbed) cloth.

The amount of contraction of warp during weaving, in cloth of this description, will vary according to the counts of weft and number of picks per inch, as well as according to the degree of tension upon the warp during weaving. The contraction will be greater or less in proportion to the thickness of weft and the number of picks per inch in cloth. In the example, Fig. 6,

which contains eighty-four warp threads of 30's T. and forty-six picks of 16's W. per inch, the amount of contraction is equal to $2\frac{1}{4}$ per cent. for taut, and $33\frac{1}{2}$ per cent. for slack warp threads. (The rectangle encloses one square inch of cloth.)

§ 10. One more variety of ribbed cloth, based on the principle of the plain weave, will serve, along with the two previous examples, to demonstrate its variation of form in the development of ribbed fabrics. This is the well-known "repp" cloth, illustrated in Fig. 7, so extensively employed for window blinds in railway carriages and other vehicles, and for the upholstering of furniture. In general appearance it closely resembles the ribbed cloth illustrated in Fig. 4; but a close inspection of both examples will reveal a great difference in their construction and texture—the repp cloth being much firmer and stronger than the ribbed cloth.

In the production of repp cloth, as illustrated in Fig. 7, two distinct series of both warp and weft threads are employed—the counts and character of each series being such as to develop a series of very prominent and sharply defined ribs in the direction of weft. The warp series comprise two counts of yarn—one fine and strong, which is held at greater tension during weaving, and the other coarse and soft, which is held at a lesser degree of tension, to enable it to easily yield and bend over coarse and under fine picks of weft. Each series of warp threads is wound upon a separate warp beam to allow of a different rate of contraction during weaving. They may be arranged in the harness and reed in the order of one fine and one coarse warp thread alternately; but a superior rib will be produced by running two *medium* warp threads together, as in the example, Fig. 7, and as indicated in plan, Fig. 8A. The weft series also comprise two counts of yarn—one fine and strong, similar to the fine warp, and the other very coarse and strong. These are inserted, one fine and one coarse pick alternately, thereby requiring a loom with two shuttle boxes at each end of the sley, and a "pick-and-pick" picking motion, *i.e.*, one capable of picking twice, or more than twice, in succession, from each side of a loom. When coarse picks are inserted, all medium warp threads only are raised to form ribs; and when fine picks are inserted, all

fine warp threads only are raised, thereby forming deep furrows by binding down all medium warp threads between the coarse picks, as seen in longitudinal section, diagram, Fig. 8B. The sample of repp cloth illustrated in Fig. 7 contains $21 \times 2 = 42$ medium, and 21 fine warp threads per inch; and 17 coarse and 17 fine picks per inch. (The rectangle encloses one square inch of cloth.)

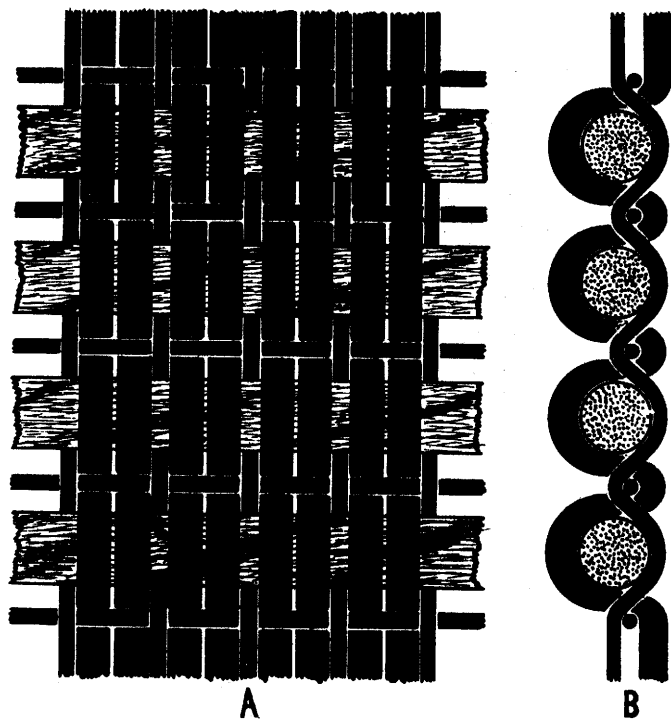

FIG. 8A, B.—Plan and longitudinal section of repp cloth.

§ 11. In the foregoing examples of ribbed fabrics, the ribs of the respective pieces are of uniform size, and occur in immediate succession, thereby producing a general evenness of effect and uniformity of texture throughout the entire piece of cloth. Cords or ribs are, however, frequently employed as a simple means of ornamenting what would otherwise have been

entirely plain fabrics, but which are made to assume a variety of decorative effects of a very pleasing character. Such effects are, of course, confined to stripes, running either up or across the cloth, and to checks. Stripes may be formed in an upward direction in a plain calico fabric by disposing comparatively coarse warp threads or else groups of warp threads either at regular or irregular intervals apart, according to the effect desired. Such threads may be either of uniform counts, to produce plain ribs, or of different counts, to produce variegated ribs. By inserting coarse picks of weft instead of coarse warp threads in the manner just described, stripes would be formed across the piece; and by introducing coarse threads in both series, checks

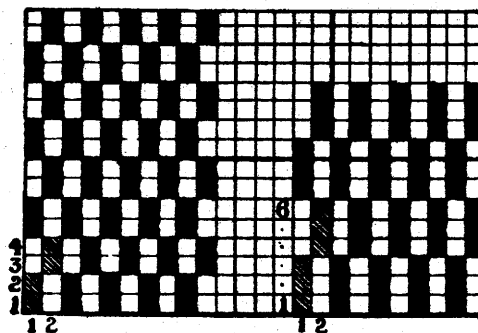

FIG. 9.

FIG. 10.

of great variety may be formed. A familiar example of this method of embellishing a plain fabric is that of a cambric pocket handkerchief, bordered either by a series of thick threads or by placing two or more fine threads together side by side to form cords.

§ 12. The development of ribs and cords is not dependent upon the employment of coarser threads in one series than in the other. They may be formed in fabrics composed of warp and weft of uniform counts, by causing two or more threads of one series (according to the required prominence of rib) to lie closely side by side, so as to virtually constitute a coarse thread composed of several strands not twisted together, and

interweaving such groups of threads with separate threads of the other series. If threads are grouped in uniform quantities throughout, the ribs will be of uniform size; but if grouped in irregular quantities, a series of variegated ribs will be produced.

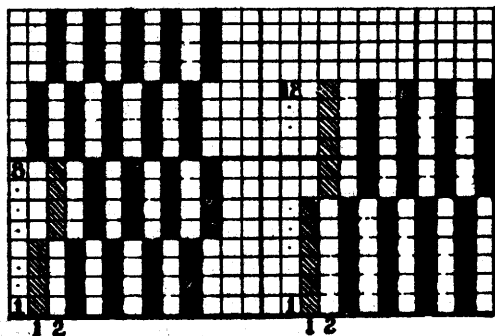

FIG. 11.

FIG. 12.

By this method the rib formation is caused by the combined resistance of the grouped threads, which lie straight, thereby compelling the separate threads of the other series to yield and bend under and over them, in accordance with the principle of fabric structure which determines that the relative

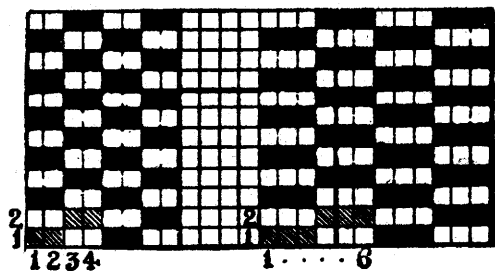

FIG. 13.

FIG. 14.

prominence of threads *diminishes* in proportion to the amount of bending performed by them in cloth.

§ 13. Simple ribs of various sizes may be formed in the direction of weft by separating alternate warp threads (as in the plain calico weave) and inserting two or more picks of weft in the

C

same warp sheds. Figs. 9 to 12 are designs for this class of rib weaves containing two, three, four, and six picks respectively, in each warp shed. Each design repeats on two warp threads, and such number of picks as are contained in two ribs, namely,

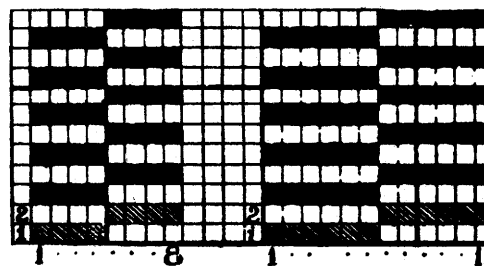

FIG. 15.

FIG. 16.

four, six, eight and twelve respectively. In the production of these or other weaves, in which several successive picks are inserted in the same shed, it is necessary to furnish a loom with a selvedge motion, to operate selvedge warp threads in a different order from that of warp threads forming the body of the fabric,

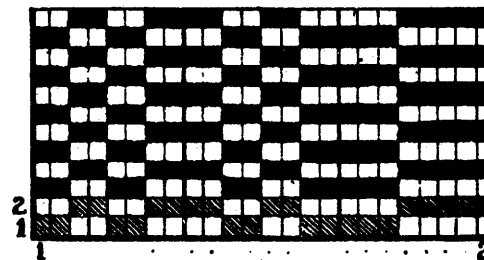

FIG. 17.

and thereby prevent picks of weft from being pulled backward into the shed when a shuttle passes through the same shed for several picks in succession.

§ 14. Simple cords may be formed in the direction of warp by raising warp threads in uniform groups of two or more threads which may pass through heald eyes either separately or in groups. Figs. 13 to 16 are designs for cords in which two,

three, four, and six warp threads respectively are grouped together. Each design repeats on as many warp threads as are contained in two cords, and two picks of weft. Since each pick is contained in a separate warp shed, it is unnecessary to employ a special selvedge motion when weaving those designs.

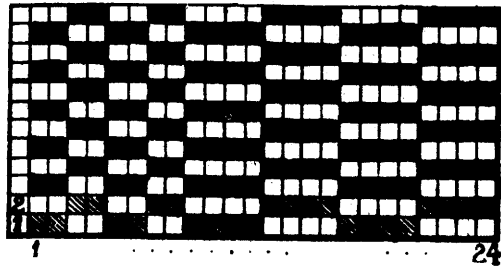

FIG. 18.

It was stated in § 12 that variegated cords or ribs may be formed by an irregular system of grouping threads either warp way or weft way respectively. It should be observed, however, that much greater scope is afforded in this respect by grouping warp threads, than by grouping picks of weft; also that varie-

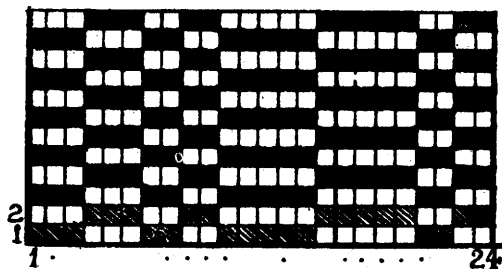

FIG. 19.

gated cords (warp way) may be produced more economically than variegated ribs (weft way). This arises from the fact that cords of any variety may be formed in a plain loom simply by varying the drafting of warp threads through the healds; whereas variegated ribs would require to be woven in a loom mounted with a dobby or even a small Jacquard machine (for large

patterns) and furnished with a selvedge motion. Also, in addition to the extra cost of such looms, the weavers would require to be paid a higher rate of wages. Figs. 17 to 20 are designs for variegated cords, each repeating on twenty-four warp threads

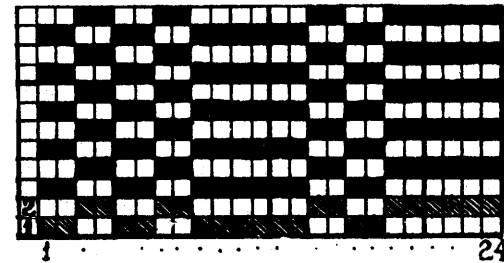

FIG. 20.

and two picks. By turning those designs on their side they become variegated ribs, repeating on two warp threads and twenty-four picks.

Matt Weaves.

§ 15. Simple matt weaves are those in which groups of two or more contiguous warp threads and picks interlace with each

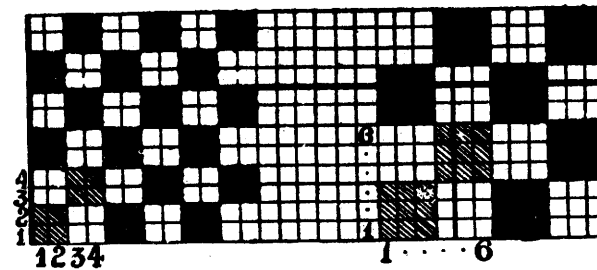

FIG. 21.

FIG. 22.

other so as to produce a chequered or dice effect, as represented in designs, Figs. 21, 22 and 23. The simplest of these weaves is that known as a two-and-two or four-end matt weave, indicated in Fig. 21, in which warp threads and picks interweave in pairs throughout the fabric, on the principle of the plain weave.

This matt weave is extensively adopted for a great variety of fabrics, of which dress materials, shirtings, sailcloth (for ships' sails), and "duck" cloth are, perhaps, the more notable examples. Figs. 22 and 23 are designs for three-and-three (six-

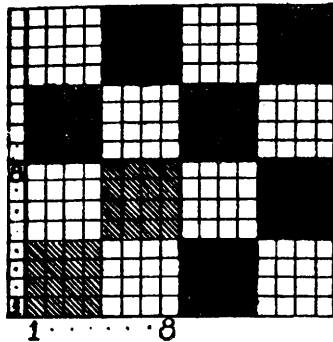

FIG. 23.

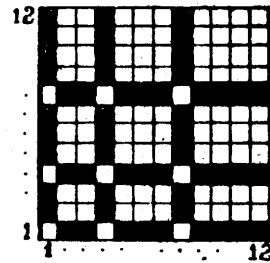

FIG. 24.

end) and four-and-four (eight-end) matt weaves respectively. When these and larger matt weaves are employed, the number of warp threads and picks per inch in cloth should be propor-

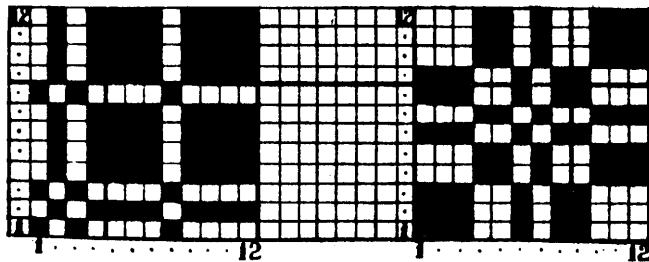

FIG. 25.

FIG. 26.

tionately increased, otherwise they would produce fabrics of an open and flimsy texture, in which the threads would become easily displaced, in consequence of the very few intersections made by them.

§ 16 Variegated matt weaves are developed by combining irregular groups of warp and weft threads, after the manner

indicated in Figs. 24 to 29, of which the first three are designs repeating on twelve, and the last three, on sixteen warp threads and picks. They may be formed with weft preponderating on

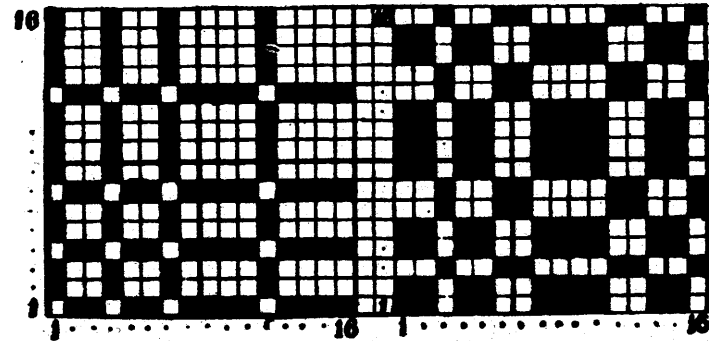

FIG. 27.

FIG. 28.

the face, as Figs. 24 and 27; with warp preponderating on the face, as Figs. 25 and 28; or they may be designed as true counterchange or diaper patterns, as Figs. 26 and 29, in which

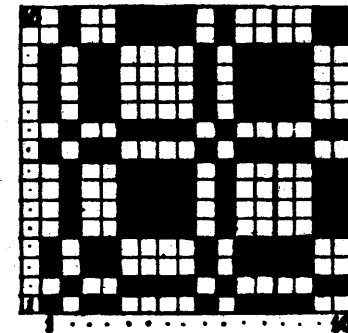

FIG. 29.

warp and weft are exactly counter to each other and in equal quantities on both the face and back of the fabric. It will be observed that in these designs, as in all others of the same class, there are only two orders in which warp threads interweave with

weft, thereby requiring not more than two healds for their production in cloth, although the healds would require to be operated by a dobby or other shedding device, for designs repeating on such number of picks as are beyond the reasonable scope of tappets.

CHAPTER III.

TWILL AND KINDRED WEAVES.

§ 17. Twill weaves form a distinct departure from any of the foregoing, and they constitute a most useful variety of weaves extensively employed in the construction of numerous classes of fabrics. They exist in endless varieties of form, and are based on a simple principle of design; but whatever particular appearance they assume, they are generally characterised by a series of more or less pronounced diagonal wales or ridges and furrows, with either warp or weft preponderating, or in equal quantities, on the face of the fabric. The twill may be produced continuously either from right to left (*i.e.*, *sinistrally*), as in Fig. 30; or from left to right (*i.e.*, *dextrally*); or again, it may be produced in reverse directions in the same fabric, as desired. The variety of twill weaves is so considerable as to render an exact classification of them impossible. For the present purpose, however, they may be broadly divided into six chief varieties, namely: (1) continuous twills; (2) zigzag or wavy twills; (3) rearranged twills, including satin weaves and "corkscrew" twills; (4) combined twills; (5) broken twills; (6) figured and other twill weaves of an indefinable character. Each of these divisions may be subdivided into (*a*) warp-face twills; (*b*) weft-face twills; and (*c*) warp and weft-face twills, in which warp and weft are in either equal or unequal quantities on the face of the fabric.

1. Continuous Twills.

§ 18. (*a*) *Warp-face Twills*.—These are formed by raising all warp threads, excepting one, in each repeat of the pattern, for each pick, and stepping one warp thread in consecutive rotation (to the right or left, according to the required direction of twill)

as successive picks are inserted. These will develop a series of diagonal wales or ridges of warp, separated by furrows formed by single stitches of weft. Twill weaves may be formed on any number of warp threads and picks, from three upwards. Figs.

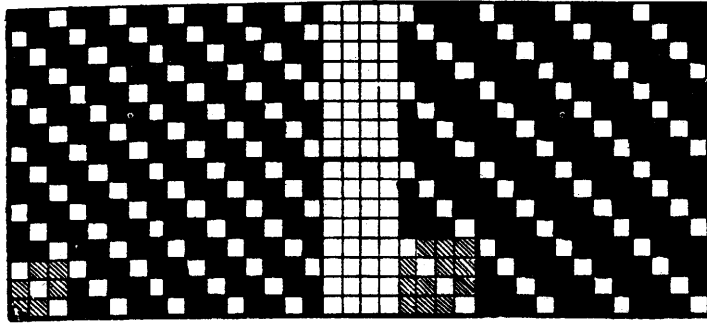

FIG. 30.

FIG. 31.

30 to 35 are designs for warp twills repeating on three to eight warp threads and picks respectively, and will be sufficient to indicate the principle of their construction.

§ 19. (b) *Weft-face Twills*.—These are produced by reversing

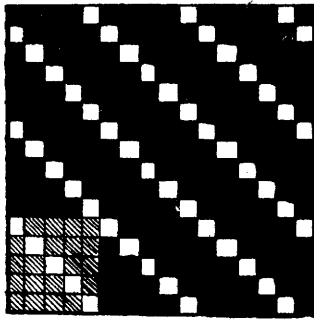

FIG. 32.

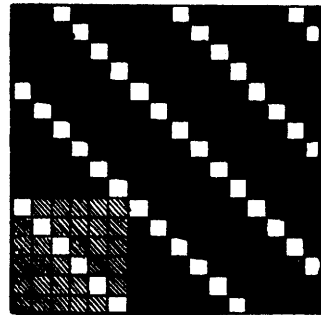

FIG. 33.

the conditions stated in § 18, by raising one warp thread only, in each repeat of the pattern, for each pick, and proceeding in a similar manner to that described for warp-face twills. This will produce a series of diagonal ridges of weft separated by single stitches of warp, as indicated in designs, Figs. 36 to 41, which

are for weft twills repeating on three to eight warp threads and picks respectively.

§ 20. (c) *Warp and Weft-face Twills*.—These may be formed with either equal or unequal wales of warp and weft arranged

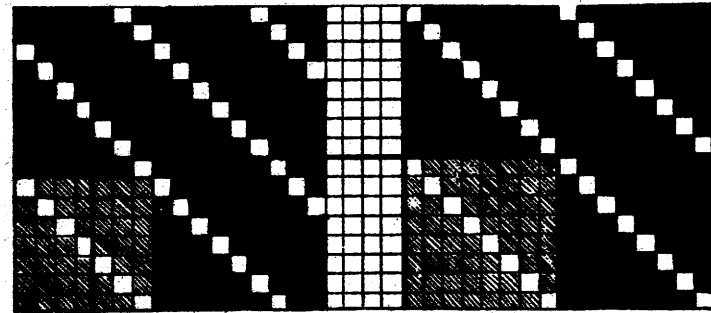

FIG. 34.

FIG. 35.

alternately. If the wales are equal, that is, if both warp threads and picks pass over and under the same number of threads uniformly, warp and weft will necessarily be in equal quantities on both the face and back of the fabric; but if the wales are

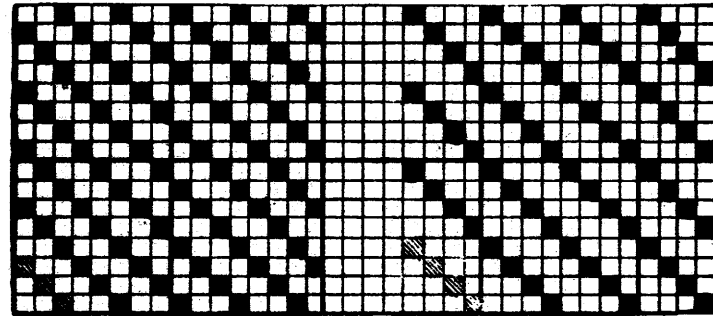

FIG. 36.

FIG. 37.

unequal, warp and weft may be either in equal or unequal quantities on the face and back of cloth. Equal wales are formed by alternately raising and leaving down equal groups of two or more warp threads for each pick, and stepping one warp

thread in consecutive rotation as successive picks are inserted. The least of this class is that variously known as the "two-and-two" ($\frac{2}{2}$), the "Harvard" and the "Cassimere" twill given in Fig. 42, which repeats on four warp threads and picks. This is

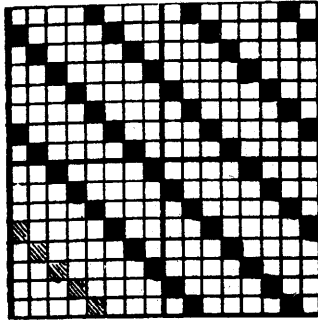

FIG. 38.

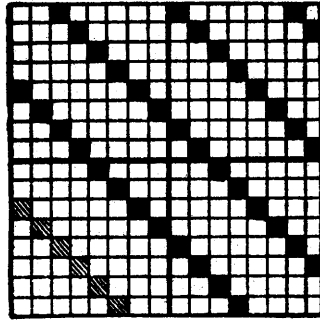

FIG. 39.

a very useful weave, and one that is perhaps more extensively employed than any other of its class. The principle on which it is constructed is conducive to the production of firm and strong cloth of comparatively light texture. These qualities

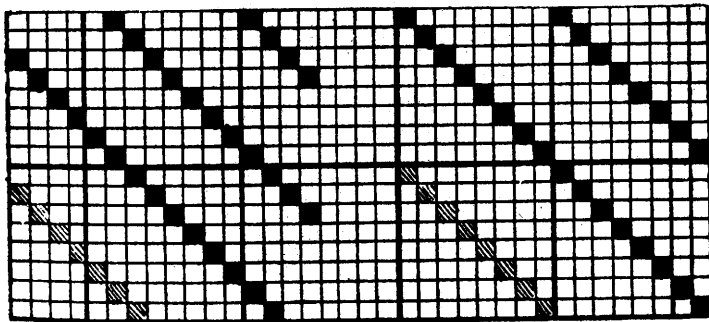

FIG. 40.

FIG. 41.

arise from warp and weft interlacing with such frequency and in such a manner as to permit of the threads of each series lying close together. On examining this weave, it will be seen that alternate threads of warp or weft interweave in an opposite

manner at the same time; that is, when one is above, the other is below the same threads of the other series, although all threads in both series interweave in a precisely similar manner to each other. For these reasons, this simple twill weave is

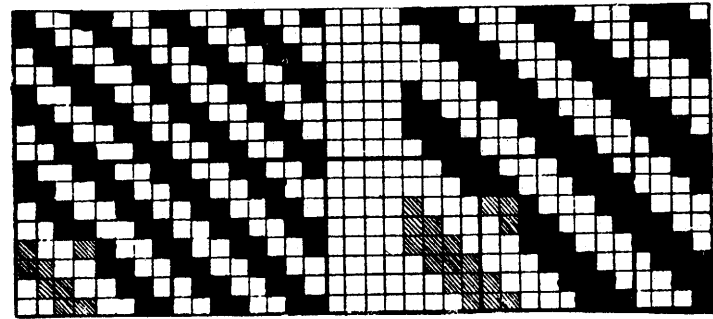

FIG. 42.

FIG. 43.

capable of producing a firm, close and compact texture, and is one of the most useful weaves to a textile designer. Figs. 43 and 44 are two other examples of twill weaves having warp and weft in equal quantities on both the face and back of cloth.

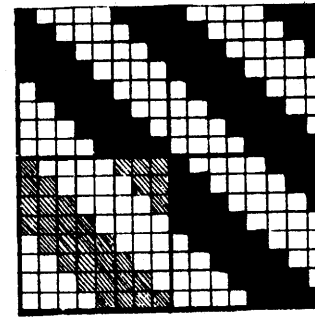

FIG. 44.

Fig. 43 is a six-end ($\frac{3}{3}$) twill, and Fig. 44 an eight-end ($\frac{4}{4}$) twill. It will be observed in Fig. 43 that the first and fourth threads in either series, counting from any thread, interweave in an opposite manner to each other at the same time. Like-

wise with the first and fifth threads in Fig. 44. Knowledge of these features is valuable to a designer in the development of broken twills, and other designs having a twill foundation.

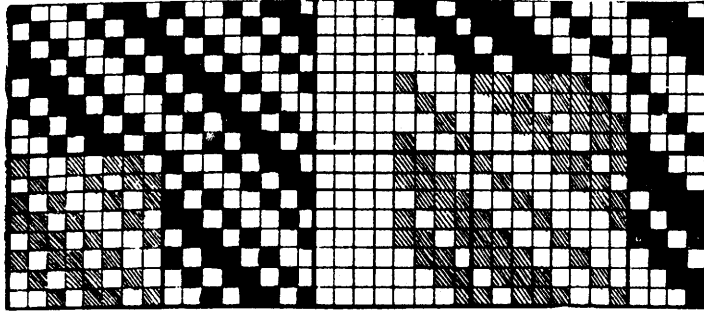

FIG. 45.

FIG. 46.

Figs. 45, 46 and 47 are designs for twill weaves to produce unequal wales of warp and weft in equal quantities on both face and back; whilst Figs. 48, 49 and 50 are designs for twills

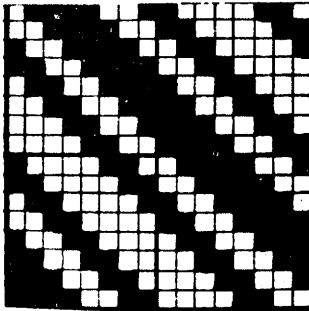

FIG. 47.

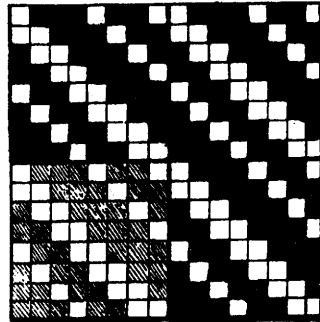

FIG. 48.

having unequal wales of warp and weft, but with warp preponderating on the face. The three designs of each of these latter varieties repeat on eight, twelve and sixteen warp threads and picks respectively.

Before proceeding to describe the second class of twill weaves, as enumerated in § 17, it will be both interesting and instructive

to indicate the main influences affecting the angle, and also the relative prominence, of twills in cloth.

The Angle of Twill.

§ 21. The angle of twill in any continuous twill weave in which the progression is accomplished by advancing one thread

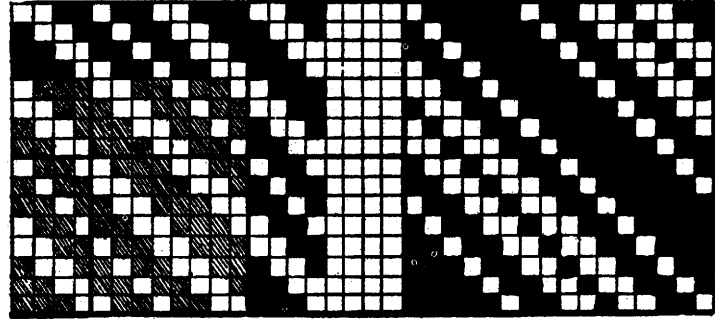

FIG. 49.

FIG. 50.

only at a time, with both warp and weft is determined by the ratio existing between the number of warp threads and picks in a given measurement, say, one inch. If warp threads and picks

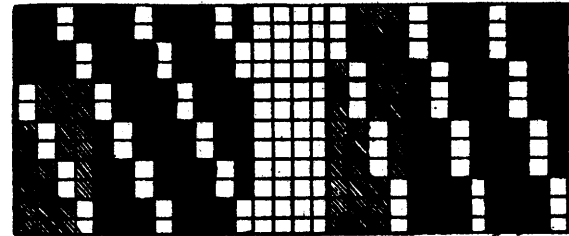

FIG. 51.

FIG. 52.

are in equal numbers per inch, the angle of twill must necessarily be one of forty-five degrees, irrespective of any difference that may exist between the counts of warp and weft; but if the threads of one series are more numerous than those of the other, the angle of twill will assume an inclination towards those threads

in greater number. Thus, if there are more warp threads than picks per inch, the angle of twill will incline in the direction of warp threads in proportion to the excess of warp threads over picks; but if there are more picks than warp threads per inch, the angle of twill will incline more in the direction of weft. High-angle or low-angle twills may also be formed by advancing two or more threads together in one series, and one thread only in the other series, as in Figs. 51 to 54. If a *high-angle* twill is produced by this method, or if warp threads exceed picks per inch, the twill should be developed with warp, as in Figs. 51 and 52. If a *low-angle* twill is required, or if picks exceed

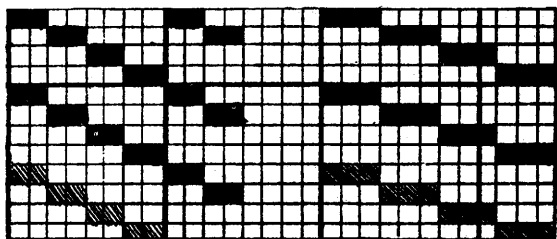

FIG. 53.

FIG. 54.

warp threads per inch, the twill should be developed with weft, as in Figs. 53 and 54.

Influences Affecting the Prominence of Twills and Kindred Weaves.

§ 22. A twill weave will assume either a more or a less pronounced character in cloth, according to different circumstances. The relative prominence of twills is chiefly determined by (a) the character of weave; (b) the character of yarn; (c) the number of warp threads and picks per inch; and (d) the direction of twill in relation to the direction of twist imparted to yarn during spinning.

(a) *Character of Weave.*—A twill weave will be relatively more pronounced if developed from longer than from shorter floats of yarn; but unless the freer interlacement of threads is counterbalanced by a proportionate increase in their number per

inch, the fabric will be relatively weaker, for reasons stated in § 7. It is to obtain longer floats of yarn that high-angle twills should be developed with warp, and low-angle twills with weft, as explained in § 21. If those conditions were reversed, the twill would lack fulness owing to the short flushes of yarn, as may be readily observed on examining the reversed side of a fabric of this class.

(b) *Character of Yarn.*—A more pronounced twill will result either from coarse-spun or soft-spun yarn than from fine-spun or hard-spun yarn; also from folded yarn (*i.e.*, a thread consisting of two or more single strands of yarn twisted together) than from single yarn.

(c) *Number of Threads per Inch.*—A twill will be relatively more or less pronounced in proportion to the number of warp threads and picks of weft per inch.

(d) *Direction of Twill in Relation to the Direction of Twist in Yarn.*—If the same twill weave is produced to the left in one fabric, and to the right in another fabric of exactly similar texture, and woven from similar yarn, or (which amounts to the same) if the same twill is produced in both directions in different parts of the same fabric, it will appear to be more pronounced in one direction than in the other, according to the direction of twill in relation to the direction of twist in the yarn composing it. This difference is also observable between the obverse and reverse sides of the same fabric, especially if warp and weft are in equal or in nearly equal quantities on both sides. For example, if a twill inclines to the left (thus \backslash) when viewed obversely, it will incline to the right (thus $/$) when viewed on the reverse side, albeit the direction of twist in both warp and weft remains the same. Therefore the direction of twill in relation to the direction of yarn twist is different on each side of the fabric, with the result that the twill appears to be more prominent on one side than on the other. In this case, however, the influence exerted by the deflection of the warp line out of a straight course between the breast beam and back rest of a loom (to spread the warp threads and thereby obtain what is termed "cover" in cloth) will be a contributory factor affecting the relative prominence of twill on both sides of a fabric. This

circumstance, however, does not entirely account for the difference between the obverse and reverse sides of a twill cloth, otherwise no difference would be manifest between the same twill produced to the right and to the left in different parts of the same fabric.

What actually occurs, is that the series of ridges and furrows in a twill fabric are *more sharply defined* and pronounced if they incline in the *opposite* direction to the twist in yarn with which the *ridges* of twill are formed; and *per contra*, the twill will be *less prominent* if the twill and yarn twist lie in the *same* direction.

§ 23. This peculiar and interesting phenomenon in twill and allied weaves has engaged the attention of several textile experts who have sought to discover the cause; and although various theories have been suggested as probable explanations of its true cause, this is still a matter for conjecture, and cannot, therefore be stated positively.

According to one theory this phenomenon is attributed to the effect produced by the reflection of light at different angles from the fibres composing the threads, according to the direction in which the fibres lie in relation to the direction of twill. This may partly account for the different effects, but it is apparently not the chief factor, as may be easily demonstrated by taking a piece of cloth in which the same twill is produced in both directions, in different parts, and viewing it in a neutral or well-diffused light, when a decided difference will be observed between the twill inclined to the right, and that inclined to the left. The twill in the opposite direction to the twist of yarn will be more distinct than that in the same direction as yarn twist. It would appear, therefore, that the difference is caused either partly or entirely by some influence exerted by the direction of twill upon the twist of yarn. This preconception forms the essence of another theory based on the assumption that since the spirality of a spun thread is artificial, and not a natural feature of such a thread, the fibres composing it subsequently tend, under favourable conditions, to recover their original straight and free condition, thereby causing the thread to untwist, especially when it is subjected to tensile strain. Hence

D

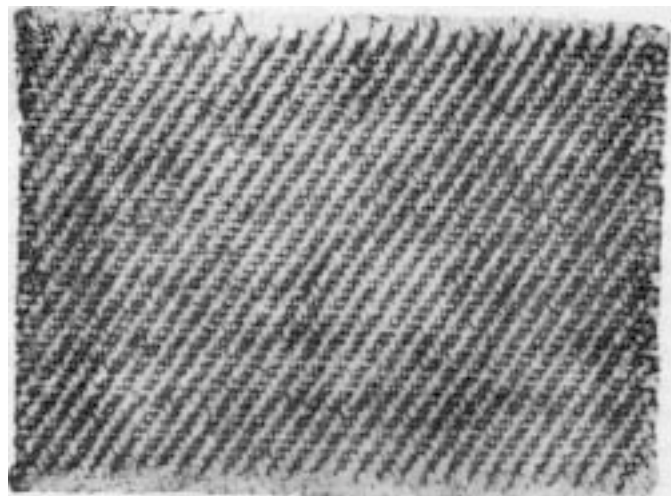

FIG. 55.—Showing the obverse side of $\frac{2}{2}$ twill cloth of coarse texture, produced from folded warp and weft twisted sinistrally, or weft-way (when folded), and with the twill produced upward from left to right, or dextrally. (Note the prominence of twill.)

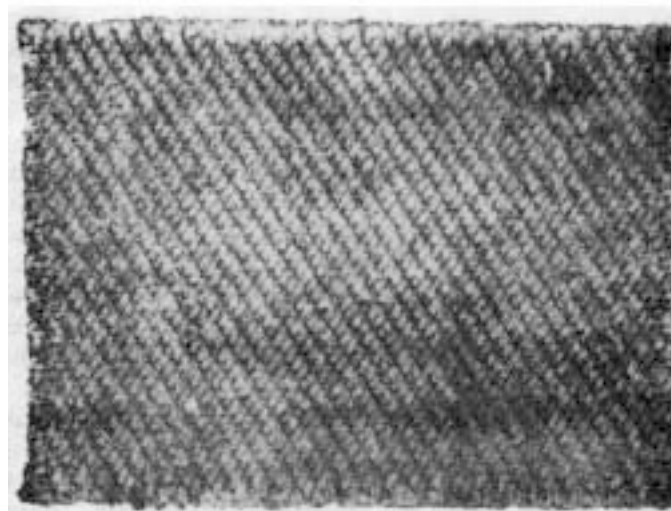

FIG. 56.—Showing the reverse side of the piece of twill cloth represented in Fig. 55. (Note the peculiar inclination of warp threads from a straight course, and its effect in subduing the twill.)

it is suggested that, during weaving, when the respective threads are under tension, they tend to untwist in cloth, and consequently roll slightly out of their original perfectly straight course, and assume a more or less oblique inclination between the points where they intersect with other threads, unless some means are adopted to prevent or check such tendency by producing the twill in the *reverse* direction to that of the yarn twist.

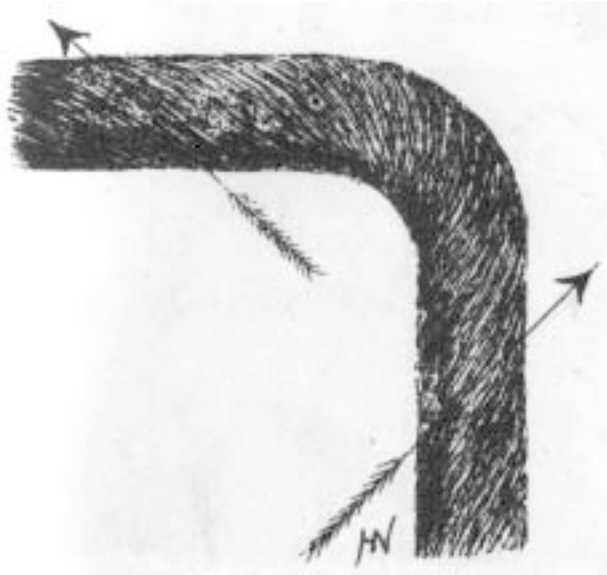

FIG. 57.—Showing a thread spun with a right-hand twist, or “twist-way”.

§ 24. The different effects of the same twill weave produced in reverse directions in the same fabric are exemplified in a very striking manner by Figs. 55 and 56, which represent portions of the obverse and reverse sides respectively, of an actual example of grey cotton two-and-two twill cloth, containing thirty-five warp threads per inch of 4/8's yarn; and twenty-two picks per inch of 4/10's yarn. The single strands of yarn composing the folded threads of both warp and weft are spun “twist” way, *i.e.*, *dextrally*, with the twist or spirality extending upward

from left to right, thus / (when the thread is viewed either suspended vertically, or extending away from the observer) and as indicated in Fig. 57; but the doubling twist of the folded thread is in the reverse direction to that of the single-yarn twist (in accordance with usual practice in doubling spinning), namely, “weft” way, *i.e.*, *sinistrally*, with the twist inclining from right

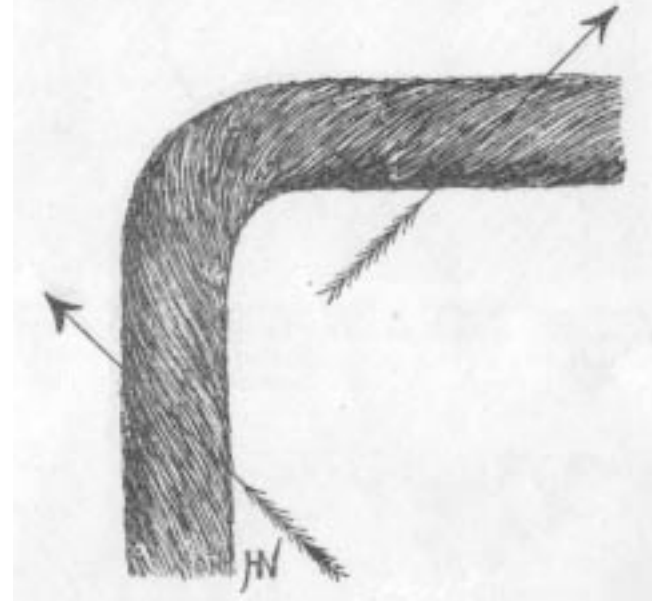

FIG. 58.—Thread spun with left-hand twist, or “weft-way”. (Right-hand—American style.)

to left, as indicated in Fig. 58. The twill on the obverse or face side of cloth inclines to the right, and therefore *opposes* the direction of twist in the warp threads, which are both coarser and more numerous than picks of weft, and are consequently more pronounced than these. Hence, the twill is much more prominent on the obverse than on the reverse side of the cloth, where it inclines in the *same* direction as the warp twist.

§ 25. According to the second theory explained in § 23, a

twill will be more pronounced if produced in such a direction that the tendency of threads to untwist and roll out of their straight course will be prevented or checked. Thus, if the untwisting action of threads that form the ridges of the twill causes them to incline to the *left* the direction of the twill also should be produced to the left, whereby the threads will support each other, at the extremities of the float, on those sides towards which they tend to roll. If, however, the threads are left unsupported at those parts, as would occur if the twill were pro-

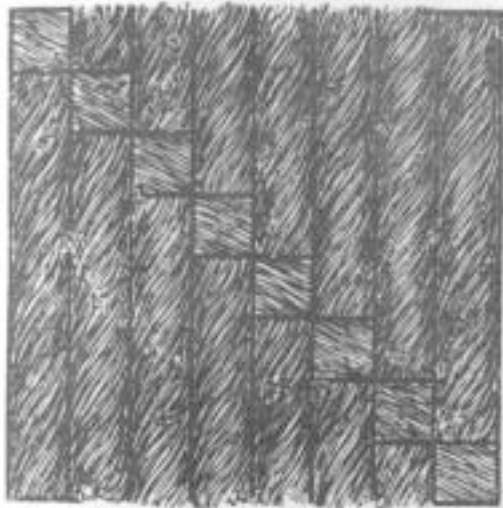

FIG. 59.—Showing the direction of twill for a warp-face twill fabric produced with warp yarn spun "twist-way," to develop a bold twill rib.

duced in the same direction as the angle of twist, their tendency to untwist and roll would be unchecked, and the floats would therefore assume a slight inclination in the reverse direction to the twill, as clearly observed in Fig. 56.

§ 26. But whatever may be the dominant factor determining the relative prominence of twills, it may be repeated that if they are produced in the reverse direction to that of the twist in the yarn, they will be more pronounced than if both the angle of twist and that of the twill are both inclined in the same direction.

And so long as this dictum is observed, it is immaterial in whichever direction a twill may incline, or in which direction the yarn is twisted during spinning. Therefore, if a bold warp twill is produced from yarn spun "twist-way," as indicated in Fig. 57, the twill should incline upward from *right to left*, as represented in Fig. 59. Likewise, if a weft twill is produced from yarn spun "weft-way," as indicated in Fig. 58, the twill also should incline upward from *right to left*, as represented in Fig. 60. (This may at first appear inconsistent, until it is observed that the direction or spirality of twist in a spun thread

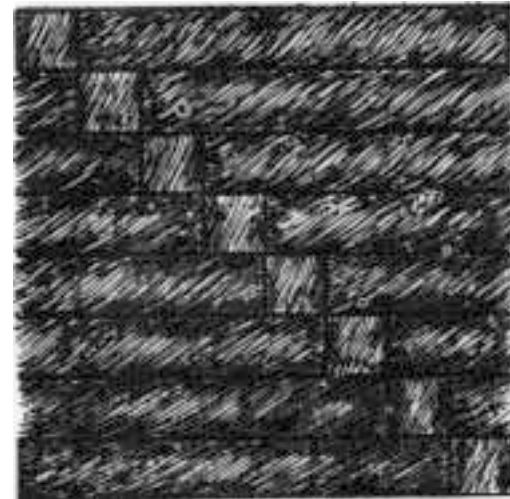

FIG. 60.—Showing the direction of twill for a weft-face twill fabric produced with weft yarn spun "weft-way," to develop a bold twill rib.

inclines in reverse directions when placed at right angles to itself, as indicated by arrows in Figs. 57 and 58.) Again, if a twill weave having warp and weft displayed in equal or nearly equal quantities on both sides of cloth is produced from warp spun "twist-way" and weft spun "weft-way," the twill should, in this case also, incline upward from *right to left*, as indicated in Fig. 61. If, however, a weft twill is produced from yarn spun "twist-way," or a warp twill from yarn spun "weft-way," the twill should incline upward from *left to right*, as indicated in Fig. 62.

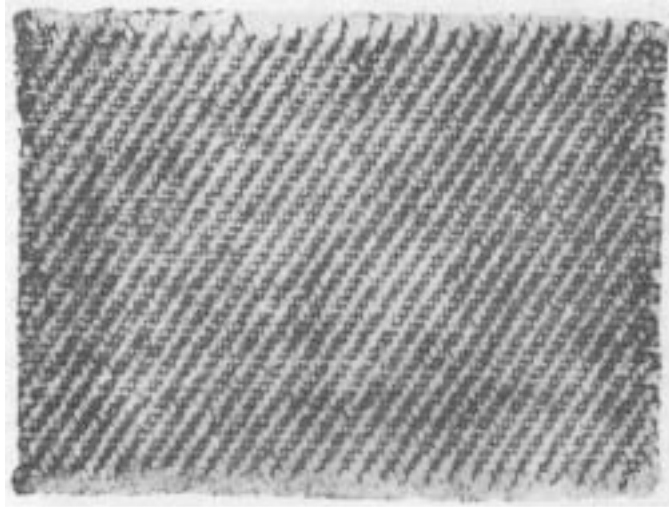

FIG. 61.—Showing the direction of twill in a fabric having a warp and weft face, and produced from warp yarn spun "twist-way," and weft yarn spun "weft-way," to develop a bold twill rib.

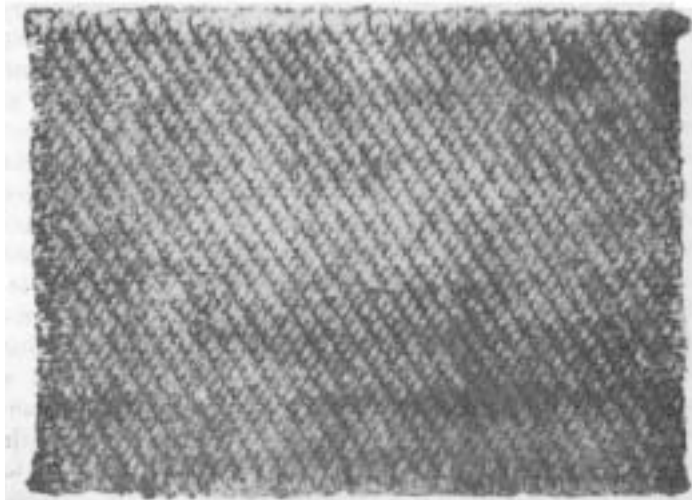

FIG. 62.—Showing the direction of twill in a weft-face twill fabric produced from yarn spun "twist-way" to develop a bold twill rib.

2. Zigzag or Wavy Twills.

§ 27. This subdivision of twill weaves comprises those in which the direction of twill is frequently reversed, to produce a series of waves running horizontally, obliquely or vertically, according to the particular manner in which the reversals are made. Any regular twill weave may be employed in the development of wavy twills; also the twill may be reversed at regular or irregular intervals on either warp threads or picks, according to the effect desired. It should be observed, however, that, as a rule, the best results will be obtained by reversing the twill on that series of threads which predominate on the face of

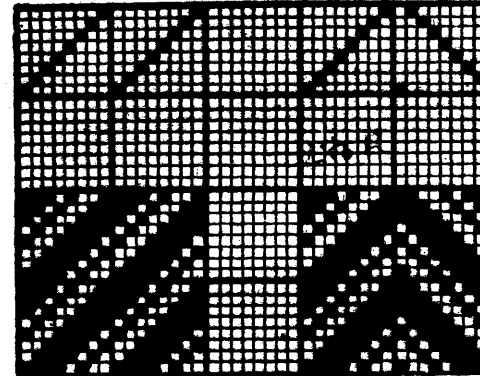

FIG. 63.

FIG. 64.

the fabric. Thus, if the warp preponderates over weft, the waves should reverse on warp threads; and if the weft preponderates over warp, the waves should reverse on picks of weft provided, of course, that the preponderating threads are not inferior either in number or quality. By adopting this course, long floats, which would otherwise occur at all points where the twill is reversed, and which look like imperfections in cloth, are avoided, and sharper wave crests and furrows are produced. The accompanying examples of wavy twills are uniformly based on the regular twill weave represented in Fig. 63, which repeats on eight warp threads and picks, and requires eight shafts of healds to weave it, with warp threads drawn through them with

a "straight-over" draft, as indicated above the design. This twill weave has warp preponderating over weft in the ratio of five of warp threads to three picks of weft, thus $\frac{4-1}{1-2} = \frac{5}{3}$.

Figs. 64, 65 and 66 are horizontal wavy twills produced by reversing the weave (Fig. 63) at regular intervals of eight, twelve and sixteen warp threads, thereby causing them to repeat on sixteen, twenty-four, and thirty-two warp threads, and only eight picks, respectively. As indicated by the drafts immediately above the designs, each design requires only eight shafts of healds (as does the original weave) for its production; but they would each require a different set of healds in consequence of

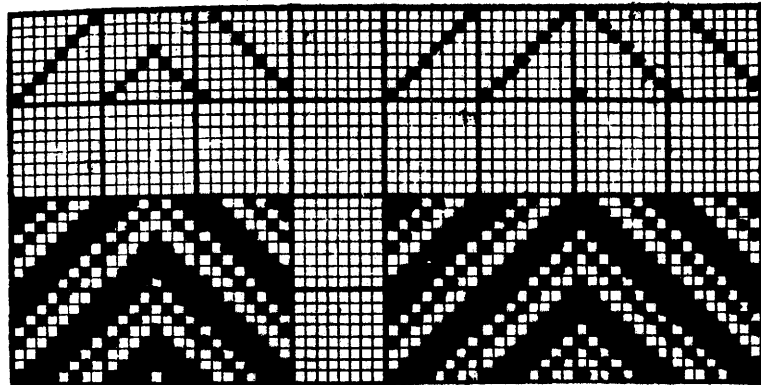

FIG. 65.

FIG. 66.

the different methods of drafting the warp threads through them. If the same weave (Fig. 63) were employed to produce similar wavy effects to those of Figs. 64, 65 and 66, but vertically instead of horizontally, the draft shown above (Fig. 63) would answer, and the healds would be raised in consecutive order, forward and backward alternately, for eight, twelve, and sixteen picks respectively, thereby causing the designs to repeat on twice that number of picks. This latter course would involve the use of dobbies or other shedding devices capable of weaving designs repeating on a large number of picks; whereas, in the former case, the designs could be woven by means of eight-pick tappets.

§ 28. Figs. 67, 68 and 69 are variegated wave effects produced by reversing the twill at irregular intervals of warp threads, so as to produce large and small waves in a horizontal

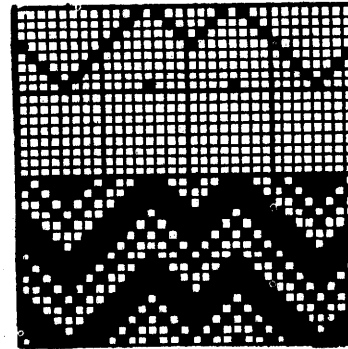

FIG. 67.

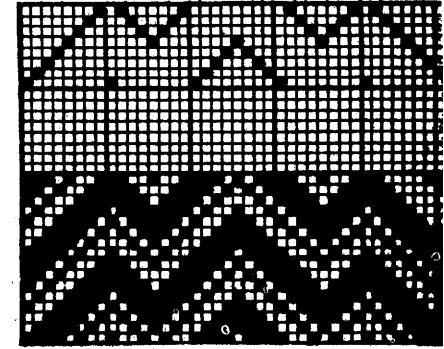

FIG. 68.

direction. In Fig. 67 the twill is reversed at intervals of four, eight, and four warp threads continuously. In Fig. 68 the intervals are eight, four, and eight warp threads continuously; and in Fig. 69 they are four, eight, four, eight, and four warp

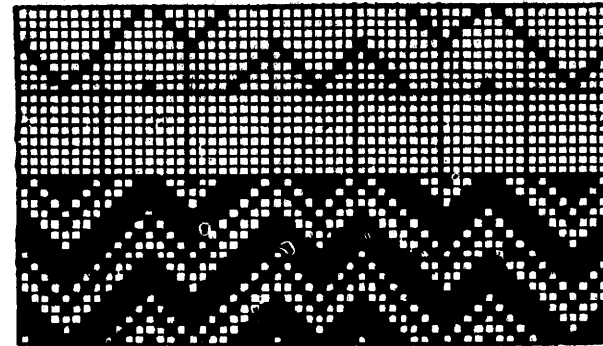

FIG. 69.

threads continuously. By thus reversing for an equal number of warp threads in both directions, the waves assume a horizontal course so far as one or more than one repeat of the pattern is concerned. Only eight healds are required to pro

duce these designs; but the drafting of warp threads through them must be as indicated above the respective designs. This causes the patterns to repeat on thirty-two, forty, and fifty-six warp threads, and eight picks respectively.

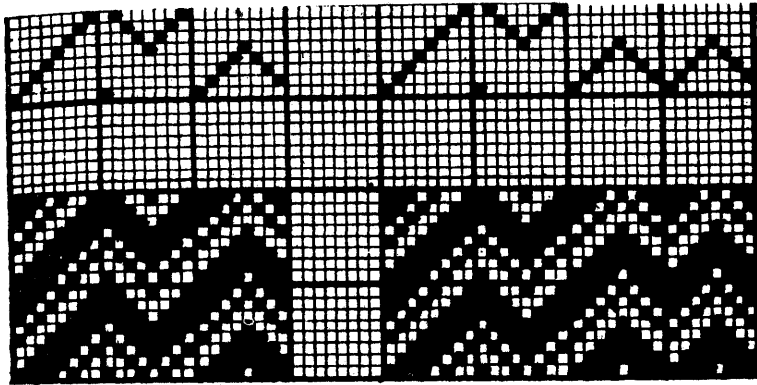

Fig. 70.

Fig. 71.

§ 29. Figs. 70, 71 and 72 are wavy effects in which the waves are produced obliquely by reversing the twill uniformly

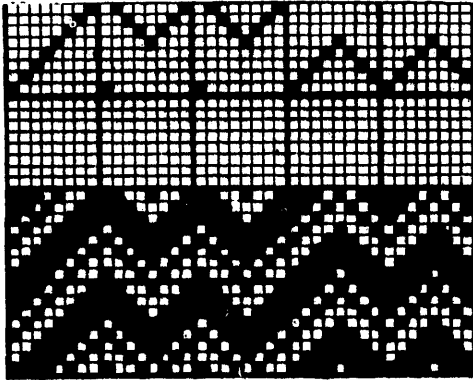

FIG. 72.

at shorter intervals in one direction than in the other. The obliquity of the waves may be more or less acute according to the system of reversing, and the intervals at which the reversals

occur, as seen in the examples given. In Fig. 70 the intervals are eight and four warp threads alternately, throughout. In Fig. 71 a more acute obliquity is obtained by reversing the twill at intervals of eight, four, eight, four, and four warp threads continuously; and in Fig. 72 a still more acute slant is produced by reversing the twill at intervals of eight, four, four, and four warp threads continuously. These designs repeat on eight picks, and require eight shafts of healds, with warp threads drafted as shown, to produce them. In the development of wavy twill designs, the relative sizes of waves are determined by the number of threads on which the twill is produced in any direction.

3. Rearranged Twills.

§ 30. Rearranged twills are those evolved by the rearrangement of either warp threads or picks of any regular or continuous twill weave, according to some definite plan. For example, consecutive threads of a given weave may be redistributed at regular intervals of two or more threads apart, as required; or, as an alternative method, threads of a given weave may be taken at intervals of two or more, and arranged consecutively to form a new design.

Satin Weaves.

The simplest application of this system of rearranging twill weaves obtains in the development of what are known as "satin" weaves, produced by rearranging simple continuous warp-face or weft-face twills (as represented in Figs. 31 to 35, and 37 to 41 respectively), according as warp-face or weft-face satin weaves are required. Satin weaves are characterised by an even and smooth surface, of either warp or weft, resulting from a perfectly regular distribution of intersections of those threads. They constitute one of the most useful varieties of weaves and are extensively employed, in conjunction with other weaves, as an element or component part of elaborately decorated fabrics, as well as in the production of piece-good fabrics constructed entirely on the basis of one of such weaves. Although satin weaves are (for convenience of classification) generally regarded

as derivations or rearrangements of simple continuous twill weaves, it will be seen that they bear no resemblance whatever to that class, but are entirely different in respect of the distribution of intersections.

§ 31. In the production of satin weaves, the intersections or binding points of warp and weft should be distributed as freely and far apart as possible, on such number of threads as are to constitute one repeat of the pattern. The more perfectly such distribution is accomplished, the more perfect will be the evenness and smoothness of cloth. The rearrangement of any continuous twill weave, to produce either a simple satin weave, or other design having a satin basis, may be made in accordance with an arithmetical formula to obtain the "interval of selection" which determines the positions of intersections or binding points on consecutive threads of either series for any size of satin weave, excepting those contained on four and six threads (which are imperfect satin weaves). Having decided upon the number of threads on which to construct a satin weave, the "interval of selection" may be either of the reciprocals of that number and which have no common measure.

Example : It is required to construct a ten-end satin weave. The only two reciprocals of ten, which have no common measure, are three and seven; therefore either three or seven may be taken as the "interval of selection," and the intersections disposed at intervals of three or seven threads of either series, on consecutive threads of the other series.

The application of this formula will be easily understood by reference to Fig. 73, where a ten-end weft-face satin (B) is produced by transposing the threads of a ten-end weft-face twill (A) in the manner indicated; namely, by disposing say every third warp thread A, in consecutive rotation to produce B. Or the same result is virtually attained by the method shown at Fig. 74, where consecutive warp threads A are redisposed at intervals of three threads to produce B. The only difference between Figs. 73 and 74 is in the reversed sequence of intersections. Again, similar results would obtain by rearranging picks instead of warp threads, and also by adopting the reciprocal number, seven, as the "interval of selection"

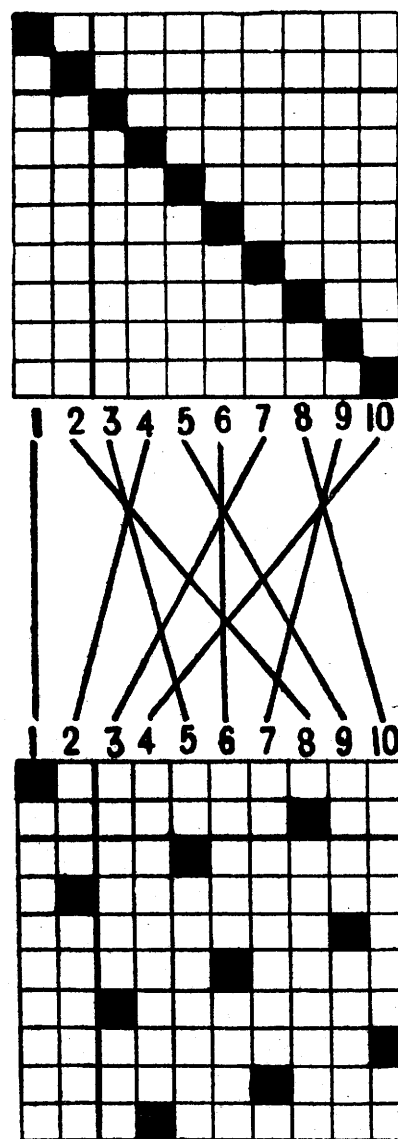

FIG. 73.—Showing the Construction of Satin Weaves.

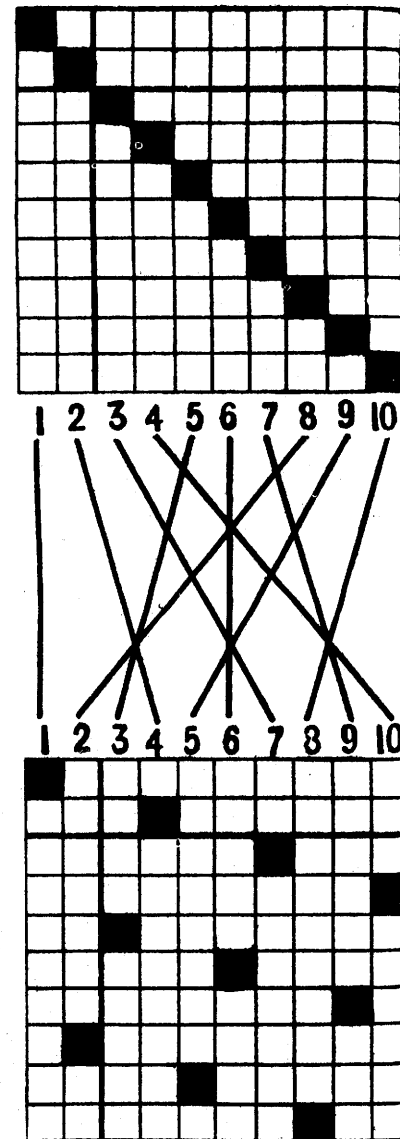

FIG. 74.—Showing an Alternative Method of Constructing Satin Weaves.

Some numbers, as five, eight, ten, and twelve, each permit of only two reciprocals which have no common measure; whilst some have four, and others more than four reciprocal divisions which have no common measure. As regards those numbers which have four minor reciprocal divisions, a similar distribution of intersections will result whichever one of the four divisions is

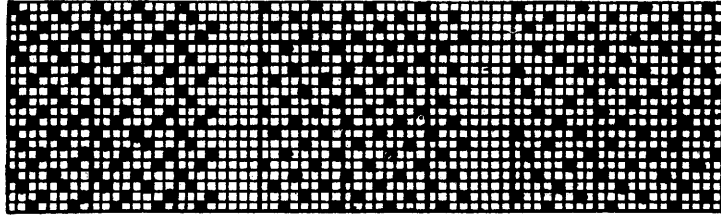

FIG. 75.

FIG. 76.

FIG. 77.

selected as the interval; but as regards those numbers which offer a greater choice of intervals, the choice of the best "interval of selection" is entirely a matter of judgment and not of rule. In such cases it is advisable to construct weaves based on each of the respective reciprocals, and then choose that "interval of selection" which gives the most perfect and regular distribution of intersections.

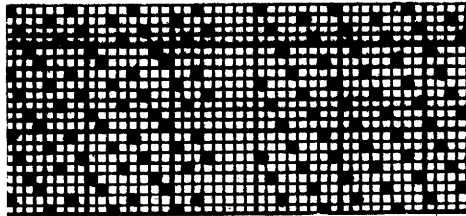

FIG. 78.

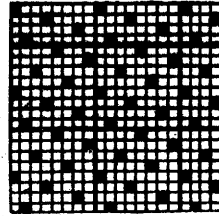

FIG. 79.

heavy type (or their reciprocals) will give the most perfect distribution of intersections; and those weaves indicated in *italics* are the only satin weaves (included in the following table) in which the distribution of intersections is geometrically perfect:—

TABLE OF INTERVALS OF SELECTION FOR THE CONSTRUCTION OF SATIN WEAVES.

<i>5-end satin</i> —2.	15-end satin—2, 4, 7.
7-end satin—2, 3.	16-end satin—3, 5, 7.
8-end satin—3.	<i>17-end satin</i> —2, 3, 4, 5, 6, 7, 8.
9-end satin—2, 4.	18-end satin—5, 7.
<i>10-end satin</i> —3.	19-end satin—2, 3, 4, 5, 6, 7, 8, 9.
11-end satin—2, 3, 4, 5.	20-end satin—3, 7, 9.
12-end satin—5.	21-end satin—2, 4, 5, 8, 10.
<i>13-end satin</i> —2, 3, 4, 5, 6.	22-end satin—3, 5, 7, 9.
14-end satin—3, 5.	

"Corkscrew" Twills.

§ 33 Corkscrew twills constitute a variety of rearranged twills largely employed in the production of worsted garment fabrics, for which they are eminently suited, as they are capable of producing firm and compact textures of great strength, warmth

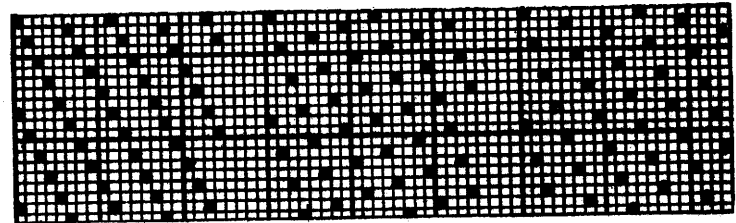

FIG. 81.

FIG. 82.

FIG. 83.

Figs. 76 and 79 to 94 are weft-satin weaves constructed in accordance with the above table. Fig. 75 is the so-called four-end "satinette" weave; and Figs. 77 and 78 are alternative arrangements of the six-end satin weave. The arrangement shown in Fig. 77 is preferable to that shown in Fig. 78, as it gives a more perfect distribution of intersections.

§ 32. The following table shows the *intervals of selection* for the construction of satin weaves on five, and seven to twenty-two threads. Instead of the numbers given, their reciprocals may be taken. Where two intervals are given, each of these or their reciprocals will produce similar results. Where more than two intervals are given, the number or numbers shown in

and durability. Perfect corkscrew weaves are characterised by a somewhat subdued twill formation, with either warp or weft only visible on the face of the fabric, and are usually constructed on an *odd* number of warp threads and picks. The latter

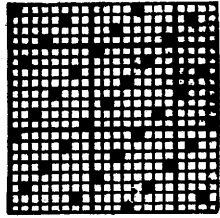

FIG. 84.

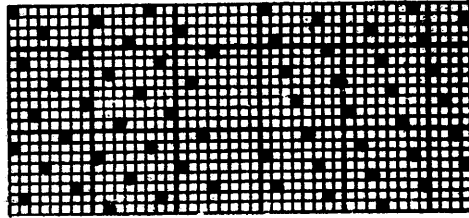

FIG. 85.

FIG. 86.

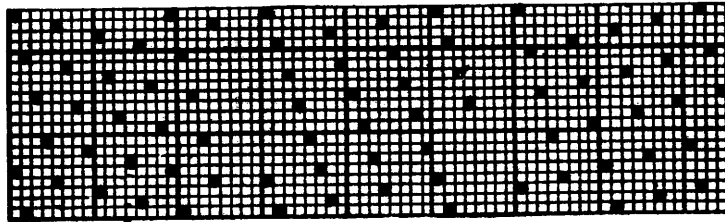

FIG. 87.

FIG. 88.

FIG. 89.

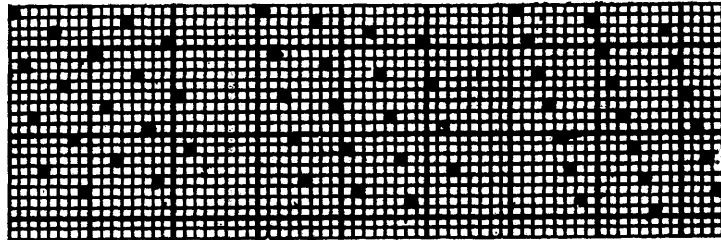

FIG. 90.

FIG. 91.

FIG. 92.

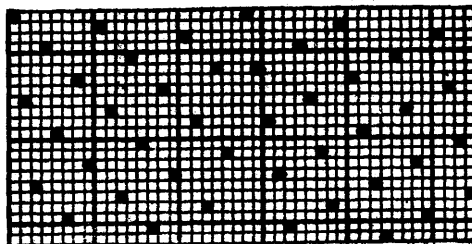

FIG. 93.

FIG. 94.

E

circumstance arises from the particular method of constructing these weaves, namely, by rearranging either series of threads of any suitable continuous twill weave at intervals of *two*, or

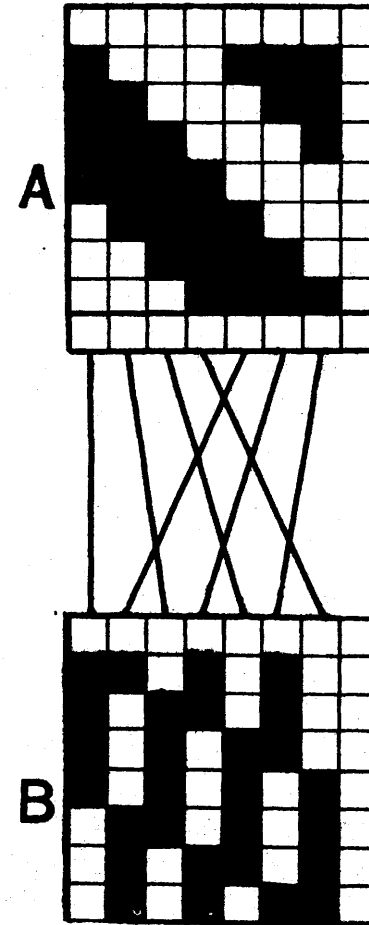

FIG. 95.—Showing the construction of warp-face corkscrew weaves.

alternately; and since two is not a measure of odd numbers, an *odd* number of threads is, therefore, required for one repeat of the pattern, in accordance with the principle governing the construction of satin weaves, as explained in § 31.

Warp-face corkscrew weaves may be produced by rearranging, in the manner described, the warp threads of any continuous twill that repeats on an *odd* number of threads, and in which

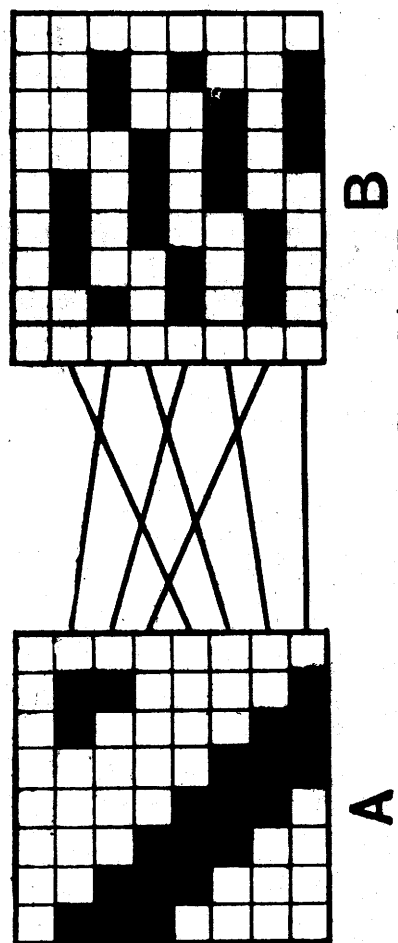

FIG. 96.—Showing the Construction of Weft-face Corkscrew Weaves.

warp floats are *one* thread only longer than weft floats. For weft-face corkscrews, the base pattern must have weft floating *one* thread more than warp; but whichever series of threads is

required on the face, they should be of better quality and in greater abundance than the other series.

Fig. 95 shows the method of constructing a warp-face corkscrew weave B, by rearranging warp threads of the seven-end (3^4) continuous twill weave A, in the manner indicated. It will be

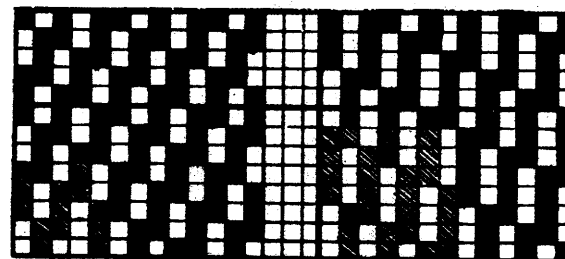

FIG. 97.

FIG. 98.

seen that B is produced by rearranging consecutive warp threads in A at intervals of two threads, or alternately, on the same number of warp threads. In like manner, a weft-face corkscrew B (Fig. 96) is produced by rearranging picks of the seven-end (4^2) continuous twill A. Figs. 97 to 101 are examples of perfect

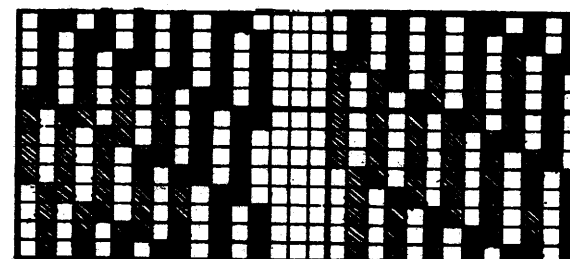

FIG. 99.

FIG. 100.

warp-face corkscrew weaves, and Figs. 102 to 106 of weft-face corkscrew weaves, repeating on five, seven, nine, eleven, and thirteen threads respectively. Judging from these weaves as indicated on design paper, in which the threads are represented as if spread out and lying parallel side by side without compression, it would appear that *weft* would be visible on the face of the fabric in warp-face corkscrews, and *warp* in weft-face

corkscrews. This would actually occur if the floating threads were not in considerably greater numbers and therefore more densely crowded than the other series of threads. But by

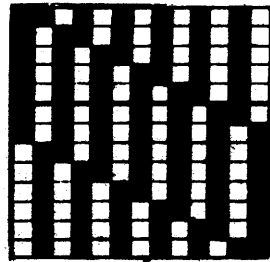

FIG. 101.

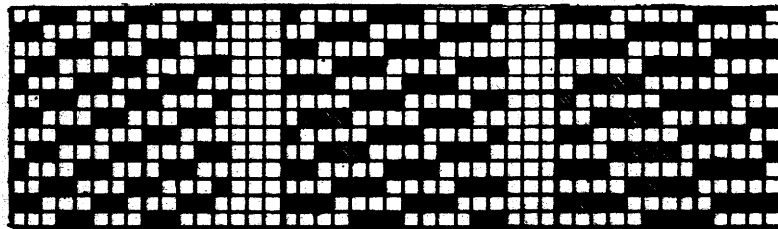

FIG. 102.

FIG. 103.

FIG. 104.

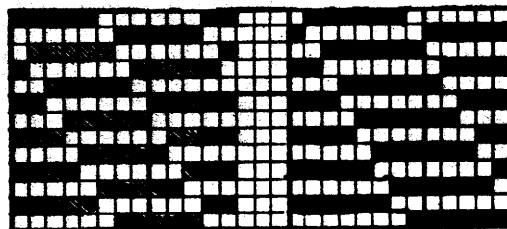

FIG. 105.

FIG. 106.

increasing the numerical density of floating threads, over covered threads, the latter will be quite obscured by the former closing over and entirely covering them.

§ 34. Corkscrew weaves may be modified to a considerable extent without departing from the general principle governing

their construction. They may also be made to assume varied and other decorative effects, as horizontal and oblique waves, and many others; but the necessity of having one series of threads greatly in excess of the other series prevents the successful employment, in bulk, of the sparse threads. Simple corkscrews may also be constructed on an *even* number of threads; but these will lack the perfect uniformity of surface

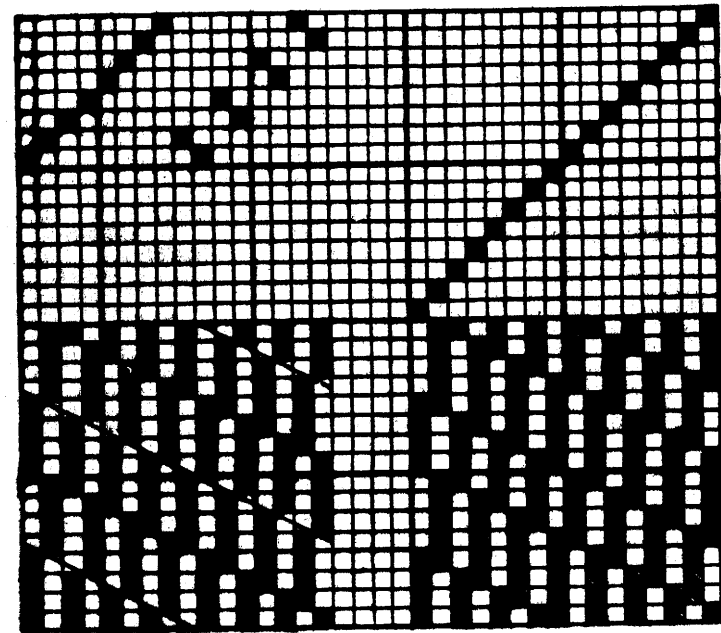

FIG. 107.—Even-thread Corkscrew Weave.

FIG. 108.—Even-thread Corkscrew Weave.

possessed by those constructed on an *odd* number of threads; yet, on the other hand, it opens out unlimited scope to a designer in the production of new and varied effects. It should be pointed out, however, that odd-thread warp-face corkscrews repeat on the same number of threads as their base weaves, and require only that number of healds to weave them; whereas even-thread warp-face corkscrews occupy twice as many threads as their base

weaves, and sometimes require twice that number of healds to weave them.

Fig. 107 is an example of an even-thread corkscrew weave, based on an eight-end four-and-four twill, and requiring sixteen warp threads and eight picks to complete the pattern. It is but slightly removed from a perfect corkscrew weave, and virtually consists of a double diagonal warp rib, separated by a single diagonal cutting of weft which emphasises the twill formation in cloth. Fig. 108 is another example of a corkscrew weave on eight threads, but without a definite twill formation. It is produced by causing alternate warp threads to float over one pick more than the others, thereby preventing weft from passing over more than one warp thread, as in perfect corkscrews. This unequal floating of warp threads will, of course, produce diagonal ribs of different widths; but that feature will be scarcely, if at all, discernible in the larger weaves, excepting where the variation in the length of float is considerable. It is worthy of note, also, from an economical point of view, that the slight departure in the construction of Fig. 108 involves the use of sixteen shafts of healds, with a straight-over draft, whereas Fig. 107 could be woven with only eight shafts of healds, with a broken draft, as indicated above the respective designs.

§ 35. It was explained in § 31 that satin weaves were evolved by rearranging threads of warp-face or weft-face continuous twill weaves in a prescribed manner. That system of rearrangement is equally applicable to other forms of continuous twills, and is one that offers considerable scope to a designer in the production of fancy weaves of great utility. Whatever form of twill weave may be selected, its rearrangement on a satin basis is governed by the same principle as that which operates in the construction of simple satin weaves. The weave to be rearranged must, of course, repeat on the same number of threads as that of the satin weave which forms the basis of rearrangement; otherwise the new design could not be completed on that number. The rearrangement may also be made in respect of either warp threads or picks of weft, with oftentimes very different results, as will be seen in some of the following examples. The best course to adopt, in the rearrangement of

twill, on a satin basis, is to indicate on design paper the particular satin weave required to form the basis of rearrangement, and then proceed to rearrange either warp threads or picks of

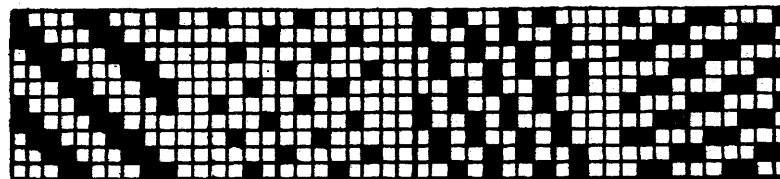

FIG. 109.

FIG. 110.

FIG. 111.

FIG. 112.

the base twill weave, according to the disposition of the binding points indicated, which serve as starting-points. In the following examples, illustrating the development of designs by this

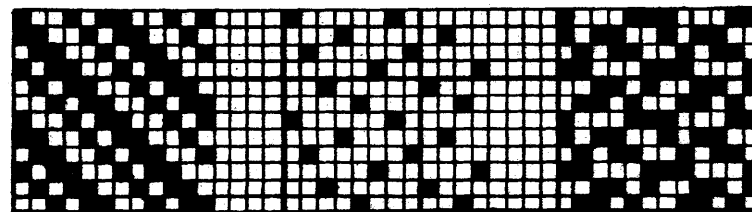

FIG. 113.

FIG. 114.

FIG. 115.

method, shaded squares in the base weaves indicate the *twill* basis; whilst in the re-formed designs, shaded squares indicate the *satin* basis on which they are rearranged.

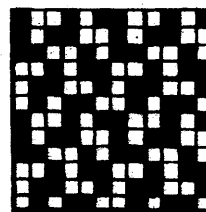

FIG. 116.

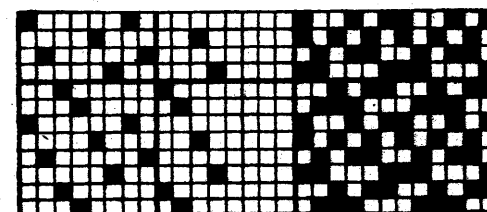

FIG. 117.

FIG. 118.

Fig. 109 is a twill weave contained on five threads, and constitutes the base weaves for designs Figs. 111 and 112. Fig.

111 is produced by rearranging *warp threads* of Fig. 109 on a five-end satin basis, as indicated in Fig. 110. Fig. 112 is another weave produced by rearranging, in the same order, *picks of weft* of the same base weave. Figs. 115 and 116 are rearrangements of warp and weft threads respectively of a six-end twill (Fig. 113) on the six-end satin basis indicated in Fig. 114;

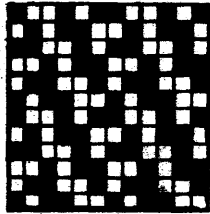

FIG. 119.

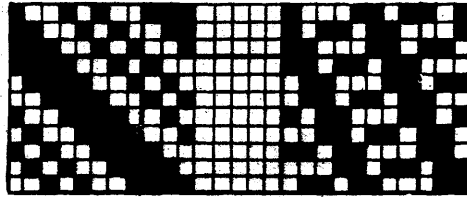

FIG. 120.

FIG. 121.

whilst Figs. 118 and 119 are rearrangements of warp and weft threads respectively of the same base weave (Fig. 113), but on the six-end satin basis indicated in Fig. 117.

When a base weave repeats on such a number of threads as will permit of two or more "intervals of selection" that are not reciprocal numbers, a proportionately greater diversity of new

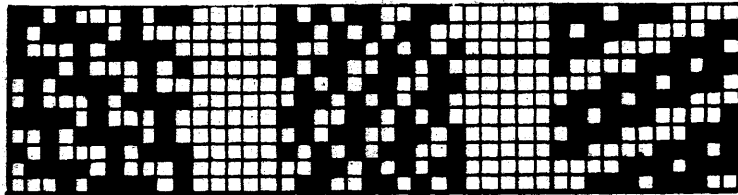

FIG. 122.

FIG. 123.

FIG. 124.

weaves may be produced from that base weave by rearranging the threads on the respective intervals afforded by the original number. For example, a base twill weave (Fig. 120) repeating on eleven threads, may be rearranged so as to produce a range of eight different weaves constructed on a satin basis, because eleven is a number which gives eight intervals of selection, namely, two, three, four, and five, and their reciprocals nine

eight, seven, and six respectively. Therefore, by rearranging both warp and weft threads on each of these intervals, eight different designs are obtained. Figs. 121 to 124 are produced by rearranging warp threads, and Figs. 125 to 128 are produced by rearranging picks of weft, at intervals of two, three, four, and five threads respectively.

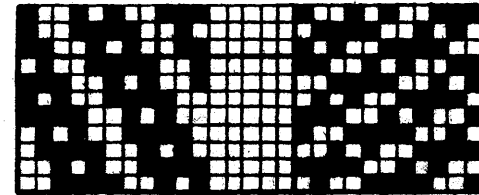

FIG. 125.

FIG. 126.

§ 36. Another method of rearranging either warp or weft threads of a base pattern, to create new designs, is by adopting a uniform interval of two threads irrespective of the number of threads on which the original weave is contained. This system, however, offers considerably less scope to a designer than the foregoing, and should only be employed for the production of

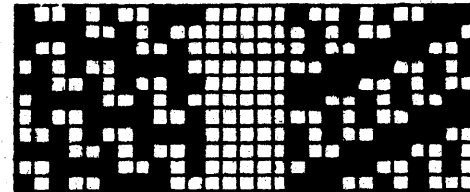

FIG. 127.

FIG. 128.

weaves in which a decided twill formation will not be displeasing. By this system, a twill formation will almost inevitably result in all cases, in consequence of laying alternate threads of a base weave in consecutive rotation, or *vice versa*. If warp threads are rearranged, the twill will approach the vertical, and if weft threads are rearranged, the twill will approach the horizontal.

It should be observed that by this system, rearranged weaves

based on odd-thread weaves will repeat on the same number of warp threads and picks as that of their base weaves; whilst those based on even-thread weaves will repeat on only one-half the number of threads in one direction, as that of their base

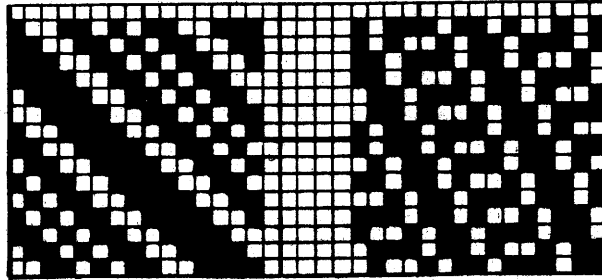

FIG. 129.

FIG. 130.

weaves. This is explained by the fact that *two* (the interval employed) is a measure of *even* numbers, but not of *odd* numbers. Therefore, designs repeating on an odd number of threads require them all to be employed in order to complete the new design; whilst only one half are necessary in respect of even-thread designs.

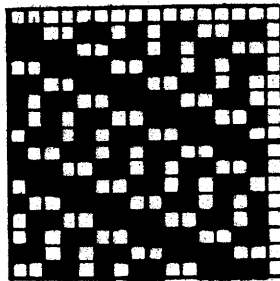

FIG. 131.

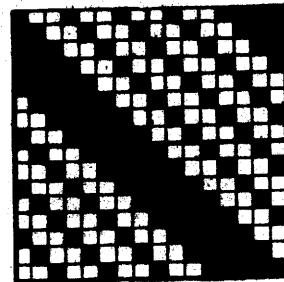

FIG. 132.

Figs. 129 to 134 will serve to demonstrate the application of this principle of rearrangement in the creation of new designs. Fig. 129, a twill weave contained on fifteen warp threads and picks, is selected as the base weave. By placing alternate warp threads of the base weave in consecutive rotation until the

pattern is complete, a new design repeating on fifteen warp threads and picks, as indicated in Fig. 130, is obtained. In like manner, if alternate picks of weft of the base weave are placed in consecutive rotation, the weave indicated in Fig. 131 is obtained. The only difference between the two new designs is in respect of the angle of twill, as just explained.

Figs. 133 and 134 are produced by rearranging, in a similar manner, warp threads and picks of weft respectively, of a base weave (Fig. 132) contained on an *even* number of threads, namely, sixteen. Since only one half the number of warp threads in the base weave are required to produce Fig. 133, the latter is complete on eight warp threads and sixteen picks. Also, for a similar reason, but in respect of picks, Figs. 134 is complete on sixteen warp threads and eight picks, as indicated in both cases by shaded squares.

4. Combined Twills.

§ 37. Combined twills are those produced by arranging the threads of two continuous twill weaves alternately with each other. Either warp threads or picks of weft of the two base weaves may be alternated. If warp threads are combined, the

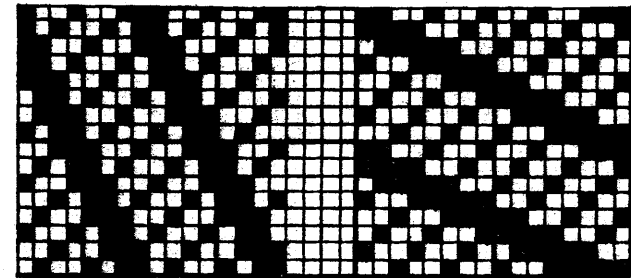

FIG. 133.

FIG. 134.

angle of twill in the resultant weave will be less than forty-five degrees; but if picks are combined, the angle of twill will be greater than forty-five degrees to picks of weft. If it is desired to produce a low-angle twill by this method, the best results will be attained by selecting two base weaves in which weft prepon-

derates over warp. For high-angle twills, the base weaves should have warp preponderating over weft.

By this system of combination, there is practically no limita-

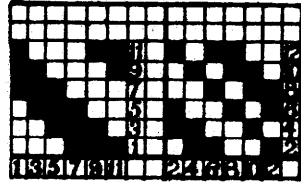

FIG. 135. FIG. 136.

tion to the production of new weaves of great variety and interest, and of great value to the textile designer. It obtains

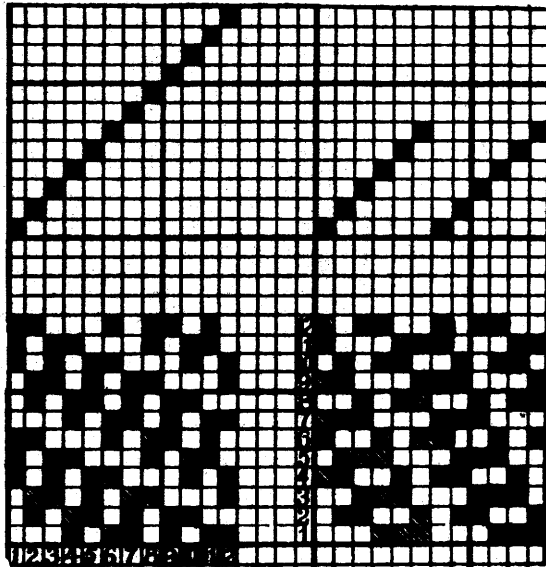

FIG. 137.—Design evolved by an end-and-end combination of Figs. 135 and 136.

FIG. 138.—Design evolved by a pick-and-pick combination of Figs. 135 and 136.

almost exclusively in the worsted industry in the production of garment fabrics, as it is capable of producing compact and firm textures.

Any two weaves may be combined in the manner described, irrespective of their relative sizes. The size of the resultant weave, however, depends upon the number of threads occupied by the respective base weaves employed. Thus, if two base weaves, each occupying the same number of threads, are combined end and end (*i.e.*, a warp thread from one weave, and a warp thread from the other alternately), one repeat of the combined twill weave will occupy twice as many warp threads, and the same number of picks, as those of the respective base weaves.

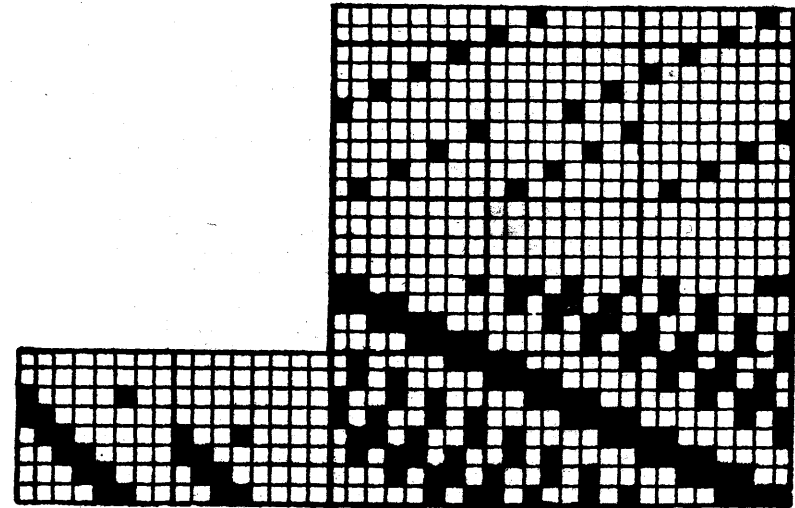

FIG. 139.

FIG. 140.

FIG. 141.—Design evolved by an end-and-end combination of Figs. 139 and 140.

If, on the other hand, the base weaves are combined pick and pick, the combined twill would occupy twice as many picks, and the same number of warp threads, as either of the base weaves. For example, Figs. 135 and 136 are two continuous twill weaves, each repeating on six warp threads and picks. By combining them end and end a new design is produced, repeating on $6 \times 2 = 12$ warp threads and six picks, as shown in Fig. 137. If picks instead of warp threads of the same base weaves are alternated, a new weave is produced, repeating on six warp threads, and $6 \times 2 = 12$ picks, as shown in Fig. 138.

If two weaves, each repeating on a different number of threads, are combined end and end, the resultant weave will repeat on such number of warp threads as equals the least common multiple of those numbers, multiplied by 2; and on such

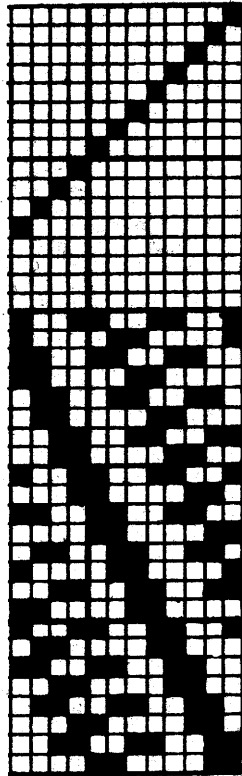

FIG. 142.—Design evolved by a pick-and-pick combination of Figs. 139 and 140.

number of picks as equals the least common multiple only of those numbers. This rule also applies in a corresponding manner if picks of weft are combined. *Example*: two weaves, Figs. 139 and 140, repeat on four and six warp threads and picks respectively. If combined end and end, the resultant weave, Fig. 141, will repeat on twenty-four warp threads and

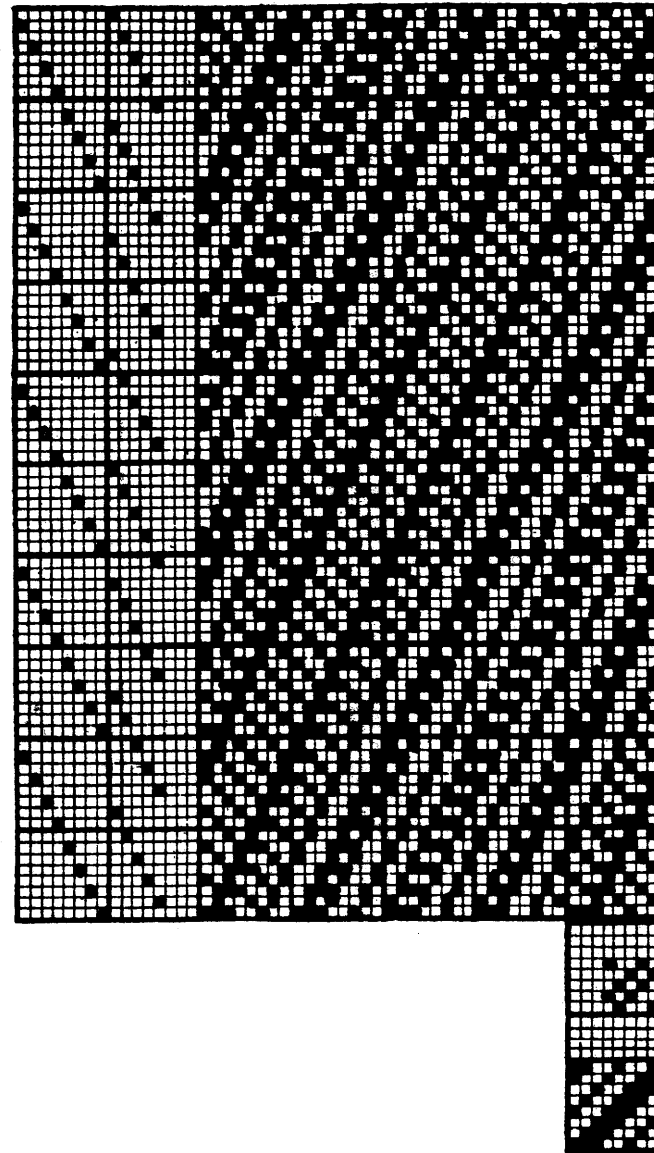

FIG. 145.—Design evolved by End-and-end combination of Figs. 143 and 144.

FIG. 143, FIG. 144.

twelve picks, because twelve is the least common multiple of the numbers four and six. By combining the same base weaves pick and pick, a design is produced, repeating on twelve warp threads and twenty-four picks, as shown in Fig. 142. If two weaves repeating on eight and five threads respectively are

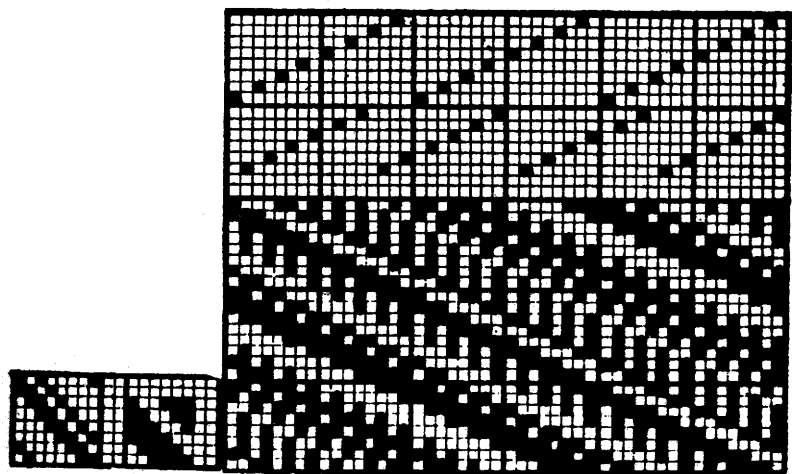

FIG. 146. FIG. 147. FIG. 148.—Design evolved by an end-and-end combination of Figs. 146 and 147.

combined, the resultant weave will occupy forty threads in one direction, and eighty in the other direction, according to which series of threads are combined. This is exemplified by Fig. 145, which is produced by combining end-and-end the base weaves, Figs. 143 and 144, repeating on eight and five threads respectively.

It should be observed that although a combined twill weave obtained by alternating warp threads of two base weaves may occupy many times more warp threads than either of its base weaves, it will only require, for its production, such number of healds as equals the sum of those required to weave the respective base weaves; whereas, if picks of weft of two base weaves are alternated to produce a combined twill weave, the number of healds required to weave it corresponds with the number of warp threads occupied by the resultant weave. This is

F

indicated by the drafts placed above the respective designs. It will be seen that a design produced by combining picks may be woven with a "straight," *i.e.*, continuous, drafting; whereas, one produced by combining warp threads will require what may be termed a "compound" draft, *i.e.*, in which the healds are

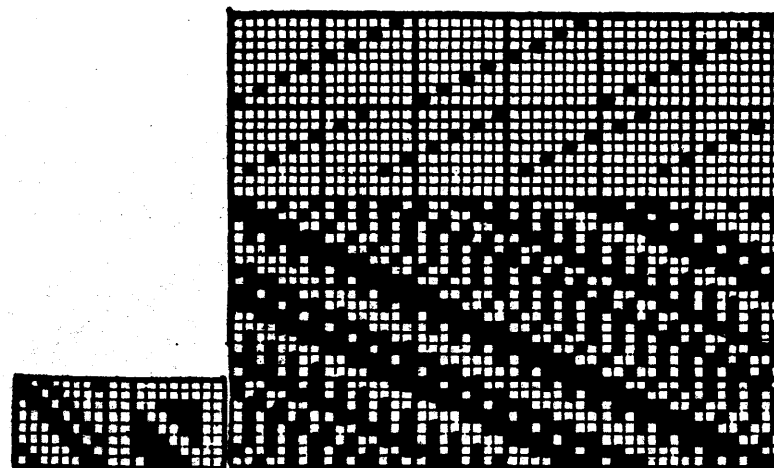

FIG. 149. FIG. 150. FIG. 151.—Design evolved by an end-and-end combination of Figs. 149 and 150.

virtually in two sets—one set governing alternate warp threads in accordance with one base weave, and the other set governing the remaining warp threads in accordance with the other base weave, and with each division of threads drawn "straight through" on their respective sets of healds, as shown.

By this system of combining twill weaves, additional scope is sometimes offered a designer in the production of varied effects, even from the same base weaves, by the simple expedient of placing the latter in different relative positions; that is, by placing the threads of one weave one thread, or more than one thread, in advance or in rear of those of the other weave. This is exemplified by Figs. 146 to 151. Figs. 146 and 147 are two base weaves, repeating on eight and six threads respectively, and combined end and end to produce design Fig. 148. By

combining the same base weaves, but in the relative positions shown in Figs. 149 and 150, a new design, Fig. 151, is produced.

5. Broken Twills.

§ 38. Broken twills comprise that class of weaves produced by breaking the continuity of any continuous twill weave at either regular or irregular intervals of threads. Such a course somewhat tends to the formation of stripes, either in the direction of warp or of weft, according as the twill is broken lengthwise or crosswise respectively. If the twill is broken at regular intervals of threads the stripes will be of uniform width; but if broken at irregular intervals the stripes will be variegated. In either case the stripes will be more or less pronounced according to the character of twill employed, and the manner in which it is broken. The twill may incline in one direction throughout, or it may be reversed in alternate stripes, or in any other

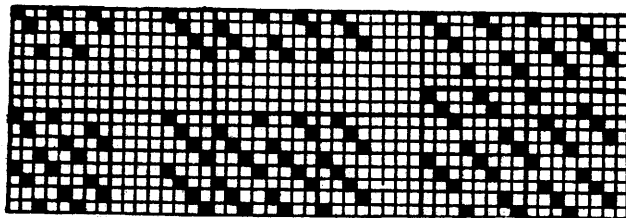

FIG. 152.

FIG. 153.

FIG. 154.

manner, to emphasise the striped effect. The stripe formation may also be emphasised by the principle of counterchange effected by reversing the weave after each break, as in Figs. 155 to 162, and 165 and 166. The reversal of weave may also be made in conjunction with a reversal of the direction of twill (to obtain a still more pronounced stripe formation) as exemplified in Figs. 170 to 176.

Fig. 152 is one of the simplest examples of a broken twill weave in which the twill inclines in the same direction throughout. It is based on the four-end weft-face twill, broken at intervals of two warp threads, and advanced one pick at a time after each break. The pattern is complete on eight warp threads and four picks, and may be woven with only four healds, drafted

in the manner indicated above the design. In the following examples, shaded squares indicate one repeat of the pattern, and the drafts are indicated above their respective designs.

Figs. 153 to 166 are other examples of broken twill weaves, based upon (a) simple, (b) even-sided, and (c) uneven-sided

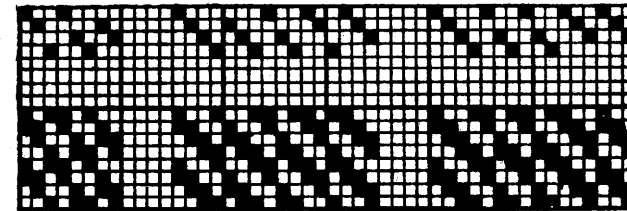

FIG. 155.

FIG. 156.

FIG. 157.

twill, in all of which the twill inclines in the same direction throughout. Fig. 153 is also based on the four-end weft-face twill, broken at intervals of four warp threads, and advanced one pick after each break; whilst Fig. 154 is produced by breaking a five-end weft-face twill at intervals of three warp threads, with a very different result.

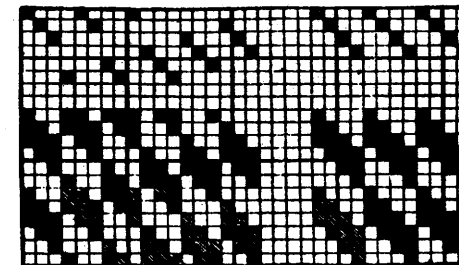

FIG. 158.

FIG. 159.

Figs. 155 and 156 are produced by breaking a four-end two-and-two twill at intervals of two and four warp threads respectively; whilst Fig. 157 is based on the same weave broken at irregular intervals of five and three warp threads alternately.

Figs. 158 to 160 are all based on a six-end three-and-three twill, broken at intervals of three, four, and five warp threads

respectively. Fig. 161 is based on the same weave, broken at irregular intervals of eight, four, two, four, two, and four warp threads.

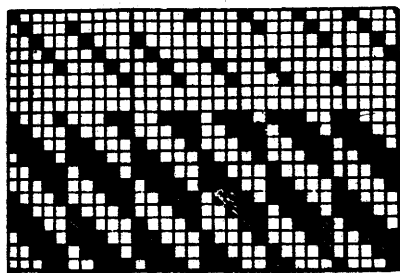

FIG. 160.

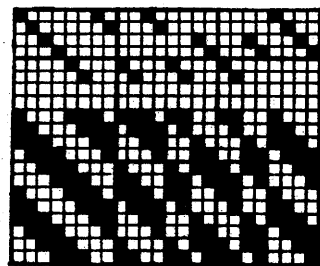

FIG. 161.

Fig. 162 is also based on an even-sided twill, but of different construction to that employed for the last four designs. The base weave is an eight-end $\frac{3}{2}\frac{1}{2}$ twill, broken at intervals of five threads, with the weave entirely reversed, but with the twill

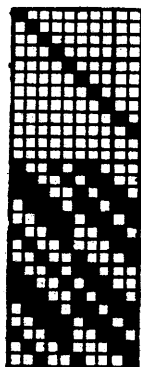

FIG. 162.

continued in the same direction. By reason of the foregoing even-sided twills being broken in the manner indicated, they are counterchanged in respect of the weave only, and not in respect of the direction of twill, which remains the same throughout.

Figs. 163 and 164 are based on the uneven-sided five-end two-and-three twill, broken at intervals of three and five threads

respectively; whilst Fig. 165 is based on the same weave, broken and counterchanged at irregular intervals of ten, two, five, and two warp threads.

Fig. 166 is based on the six-end four-and-two twill, broken and counterchanged at intervals of eight, four, two, four, two, and four warp threads.

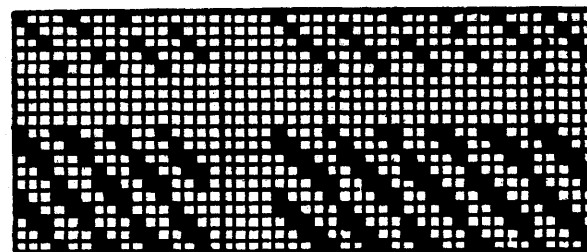

FIG. 163.

FIG. 164.

Although the foregoing examples illustrate the development of broken twill weaves having the twill in one direction only, they serve equally well to demonstrate the formation of those in which the twill is reversed, i.e., produced to the right and left alternately, or otherwise. The simplest example of this

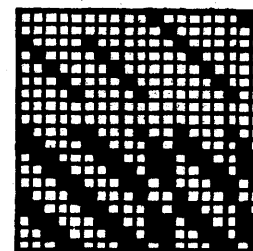

FIG. 165.

variety is that shown in Fig 167, based on the simple four-end weft twill, and well known as the four-end satin or satinette weave. It is produced by breaking and reversing either warp threads or picks at intervals of two threads. Figs. 168 and 169, known as "rice" weaves, are produced in a similar manner by breaking and reversing simple six-end and eight-end weft twills at intervals of three and four threads respectively.

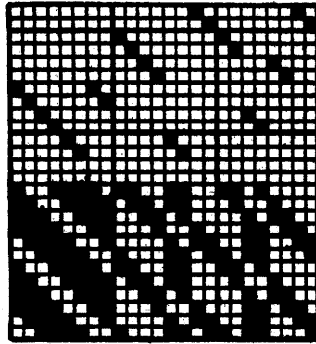

FIG. 166.

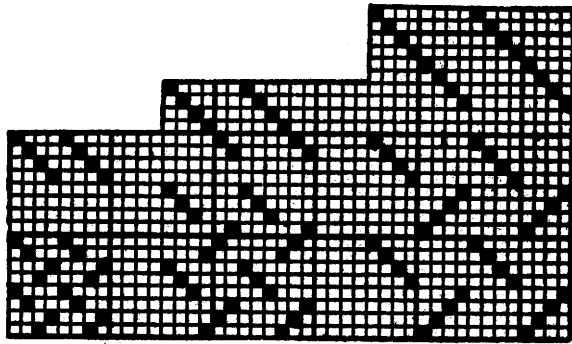

FIG. 167.

FIG. 168.

FIG. 169.

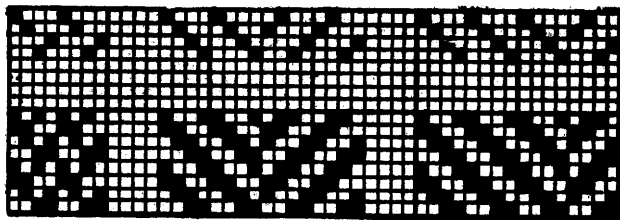

FIG. 170.

FIG. 171.

FIG. 172.

The next and last variety of weaves to be described under this division comprises those in which the twill is broken and reversed in counterchange—a plan largely adopted by designers in the construction of garment and other fabrics requiring good

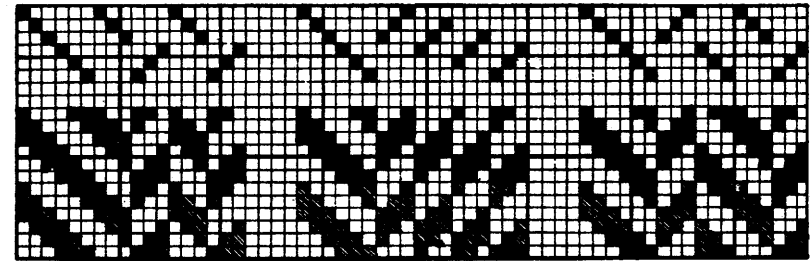

FIG. 173.

FIG. 174.

FIG. 175.

wearing properties, and capable of resisting tensile strain in all directions.

One of the simplest examples of this variety is that shown in Fig. 170, produced by breaking and reversing, in counter-

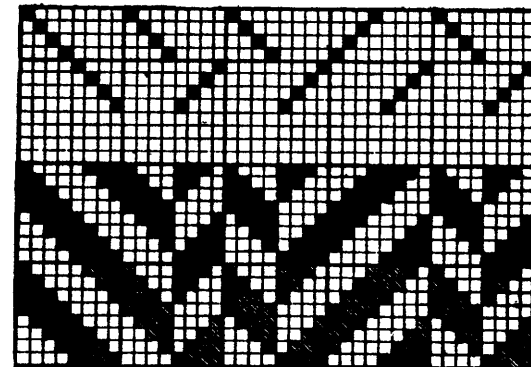

FIG. 176.

change, the four-end two-and-two (also known as the "Harvard") twill, at intervals of two warp threads. This weave is extensively employed in all classes of fabrics, as it produces a comparatively firm and compact texture. As a neutral ground filling of a subdued character, for light or medium brocade

fabrics figured by a Jacquard machine, it cannot be excelled. If the twill of this or similar twill weaves is continued for a number of threads and then reversed, as in Fig. 171, it produces the well-known "herring-bone" effect, repeating, in this case, on sixteen warp threads and four picks. Other examples of this class of weaves are given in Figs. 172 to 176, which are sufficient to indicate the general lines on which they are constructed, and the immense scope which this plan offers in the development of new weaves of great variety and utility.

6. Figured or Ornamented Twills.

§ 39. This division of twills comprises that variety of weaves produced by combining simple figuring, with a twill weave, as a means of embellishment. The amount of embellishment may vary from the least departure from a normal twill, to a degree when there is little to identify it as a twill weave, beyond its diagonal formation. It must not be assumed from this that all patterns having a diagonal formation may be classed as figured twills; but only such as conform, in some measure, to the general principles governing the construction of twill weaves.

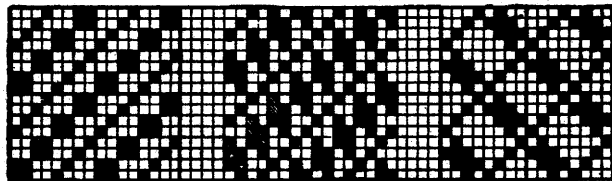

FIG. 177.

FIG. 178.

FIG. 179.

The term "figured twills" is here used to signify only such weaves of that class as may be produced by the aid of tappets and dobbies. The present examples will, therefore, be confined to such as will require not more than twenty healds to weave them. Notwithstanding this limitation, the construction of figured twills virtually affords illimitable scope to a designer, since he is no longer restricted to twilled effects pure and simple, but may call to his aid all the elements of fabric structure.

The additional scope which this class of design offers to a

designer demands both greater technical and artistic ability than is required for the simpler varieties of twill weaves. In the latter, the perfect regularity of weave causes uniform tension upon all warp threads, thereby producing a general evenness of texture throughout; whereas, in the former class, care must be taken to ensure sufficient and uniform interlacement of threads;

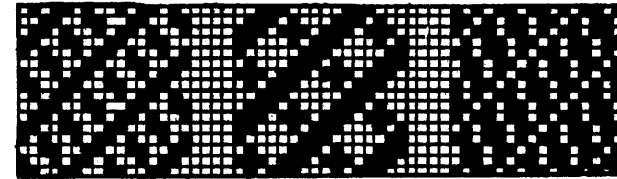

FIG. 180.

FIG. 181.

FIG. 182.

otherwise some portions of the fabric will be flimsy and weak, and some threads will be subjected to greater strain than others, thereby causing a crimped or wrinkled appearance in cloth. These precautions must be taken when producing designs for any class of fabric in which warp threads, during weaving, are delivered from one warp beam only.

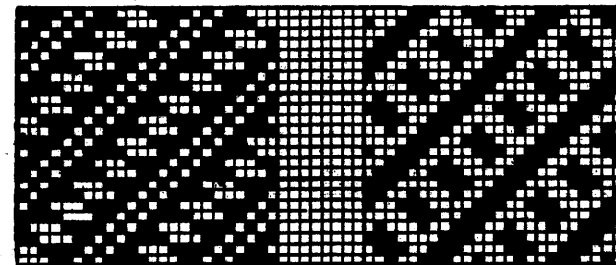

FIG. 183.

FIG. 184.

The present examples are illustrative of figured twill weaves, repeating on eight, twelve, sixteen, and twenty warp threads and picks. Little can be said regarding their construction, as they are not conformable to any definite rules, but depend wholly upon the imagination and technical ability of the designer. It should be observed, however, that whatever is introduced or combined with a twill weave, as a recurring element, it must

recur on such number of threads (counting diagonally) as constitutes a measure of the total number of threads on which the pattern is required to repeat, otherwise the continuity of the

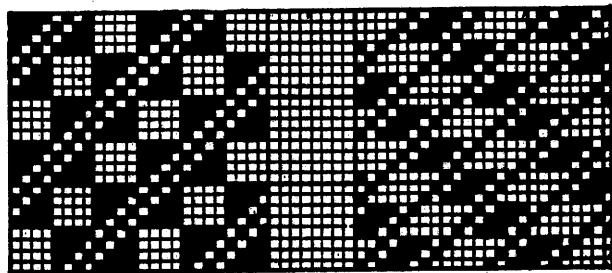

FIG. 185.

FIG. 186.

pattern will be broken. For example, if a pattern is required to repeat on twenty warp threads and picks, figuring elements may

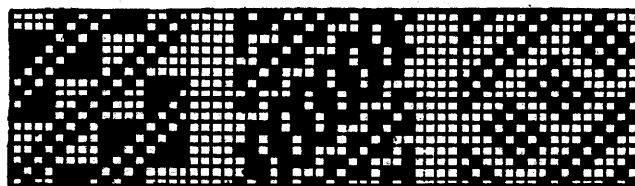

FIG. 187.

FIG. 188.

FIG. 189.

recur at intervals of two, four, five, or ten threads diagonally. This will be better understood by reference to the accompanying

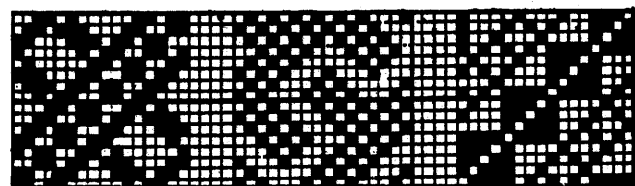

FIG. 190.

FIG. 191.

FIG. 192.

designs. Figs. 177 to 182 are various forms of twill weaves, repeating on eight warp threads and picks, to which are added simple figuring devices, disposed at intervals of two threads diagonally, in Figs. 177, 178, 180 and 182; whilst in Figs. 179

and 181 the devices are four threads apart, counting from and to corresponding points.

Figs. 183 to 186 are designs repeating on twelve warp threads

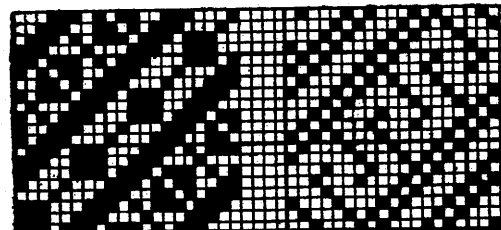

FIG. 193.

FIG. 194.

and picks, with the figuring devices recurring at intervals of two, three, four, and six threads respectively.

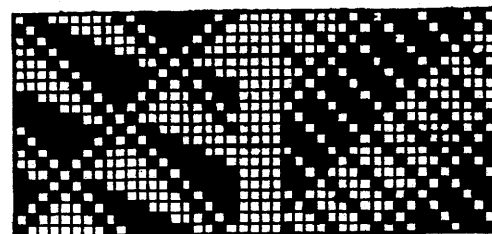

FIG. 195.

FIG. 196.

Figs. 187 to 192 are designs repeating on sixteen threads each way. In Fig. 188 the figuring units recur at intervals of two

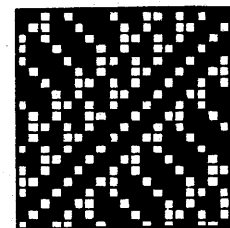

FIG. 197.

threads; in Figs. 187 and 189, at intervals of four; in Fig. 191, at intervals of eight; whilst in Figs. 190 and 192, some devices

recur at intervals of two, and others at intervals of four threads.

Figs. 193 to 197 are designs repeating on twenty threads each way, with the figuring devices recurring at intervals of five threads in Figs. 193, 194 and 195, and at intervals of two threads in Figs. 196 and 197.

Although examples of figured twills could be multiplied *ad libitum*, the foregoing are sufficient to indicate the immense scope they offer for the production of varied effects suitable for all classes of fabrics.

CHAPTER IV.

DIAMOND AND KINDRED WEAVES.

§ 40 Diamond weaves comprise all such weaves as are characterised by a diamond or a lozenge general formation. They may be produced in infinite variety, and constitute one of the most valuable classes of weaves for almost any type of fabric. They may be constructed with either warp or weft preponderating on the face of the fabric, or with each developed in equal quantities as required, and may be made to yield either a comparatively smooth or else a very rough and open texture, as exemplified in honeycomb and similar weaves. Their diamond or lozenge formation may be more or less pronounced, or even entirely obscured, as in honeycomb and similar weaves, which are characterised by a more or less distinct rectangular cellular formation.

The simplest example of a diamond weave is that contained on four warp threads and picks, as shown in Fig. 198, formed by producing a four-end weft twill to both the right and left. Larger weft diamond weaves of a simple character are formed by crossing larger twill weaves in a similar manner; thus Figs. 199 and 200 are produced from six-end and eight-end weft twill weaves respectively.

Although diamond weaves may be made on any number of threads, those contained on an even number may be produced with sharper definition than those based on an odd number, providing the opposing twills cross on a single warp thread and pick, as in Figs. 198 to 200, and not on two contiguous threads, as in Figs. 201 to 203, which are contained on five, seven, and nine threads respectively.

Figs. 204 to 213 are a few examples of diamond weaves repeating on twelve warp threads and picks uniformly, and are

given merely as suggestions indicating general methods of procedure in their development. In all cases their diamond formation is apparent, although they are not all actually based upon twill weaves produced in opposite directions. A careful

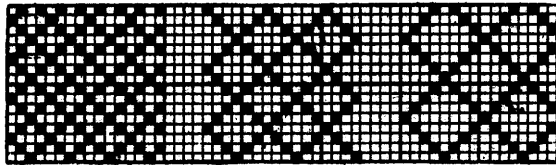

FIG. 198.

FIG. 199.

FIG. 200.

examination will reveal the means by which the different results are attained, and students are urged to make original designs of a similar character and so develop the faculty of invention in constructive textile design.

Honeycomb and Kindred Weaves.

§ 41. One of the most interesting varieties of weaves based, with few exceptions, on the diamond, are what are technically termed "honeycomb" weaves, from their partial resemblance to the hexagonal honeycomb cells of wax in which bees store their honey. As previously stated, these weaves are characterised by a more or less distinct cellular formation, which imparts to cloth a

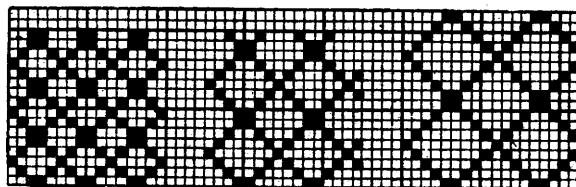

FIG. 201.

FIG. 202.

FIG. 203.

somewhat rough and rugged appearance, as seen in Figs. 214 and 215, which are photographs of actual examples of cloth, representing two of the best-known varieties of this class of weaves, namely, "honeycomb" proper, and "Brighton" weaves respectively. The peculiar character of texture resulting from honeycomb weaves in general, and particularly from those just

named, renders them eminently suited for use as bathroom towels, which require to be soft and absorbent, and for which

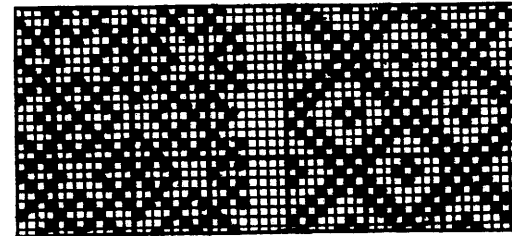

FIG. 204.

FIG. 205.

use they are extensively employed. They are also very largely used in the production of heavy cotton and woollen textures for

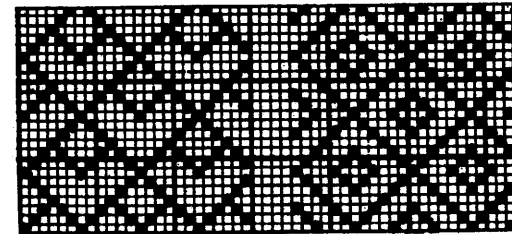

FIG. 206.

FIG. 207.

ladies' winter garments for both under and outer wear, and for many domestic purposes. The well-known honeycomb counter-

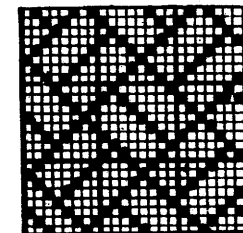

FIG. 208.

panes and toilet covers are so named from the almost exclusive adoption of honeycomb weaves, as elements with which is developed the ornamentation peculiar to those fabrics, which

ornamentation is usually of an angular and linear geometrical character.

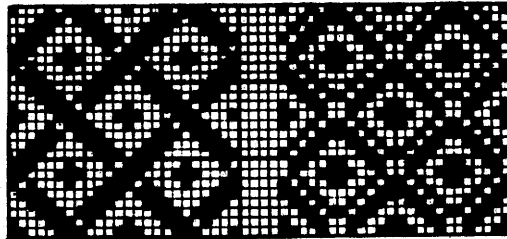

FIG. 209.

FIG. 210.

Although the peculiar effects of honeycomb weaves are primarily due to the particular methods of interlacement of

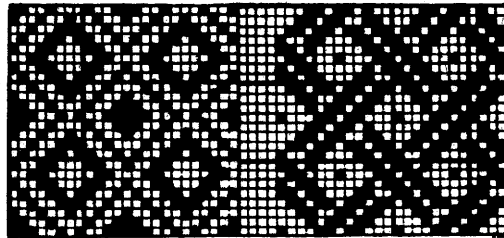

FIG. 211.

FIG. 212.

warp and weft, those effects are relatively more pronounced in compact textures produced from coarse and folded yarns, than in

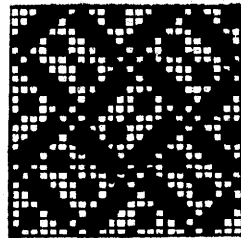

FIG. 213.

loose textures produced from fine and single yarns. For this reason it is usual to weave them from folded yarn for warp, and

G

frequently for both warp and weft, with a high number of threads per inch. The samples of cloth illustrated in Figs. 214 and 215 are very heavy textures made from threefold 8's (equal to $8 \div 3 = 2\frac{2}{3}$'s single) cotton yarn for both warp and weft. The honeycomb sample contains 32 warp threads and 36 picks per inch, and the "Brighton" sample 44 threads of each series per inch.

Whilst conformable to the same general conditions, true honeycomb weaves may vary in detail of construction, but all

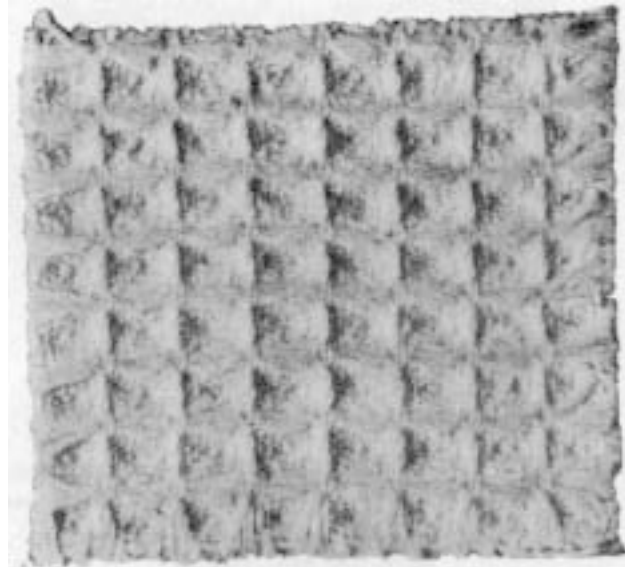

FIG. 214.—Simple honeycomb weave in fabric of coarse texture.

must repeat on an even number of both warp threads and picks. Sometimes they are made to repeat on the same number of threads each way, and sometimes on a less number one way than the other, according to the ratio of warp threads and picks required in the fabric. If warp and weft are to be in equal quantities, the weave selected should repeat on the same number of threads of each series; but if one series of threads is in excess of the other, the pattern should repeat on such number of threads each way as most nearly corresponds to the ratio of

warp threads and picks per inch, otherwise the honeycomb cells would not be square in cloth.

Fig. 216 is the simplest example of a true honeycomb weave. The pattern repeats on six warp threads and four picks, with warp and weft on the face, and therefore at the back, in equal quantities, thereby causing both sides of cloth to be exactly alike—a feature not attainable in honeycomb weaves repeating on the same number of threads each way, in which either warp or weft must slightly preponderate. In the larger weaves, however, the difference is scarcely, if at all, perceptible.

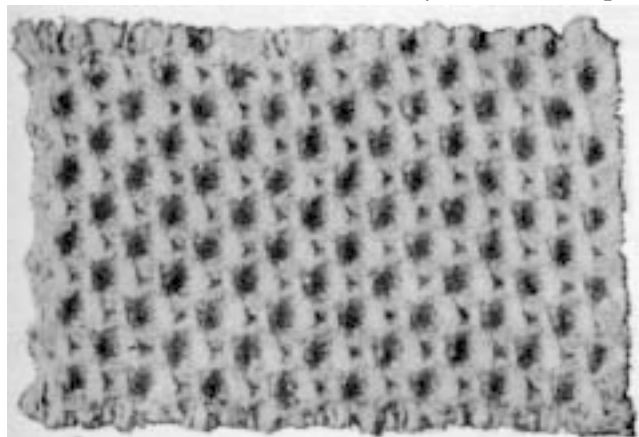

Fig. 215.—“Brighton” honeycomb weave in fabric of coarse texture.

Figs. 217A and 217B are designs showing the obverse and reverse sides respectively of the six-end honeycomb weave. As seen at 217A it appears as a simple six-end diamond weave, with alternate divisions, diagonally, filled in with a small warp diamond. The pattern is contained on $6 \times 6 = 36$ small squares, fifteen of which represent warp, and twenty-one represent weft. At 217B, however, which is the reverse of 217A, the ratio of visible warp and weft is also reversed. This variation will cause the cellular formation to be more pronounced, and therefore superior, on one side, according to the respective counts of warp and weft and the ratio of warp threads and picks per inch, which data should be known to a designer to enable him to

decide how to display the weave to the best advantage. For example, if a fabric were to be made with the same number of warp threads and picks per inch, from warp of slightly finer counts

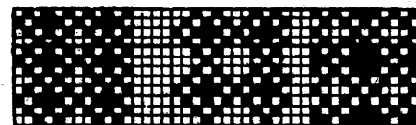

FIG. 216. FIG. 217A. FIG. 217B.

than that of weft, the best results would obtain from the weave shown at 217B, by reason of the longer float of finer warp compensating for the shorter float of coarser weft. If, on the other

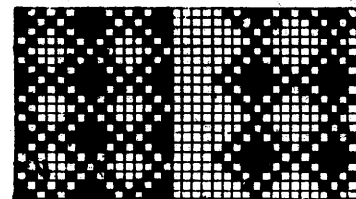

FIG. 218. FIG. 219.

hand, weft is to be a little finer than warp, the weave as given at 217A would give the best results, for similar reasons.

All other varieties of simple honeycomb weaves are constructed

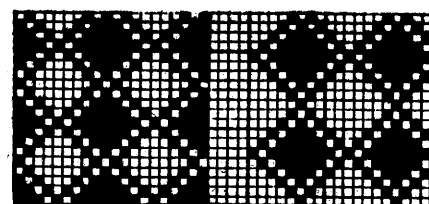

FIG. 220. FIG. 221.

in a similar manner to those given in Figs. 216, 217A and 217B, the difference being one of magnitude only. For example, Figs. 218 to 223 are honeycomb weaves of all sizes, from that contained on eight by six, to that contained on twelve by twelve threads. It is rarely that the latter size of honeycomb weave is

exceeded, excepting in fine textures containing a comparatively high number of warp threads and picks per inch. As the weaves increase in size, the threads are proportionately less frequently interlaced, thereby producing a weaker texture. It is advisable, therefore, to construct the larger weaves on the basis of what is termed a double-stitch diamond, as shown in Fig. 224, which

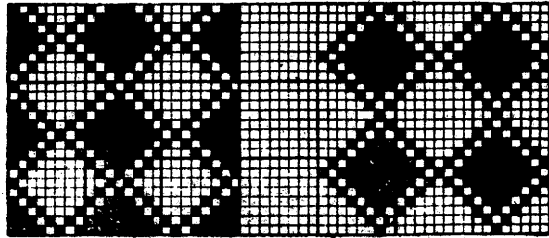

FIG. 222.

FIG. 223.

forms the basis of the sixteen-end honeycomb weave given in Fig. 225. By thus increasing the degree of interlacement of threads, a fabric of firmer texture is produced without destroying the salient features of the honeycomb weave.

At the outset of these observations on the construction of diamond weaves, it was stated that their diamond formation

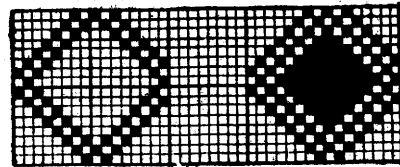

FIG. 224.

FIG. 225.

may be more or less pronounced, or even entirely obscured, as in honeycomb and similar weaves, which are characterised by a more or less distinct cellular formation. This is easily observed in Figs. 214 and 215. In the former, which is a twelve-end honeycomb weave proper, the rectangles are of uniform size, whilst in the latter, which is a twelve-end "Brighton" weave, the rectangles are of two sizes, a large and small one alternately, both longitudinally and transversely. In neither case is their diamond

origin apparent, nor is there any resemblance between the woven effects and their respective designs (as represented on design paper), as is usual with most weaves. The cause of this phenomenon will be understood on reflecting that warp and weft cross at right angles to each other, and that threads are more or less conspicuous according as they are interlaced in a lesser or greater degree respectively. Thus it comes about that the ridges of honeycomb cells are formed by the longer floats of warp and weft, which lie uppermost, whilst the recesses are caused by threads interlacing to a greater degree in those parts. By reference to the eight-end honeycomb weave, Fig. 226, it will

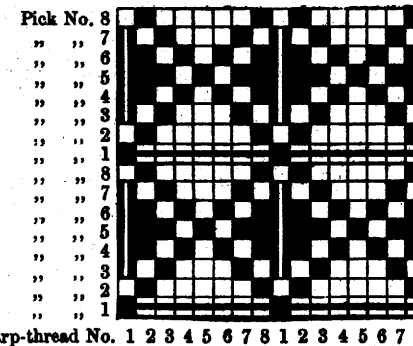

FIG. 226.—Demonstrating the cellular formation in honeycomb weaves.

be seen that the ridges of the cells are formed by the first warp thread and first pick of weft—in each repeat of the pattern—which are least interlaced, and therefore lie in a higher plane than the threads on each side of them. The threads lie in a lower plane, as their length of float diminishes, up to the fifth warp thread and pick, which lie in the lowest plane and form the recesses of the cells.

"Brighton" Weaves.

§ 42. "Brighton" weaves are also constructed on a diamond basis, yet they are quite different from simple honeycombs, and more complex in structure. They are characterised by a cellular formation comprising two sizes of cells, as seen in Fig. 215. Unlike simple honeycomb weaves, "Brighton" weaves are not

reversible, but have a totally different appearance on each side of the fabric.) Instead of clearly defined cells, as on the face of the fabric, the reverse side presents a rough, indefinite appearance, the cause of which will be presently explained. This circumstance requires to be carefully borne in mind by designers when employing "Brighton" weaves as elements in the development of ornamental designs, otherwise the designs are liable to be spoiled.

Examples of "Brighton" weaves are given in Figs. 228, 229 and 230. It is noteworthy that they may only be constructed on a multiple of four threads of warp and weft (the least size being contained on eight warp threads and eight picks, as shown in Fig. 228). They are constructed on a diamond formed by producing a simple weft twill to the right or left (for such number of

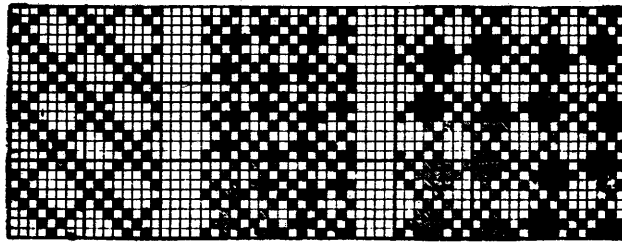

FIG. 227. FIG. 228. FIG. 229.
Construction of "Brighton" weaves.

threads as the weave is required to repeat on, say eight), and then crossing it by a double-stitch weft twill, as in Fig. 227. The next step is to put in a warp diamond spot in the right and left corners of each diamond, so as to form a weft diamond spot in the upper and lower corners. The longer floats of warp at the sides, and the longer floats of weft at the top and bottom of each diamond, form the ridges of the cells as explained in the last paragraph of § 41. The two sizes of cells are caused by the intervals between the ridges being greater and less, thereby enclosing larger and smaller areas alternately. If the relative positions of the warp and weft diamond spots are reversed, the weave will be the wrong side up by reason of the longer floats forming a *cross*, instead of a *square*, within the diamonds. A parallel reference to Figs. 230 and 231 will enable this to be easily

understood. Fig. 230 is a perfect sixteen-end "Brighton" weave with the warp and weft spots in their proper relative positions, showing the squares formed by their longer floats. Fig. 231 has

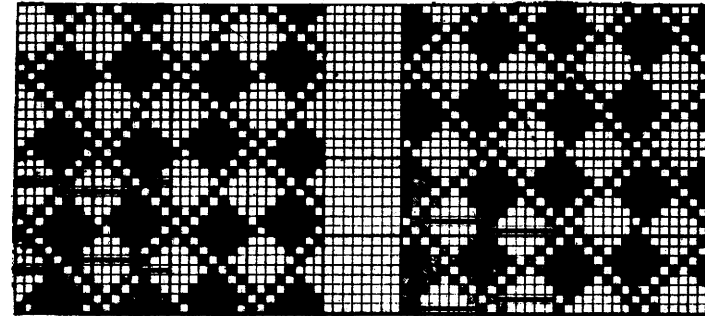

FIG. 230.—Right method. FIG. 231.—Wrong method.
Construction of "Brighton" weaves.

the same diamond foundation, but the warp and weft diamond spots are placed in the *wrong* relative positions, thereby causing their longer floats to form a cross within each diamond, as shown.

"Sponge" Weaves.

§ 43. In addition to the true honeycomb and "Brighton" weaves there is a great variety of weaves, termed "honeycomb effects," that are closely allied to those weaves, and which possess, in varying degrees, many of their characteristics. They

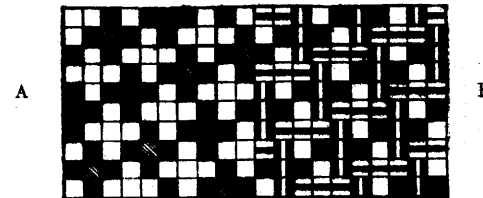

FIG. 232.—Demonstrating the cellular formation in "sponge" weaves.

are extensively employed as constructive elements in the development of Jacquard designs for honeycomb counterpanes, toilet covers and fancy woollen shawls, as well as in the production of piece-goods of comparatively heavy and thick textures

for use as ladies' winter underclothing, towels, and many other domestic purposes. They are usually characterised by a cellular formation, but of a less pronounced character than that of a perfect honeycomb. This arises chiefly from adopting a less restricted basis than that of a diamond on which to construct

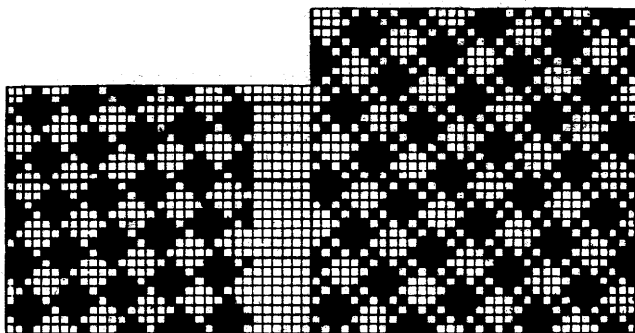

FIG. 233.

FIG. 234.

them, as, for example, a satin-weave basis, which gives a free distribution; broken diamonds; and irregular bases that cannot be exactly defined.

One of the commonest examples of these honeycomb effects is that known as the "sponge" weave (Fig. 232), contained on

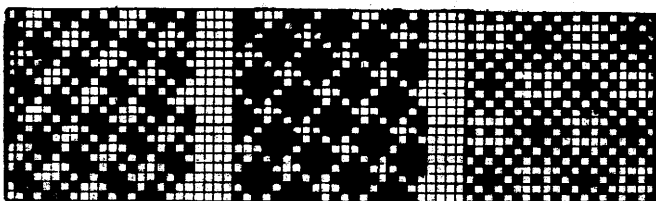

FIG. 235.

FIG. 236.

FIG. 237.

ten warp threads and ten picks. It is produced by disposing a small diamond figure or spot on a ten-end satin basis, as indicated by the shaded squares in the portion lettered A. This causes the woven fabric to assume a very neat cellular formation consisting of minute cells, the ridges of which are formed by floats of warp and weft, whilst the recesses are formed where

the threads are most interlaced. This effect is illustrated in the portion lettered B, where the warp and weft ridges are repre-

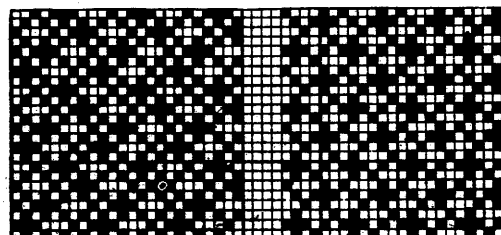

FIG. 238.

FIG. 239.

sented by white and black lines respectively, and the recesses by the enclosed spaces.

Figs. 233 and 234 are other varieties of sponge weaves on a

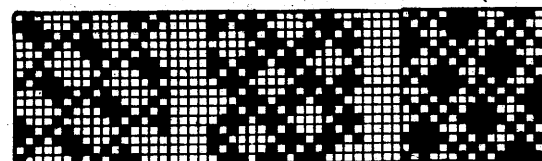

FIG. 240.

FIG. 241.

FIG. 242.

larger scale than the previous one. They are produced by arranging larger diamond spots on the basis of a twenty-six shaft, and a thirty-four shaft satin weave, respectively, as indicated by the shaded squares. Their effect in cloth is similar to that of Fig.

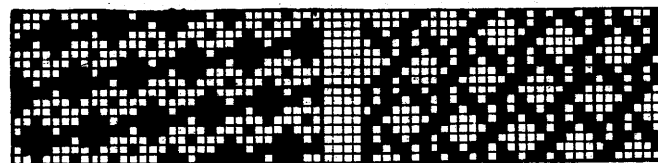

FIG. 243.

FIG. 244.

232, but with a more pronounced cellular formation, resulting from longer floats and less frequent interlacing of yarn, which enable heavier and thicker fabrics to be made by them. Figs. 235 to 244 are other examples of sponge and honeycomb effects,

and are but a few of many varieties of similar character to indicate the general principles governing the construction of that class of weaves.

“Huck-a-Back” and Kindred Weaves.

§ 44. There are many other varieties of weaves which, whilst not bearing even the slightest resemblance to true honeycomb weaves, are generally associated with honeycomb fabrics, and

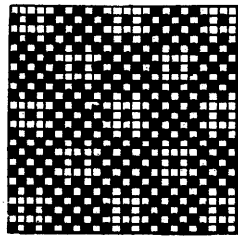

FIG. 245.—“Huck-a-back” Weave.

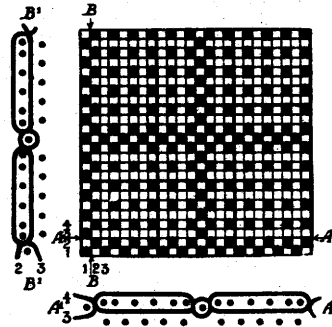

FIG. 246.

are, therefore, classed as honeycomb effects. Of this variety that known as the “huck-a-back” weave, shown in Fig. 245, and contained on ten warp threads and picks, is an example. This

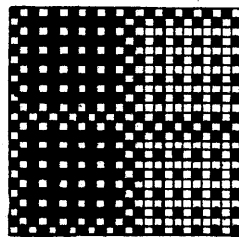

FIG. 247.—Design for “huck-a-back” cloth, Fig. 248.

familiar weave is also very largely employed in the manufacture both of linen and cotton towels for bathrooms, and also linen towels for use as glass-cloths. The principle of fabric structure embodied in the huck-a-back weave forms the nucleus of a wide

range of interesting weaves capable of producing extremely thick and heavy textures. For this reason, such weaves are generally employed as constructive elements in the manufacture of the class of heavy counterpanes commercially known as “Grecians,” usually woven from bleached twofold and threefold yarn of coarse counts for both warp and weft, and ornamented with designs of a strictly geometrical diaper character. Figs. 246 to

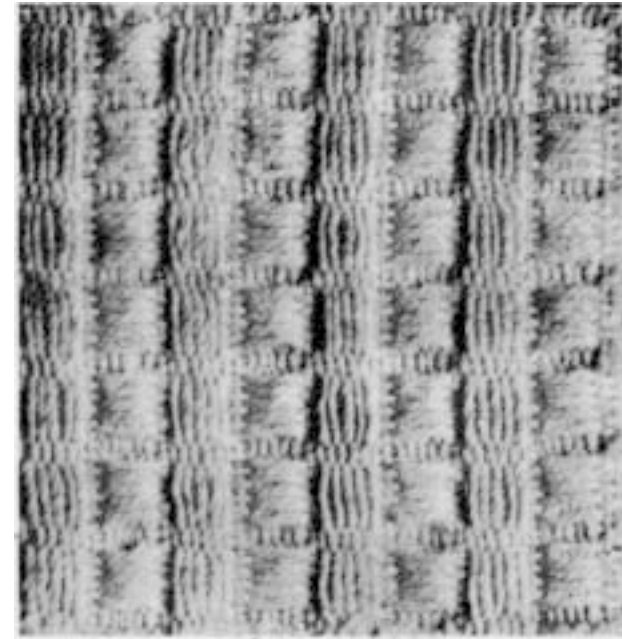

FIG. 248.—“Huck-a-back” fabric of coarse texture, from design Fig. 247

249 are three examples of weaves showing developments of the “huck-a-back” principle to form plain striped, and chequered effects respectively. In a fabric produced from Fig. 246, which repeats on twelve warp threads and picks, weft preponderates on the face and warp at the back. On examining this weave it will be seen that on the third and following odd-numbered picks to the eleventh, only the first warp thread in each repeat of the pattern is raised; also that the third and following odd-numbered

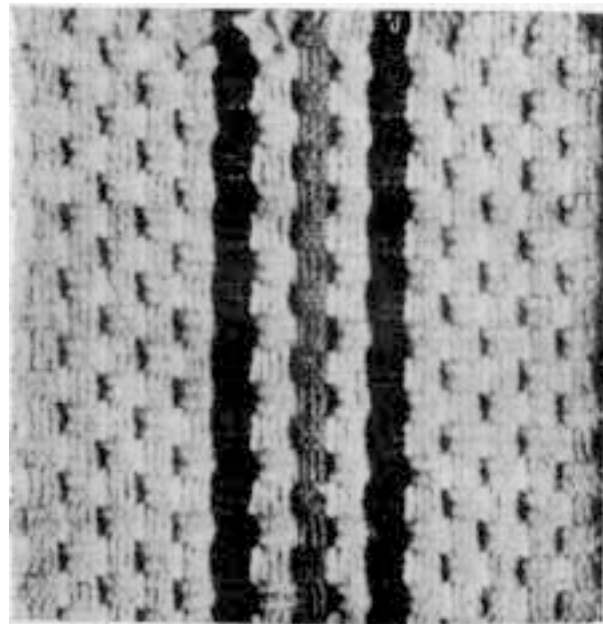
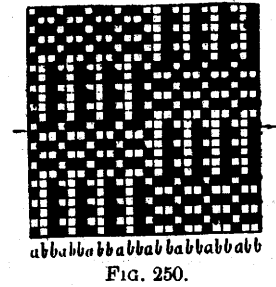
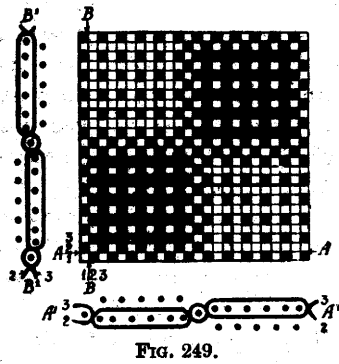

FIG. 251.—“Huck-a-back” fabric, from design Fig. 250.

warp threads to the eleventh, are raised for the first pick only in each repeat of the pattern. This has the peculiar effect of causing warp and weft threads (excepting the first of each series) to occupy four distinct planes or strata without any interlacement whatever, after the manner indicated in the accompanying diagrams, which show transverse and longitudinal sections of the weave at A, A, and B, B, respectively. It is in consequence of causing such disposition of warp and weft that weaves of this class produce bulky fabrics of great weight and warmth. Fig. 247 is a design contained on twenty-four warp threads and twelve picks, produced by counterchanging the warp and weft effects of Fig. 246 to form stripes; whilst Fig. 248 is a photograph of a woven example of the same weave produced from 3/12's warp and weft, and containing thirty-two threads of each series per inch. Fig. 249 is a design produced by counterchanging warp and weft effects of the same, weave to produce a check pattern repeating on twenty-four warp threads and picks. The diagrams accompanying Fig. 249 show transverse and longitudinal sections at A, A, and B, B, of that design as it would appear in cloth. Fig. 250 is another good example of the huck-a-back variety of designs, repeating on twenty-four warp threads and twelve picks. The photograph, Fig. 251, showing the woven effect of that design, is taken from cloth containing forty warp threads of 3/12's, and twenty of 2/14's cotton, and forty picks of 18's single cotton weft per inch. The different counts of warp are contained on separate warp beams, with the 2/14's (lettered *a* on the design) held at greater tension, during weaving, than the 3/12's (lettered *b*). Taut warp threads interweave with weft in plain or tabby order throughout; whilst slack warp threads are more loosely interwoven to form the figured effect.

“Grecian” Weaves.

§ 45. Another useful variety of weaves that are frequently associated with honeycomb and “Grecian” counterpanes, and also largely employed in the manufacture of piece-goods, are exemplified in Figs. 252 to 265. The most suitable designs for such fabrics are those based on the diaper or counterchange principle, to produce chequered effects in which both warp and

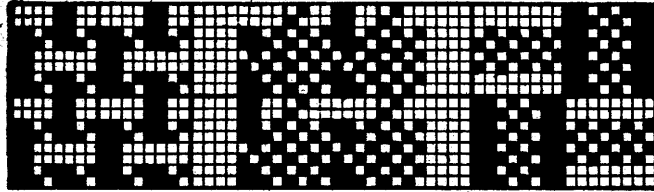

FIG. 252.

FIG. 253.

FIG. 254.

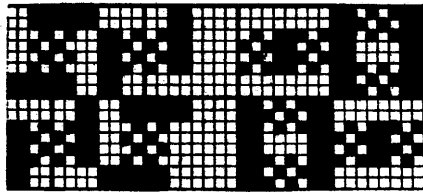

FIG. 255.

FIG. 256.

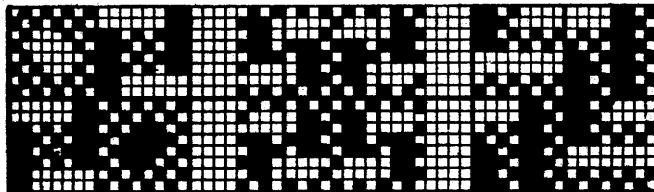

FIG. 257.

FIG. 258.

FIG. 259.

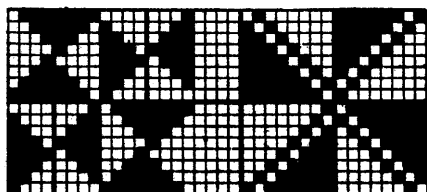

FIG. 260.

FIG. 261.

weft are freely displayed on the face side of cloth. The construction of weaves of this variety affords considerable scope for the exercise of a student's ability in fabric structure, which he should put into practical effect, and carefully note the results.

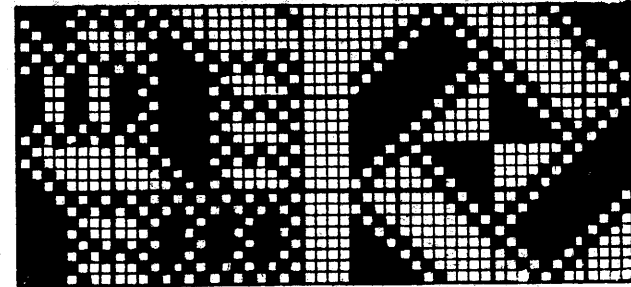

FIG. 262.

FIG. 263.

Little can be said respecting their construction, since they are conformable to no special conditions of fabric structure; but, by carefully analysing them, the means by which they are obtained will become manifest. For the general guidance of students,

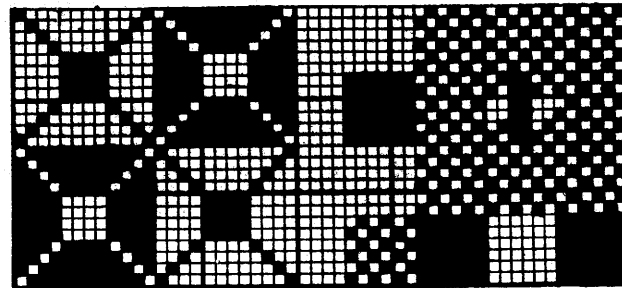

FIG. 264.

FIG. 265.

however, it should be observed that these effects are chiefly dependent either upon a suitable combination of extreme degrees of interlacement of threads, or else by causing warp threads to float over a comparatively large number of picks; and picks of weft over a large number of warp threads; otherwise, unsatisfactory results would obtain. If, for example, the

present weaves (excepting Fig. 255) were counterchanged, their effects would be lost by reason of an insufficiency of floating threads. Fig. 255 is an exception to this condition, as that weave would be equally effective whether counterchanged or not, and would, therefore, appear the same on both sides of the cloth.

Linear Zigzag or Spider Weaves.

§ 46. An interesting variety of weaves of a totally different character from any described previously under "honeycomb effects," but closely related to them, are those in which some threads, usually of weft, are pulled in opposite directions at different points, thereby causing them to deviate from their

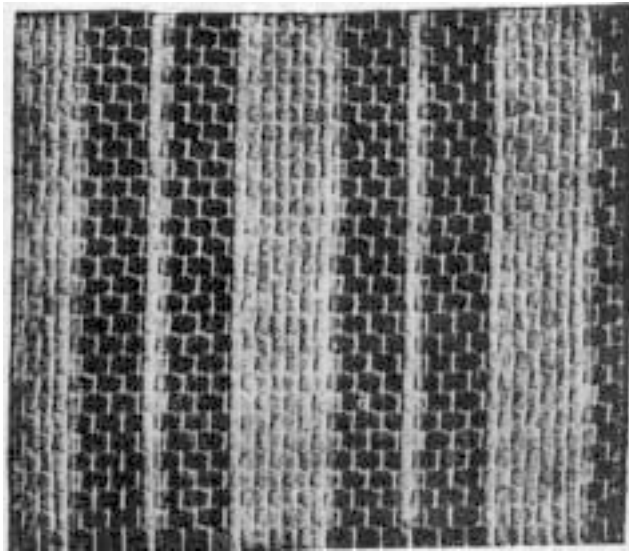

FIG. 266.—"Linear zigzag" effect, from design Fig. 267.

original straight line, and to assume sinuous lines of a more or less wavy or zigzag character, not unlike that of a "net" leno effect, produced by means of a "doup" or "leno" harness. The threads required to perform that peculiar function may be waved in the same direction uniformly, to produce a series of parallel

H

waves, or they may be waved in opposite directions to produce diamond, lozenge, ogee, and other simple linear effects, as seen

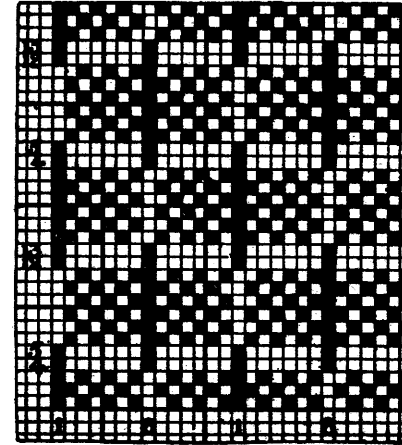

FIG. 267.—Design for "linear zigzag" effect in Fig. 266.

in Figs. 266 and 274, which are reproduced from actual examples of cloth. This phenomenon of fabric structure occurs in obedi-

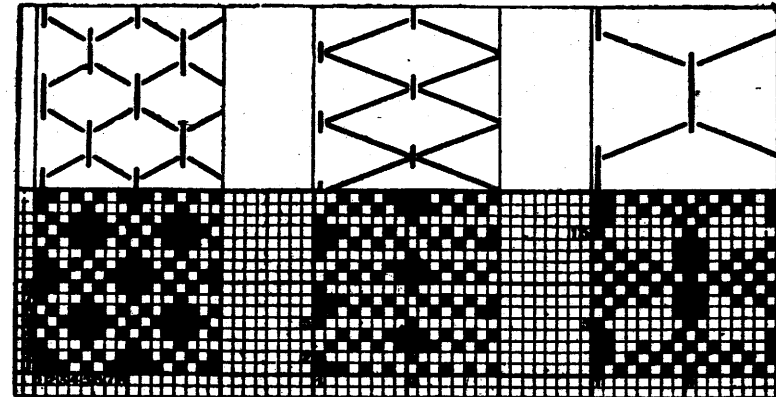

FIG. 268.

FIG. 269.

FIG. 270.

ence to the law of bodies yielding in the direction of least resistance, and forms an interesting and instructive study of the

behaviour of threads in textile fabrics. By taking advantage of the opportunities it affords, a great variety of very pleasing decorative effects may be developed in cloth, the character of which effects is chiefly dependent upon the relative density or compactness of different parts of a weave, and upon the particular manner of interlacing the threads. Thus, by so developing a weave that warp and weft are more thoroughly interwoven, and therefore more compacted, in some parts than in others (and by observing such other conditions as to the manner of interweaving as will contribute to the desired effect), it will cause some threads to pass from the denser towards the less compact

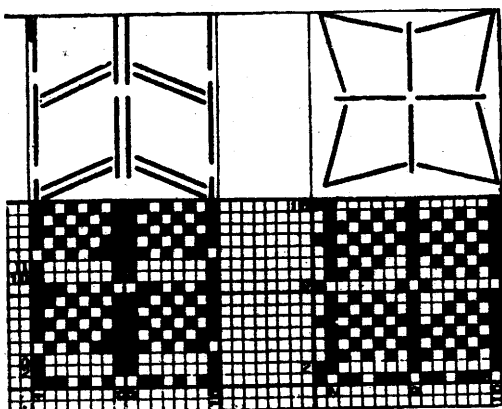

FIG. 271.

FIG. 272.

portions, and so become more or less diverted from a straight line, in proportion to the relative density of threads in those parts. These remarks will be easily comprehended after carefully studying the present examples of these weaves, in conjunction with their accompanying diagrams illustrating their effects in cloth. Weaves of this character (which, as a means of identification, may be aptly described as "linear zigzag" or "spider" weaves) are sometimes produced on a small scale in light cotton and silk textures for ladies' summer attire. They assume a more vigorous character, however, when developed with coarser material to produce heavier textures (as honeycomb and "Grecian" counterpane, and similar fabrics), and by densely

crowding that series of threads which are required to perform the bending. Thus, if *weft* threads are required to assume a zigzag course, a more pronounced effect will result from a high ratio of picks per inch, and from a high degree of tension upon warp threads during weaving. If, on the contrary, *warp threads* are required to bend out of a straight course, they should be more numerous than picks, and held at less tension; whilst the tension of weft, as it leaves the shuttle, should be

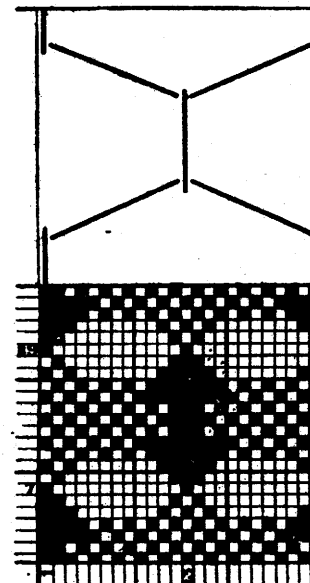

FIG. 273.—Design for fabric, Fig. 274.

increased. It should be observed, however, that better zigzag effects are produced with weft than with warp, as warp threads may be held at greater tension during weaving, which enables a relatively greater number of picks to be inserted in cloth.

Figs. 266 to 276 are examples of "linear zigzag" weaves, with diagrams showing their woven effects placed immediately above them to facilitate comparison. Fig. 266 is a full-scale photograph of a sample of light zephyr cotton dress fabric of the plain or calico weave, on which are developed a series of

linear figures of hexagonal formation similar to that above Fig. 268. The cloth is woven from the design Fig. 267, contained on fourteen warp threads and sixteen picks, and has ninety warp threads and seventy-six picks per inch. The floating warp threads, numbered one and eight on the design, which pull at opposite sides of the floating picks numbered four, five, twelve, and thirteen, are of stronger yarn than the other warp threads; the counts being

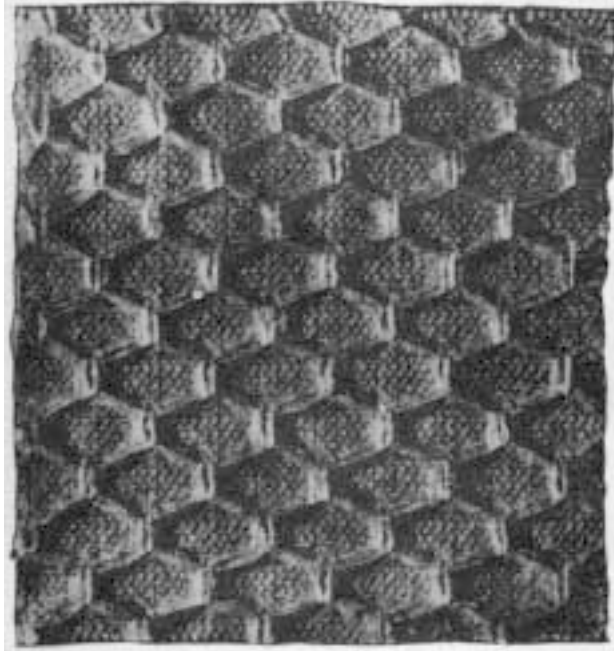

FIG. 274.—“Linear zigzag” effect, from design Fig. 273.

2/60's and 40's T. respectively; whilst the weft is 40's counts throughout. There is little or no resemblance between the design and its woven effect; but a little consideration will enable those previously unacquainted with this class of weaves to understand the cause of that difference. It will be observed that picks numbered four, five, twelve, and thirteen do not interweave with warp threads, but simply lie above them all, excepting those numbered one and eight, which always overlap those picks

from opposite sides. The floating picks, therefore, form no integral part of the fabric; for during weaving, the adjacent picks close in, so that warp threads which appear to float over ten picks in the design, float over only six picks in cloth. Thus, in consequence of being overlapped by those warp threads, the floating picks are pulled in opposite directions out of their previous

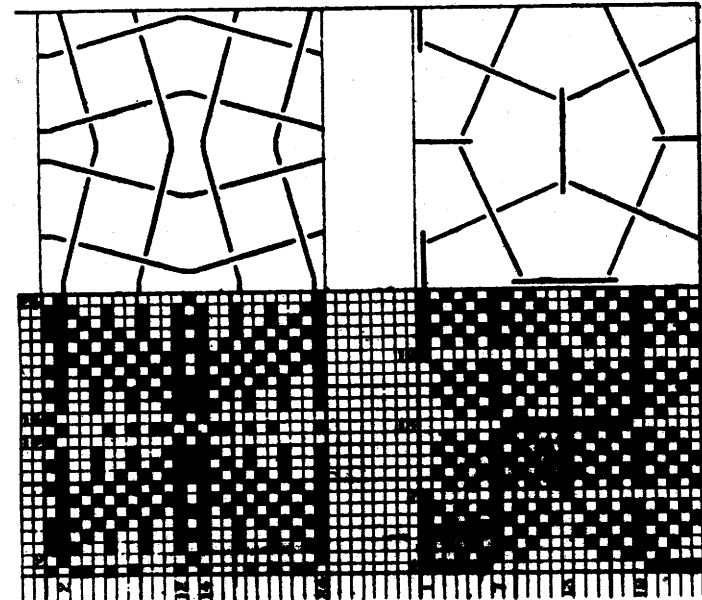

FIG. 275.

FIG. 276.

straight line, and produce the linear zigzag effect seen in the cloth.

Figs. 268 to 276 are examples of linear zigzag weaves based on this principle of weaving, and are sufficient to indicate the variety of effects which it affords. Fig. 274 is a full-scale photograph of cloth woven from the design, Fig. 273, which repeats on twenty-four warp threads and picks. The cloth contains thirty six warp threads and picks per inch of 3/16's yarn throughout, which produces a somewhat bold effect.

Crêpe or Oatmeal Weaves.

§ 47. A very useful variety of simple weaves are those embodied in a certain type of cotton textures known in the trade as "crêpe" or "crape," and sometimes described as "oatmeal" fabrics, so called from their somewhat rough and speckled surface, as illustrated in Fig. 277, which represents a typical example of a cotton crêpe fabric of good quality and medium weight and containing fifty-six warp threads and fifty-six picks of weft per inch, of 18's counts of yarn for both warp and weft, but with the warp yarn spun with a little more twist than the weft, to

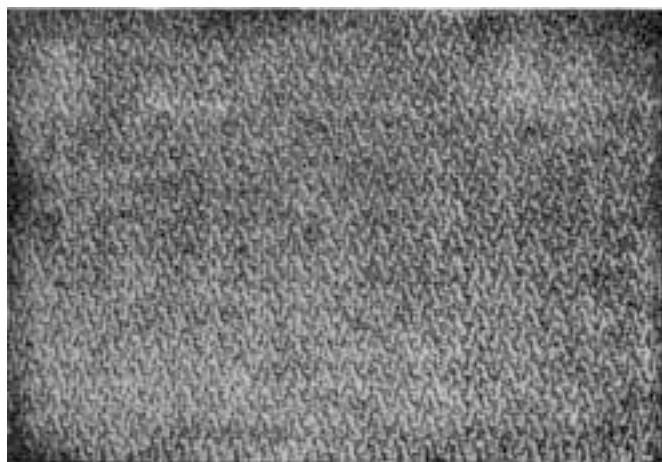

FIG. 277.—Crêpe effect, from design Fig. 276.

increase its strength. Crêpe weaves are frequently employed in conjunction with other elementary weaves, in order to produce a variety of different and contrasting effects in elaborate Jacquard designs for brocade and similar fabrics. They are also employed in the production of cotton piece-goods that are usually woven in the grey state, to be afterwards bleached and used for a variety of domestic purposes. Crêpe fabrics are also sometimes printed with decorative designs, and sold as a light and cheap material known as "cretonne," which is employed

extensively as loose coverings for furniture; also antimacassars, covers, curtains, hangings, and for many other similar household articles. Cretonnes are usually printed on both sides of the fabric, with a design and colour scheme of a different character on each side, to make them quite reversible.

The manufacture of crêpe or oatmeal fabrics permits of a wide scope of variation according to the particular character of texture required, and also the special uses for which they are intended. Thus, they are produced in relatively light, medium, and heavy textures from single and folded yarn, either for warp threads only or for both warp and weft. In some, the warp threads only are taped in pairs, whilst in others both warp and weft threads interweave in pairs uniformly. Also, both the warp and weft in some crêpe fabrics are of the same counts of yarn, but with the warp threads a little harder spun than the weft, and with the same number of warp threads and picks of weft per inch. The majority of these fabrics, however, are produced from warp yarn of finer counts than the weft, which is usually soft spun to produce a roving or a condenser weft to serve as a better filling material, but they usually contain about the same number of warp threads and picks of weft per inch.

The development of crêpe weaves affords a fair amount of scope in the creation of textural effects in cloth, but their construction, however, is not based upon any definite scheme of interlacing warp and weft threads, nor are they governed by any systematic distribution of the intersections of those threads such as those governing the construction of satin, diamond, honeycomb, and almost every other variety of elementary weaves. In fact, the more effectually the scheme of interlacement is obscured, the more completely successful will be the crêpe or oatmeal effect produced. This object is attained by an irregular distribution of the floats and intersections of the warp and weft threads in such a manner as will prevent the occurrence of stripes and lines in any direction, and also by interweaving *all warp threads* in an equal degree in order to ensure the same amount of tensile strain upon all those threads, uniformly, during weaving. Otherwise if warp threads are of unequal tension, they will tend to create more or less conspicuous

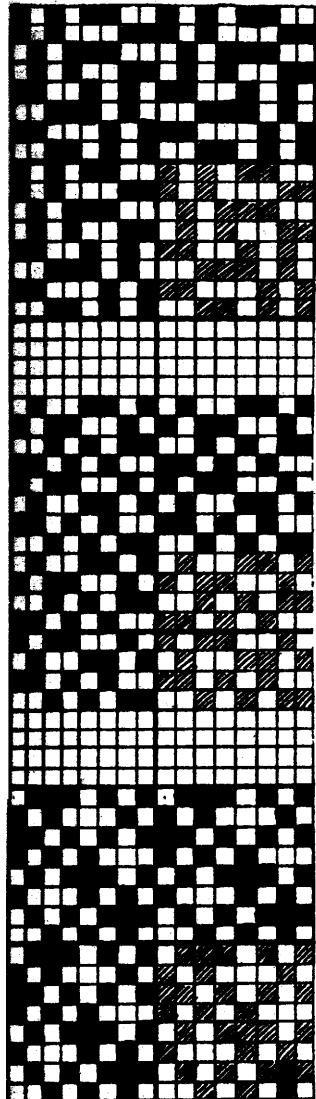

FIG. 278.—Design for crêpe effect
in fabric, Fig. 277.

FIG. 279.

FIG. 280.

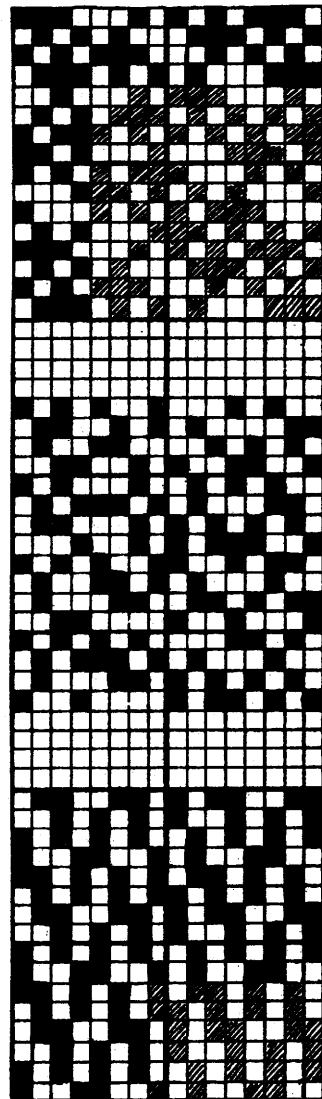

FIG. 281.

FIG. 282.

FIG. 283.

blemishes in the cloth produced, in consequence of the taut and the slack threads pulling unequally. Also it is usual, when evolving crêpe designs, to indicate the warp and weft in equal parts, on the design or point paper, in order to develop a fabric with both sides exactly alike and therefore reversible. But since these fabrics are usually produced from weft which is both softer spun and also of coarser counts than the warp yarn, the weft series of threads will, in these circumstances, predominate over, and almost obscure the finer warp threads, and thereby produce what is virtually a weft surface on both sides of the cloth.

§ 48. Examples of seven typical crêpe weaves from actual specimens of cloth are indicated in Figs. 278 to 284, which will serve to demonstrate the general character of these weaves and also the method of their construction. Thus, Fig. 278 is the design for the sample of crêpe fabric illustrated in Fig. 277, repeating on eight warp threads and eight picks of weft. This is a very popular example of a crêpe weave which gives a good effect in cloth; and although it is precisely the same design as the "sponge" weave indicated in Fig. 238, if it is woven with warp and weft of single yarn, as in the example of cloth here illustrated, it produces a more subdued effect in cloth, without the cellular formation which characterises "sponge" effects, which may only be developed successfully by employing folded yarn for both warp and weft. The crêpe weave indicated in Fig. 278 also bears a close resemblance to the eight-end "Brighton" weave indicated in Fig. 228; but a comparison of these two weaves will reveal a difference between them, and one which, to a textile designer, will explain the very different results which those weaves produce in cloth. Thus, in the "Brighton" weave, the disposition of warp and weft floats are such as to develop a distinct cellular formation of a honeycomb character, as explained in § 42; whereas the disposition of the warp and weft floats in the crêpe weave indicated in Fig. 278 is such as to produce a more even surface without the cellular appearance referred to.

The crêpe design indicated in Fig. 279 is another good example of this class of weaves also repeating on eight warp

threads and picks. In this example, the intersections of warp and weft threads are of a more irregular and indefinite character than in the previous design, of which the specimen of cloth contains forty-four taped or double warp threads (*i.e.*, eighty-eight single threads) of 2/40's yarn, and forty-four double (eighty-eight

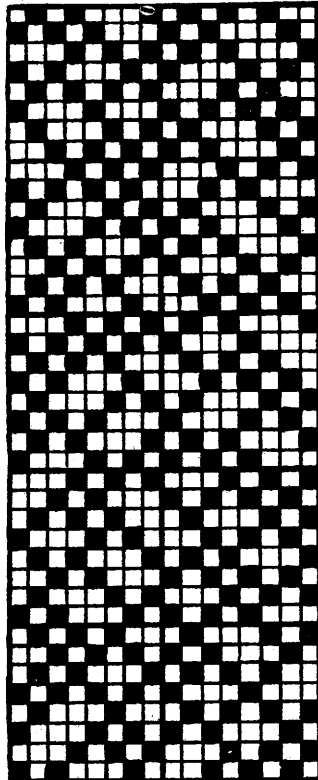

FIG. 284.—Design for "oatmeal" crêpe effect, Fig. 285.

single) picks of 20's soft weft per inch. Also, on inspecting the design given in Fig. 279, it will be seen that the first four and the last four picks are an exactly reverse counterchange of each other.

A third example of a crêpe or "oatmeal" weave is that indicated in Fig. 280, repeating on eight warp threads and picks

of weft. This is a very good weave which produces an excellent "oatmeal" effect with a somewhat rough or broken surface, especially if produced from both warp and weft of folded yarn.

Another good example of a crêpe weave is that given in Fig. 281, repeating on only six warp threads and nine picks. If produced from folded warp and weft with a high rate of warp threads and picks per inch, this weave yields a very strong and firm texture, which is employed in the corset trade.

The crêpe weave indicated in Fig. 282, which repeats on sixteen warp threads and picks, is one that is adopted for printed "cretonne" cloth, containing forty-four warp threads of 32's T. and thirty-six picks of 10's weft per inch. This fabric is of medium texture and quality, and is printed on both sides of the cloth with different patterns and schemes of colouring.

The design given in Fig. 283 is from a crêpe fabric of similar texture to the specimen woven from the design indicated in Fig. 279, and is produced from similar warp and weft of the same counts of yarn with the same number of warp threads and picks of weft per inch. This design, like that indicated in Fig. 278, is also of the character of a "sponge" weave, but it produces a more even surface without developing the cellular formation which characterises true "sponge" weaves as described in § 43.

The seventh and last example of a design for a crêpe weave is that given in Fig. 284, which is of a distinctly different character from any of the previous examples and one that produces a very pronounced "oatmeal" effect in the cloth woven from it, as illustrated in Fig. 285. The "oatmeal" or speckled appearance is still more pronounced by the use of soft spun weft of coarse counts and irregular diameter to resemble "spun flake" weft, of which a short strand is seen below the sample of cloth, Fig. 285, which also exposes a few loose strands of warp and weft threads. On examining the design for this fabric it will be observed that warp and weft threads interweave on the "tab" or "shed" by raising and leaving down warp threads on the "tabby" or plain weave principle of fabric structure, whereby, say, odd-numbered warp threads only are raised above alternate picks of weft, and even-numbered threads only above inter-

mediate picks. Also, all warp threads make the same number of intersections with the picks of weft uniformly, namely, thirty; and the picks make the same number of intersections with warp threads, uniformly, namely, twelve. Further, picks

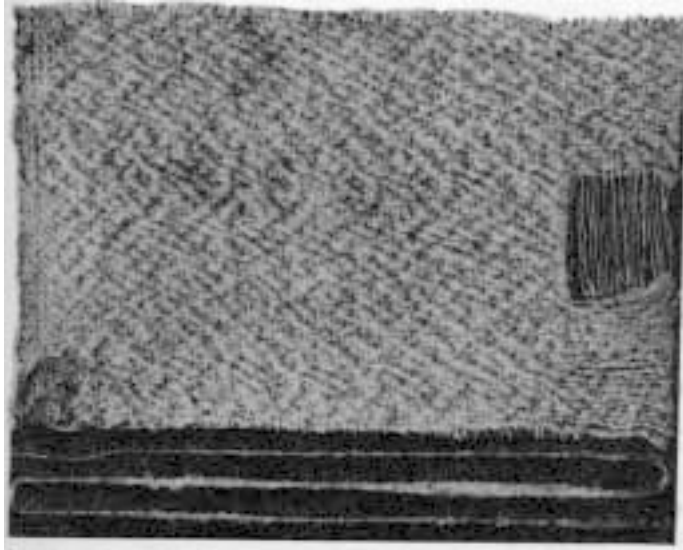

FIG. 285.—“Oatmeal” crêpe effect, from design Fig. 284.

of weft never float over more than three warp threads in succession, with weft preponderating over warp in the proportion of 5 to 3 respectively, on the surface, thereby producing a one-sided and not a reversible fabric such as result from the six previous examples of crêpe weaves.

CHAPTER V.

BEDFORD CORDS.

§ 49. Bedford cords are a variety of fabrics characterised by a series of more or less pronounced plain or twilled ribs or cords, lying in the same direction as warp threads, with weft floating somewhat freely at the back of the ribs, and usually with one, two or more wadding threads (according to width of ribs) lying loosely between. They are developed by causing either *alternate picks* of weft, or *alternate pairs of picks*, to interweave with the warp threads of one rib and then pass underneath those of the next rib alternately; whilst the intermediate picks or pairs of picks pass under the first rib, and interweave with the second rib alternately. Consequently, odd-numbered picks or pairs of picks always interweave with warp threads of the same (say odd) series of cords throughout, whilst the other picks always interweave with the even series of cords. This circumstance is helpful for the purpose of producing stripes of solid colours by picking with corresponding colours of weft in such manner that they only interweave with warp threads of the same colour, and float underneath those of the other colour. These features are clearly discernible in the photograph (Fig. 286), which shows the obverse and reverse sides of the same cloth.

Bedford cords are produced in a variety of both cotton and worsted textures, varying from light to relatively heavy cloths, according to the particular use for which they are intended. The lighter and medium fabrics are chiefly used as ladies' dress materials; whilst the heavier and coarser fabrics are generally made up into men's clothing of a special character, as fancy vests, breeches, military, sporting and riding suits, and such like. The lighter cotton textures are usually bleached, or else dyed in tints of some light and bright hue, for ladies' light summer and

holiday clothing. Generally speaking, Bedford cords afford little scope for variation of structure. This, however, is compensated for by the fair scope they offer to simple decorative effects, either by means of variegated cords, coloured threads of warp, or Jacquard weft figuring of an elementary and bold character, and consisting preferably of small detached sprigs or simple geometrical forms evenly distributed in such manner as to ensure that

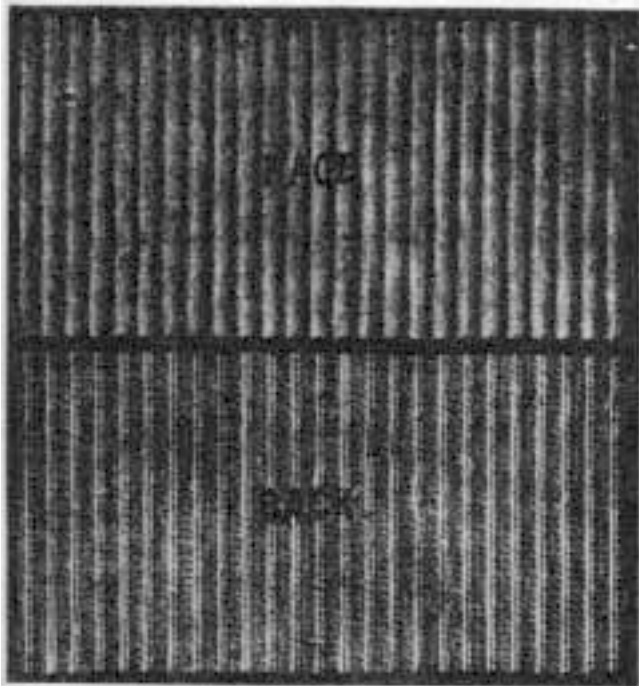

FIG. 286.—Bedford cord fabric, woven from design Fig. 291.

all warp threads shall bear the same degree of tension. Coloured threads may be introduced either as extra or crammed warp threads for figuring purposes, or in substitution for ordinary warp threads for coloured effects only. When Jacquard figuring is adopted in Bedford cords, it is virtually a system of brocade weft figuring with a Bedford cord for a ground filling.

For the purpose of giving the ribs or cords greater prominence

and also to increase the weight, bulk and strength of the fabric, one, two or more extra warp threads are sometimes introduced in each cord to serve as wadding. These extra threads never interlace with weft, but lie perfectly straight between the ridges of their respective cords and the floating weft at the back. In addition to wadding threads, some of the heavier fabrics for men's clothing contain backing warp threads that interweave with weft at the back of the cloth only, thus forming a series of tubes along which wadding threads lie straight, and which considerably increase the stability and warmth of the fabric. With few exceptions wadding threads are of considerably coarser counts of yarn than the principal or face warp threads, and since they never interlace with weft, but remain straight, their contraction during weaving is *nil*. This circumstance necessitates their being wound upon a separate warp beam, and held at greater tension than face warp threads during weaving.

It may be observed, at this juncture, that Bedford cords of low quality and somewhat open texture are usually woven face downwards, so that fewer healds require to be raised; thereby requiring less motive power to drive the loom, and reducing the wear and tear of healds and shedding mechanism. These considerations, however, are sacrificed in the production of superior qualities which are woven face side upward to permit of the readier detection of broken warp threads, and other faults liable to occur during weaving.

The present examples of Bedford cord weaves are of fabrics selected as typical specimens of their class from those of ordinary commerce. In all cases, both heald and reed drafting are indicated above their respective designs, with such other information as will be helpful to students; and the present chapter will conclude with an instructive table giving complete data of the manufacture of each example.

§ 50 Fig. 287 is a design of a light Bedford cord of the most elementary character devoid of wadding threads. Each rib contains eight warp threads, which interweave on the plain or calico principle with one-half of the picks of weft, thereby causing the complete design (consisting of two cords) to repeat on sixteen warp threads and four picks. The first and last warp threads

of each cord, termed "cutting" threads, interweave on the calico principle with *all* picks of weft, thereby forming a furrow or "cutting," which sharply divides the cords whilst the intervening warp threads, termed "face" threads, interweave on the calico principle with alternate pairs of picks only, and lie completely above the intermediate pairs of picks, as clearly indicated in the diagram, Fig. 288, showing a transverse section of cloth woven from the design, Fig. 287. The production of this cloth involves the employment of six heald shafts, namely, four in the rear for face threads, and two at the front for cutting threads. Warp threads are drafted in the manner indicated above the design, with four threads in each dent of the reed,

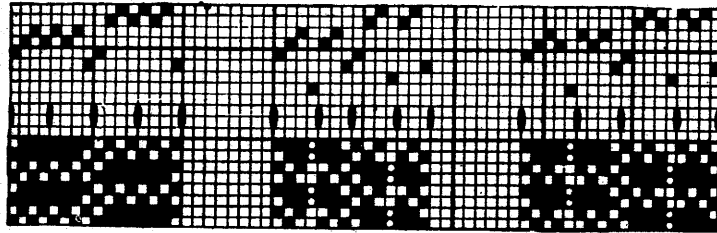

FIG. 287.—Design for Bedford cord fabric indicated in Fig. 288.

FIG. 289.

FIG. 290.

and a reed wire separating the cutting threads. Each cord, therefore, occupies two dents of the reed.

Fig. 289 differs in construction from Fig. 287 chiefly by the introduction of a wadding thread (indicated by white dots) in each cord. Wadding threads are drawn through two healds placed immediately in front of those governing cutting and face threads respectively, in accordance with usual practice. Sometimes the healds governing cutting threads are placed in front, followed by those governing wadding and face threads respectively; but this is quite optional. It will be seen that wadding threads are always raised along with all face threads of the same cords when it is required to place weft at the back; but they remain down when weft interweaves with face threads, to form the ridge of a cord, whereby they lie between the face of a cord and the floating weft.

I

Fig. 290 is similar to Fig. 289, with two additional face threads per cord, and each cord occupying two dents of the reed. Figs. 291 and 292 have two and four wadding threads in each cord, and occupy four and three dents per cord respectively. Fig. 293 is a Bedford cord occupying twenty warp threads, including eight wadding and two cutting threads drawn through five dents of the reed. Fig. 294 is a variegated cord with one broad and two narrow cords alternately. The broad cord occupies twenty-six warp threads, including four of wadding, drawn through seven dents; whilst the narrow cords each occupy eleven warp threads, including one of wadding, drawn through three dents, making a total of forty-eight warp threads for the series. Since three cords constitute an odd series, the drafting of warp threads for this design requires to be extended to include two series of cords to make an even number, and so conform to the practice, common to Bedford cords, of causing weft to interweave with the warp threads of alternate cords, and float under those of intermediate cords.

Figs. 295 and 297 are slight deviations from the previous examples, in that *alternate picks* of weft interweave with face warp threads of alternate cords, and float behind the intermediate cords; whereas, in the former examples, *two contiguous picks* either interweave or float at the same time. There is little difference between the two systems, but slightly superior results obtain with an alternate

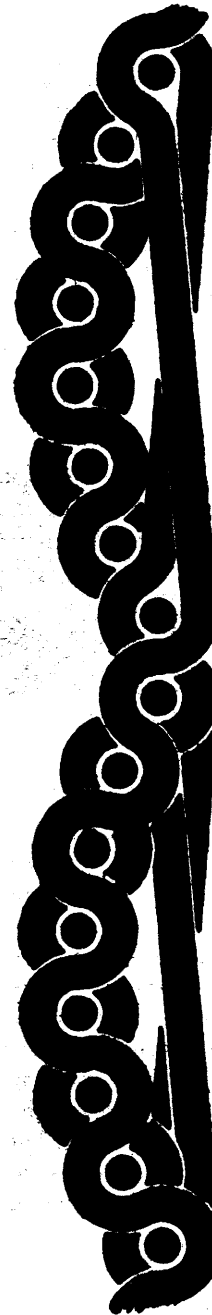

FIG. 288.—Transverse section of Bedford cord fabric, from design Fig. 287.

arrangement of picks, as these are more perfectly distributed in cloth. It is also capable of producing a closer texture, and forms a clearer cutting between the cords, which appear more distinct. Fig. 295 is an uncommon variety of Bedford cord, inasmuch as there are no cutting warp threads. The development

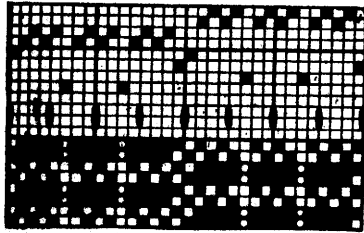

FIG. 291.—Design for Bedford cord fabric, Fig. 286.

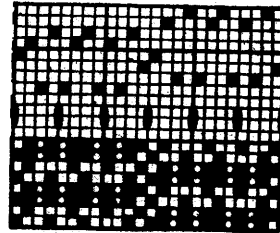

FIG. 292.

of the ribs is, therefore, entirely dependent upon each pick of weft interweaving with and floating under alternate groups of warp threads. In the present example there are eight face and two wadding threads per cord drawn through three dents of the reed. Fig. 296 is a transverse section of cloth woven from the

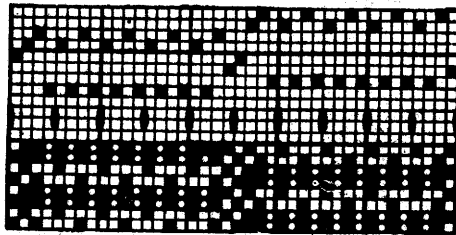

FIG. 293.

design Fig. 295. Fig. 297 is a cord similar to the previous one, but having cutting threads and a greater number of face threads in each cord, which occupies sixteen warp threads drawn through four dents of the reed.

Figs. 298 to 301 are examples of Bedford cord weaves in which the ribs or cords are developed with a three-end ($\frac{2}{1}$) twill, with alternate picks of weft interweaving with alternate cords

and then floating beneath intermediate cords; whilst the intermediate picks interweave with and then float beneath the inter-

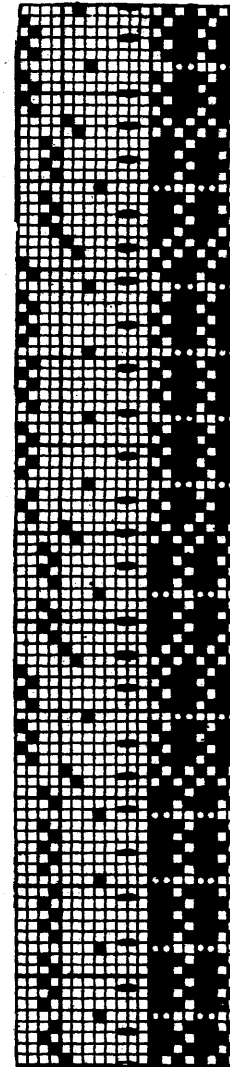

FIG. 294.—Design for variegated Bedford cord fabric.

mediate series of cords. This alternate disposition of picks appears to be uniformly observed in the production of twilled Bedford cords, whereas it obtains in a lesser degree than the two-and-two disposition of picks in the production of Bedford cords having the ribs developed with the plain or calico weave, as exemplified in Figs. 287 to 293. It is in respect of the twill weave and the uniform alternate disposition of picks that the present examples of Bedford cords differ from those previously described. These, like those, may or may not be devoid of wadding warp threads, according to the weight and character of texture required. As a rule, twilled Bedford cords are more compact and comparatively softer and more supple than the calico-ribbed variety, consequent upon a lesser degree of interlacement of warp and weft.

Fig. 298 is an example of a twilled Bedford cord devoid of wadding warp threads. Each cord occupies nine warp threads, including two cutting threads, drafted on eight healds and drawn through three dents of the reed, as indicated above the design. Fig. 299 is a twilled cord occupying six face, two wadding and two cutting warp threads per cord, drafted on twelve healds and drawn through three

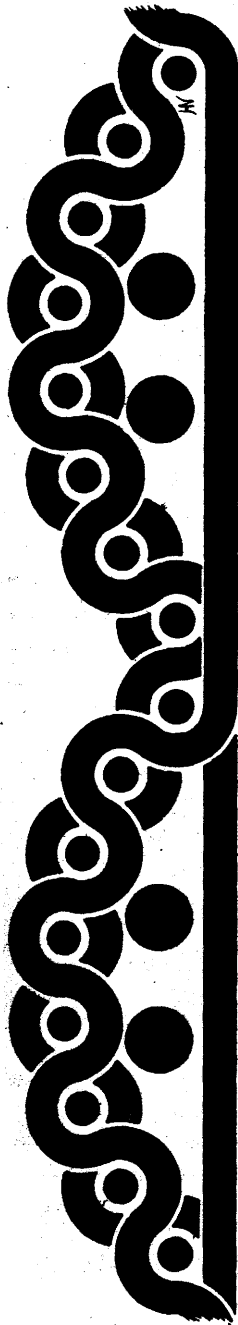

Fig. 296.—Transverse section of Bedford cord fabric, from design Fig. 295.

dents of the reed. Fig. 300 is a twilled cord occupying eighteen face, five wadding and two cutting warp threads drawn through six dents of the reed. The fabric from which this design was obtained contained six cords per inch (when in the loom), equal to 120 warp threads (excluding wadding threads) per inch. This comparatively high number of threads produces somewhat flattened ribs resembling tucks, which slightly overlap each other.

§ 51. All the foregoing examples of Bedford cords are of light and

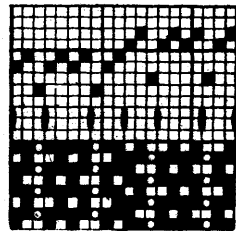

FIG. 295.—Design for Bedford cord, Fig. 296.

medium textures suitable for ladies' dress material. The two following examples, Figs. 301 and 302, are of heavy textures such as are employed for men's sporting suits. Fig. 301 occupies thirteen face, seven wadding and two cutting warp threads drawn through five dents of the reed. Fig. 302 is a full scale photograph of an interesting variety of Bedford cord of a specially heavy

and strong texture, and with wide prominent ribs. Its construction is very different in many respects to any of the previous examples. In addition to wadding threads, it contains "backing" warp threads: also picks of weft comprise two distinct series, namely (a) face and (b) back picks, inserted in the proportion

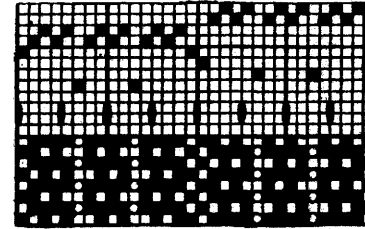

FIG. 297.

of one face and two back picks alternately. Face picks interweave with *face* warp threads of successive cords, whilst back picks interweave with *back* warp threads of successive cords, thus forming a series of tubes along which wadding threads lie straight. As indicated in the design, Fig. 303, each cord occu-

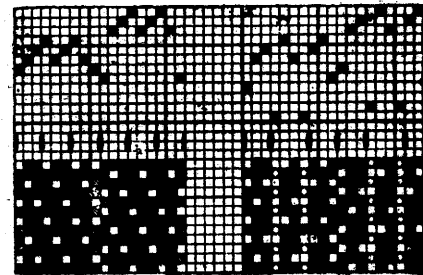

FIG. 298.

FIG. 299.

pies a total of twenty-nine warp threads, of which eighteen are "face," three "cutting," four "wadding" and four "backing" warp threads. Only two warp beams are necessary to contain the four series of warp threads, namely, one for face and cutting threads (whose rate of contraction during weaving is equal), and one for wadding and back warp threads, which are held at greater tension than face and cutting threads. Two

counts of yarn are employed in the production of this example, namely, 2/60's for cutting, and 2/16's for face, wadding and back warp threads (the latter being sized); also 2/16's weft of similar yarn to the warp threads for both face and back picks. Cutting

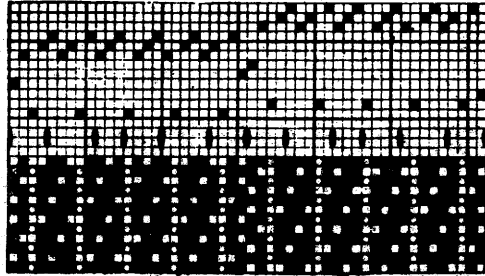

Fig. 300.

threads (represented by shaded squares) interweave in the plain or calico order with successive picks of weft. Face warp threads (filled squares) interweave with face picks only (every third pick) to produce a three-end ($\frac{2}{T}$) twill, and are raised when

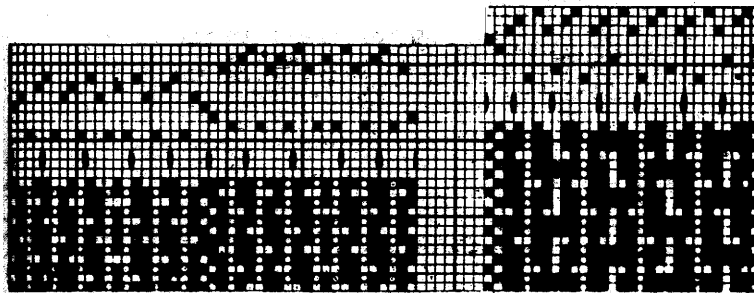

Fig. 301.

FIG. 303.—Design for
Bedford cord fabric,
Fig. 302.

back picks are inserted. Back warp threads (round black dots) interweave with back picks (two out of three) on the calico principle, but with the picks running together in pairs instead of separately. Wadding threads (round white dots) never interweave with weft, but are simply raised when back picks are

inserted, and depressed when face picks are inserted, to cause them to lie loosely between the face and back of the fabric.

§ 52. All the examples of Bedford cords described above are of a strictly plain or unfigured character. It now only remains, to make their description more complete, to describe the usual methods adopted for their embellishment. At the outset of these observations, it was stated that Bedford cords were capable of decorative treatment by means of coloured threads and by

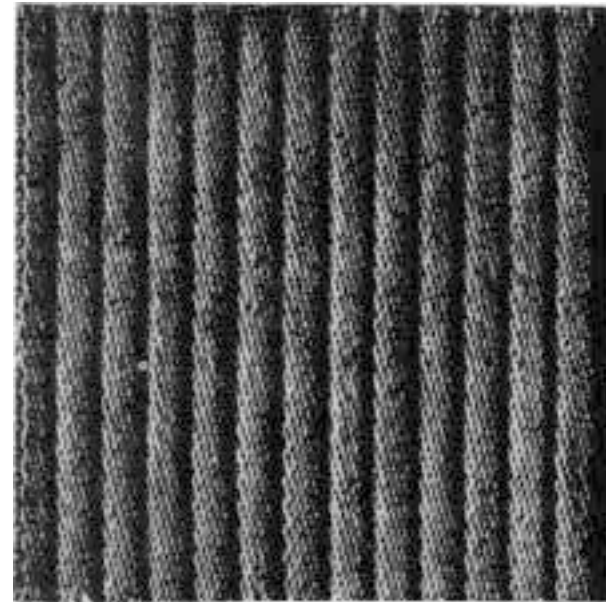

FIG. 302.—Bedford cord of heavy texture, from design Fig. 303.

simple Jacquard figuring. If coloured threads are merely substituted for undyed threads, other conditions remain unchanged; but if they are additional threads for figuring purposes, they require to be governed by extra healds. Coloured threads are sometimes substituted for wadding threads in certain cords at required intervals, and employed for the development of simple figured effects. In such instances, figuring threads do duty for wadding threads when not required on the face for figuring

purposes, with the result that they tend to impart a tinge of colour to those cords containing them. A more satisfactory method of introducing coloured threads is exemplified in Figs. 304 and 306. In Fig. 304 a neat wave stripe is developed at intervals by means of four coloured additional warp threads, represented in the design (Fig. 305) by crosses. One unit of the pattern comprises five cords, namely, a broad one containing the extra figuring warp threads, and four narrow plain ones,

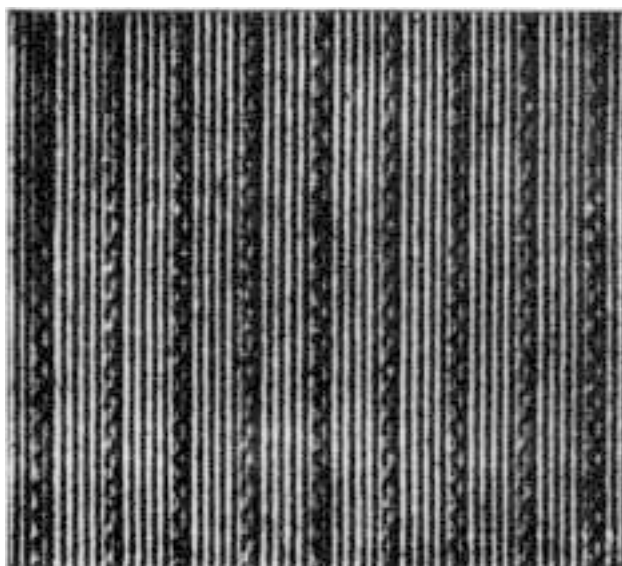

FIG. 304.—Embellishment of Bedford cord fabric by coloured warp threads, as indicated in design Fig. 305.

thereby requiring two units of the pattern to complete one repeat of the design, which must occupy an *even* number of cords. This circumstance does not prevent figuring threads in each cord from being governed by the same healds. In the present example, the extra figuring threads are governed by four healds, making a total of twelve healds disposed as follows: Four at the front governing extra figuring threads, followed by two governing wadding, two governing cutting, and four in the rear governing face threads. By drawing figuring threads

through healds placed in front, they are subjected to less strain due to shedding, since each successive heald from the front requires to be moved through a greater distance in order to maintain the proper angle of the warp shed. Warp threads are contained on three separate warp beams containing figuring, face and wadding threads respectively, with figuring threads lightly tensioned to permit of their being easily withdrawn during weaving. Another example of simple figuring by the employment of extra warp threads is illustrated in Fig. 306, showing the face and back of the same cloth. The extra threads are employed at intervals of eight cords for the development of small spots arranged alternately. To prevent figuring threads

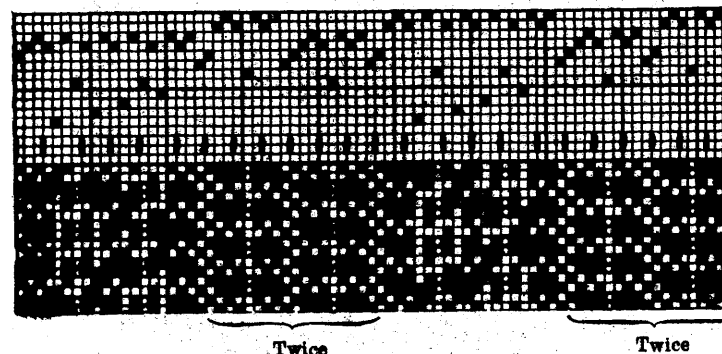

FIG. 305.—Design for Bedford cord fabric, Fig. 304.

from floating too far at the back of cloth, between any two spots, they are raised over every twelfth floating pick as indicated in the portion of design (Fig. 307).

Instead of lying at the back of cloth, as in the last two examples, figuring threads may, as an alternative method, lie with wadding threads, between the face of cloth and floating picks at the back; but if face and figuring threads are of contrasting colour, the latter will tend to impart a tinge of their colour to the whole of the cord, as stated previously.

§ 53. Fig. 308 is an example of figured Bedford cord having a simple floating weft figure developed by means of a Jacquard machine. Surrounding the figures is a ground filling of an ordinary plain-ribbed Bedford cord, each rib of which comprises

four face, two cutting and two wadding warp threads drawn through two dents of the reed. All warp threads are controlled

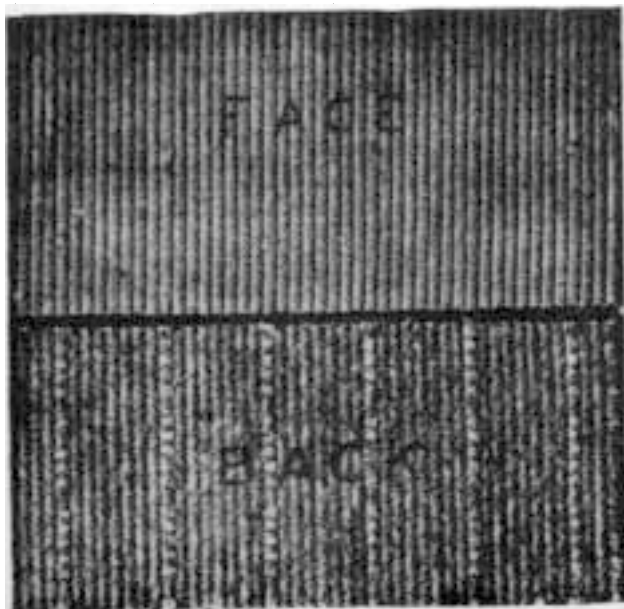

FIG. 806.—Embellishment of Bedford cord fabric by coloured warp threads, as indicated in design Fig. 807.

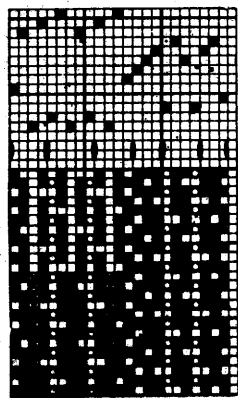

FIG. 807.—Design for Bedford cord fabric, Fig. 806.

by a Jacquard machine, but only face and cutting warp threads are utilised for the purpose of binding weft floats in the figure portions; whilst wadding threads are kept entirely at the back in those parts. This necessitates an applied design being prepared in two stages as follows: The design is first set out on design paper of the proper counts (according to the ratio of face and cutting threads and picks per inch) without regard to wadding threads, and afterwards transferred to another sheet of design paper on which wadding threads are indicated at their

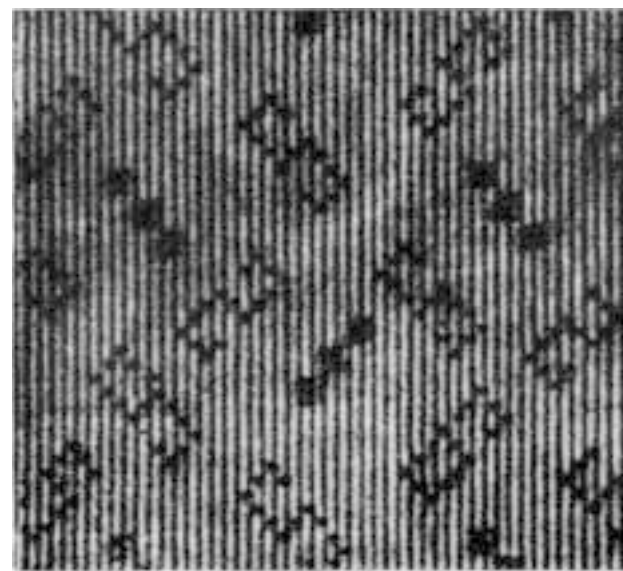

FIG. 808.—Embellishment of Bedford cord fabric by Jacquard figuring.

proper intervals. In the present case the third and sixth vertical divisions would be marked in each bar of design paper (assuming eight divisions in a bar) corresponding to the third and sixth long rows of hooks in the Jacquard machine.

§ 54. The following table gives data of the manufacture of all examples of Bedford cord fabrics described in the present chapter. The character of warp and weft yarn employed in their production is in general, normal as regards both the amount of twist and quality of yarn:—

DATA RELATING TO THE FOREGOING EXAMPLES OF BEDFORD CORDS.

Example.	Dents of Reed per Cord.	Dents per Inch in Reed.	Counts of Face Warp.	Counts of Wadding Warp.	Picks per Inch.	Counts of Weft.	Remarks.
Figs. 286 } 291 }	4	28	40's	7's	96	40's	A low-medium texture of medium quality.
Fig. 287	2	22	20's	—	72	40's	A light open texture for summer wear.
" 289	2	38	40's	2/40's	112	60's	Ditto
" 290	2	30	50's	2/30's	132	50's	A medium-weight texture of good quality.
" 292	3	40	40's	18's	112	40's	A medium-weight texture of medium quality.
" 293	5	45	40's	20's	140	50's	A heavy and close texture of good quality.
" 294	7, 3, 3	33	20's	2/12's	92	50's	A medium-weight texture of medium quality.
" 295	3	38	2/40's	2/20's	140	26's	A heavy and very compact texture of good quality.
" 297	4	32	40's	4/28's	100	50's	A light texture of medium quality.
" 298	3	28	30's	—	90	24's	Ditto
" 299	3	43	40's	2/24's	144	50's	A heavy and compact texture of good quality.
" 300	6	36	30's	2/24's	144	40's	Ditto
" 301	5	30	30's	30's	92	16's	A very heavy texture for men's clothing.
Figs. 302-3	7	27	2/16's*, 260's†	2/16's	66	2/16's	Ditto
" 304-5	3, 6†	40	44's‡	2/20's	132	50's	A medium weight texture of good quality.
" 306-7	3	40	2/40's§, 2/48's¶	2/24's	152	24's	A heavy and compact texture of good quality.
Fig. 308	2	28	40's	2/20's	100	40's	A medium-weight texture of good quality.

* Face and back warps. † Cutting warp threads. ‡ Figured cord. § Face and figuring warps. || Face warp.
 ¶ Figuring threads (mercerised) drawn through head eyes in pairs.

CHAPTER VI.
 BACKED FABRICS.

§ 55. "Backed" fabrics are characterised by an additional series either of warp or weft threads employed for the purpose of increasing their strength, weight, bulk and warmth, or any one of those properties, without affecting their surface appearance. They are largely produced in worsted textures and fustians intended for boys' and men's clothing, for which purpose they are eminently adapted, as they are capable of yielding firm and compact though soft and warm textures. Backed fabrics occupy a position midway between "simple" textures, which are composed of one series each of warp and weft threads, and "compound" textures, which contain two or more series each of warp and weft, as exemplified in all double cloths. When properly constructed, they bear no indication whatever on their surface of these additional threads, which lie entirely at the back and are, therefore, completely obscured by the surface texture. The extra series of threads introduced for "backing" may be either of warp or weft, with "face" and "back" threads arranged either alternately or in the proportion of two "face" threads to one "back" thread. If "backing" threads are of weft, it is generally coarser and of inferior quality to that employed for "face" picks, thereby requiring a loom provided with a checking motion for at least two shuttles, and a picking motion that will permit of picking (*i.e.*, propelling a shuttle) twice in succession from either shuttle-box of the loom sley; or in such other manner as is determined by the particular disposition of "face" and "back" picks. If the extra series of "backing" threads are of warp, a loom of ordinary construction without any special device will serve all requirements; also production will be increased by reason of inserting fewer picks

per inch, and a weaver will be paid a lower rate of wages than if employed on a check loom. Against these advantages, however, the extra warp threads will necessitate the use of a greater number of healds, thereby impeding the progress of a weaver when "drawing in" warp threads through healds and reed; also, in some circumstances it may be desirable to wind "backing" warp threads upon a separate beam to permit of the tension of each series of warp threads to be independently regulated to suit their different rates of contraction during weaving.

Whether "backing" threads are of warp or weft, the chief aim of a designer should be directed towards interweaving them with the face texture so as to effectually conceal their attachment when the fabric is viewed obversely. This may only be

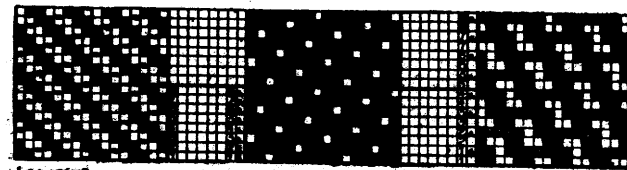

FIG. 309.

FIG. 310.

FIG. 311.—Design for fabric indicated in Fig. 312.

successfully accomplished when due regard is paid to the character of weave constituting the face texture, which should, so far as is compatible with other requirements, conform to the conditions imposed by this principle of fabric structure. If it is desired to "back" a fabric with extra weft, a design should be selected in which each warp thread passes beneath not less than *two contiguous picks* of weft (but with each warp thread under different picks) at least once in each repeat of the design. If extra warp threads are to constitute the "backing," the design should be one in which each pick of weft passes beneath not less than *two contiguous warp threads* (but with each pick under different warp threads) at least once in each repeat of the design. By adopting this expedient, suitable places are provided at which to bind or "tie" the extra series of threads to the face texture

so that the "ties" or binding points will be effectually obscured. These remarks will be easily understood on consulting Figs. 309 to 312.

Fig. 309 is a design for a four-end ($\frac{2}{2}$) twill, to constitute the face weave of a fabric to be "backed" with weft in the proportion of one "face" pick to one "back" pick—the "back" picks to interweave on the eight-end satin basis, Fig. 310. When the two weaves are combined pick and pick, they produce a design repeating on eight warp threads and sixteen picks, as shown in Fig. 311, in which filled squares represent "face" picks, and shaded squares "back" picks. The points selected for binding "back" picks into the face cloth are where a warp thread passes beneath two contiguous picks (as indicated in Fig. 309), which by lying close together above those points, entirely obscure the

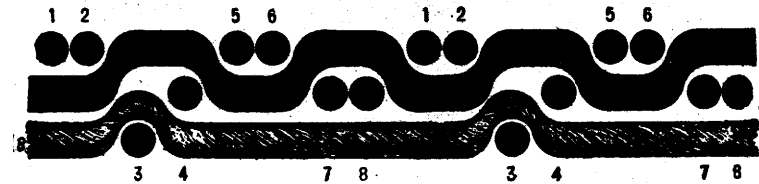

FIG. 312.—Transverse section of weft-backed fabric, from design Fig. 311.

intersections from view. It will now be perfectly clear that suitable binding places (in weft-backed fabrics) occur only at such points where the binding thread passes beneath at least *two* contiguous face picks which serve to cover those points, and that if a design is of such character that warp threads pass beneath only one face pick at a time, the binding points are liable to show on the face, in consequence of imperfect covering by face picks. It should be observed that when a back pick is inserted, all warp threads are raised excepting those which are required to pass under it for the purpose of binding it to the fabric, as seen in Figs. 311 and 312.

Fig. 312 represents the "face" and "back" picks (Nos. 1 and 1a respectively) of design Fig. 311 as they would appear in cloth when viewed transversely, and shows the "back" pick passing over the third warp thread as the latter passes *beneath*

the first and second "face" picks which close over and completely cover the binding or "tie".

In order to obtain the best results, all warp threads should, if

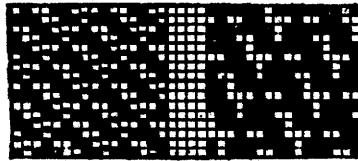

FIG. 313. FIG. 314.

possible, be utilised for binding "back" picks to the face texture, and binding points should be uniformly distributed: therefore, the nearer such distribution approaches to that of a satin basis

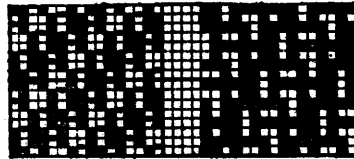

FIG. 315. FIG. 316.

the better. Many designs, however, will not permit of the employment of every warp thread for binding purposes; nor of the distribution of binding points on a satin basis. In such cases,

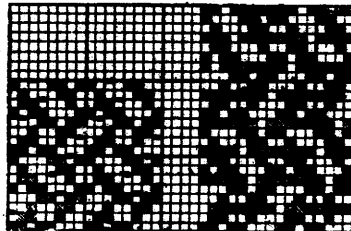

FIG. 317. FIG. 318.

a little skill is oftentimes required to make a selection of binding places that will give the best results. Hence the necessity of avoiding such impediments when preparing designs intended for this class of fabrics.

K

Figs. 313 and 314 are examples of small figured weaves for "backing" with extra weft, and show the face weaves or plans, and completed designs, separately, with the most suitable places for binding "back" picks to the face texture indicated upon each plan. Figs. 313 and 315 have the binding points arranged for

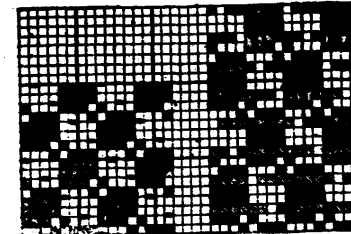

FIG. 319. FIG. 320.

an alternate disposition of "face" and "back" picks, as observed in the completed designs, Figs. 314 and 316 respectively. The weave plans shown in Figs. 317, 319 and 321 have the binding places indicated for the picks to be disposed in the order of *two* "face" picks and "one" back pick alternately, as exemplified in their respective completed designs, Figs. 318, 320 and 322.

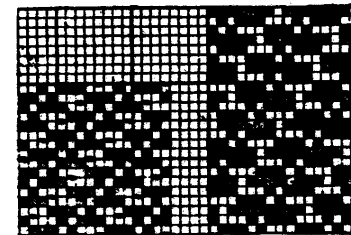

FIG. 321. FIG. 322.

§ 56. The construction of warp-backed fabrics is governed by the same principles as those which govern the construction of weft-backed fabrics, as regards the method of securing the extra series of threads to the face texture. Therefore, the binding of "back" wrap threads must occur at such places as will ensure the binding points being properly covered by "face" warp threads.

In other words, a "back" warp thread should only be raised over a pick when the latter is passing beneath two or more "face" warp threads; otherwise the binding points will be liable to show on the face of the fabric. Fig. 323 represents the face weave of a fabric to be backed with warp on the one-and-one or alternate disposition of threads, with the most suitable binding places indicated on the design, which permits of a distribution of binding points on an eight-end satin basis. Fig. 324 is the same design with "back" warp threads added, and with the heald drafting of warp threads shown above. Fig. 325 is another design for a warp backed fabric with warp threads disposed in the proportion of two

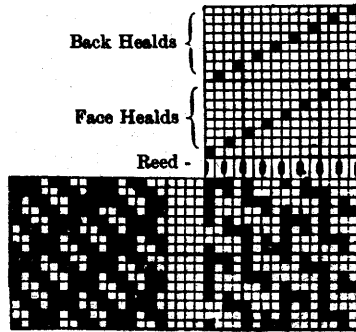

FIG. 323. FIG. 324.
Design for warp-backed fabric.

"face" threads and one "back" thread alternately, as shown in the complete design, Fig. 326, with the draft shown above it.

Warp-backed textures are usually constructed with an *alternate* disposition of warp threads to produce a superior back to those constructed on the two "face" and one "back" arrangement of threads. "Back" warp threads usually interweave with weft in a much less degree than do the "face" warp threads, thereby producing a softer back, arising from the greater length of floats. This lesser degree of interlacement of "back" warp threads results in a consequent lesser rate of contraction than "face" threads during weaving, thereby requiring each series of warp threads to be contained on separate warp beams to permit of their independent regulation for tension. "Back" warp threads

should be drawn through a set of healds apart from those governing "face" threads, and should preferably be placed in the rear of face healds, as indicated in the drafts above Figs. 324 and 326. Also, "back" warp threads should pass from the warp beam to healds in a slightly *lower* plane than "face" threads, and should not be raised quite so high as the latter during shedding. By observing these precautions, unnecessary abrasive friction and chafing of warp threads will be avoided, and any tendency of binding points to show on the face is thereby reduced.

§ 57. Another variety of backed fabrics, constructed on exactly the same principles as the previous examples, are known

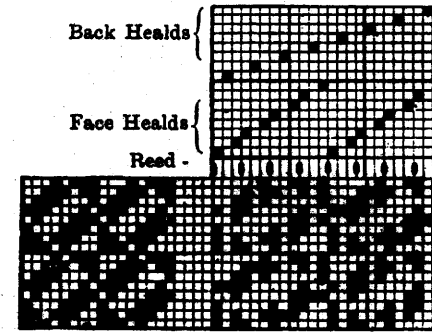

FIG. 325. FIG. 326.
Design for warp-backed fabric.

also as reversibles or double-faced fabrics, from the fact that it is quite optional which side is exposed to wear. Reversible fabrics are exemplified in some ribbons (which usually have both sides equally exposed when in wear), shawls, travelling rugs, mantle cloths, coatings, and some fustians, which may be made to present a similar appearance on both sides; or each side may be different both in respect of weave and colouring. This opportunity is often seized upon to provide mantle cloths and coatings with self-linings of a character quite different both in colouring and texture to the face or outer texture, albeit the lining forms an integral part of the fabric, which is thereby rendered heavier, thicker and warmer.

CHAPTER VII.

FUSTIAN FABRICS.

§ 58. Fustians are a well-known type of cotton fabrics comprising several varieties, the chief of which are known as "imperial," "swansdown," "canton," or "diagonal," "mole-skin," "beaverteen," "velveteen" or cotton velvet formed with a weft pile, and "corduroy". With the exception of velveteens, which simulate the real silk velvet formed with a warp pile, they are comparatively firm, heavy and compact textures of great strength and durability, chiefly employed in the production of clothing. The first three varieties embody no special constructive feature in their design, as they are based on some simple weave that permits of an abnormally high rate of picks being inserted so as to produce a compact fabric. Each of the remaining varieties, however, is characterised by some peculiar constructive element that distinguishes it from all other fabrics. These are virtually "backed" fabrics, since they are constructed from one series of warp threads and two series of weft threads, namely, "face" and "back" picks, although both series of picks are of the same kind of weft, thereby requiring for their production a loom with only one shuttle-box at each end of the sley.

Unlike all other varieties of fustian fabrics, velveteens and corduroys are characterised by a short and soft fur or plush pile closely resembling that of silk velvet. This fur-like effect is obtained subsequent to weaving by an operation known as "fustian cutting," in which certain floating picks of weft are cut or severed by specially constructed knives that are operated either manually or else mechanically, thereby causing those picks to become more or less erect and thereby expose their transverse sections to the surface, which gradually simulates the character of true velvet. In plain velveteens, short tufts of pile of uniform

(133)

length are distributed uniformly over the fabric, thereby forming a perfectly level surface; but in corduroys, the tufts of pile are caused to develop a ribbed or corded formation, with the cords produced lengthwise or parallel with warp threads. These characteristics are clearly illustrated by Figs. 327 and 328, which are reproduced from actual examples of velveteen and corduroy



FIG. 327.—Velveteen fabric (cotton velvet), before and after the operation of fustian cutting.

fabrics respectively. Each example shows a portion of cloth both before and after the operation of fustian cutting. It should be observed, however, that velveteens are sometimes made to assume a corded appearance resembling that of corduroys; but their different texture and construction enable them to be easily distinguished from the latter when the characteristics of each are known.

Imperial.

§ 59. The variety of fustians known to the trade as "imperial" comprises several modifications of what is perhaps better known as "swansdown" cloth, so called from the soft nap or downy surface produced, after weaving, by scratching up or raising the fibres composing the threads of weft, by an operation termed "perching". The nap thus formed simulates



FIG. 323.—Corduroy fabric, before and after the operation of fustian cutting.

the soft down of swans (hence its description as "swansdown") and greatly increases the warming properties of the fabric, which for this reason is largely employed for ladies' underclothing. Fig. 329 is a design for swansdown repeating on five warp threads and five picks. From the design, it would appear that weft preponderates on the face in the ratio of three of weft to two of warp, but, virtually, it gives an all-weft surface by reason of

the much greater density of picks, as compared with warp threads, which latter are entirely obscured on the face. Also, to facilitate the development of a nap by perching, a fairly soft weft of good quality is used. A good quality of swansdown contains 60 warp threads of 18's T. and 120 picks of 20's soft weft per inch.

A heavier make of swansdown, known as "imperial sateen," is produced from the design Fig. 330, repeating on eight warp threads and picks, and based on an eight-end satin weave, but with two contiguous warp threads always raised together. This weave produces relatively longer floats of weft, which latter preponderates over warp in the ratio of six to two respectively.

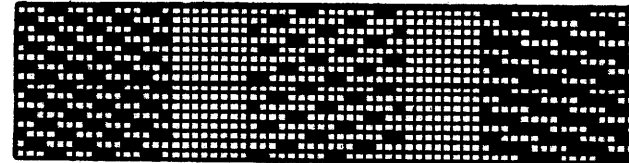

FIG. 329.—Design for "swansdown" fabric.

FIG. 330.—Design for "imperial sateen" and "lambskin" fabric.

FIG. 331.—Design for reversible sateen fabric.

Imperial sateens are sometimes dyed and finished to imitate light moleskins, with a short nap raised on the back; but when imperials are perched on the face they are named "lambskins," from their long soft woolly nap. A medium quality of dyed imperial sateen contains sixty-eight warp threads of 16's T. and 150 picks of 16's weft per inch; whilst a good quality of "lambskin" contains forty-six warp threads of 2/20's yarn and 450 picks of 20's weft per inch. A design for what is termed a reversible "imperial" contained on eight warp threads and picks is given in Fig. 331. By densely crowding picks of weft, this weave produces a very compact texture, with only weft visible on both surfaces of cloth. A good quality of this cloth contains sixty-two warp threads of 14's T. and 380 picks of 30's weft per inch.

"Cantoon" or "Diagonal" Fabrics.

§ 60. Cantoon is a variety of fustian largely employed in the production of men's riding and sporting suits, and occasionally of ladies' jackets. As with the previous examples of fustians, its construction embodies no special feature of design, but merely consists of a pick-and-pick combination of the two regular six-end twill weaves, Figs. 332 and 333, to produce the design Fig. 334, which repeats on six warp threads and twelve picks. A good ex-

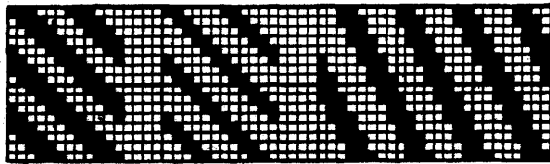

FIG. 332. FIG. 333. FIG. 334.—Design for "cantoon" or "diagonal" fabric.

ample of this cloth under present notice contains fifty-four warp threads of 2/20's yarn and 400 picks of 20's weft per inch. This abnormal density of picks produces a very strong and compact fabric having a fine corded appearance, with the cords or wales running obliquely at an angle of 18° to the picks of weft. These fabrics are usually dyed either a fawn or drab hue, and perched on the back.

Moleskin Fabrics.

§ 61. Moleskin is a smooth but thick leathery variety of fustian of greater strength and weight than other varieties, and is largely employed in the production of strong suits of clothing for iron and brass moulders, navvies and other workmen engaged in rough occupations. Its thickness and compactness of texture, combined with its smooth and even surface, make it well adapted for moulders, as it is impervious to sand, and not so easily penetrated as other fabrics by splashes of molten metal. Moleskins are produced from one series of warp threads and two series of picks (of the same kind of weft), namely, face and back picks, inserted in the proportion of two face picks to one back pick. Face picks combine with alternate warp threads

only, to produce a modified satin weave repeating on six warp threads and three picks; whilst back picks interweave with all warp threads to produce a three-end weft twill at the back, as indicated in design Fig. 335, which repeats on six warp threads and nine picks. By causing only alternate warp threads to bind over face picks, in addition to combining with back picks, there is a slight tendency to impart a little more strain upon those threads than upon intermediate threads which combine with back picks only. The additional strain upon those warp threads tends to develop a faint stripy formation in cloth, which is, however, considered to be a point of excellence.

Moleskins permit of little or no structural modification without departing from their true character. The moleskin design given in Fig. 336 shows a slight departure from the previous

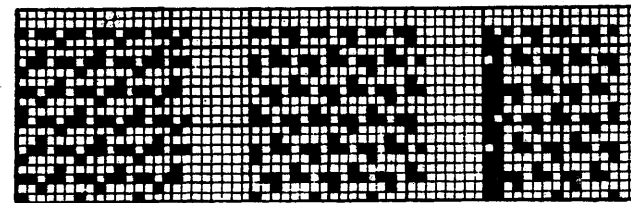

FIG. 335. FIG. 336. FIG. 337.
Designs for moleskin fabrics.

example, but one that would manifest no appreciable difference in cloth, excepting to an experienced person. In Fig. 335 it will be seen that at certain points alternate warp threads pass abruptly from above a face pick and underneath a back pick, whereas in Fig. 336 there is always an interval of one pick between the bindings of a face and a back pick by the same warp thread. For example, in Fig. 335 the third warp thread is over the second face pick and under the following, which is a back pick. The passage of warp threads over a face pick and then immediately under a back pick increases their tension and thereby tends slightly to emphasise the stripy appearance just mentioned.

Moleskins are not well adapted to decorative treatment of a structural character, but they, as well as heavy imperials, are sometimes printed with simple decorative effects to imitate worsted suitings, and employed in the production of men's

clothing. They are also sometimes woven with a simple stripe formation, as exemplified in the design, Fig. 337, which repeats on fourteen warp threads and nine picks. A moleskin fabric of good quality contains thirty-eight warp threads of $3/24$'s yarn and 400 picks of 14's weft per inch.

Beaverteen Fabrics.

§ 62. Beaverteens are virtually moleskins produced in lighter textures, that are afterwards dyed and printed and then perched on the back, to produce a short and soft nap. Fig. 338 is a design for a beaverteen contained on six warp threads and twelve picks, with three face picks to one back pick. The face weave is almost similar to the swansdown weave given in Fig. 329, and the back is a plain but not a true calico or tabby weave. All

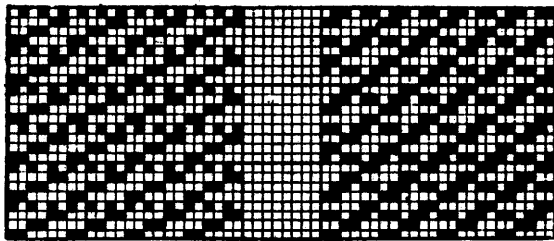

FIG. 338. FIG. 339.
Designs for beaverteen fabrics.

back picks interweave under and over consecutive warp threads, as in the plain calico weave; but alternate warp threads are raised for two out of three back picks, and intermediate warp threads weave in an opposite manner to those, namely, down for two picks and up for one. Fig. 339 is another design for beaverteen, contained on six warp threads and nine picks. It has the same face weave as the previous example, but is backed with three-end weft twill and contains only two face picks to one back pick. A good quality of beaverteen contains thirty-two warp threads of $2/18$'s yarn and 280 picks of 18's weft per inch.

Velveteen Fabrics.

§ 63. Velveteens constitute an important variety of fustians, generally of much lighter texture than other varieties. As previously stated in § 58, their characteristic velvet appearance is produced subsequent to weaving by an operation of fustian cutting (performed sometimes, for low qualities only, by machinery, but more frequently by hand) which is usually conducted independently as a kindred branch of fustian manufacturing. Previous to being cut, a velveteen fabric presents no unusual structural appearance, but has a smooth level surface with weft floating abundantly on the face, as in fabrics constructed on a simple satin basis.

Velveteens are produced from one kind of weft inserted so as to constitute two series of picks, namely, "pile" and "ground" picks, corresponding to face and back picks respectively. Pile picks are floated somewhat loosely on the surface, to be afterwards cut to form pile; whilst ground picks interweave more frequently with warp, to build up a firm foundation texture to sustain the pile. Indeed, the simplest definition of a velveteen fabric is: A simple texture of calico, twill or other simple weave, embodying a vast number of short tufts of weft (thus—U) evenly distributed to produce a soft velvet-pile surface. Thus, if all the tufts of pile were entirely withdrawn, there would still remain a perfect foundation texture of a plain, twill or other simple weave according to the basis adopted. For light and medium textures, the latter is usually based either on the tabby or three-end twill weave; and for heavier textures, on the four-end ($\frac{2}{7}$) twill weave.

It is important that pile picks should be securely attached to the foundation texture to prevent the tufts of pile being accidentally withdrawn either during fustian cutting or when the fabric is in use. This may be accomplished in two ways, namely, (a) by compression, caused by densely crowding picks of weft; and (b) by interweaving pile picks with several warp threads in succession, to produce what is termed a "fast" or "lashed" pile; or by adopting both of these methods. Most velveteens, however, are constructed on the former plan, in which pile picks are bound into the foundation texture by only one warp thread at regular intervals of six, eight or ten threads, according to length of pile

required. The second plan is usually adopted when it is required to float pile picks for a greater distance, for the purpose of producing longer pile, the tufts of which would be more liable to accidental withdrawal. Whether pile picks are bound by only one or more than one warp thread in each repeat of the pattern,

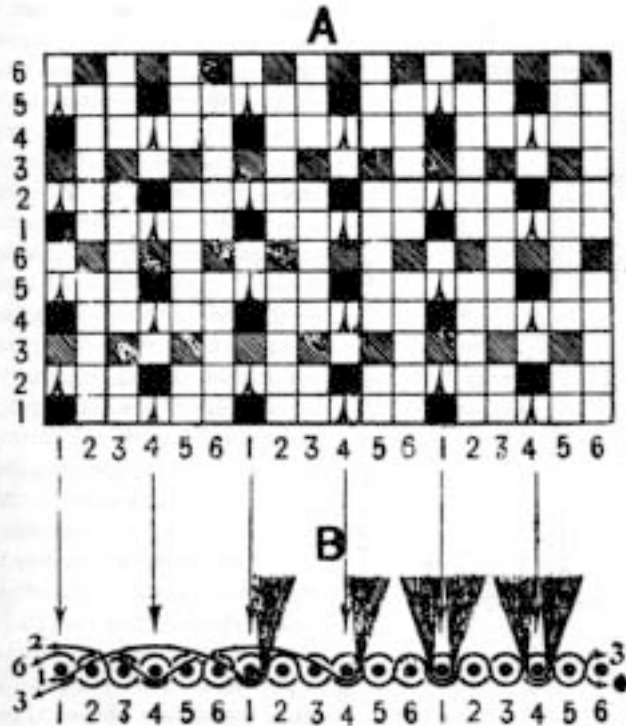

FIG. 340.—(A) Design for velveteen fabric, of which B represents a transverse section, showing certain picks of weft standing erect, after being severed by the fustian knife to form tufts of pile.

it is imperative that the binding should occur at regular intervals on each pick, to give uniform lengths of floats, and, therefore, a uniform length of pile after cutting.

§ 64. Fig. 340 A is a simple design, repeating on six warp threads and six picks, for a tabby back velveteen containing two pile picks to one ground pick, with pile picks bound at intervals

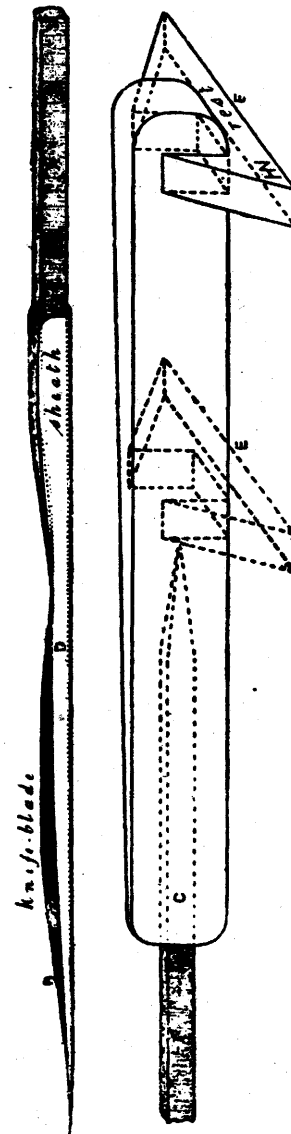

FIG. 341.—Fustian knife for cutting by hand.

of six, to cause them to float over five, warp threads. In this example, every third warp thread only is utilised for binding pile picks to the ground texture, namely, the first and fourth in each repeat of the pattern; whilst all warp threads interweave with ground picks to produce the foundation texture. This combination of threads causes the floats of pile picks to develop a series of courses or passages running lengthwise, termed "races," which lie above the ground cloth and along each of which a fustian cutter passes the fustian knife, so that the cutting edge of the latter passes under all floats of weft forming a "race," thereby severing them in the centre and causing them to become erect on each side of a binding thread to produce the characteristic short tufts of pile. This is clearly illustrated in Fig. 340 B, which represents a transverse section of cloth (produced from the design above it) both before and after cutting. The paths along which the fustian knife takes its course, and also the points at which pile picks are severed, occur at intervals of three warp threads, as indicated by arrows.

§ 65. A fustian knife for cutting by hand is illustrated in Fig. 341. It consists of a square

steel rod A, beaten out at one end to form an extremely thin keen-edged blade B, and is provided with a handle C at the other end. The knife blade is inserted in a shaped and pointed sheath D, of sheet iron or steel, which serves the threefold purpose of (a) giving firmness to the slender blade; (b) guiding the blade along its true course under the proper floats; and (c) tautening the floats of weft as it passes under and brings them up to the exposed edge of the knife to be severed. Fustian knives are made in various lengths, from about 12 ins. to 30 ins., from steel rods varying from $\frac{1}{8}$ in. to $\frac{1}{4}$ in. square, and each is provided with a sheath or guide specially shaped and pointed to suit the particular kind of cloth for which it is intended (as velveteen or corduroy), and also the width of "race" A fustian knife handle is sometimes furnished with a piece of wood E, to serve as a rest for the knife, and maintain it at the proper angle as it traverses a "race" The rest E is fixed at the rear end of the haft when cutting velveteen on a "short-run" frame (of 2 yards in length), and in the centre of the haft (as indicated by dotted lines) when cutting corduroy.

§ 66. Before being submitted to the operation of fustian cutting, velveteens are first subjected to a process of liming, in which a thin coating of lime paste is applied to the face side of cloth by passing it over a roller revolving in slaked lime. From the lime trough the cloth is immediately passed over a number of steam-heated cylinders to be dried; after which it is coated on the back with flour paste and again dried for the purpose of stiffening it and to prevent the withdrawal of tufts of pile during cutting. After this preparation, the cloth is made taut by stretching in a suitable frame of either 2 or about 10 yards in length, when the cutter passes a knife smartly along successive "races," taking each in turn from one selvedge to the other. Subsequent lengths of cloth are then stretched and cut in a similar manner until the whole piece is completed, after which it is submitted to various finishing processes. The operation of cutting velveteen by hand on short frames is illustrated in Fig. 342,* in which fustian cutters are shown standing at the side of

* The author is indebted to Messrs. Henry Bannerman & Sons, Limited, for their kind permission to use this illustration.

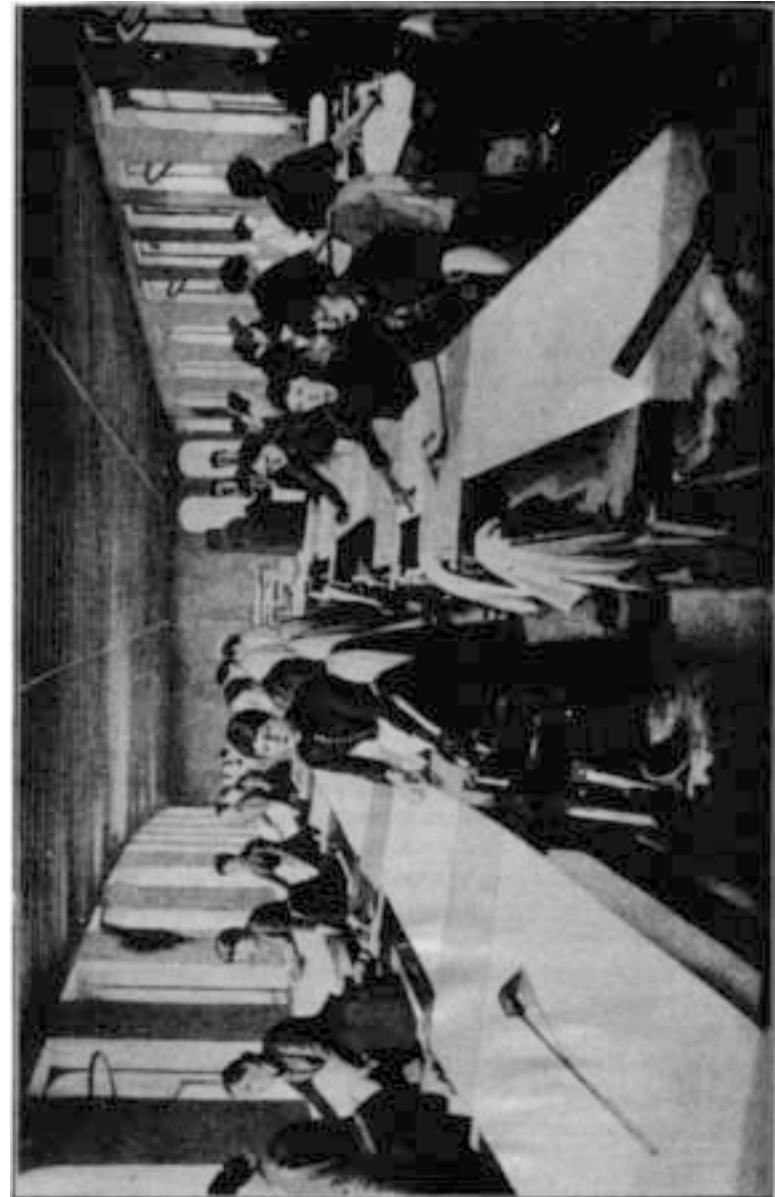

their frames; but when cutting corduroy on a short frame the cutter stands at one end.

The foregoing description of a simple example of velveteen, and of fustian cutting, will enable a student to intelligently comprehend some of the circumstances affecting the production of velveteens and corduroys, and thereby to better conform to the conditions which their construction imposes upon a designer, namely, the proper security of pile to the foundation texture, and the distribution of binding places in such manner as to provide suitable "races" or passages at regular intervals for the reception of the fustian knife.

§ 67. Fig. 343 is a design in extensive use for a tabby-back velveteen repeating on six warp threads and eight picks, having three pile picks to one ground pick, with consecutive pile picks bound by alternate warp threads at intervals of six threads. It will be observed that pile picks are bound by the same alternate warp threads that are raised for the first ground pick in each repeat of the pattern; whilst the intermediate threads are only raised for the second ground pick, thereby causing the three pile picks between each ground pick to become equivalent to, and subsequently occupy the space of, only one pick of weft. Hence, the eight picks constituting one repeat of the design are equivalent to only four picks when in cloth.

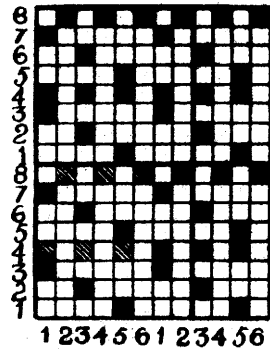

FIG. 343.—Design for velveteen fabric.

The employment of *alternate* instead of consecutive warp threads for the purpose of binding pile picks is a practice which, for several reasons, is adopted in the construction of velveteens. In the first place, it reduces the number of "races" by one-half, by creating them along alternate warp threads only, instead of along all warp threads, thereby requiring less time for cutting and reducing the cost of that operation. In the second place it facilitates the operation of cutting by developing more clearly

L

defined "races" for the reception of a fustian knife. And, finally, by causing tufts of pile to lie along alternate warp threads, instead of being distributed on all warp threads, a more perfect simulation of real velvet is produced, and one that makes the difference between velvet and velveteen sometimes very difficult to detect. The use of alternate threads of the same warp to bind over face picks as well as under back picks tends (as ex-

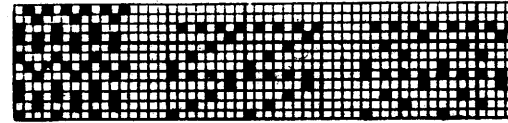

FIG. 344. FIG. 345. FIG. 346.

plained under the heads of backed fabrics and moleskins, in §§ 56 and 61) to impart a little greater strain upon those threads; but in consequence of the sparseness of warp threads, and the considerable degree of tension at which they are held during the weaving of fustians, the difference in tension between binding and non-binding threads is so small as to develop only the faintest stripiness in the uncut cloth, which entirely disappears after cutting; nor is the difference in tension such as to necessitate the binding and non-binding warp threads being wound

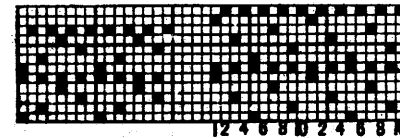

FIG. 347. FIG. 348.

upon separate warp beams. This is explained by the circumstance of warp threads being held so taut during weaving that the softer, finer and more supple weft exerts little or no influence upon them, and so they remain perfectly straight.

§ 68. Figs. 344 to 373 are examples of designs showing various modifications in the construction of velveteen fabrics. A cursory examination will show that the essential points of difference in them are in respect of their foundation weaves, and the method of securing pile picks thereto. Other points of

difference, not of a structural character, are the ratio of pile picks to ground picks, and the length of float between the binding points of pile picks. Fig. 344 is a design for a tabby-back velveteen containing two pile picks to one ground pick, with pile weft floating over only three warp threads between each inter-

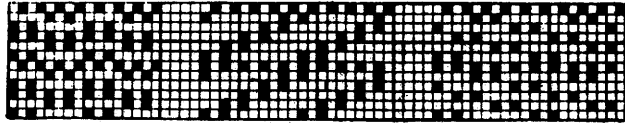

FIG. 349.

FIG. 350.—Represented by transverse section, Fig. 353.

FIG. 351.—Represented by transverse section, Fig. 354.

section, which would produce an exceedingly short and poor pile. Figs. 345, 346 and 347 are three designs for tabby back velveteens, each containing four pile picks to one ground pick, with pile weft floating over seven warp threads. Although pile picks are bound in a different order in each design, they would produce absolutely identical results in the finished fabric; as the four pile picks between two ground picks in each design

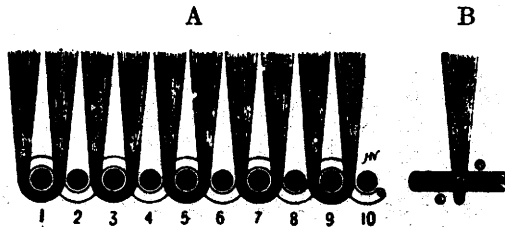

FIG. 352.—(A) Transverse section showing usual method of securing tufts of pile in the foundation texture of ordinary velveteen fabrics.

would constitute only one row of tufts disposed on alternate warp threads. Fig. 348 is a design for a tabby-back velveteen containing five pile picks to one ground pick, with pile picks floating over nine warp threads to produce a longer pile.

§ 69. Figs. 349, 350 and 351 are three examples of designs for tabby-back velveteens with a "fast" or "lashed" pile, so called because the tufts of pile are more securely attached to the

foundation texture; thus, instead of being looped under and held by only one warp thread, as in previous examples and as illustrated in Fig. 352, each tuft of pile is secured by interlacing with three consecutive warp threads, as shown in Figs. 353 and 354. Although the binding of pile picks in Figs. 350 and 351 is

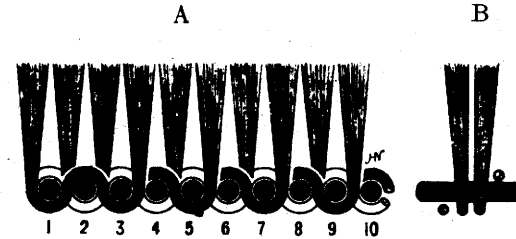

FIG. 353.—(A) Transverse section of velveteen fabric, with fast or lashed pile, from design Fig. 350.

of a different arrangement in each, they will produce no material difference in their ultimate results, as seen by comparison of Figs. 353 A and 354 A, which represent transverse sections of cloth produced from designs Figs. 350 and 351 respectively. In both examples, warp threads are raised over two out of the five pile picks between two ground picks, so that the five pile picks

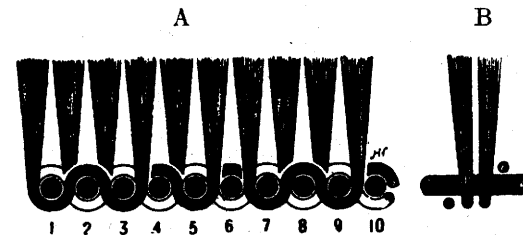

FIG. 354.—(A) Transverse section of velveteen fabric, woven with fast or lashed pile, from design Fig. 351.

will occupy the space of *two* picks in cloth (as seen in end views of sections at B). Hence, five tufts of pile will be formed over an interval of ten warp threads, from what virtually constitutes *two* picks of weft (whereas, by the method of binding shown in Fig. 352, five tufts of pile would be formed in the same interval, and from the same number of picks, which would virtually con-

stitute only *one* pick of weft (as seen in end view of section at B), and which would result, for example, from the design Fig. 348. It is evident, therefore, that a "fast" pile can only be obtained in fabrics of similar quality by sacrificing the density of tufts of pile.

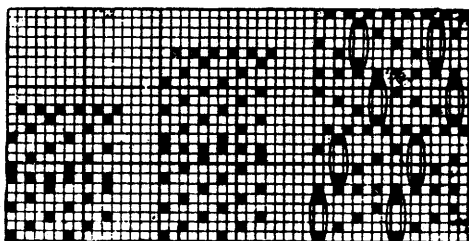

FIG. 355. FIG. 356. FIG. 357.

§ 70. It may be observed at this juncture that the relative density of pile in fabrics of similar quality may only be increased by additional rows of tufts between ground picks. Thus, instead of warp threads binding over only one pile pick between two ground picks to produce only one row of tufts (as in all

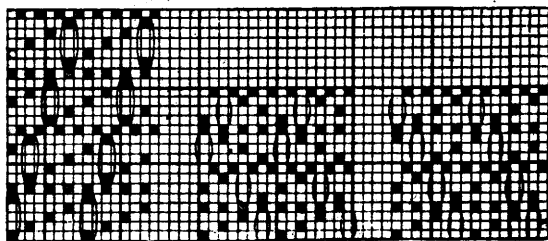

FIG. 358. FIG. 359. FIG. 360.

previous examples), they may bind over two or three pile picks to produce a corresponding number of rows of tufts between two ground picks, as exemplified in Figs. 355 and 356. Also, each binding warp thread should preferably contain the same number of tufts between ground picks to ensure a more perfect distribution of pile; though this precept is not always observed in practice, as will be seen presently. Density of pile is sometimes

slightly increased by causing additional tufts of pile to occur in certain places only, between two ground picks. Conversely, density of pile may be slightly diminished by *omitting* tufts of pile in a similar order. In either case, care should be taken to dispose the additional tufts (or the spaces where they are omitted) so that they will not tend to develop lines in any direction in the finished fabric. Any such tendency is avoided in an ingenious manner in Figs. 357 and 359, which are designed to increase and diminish the density of pile respectively. In Fig. 357 the successive binding points on pile picks are produced in an opposite direction at intervals of two ground picks, thereby disposing the additional tufts of pile in the four-end satin order

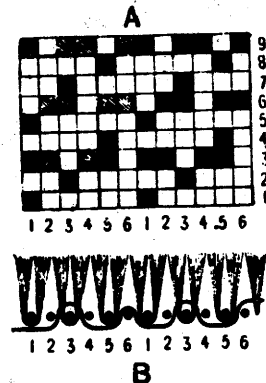

FIG. 361.

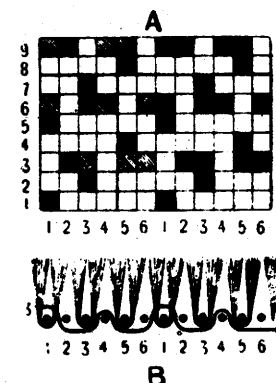

FIG. 362.

(as indicated by bracketed squares). Had the successive binding points been produced in the same direction throughout, as in Fig. 358, the regular occurrence of the extra tufts would tend to develop a series of lines running obliquely across the fabric. In Fig. 359, which will give a less dense pile, the same practice has been observed of reversing the direction in which binding points are produced at intervals of two ground picks, so as to dispose the gaps (caused by missing tufts, as indicated by bracketed squares) in a four-end satin order, for reasons just explained. Had the binding points in that design been produced in the same direction throughout (as indicated in Fig. 360), the vacant places would, in consequence of their regular succession, tend to develop oblique lines across the fabric.

§ 71. Figs. 361 to 367 are designs for velveteens of a little heavier texture than the tabby-backed variety. Their foundation texture is based on the three-end twill weave, which permits of a greater number of picks per inch being inserted to produce a more compact fabric. In other respects their construction is similar to the previous examples. Apart from the object of increasing weight, a greater degree of compactness in twill-backed velveteens is essential to hold the pile firmly; otherwise the freer character of the weave would produce a more open texture, and thereby permit of the easier withdrawal of tufts of pile. It is sometimes advocated that, when constructing twill-backed velveteens, warp bindings on pile picks that immediately either precede or succeed a ground pick should be placed counter to a weft binding on that pick, so that such warp and weft binding points will lock or check each other, and thus give

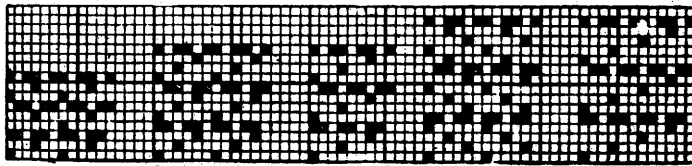

FIG. 363. FIG. 364. FIG. 365. FIG. 366. FIG. 367.

additional firmness to the fabric. A little reflection, however, will show that whilst such precaution would conduce to better results if the weft were not to be subsequently cut to form pile, it is unnecessary to observe it in the construction of a velveteen fabric in which the several picks between two ground picks virtually occupy the space of only one pick, or sometimes two picks, in the finished cloth. It may also be pointed out that, whether the warp and weft bindings are or are not placed counter to each other in the design, they automatically become so in the finished fabric; so that precisely similar results obtain whichever practice is adopted. This is clearly demonstrated by means of diagrams Figs. 361 B and 362 B, representing transverse sections of cloth (after cutting) woven from designs Fig. 361 A and 362 A respectively, which designs are identical, excepting that warp bindings on every second pile pick in Fig. 361 A

are placed counter to weft bindings of the contiguous ground pick; whereas the binding points are not so placed in Fig. 362 A, yet their transverse sections are virtually alike. (It will be observed that these two designs are identical with the mole-skin designs, Figs. 335 and 336 respectively.) Figs. 363 to

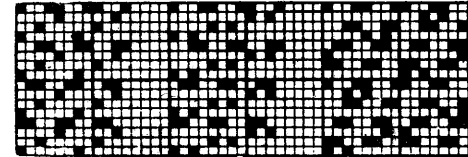

FIG. 368. FIG. 369. FIG. 370.

367 are other examples of designs for velveteens with three-end twill backs, showing various modifications; whilst Figs. 368 to 373 are for velveteens having a foundation texture based on the two-and-two twill, and other weaves, to produce still heavier textures.

Weft plushes are simply velveteens in which pile weft is

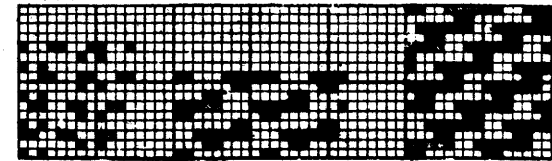

FIG. 371. FIG. 372. FIG. 373.

allowed to float over a considerable number of warp threads to produce a longer pile, the tufts of which are more firmly interlaced by interweaving them under and over three or five consecutive warp threads, as described in § 69. In all other respects their construction is similar to that of ordinary velveteen fabrics having short pile.

Ribbed or Corded Velveteen.

§ 72. Velveteen is sometimes made to assume a ribbed or corded formation, resembling that of corduroys, with the ribs or

ords produced lengthwise or parallel with warp. There are, however, so-called "velvet cords" that are not true velveteens, but simply lighter textures of corduroy, which are described under that head in §§ 75 and 76. So-called "ribbed velvet" or ribbed velveteen (also known as "hollow-cut" velveteen), however, is woven as ordinary plain velveteen, and afterwards made to assume a corded appearance by a special mode of fustian cutting, in which a cutter first passes a knife along certain "races" in each cord, with the blade vertical, as in ordinary cutting, and then along intermediate "races," with the knife blade held at different angles, to sever floats of weft out of the centre, and so form longer and shorter tufts which develop rounded ribs of pile. For some "races" the knife is inclined *towards* the cutter, and for others *away from* the cutter; hence the terms "*toward*" and "*forward*" used amongst that class of fustian cutters, whose work is regarded as specially skilful. An example of ribbed velveteen under present notice is produced from the

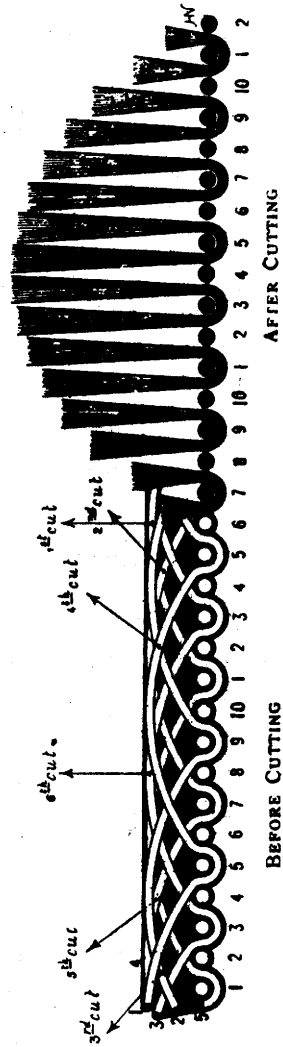

Fig. 374.—Graphic diagram illustrating a special method of fustian cutting, to develop ribs or cords upon velveteen fabrics of ordinary construction, in the manufacture of ribbed or "hollow-cut" velveteen fabrics.

design shown in Fig. 348, containing five pile picks to one ground pick, and with pile weft floating over nine warp threads. A transverse section of this cloth (before and after cutting) is represented in Fig. 374, in which arrows indicate the various angles at which the knife blade is held as it is passed along the different "races." The width of cords is not regulated by the number of warp threads on which the woven design repeats, but is arbitrarily decided by the fustian cutter, who may produce various widths of cords from exactly similar fabrics. In the present example the ribs occur at intervals of sixteen warp threads, although the woven design repeats on only ten warp threads. The same fabric could have been cut to produce broader or narrower ribs, as desired.

Figured Velveteen.

§ 73. The embellishment of velveteens is not confined to that created by a simple ribbed or corded formation. They are frequently rendered of a more or less ornate character by means of designs printed in various colours, embossed designs, and designs produced by Jacquard machines. Many woven designs are of a somewhat elaborate character, as exemplified in the specimen reproduced in Fig. 375.

The construction of Jacquard-figured velveteen is governed by the same principles as those regulating the construction of simple velveteen, so far as the development of pile in the figure portion is concerned; but in the ground portion of the pattern, which is without pile, some method must be adopted to effectually obscure pile weft from the face of the fabric. Various methods are employed to achieve that object. By one—which is perhaps the most generally satisfactory method—when pile picks are not required on the face for the development of figure, they are placed at the back in the ground portion, and interwoven with binding warp threads in an exactly opposite manner to that which obtains in the figure portion. By another method (of which the specimen illustrated is an example), surplus pile weft is allowed float quite freely beneath the ground portion, and after the operation of cutting, it is brushed off as waste

material. A third practice is to employ an extra fine warp to interweave loosely with surplus pile weft at the back of cloth for the purpose of producing a light gauzy and imperfect tissue, which, after the operation of cutting, is drawn bodily away from the principal texture, thereby removing all surplus pile weft. This precaution, however, is only necessary for designs containing comparatively large areas of ground filling, in which case



FIG. 375.—Velveteen figuring by Jacquard machine.

the resulting masses of floating weft at the back would be liable to be caught and pulled both during and subsequent to weaving, thereby involving risk of injury to the fabric and impeding the operation of cutting.

§ 74. When preparing an applied or working design for a figured velveteen fabric, it must be first drawn to the required dimensions on the proper counts of squared or point paper, and painted in *en bloc*, as in Fig. 376. It may then be transposed

to point paper of any other counts to be "read off" by the card cutter. The proper counts of design paper for the block design is determined according to the number of rows of tufts to be contained in one inch, both horizontally and vertically, because the margin of figure steps in intervals of tufts of pile each way; thus each small square of the block design corresponds to one tuft. If, therefore, a design is to be prepared for a fabric containing 88 warp threads and 420 picks per inch, with pile weft bound by alternate warp threads, and having three pile picks (which constitute only one horizontal row of tufts) to one ground pick (as in the present example), the proper counts of point

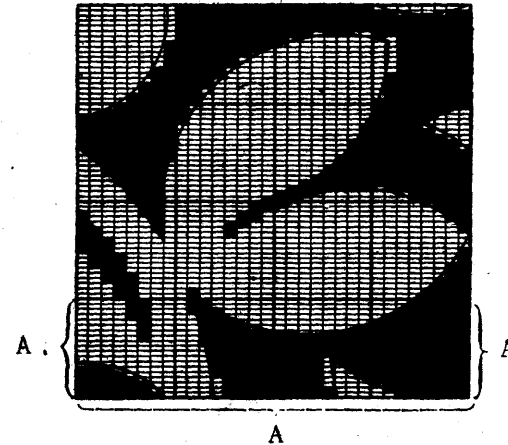

FIG. 376.—Block sketch-design for figured velveteen fabric.

paper for the block design is in the ratio of $(88 \div 2 = 44)$ to $(420 \div 4 = 105)$; or (assuming a Jacquard machine has eight long rows of hooks) the point paper should contain eight squares by nineteen squares in each bar. If a fabric contains four pile picks, constituting only one row of tufts, between two ground picks, the number of horizontal rows of tufts per inch will be one-fifth of the actual number of picks inserted. Again, if a fabric contains six pile picks constituting *two* rows of tufts between two ground picks, the number of horizontal rows of tufts per inch will be two-sevenths of the actual number of picks inserted, and so on.

It is necessary to prepare the pattern *en bloc* on design paper of the proper counts in order to ensure that the correct forms and shapes of its component parts will be preserved when reproduced in cloth; but the counts of paper employed for the working design, and from which pattern cards are read off by the card-cutter, is quite immaterial. When preparing an applied design from a block pattern, it must be remembered that all warp threads are controlled by a Jacquard machine, and that a pattern card is required for each pick of weft inserted. Therefore, since each small square of the block pattern corresponds to one tuft of pile, each vertical space on the former represents two, three, or four spaces on the working design (according as tufts of pile are contained on alternate warp threads, or on every third or fourth warp thread), and each horizontal space in the block pattern represents the number of pile picks inserted for each ground pick, plus one ground pick. For these reasons, when setting out the pattern for the working design, the margin where figure and ground meet must change or step at intervals of two or more warp threads in a horizontal direction, and at intervals of two, three or more picks in a vertical direction, according to the weave selected.

Fig. 376 is a portion of the pattern, *en bloc*, of the cloth represented in Fig. 375. A small portion of the block pattern (bracketed) is shown transposed in Fig. 377, and is developed for a tabby-back velveteen containing four pile picks to one ground pick, with pile weft bound by alternate warp threads, and in accordance with the first-named method as described in § 73. By this method pile picks are placed at the back in the ground

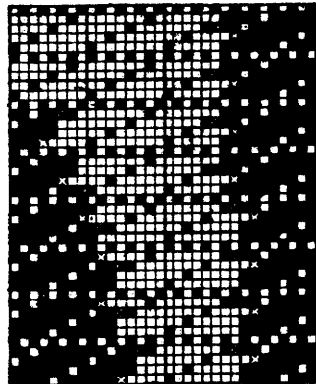

FIG. 377.—Portion of applied design (for figured velveteen fabric), demonstrating the development of the block sketch-design (part A) Fig. 376.

portion and interwoven with binding warp threads in an opposite manner to that of the figure portion. The margin of figure in a vertical direction in velveteens constructed in accordance with this method is always formed with a half-tuft, *i.e.*, one-half of a complete loop (thus J). For this reason it is advisable to continue some short marginal floats of weft to their full extent, and to stop others that are very short (as indicated by white and black crosses respectively), and thus prevent short marginal tufts of pile. This object will be more easily achieved by forming the margin of *ground* (in a vertical direction) with the binding warp ends only, as observed in Fig. 377.

Fig. 378 is a portion of the same block pattern showing the development of a working design for figured velveteen, in accordance with the second method as described in § 73, by which surplus pile weft floats loosely beneath the ground portion of the fabric, to enable it to be readily brushed away after the operation of cutting, and is a reproduction of a portion of the fabric represented in Fig. 375, which is a tabby-back velveteen containing three pile picks to one ground pick, with alternate warp threads employed for binding pile weft. The scheme of binding pile picks in this example is the same as that given in Fig. 359, in which tufts of pile are omitted in a certain order, for the twofold purpose of increasing the length, but reducing the density, of pile. It should be observed that in velveteens constructed in accordance with this method the margin of figure in a vertical direction is formed with entire tufts, as any half-tufts that may be formed during the operation of cutting are withdrawn on removing surplus pile weft from the back. For this reason, greater care is required on the part of a designer in order to preserve a good margin of figure and ground. This may be accomplished by extending certain marginal floats into the ground portion, of sufficient length to enable the fustian knife to pass underneath and cut them, and also by filling in the spaces to stop all floats of weft that are too short to be cut, as indicated on the working design by white and black crosses respectively. By carefully studying this design, the method of preparing designs on this principle will become manifest.

As observed in § 73 velveteens are sometimes ornamented by

an operation of stamping, whereby plain velveteens are furnished with embossed designs which closely simulate those produced by Jacquard machines. The fabrics to be ornamented in this way are subjected to considerable pressure against a roller matrix of the required pattern, which depresses the pile to form the

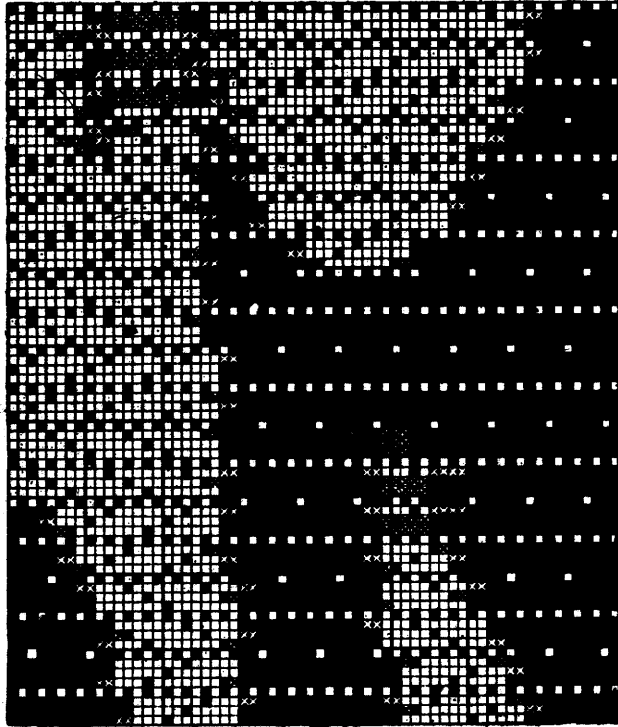

FIG. 378.—An alternative method of developing an applied design for a figured velveteen fabric.

ground portion, and leaves the pile erect in the figure portion, which stands out in sharp relief as an embossed design. When put into use, the pattern of an embossed velveteen becomes indistinct and finally obliterated, in consequence of the depressed tufts of pile in the ground portion being disturbed by friction, and thereby becoming partially erect. Thus, the difference

between woven and stamped figured velveteen may be easily detected by scratching the ground portion with a pointed instrument, which will raise the depressed pile in that part of the counterfeit fabric.

Corduroy Fabrics.

§ 75. Corduroy fabrics are constructed on similar principles to those governing the construction of velveteens, and, like those, are submitted to an operation of fustian cutting for the development of a pile surface. They are, however, produced in much heavier and more durable textures than velveteens, in view of the greater wearing properties required of them. They consist of a foundation texture, usually based upon a three-end or four-end twill or other simple weave, containing tufts of pile disposed at regular intervals on from two to six contiguous warp threads (according to the width and character of cord required) in such manner as to develop a series of rounded pile ribs or cords in the same direction as warp threads. The ribs are usually of uni-

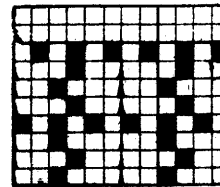

FIG. 379.—Design for corduroy fabric.

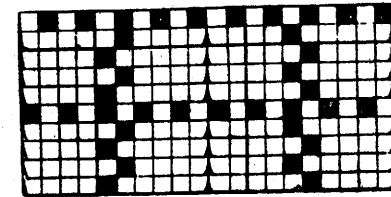

FIG. 380.—Design for corduroy fabric.

form width in the same fabric, but sometimes they are variegated. Most corduroy fabrics have pile and ground picks in the ratio of two to one respectively, with a twill foundation weave; but, as stated previously, in § 72, some varieties known as "velvet cords" are produced in comparatively light textures based on the plain or tabby weave, and containing three, four and five pile picks to each ground pick, to produce a denser pile. Fabrics of this description are usually employed in the production of boys' and ladies' clothing. Figs. 379 and 380 are two designs for "velvet cords," each having a foundation texture of plain cloth and containing three and four pile picks to each ground pick respectively. A transverse section of cloth (before and after

cutting) produced from design Fig. 380 is represented in a graphic manner in Fig. 381. As a fustian knife is thrust along each successive "race," the floats of weft are severed at or near the centre, thereby producing tufts of pile, which rise on each side of binding warp threads and form the characteristic rounded ribs of pile.

The rounded or convex formation of cords in corduroys is entirely due to floating weft being cut at unequal distances on each side of binding points, thereby causing each complete tuft to be formed with a long and short tuft (thus J). This will be easily understood on examining Figs. 379 and 380, in which are indicated the points at which floats of weft are severed by the fustian knife. In Fig. 379 the binding points of pile picks occur in the same order for each rib, thereby producing all floats of the same uniform length, and causing each cord to constitute one repeat of the design: whereas in Fig. 380 the binding points of



Fig. 381.—Graphic diagram of the transverse section of corduroy fabric, from design Fig. 380, showing certain picks of weft both entire, and also after being severed by the fustian knife to form tufts of pile.

any two contiguous ribs are in reverse order, thereby producing floats of *two unequal lengths* and causing *two cords* to constitute one repeat of the design. In the first example all floats will be cut a little *out* of the centre, and in the second example they

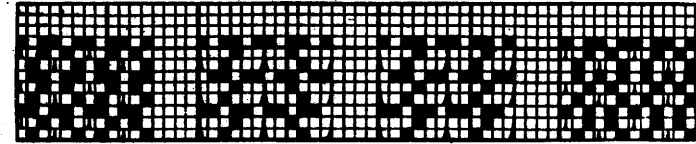

FIG. 382. FIG. 383. FIG. 384. FIG. 385.

will all be cut *exactly in the centre*; yet, in both instances, each complete tuft will be formed with a long and short tuft with precisely similar results, notwithstanding the two different methods of binding pile weft.

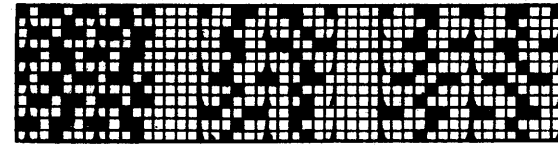

FIG. 386. FIG. 387. FIG. 388.

§ 76. Fig. 382 is the simplest and smallest design for a corduroy fabric, commonly termed "thickset" cord. It repeats on six warp threads and nine picks, and has a foundation texture based on the three-end twill weave, with two pile picks to one

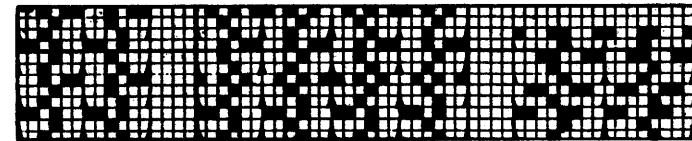

FIG. 389. FIG. 390. FIG. 391.

ground pick. The floats of weft are very short—being over only three warp threads—thereby producing a short stubby pile, the tufts of which are firmly bound in the ground cloth, after the manner of "lashed" pile, described under the head of velveteens in § 69. Figs. 383 to 397 are other designs for corduroys showing

various modifications in their construction as regards their foundation weaves, widths of cords, ratios of pile and ground

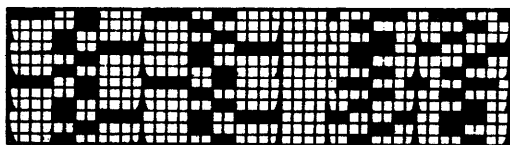

FIG. 392.

FIG. 393.

picks, methods of binding pile weft, and many other interesting features that will become manifest to observant students and

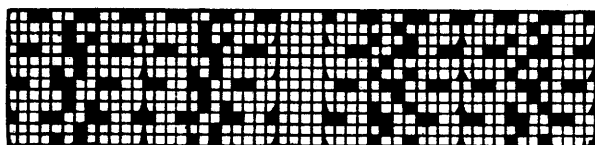

FIG. 394.

FIG. 395.

which it will well repay them to investigate. The irregular method of binding, exemplified in Figs. 394 to 397, is for the

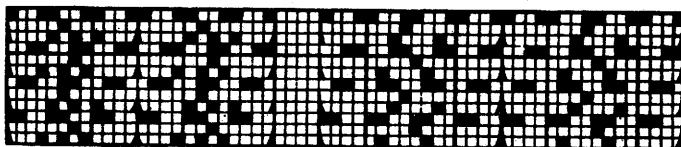

FIG. 396.

FIG. 397.

purpose of producing a variety of different lengths of floats, which, after cutting, will produce various lengths of pile, and thereby develop cords having a much rounder formation.

Figured Corduroy Fabrics.

§ 77. Fabrics of the variety of corduroys known as "velvet cords" are sometimes figured on a similar principle to that which obtains in some figured velveteens, namely, by causing pile weft to float on the face in the usual manner where it is required to form figure, and to interweave it at the back, in the ground portion, in an opposite manner. An example of figured

"velvet cord" constructed on this principle is reproduced in Fig. 398, with the method of preparing a design for the same, shown (in part) in Fig. 399. This example has a foundation texture of plain cloth, with four pile picks to one ground pick, and with each rib extending over six warp threads. In conse-

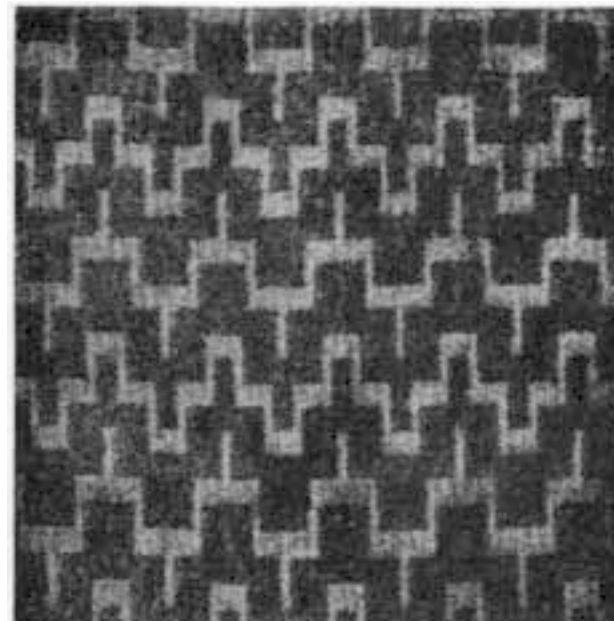

FIG. 398.—Figured corduroy, from design Fig. 399.

quence of the ornamentation of these fabrics being developed by a series of straight ribs occurring at regular intervals, it should be of a very simple character, consisting entirely of straight lines, as it would be impossible to satisfactorily develop curved lines upon them.

Corduroy Cutting.

§ 78. The cutting of corduroy fabrics is performed, as previously stated, sometimes by hand, similarly to that employed for velveteens (as described in §§ 65 and 66); but perhaps more

extensively by machinery, as their coarser and stronger texture renders them better adapted than velveteens to mechanical cutting. Fustian-cutting machines comprise various modifications of two distinct types, known as "circular-knife" and "straight-knife" machines. A graphic full-scale diagram illustrating the

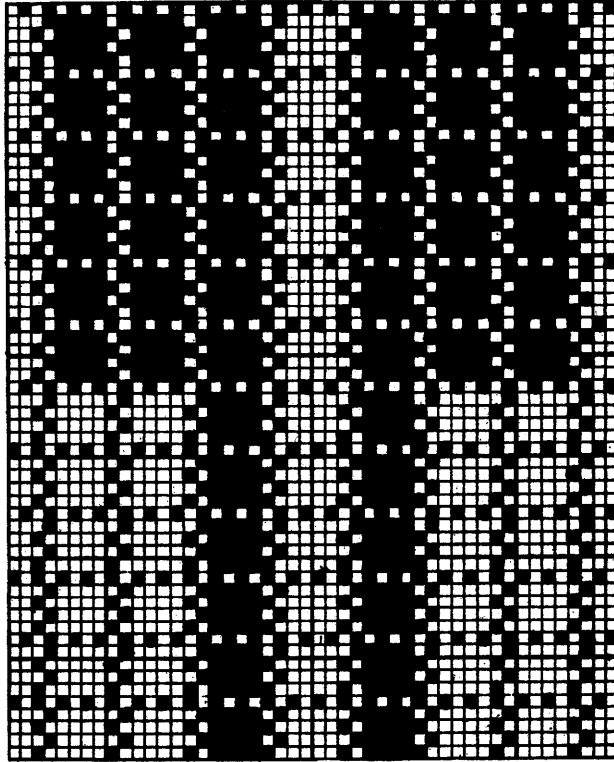

FIG. 399.—Design for figured corduroy fabric, Fig. 398.

operation of a "circular-knife" machine is shown in Fig. 400. In this machine all cords across the entire width of cloth are cut simultaneously by means of a corresponding number of thin sharp-edged steel discs B, placed at regular intervals (coinciding with the width of cords) upon a mandrel A, which extends across the machine and revolves with considerable velocity in

the direction indicated by an arrow D. As the knives revolve, cloth advances towards them in the direction indicated by an arrow F, to a point H, where it is sharply deflected over the bevelled edge of a cross-rail G. At this point, floats of weft forming each "race" are directed and presented by means of

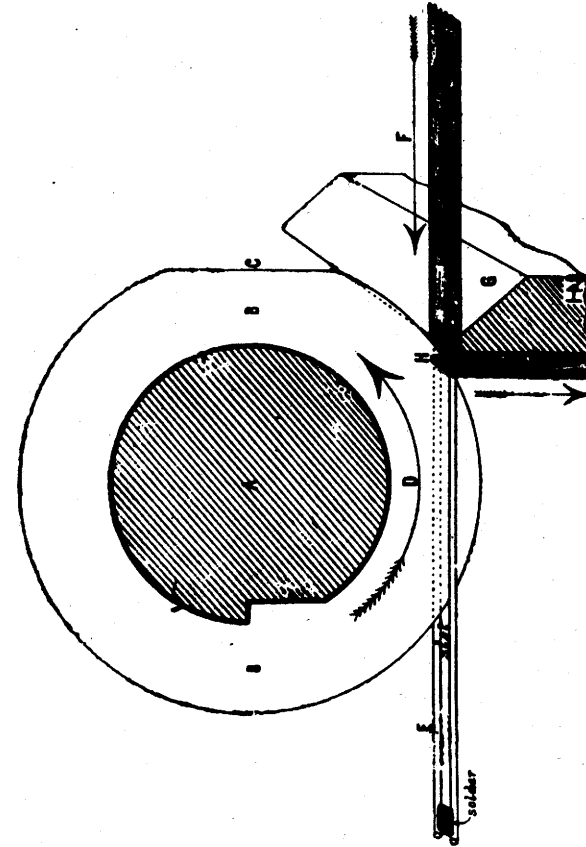

FIG. 400.—Part section of a "circular-knife" fustian cutting machine.

guide wires E to their respective knives to be cut. A guide wire E is inserted in each "race," with the lower portion of a knife partially entering its long narrow slot. Guide wires E are pieces of steel wire bent acutely to form a long loop. The extremities of the wire are soldered together where they meet, whilst the

curved end is flattened and slightly bent as shown. They are inserted in the "races" of cloth with the point downward and pointing in the opposite direction to that in which cloth approaches the knives. Guide wires serve the functions of (a) guiding floats of weft forming a "race" to the knives, and tautening them as they are cut; and (b) keeping the knives (which are not fixed rigidly, but are placed somewhat freely upon the mandrel) in the centre of each "race." A small segment is cut off each knife, as shown at C, to reduce their diameter at that part. Thus, by turning the mandrel until the straight edges C of the knives are at the cutting point H, it allows a little greater space between the knives and the rail edge, thereby facilitating the insertion of guide wires in the "races" at the commencement of cutting, or subsequently for the replacement of wires that may become injured.

As the uncut cloth approaches the knives, guide wires are conveyed along by it, and consequently require to be pushed forward again intermittently. This is accomplished by means of pushers actuated at frequent and regular intervals by a series of spirally arranged rotary cams. Each pusher acts upon three or more guide wires (according to the width of cords) at their soldered ends, so as to push them forward in groups instead of collectively, thereby ensuring greater constancy of action by preventing extreme fluctuations of energy exerted by the machine, and also of motive power required to drive it.

§ 79. Fustian-cutting machines of the second-named type are constructed either with four stationary knives or one stationary knife, to cut four cords simultaneously, or only one cord at a time respectively. In either case, the extremities of cloth to be cut are sewn together to form an endless band or web, which is passed through the machine at a rapid pace as often as is required to complete cutting. After each complete circuit of the entire length of the cloth, the machine is stopped, and the knife or knives adjusted by hand to cut the next "race" or "races". In a four-knife machine, the knives (which are similar to those employed in hand cutting) are fixed at intervals corresponding to one-quarter of the width of fabric to be cut, and operate in a similar manner to a hand fustian knife, excepting that the cloth

advances upon the knives in the former, whilst in hand cutting a knife is thrust along cloth which is held stationary. The adjustment of the knives in these machines is so contrived that, on their leaving a "race," penetrating cloth, meeting with any obstruction, or from any other irregularity which constitutes an impediment, the machine stops automatically.

CHAPTER VIII.

TERRY AND LOOP PILE FABRICS.

§ 80. "Terry pile" is a term used to distinguish a variety of woven fabrics that are characterised by the formation of a series of loops (thus \cap) projecting from the main body of the fabric. These loops are formed by an extra series of comparatively slack warp threads, and may be distributed uniformly either on the face side only, or on both the face and back of the fabric, to form a perfectly even surface; or the loops of pile may be developed in such manner as to create a figured design upon a plain or simple ground. Or, again, a figured terry fabric may contain an all-over pile surface on both the face and back, with the figure and ground portions developed in contrasting colours of pile warp threads.

A terry or loop pile surface may be developed, during the operation of weaving, by each of three distinct methods, namely: (1) By means of wires that are inserted in the warp sheds at intervals (as if they were picks of weft) and subsequently withdrawn, thereby causing all warp threads that passed over them to form a corresponding number of loops; (2) By means of what are known as "terry pile motions," whereby, during weaving, several picks of weft are inserted a short distance from the "fell" of the cloth (or last pick inserted), to produce a short gap or "fret," after which they are all pushed forward together to take their final place in the fabric. (As each group of picks are thus pushed forward by the reed, pile warp threads buckle or loop either on one side only or on both sides of the cloth as predetermined, and so develop the characteristic loops of pile known as "terry," loop, or uncut pile); and (3) By interweaving pile warp threads in such a manner that a looped or terry pile may be produced in an ordinary "fast-reed" loom without

(169)

employing a special "terry pile motion," and in which each successive pick of weft is beaten-up to the "fell" of the cloth, as in the production of a fabric of ordinary construction, and in the manner described subsequently in §§ 97, 98 and 100.

Examples of looped pile fabrics produced by the aid of wires are seen in Brussels and warp-printed tapestry pile carpets, moquette pile, mohair and other furniture upholsterings of comparatively heavy texture, as well as in silk upholsterings of much lighter texture and great beauty. In fabrics of this description the pile is formed on one side only, and (with the exception of tapestry pile carpets) pile warp threads may sometimes lie perfectly straight or interweave as ordinary warp threads, and then be required to form loops of pile, all within a short interval. Under these circumstances, pile warp threads are severally contained upon a corresponding number of bobbins that are separately weighted to permit of the independent withdrawal of their threads, and thus provide for their variable and irregular contraction. If all pile warp threads were contained on the same warp beam, they would, of necessity, either be required to form pile or else lie straight, uniformly, at the same time, in consequence of their uniform and simultaneous delivery during weaving.

§ 81. Terry fabrics produced by means of terry motions are exemplified in so-called "Turkish" towels, bath mats, counterpanes, antimacassars, toilet covers and mats, and many other articles employed for domestic purposes, and in which the loops of pile occur with a more or less dense or close formation. The majority of these goods are produced entirely from cotton, although terry towels are sometimes produced either entirely or in part from linen. Terry weaving is a principle eminently adapted to the production of towels, as the loops of pile give considerable bulk and impart good absorptive properties to the fabric. The variety of terry fabrics under present notice are produced from two distinct series of warp threads, namely: (a) ground warp threads, and (b) pile warp threads, each of which is contained on a separate warp beam. They are usually employed in equal proportions, and arranged in the harness and reed either alternately with each other, or else in alternate pairs of ground and pile threads.

The particular disposition of warp threads, however, is quite optional. Some advocate an alternate distribution of ground and pile warp threads, whilst others prefer to dispose them in alternate pairs of each series of warp threads. In both cases the ultimate results are virtually alike. During weaving ground warp threads are held taut, whereas the warp beam containing pile warp threads, is very lightly weighted to enable those threads to be easily withdrawn for the formation of loops of pile. Terry fabrics are termed three, four, five or six-pick terry fabrics, according to the number of picks inserted for successive horizontal rows of loops. Most of these fabrics are constructed with only three picks for each row of loops. The object of inserting a greater number of picks for each row of loops is to produce a superior fabric and to bind pile warp threads more securely to the foundation texture.

Terry Pile Motions.

§ 82. Before describing the construction of terry fabrics, however, it will be helpful briefly to describe the essential features of terry-forming devices, as this course will the more readily conduce to a clearer conception of the essential conditions governing the construction of this type of fabrics. Terry pile motions are usually based upon one or other of three distinct mechanical principles; but the greater number are constructed on what is known as the "loose-reed" principle, as represented in Fig. 401. If these devices are based upon this principle, they are designed to act upon the reed in such manner that, as the sley advances, the reed is caused to swing or fall backward, at the bottom, from its normal vertical position to an inclined position, for *two only* out of three or more picks, after which the reed is securely fastened in its normal position for the following pick (or picks), when all are thrust forward together to take their final place in the cloth. As the picks are thus thrust forward from their temporary to their final position, they slide along the tense ground warp threads; but the degree of frictional resistance between the three picks and slack pile warp threads is sufficient to draw the latter forward *en masse*, thereby causing them to bend and thus form a series of loops to constitute the pile surface.

As the reed swings backward at the bottom, for the two "loose" picks, it swivels on the upper ribs which are retained in a mortise cut into the under side of the sley cap. Therefore, since the line of contact made by the "fell" of cloth with the reed is situated approximately midway between the upper and lower ribs of the latter, it follows that the bottom of the reed will require to recede (for the two "loose" picks) for a distance of not less than twice the length of gap or "fret" necessary to yield the desired length of pile on the fabric. Such excessive backward movement of the reed creates a tendency to develop loops

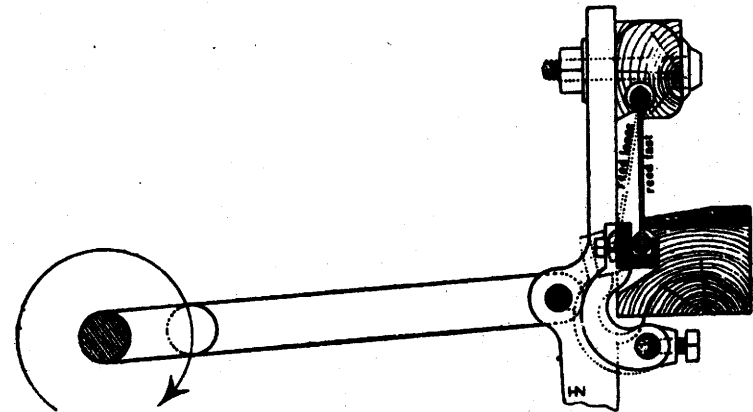

FIG. 401.—Loose reed action, for terry pile weaving.

of pile of irregular lengths in different *horizontal* rows of pile, but not in the same horizontal rows. This tendency arises in consequence of the abnormal inclination of the reed from the normal vertical position, whereby it inclines forward at the top, and therefore bears downward upon the "loose" picks as it approaches the "fell" of cloth. Hence, those picks tend more or less to slide downward along the reed (according to circumstances to be stated presently), and thus produce gaps or "frets" of different lengths, and, therefore, different lengths of pile.

This evil is more liable to manifest itself in *figured* terry fabrics in which the number of pile warp threads either raised

or depressed is liable to fluctuate according to the design. Thus, the "fell" of the cloth will occupy either a higher or else a

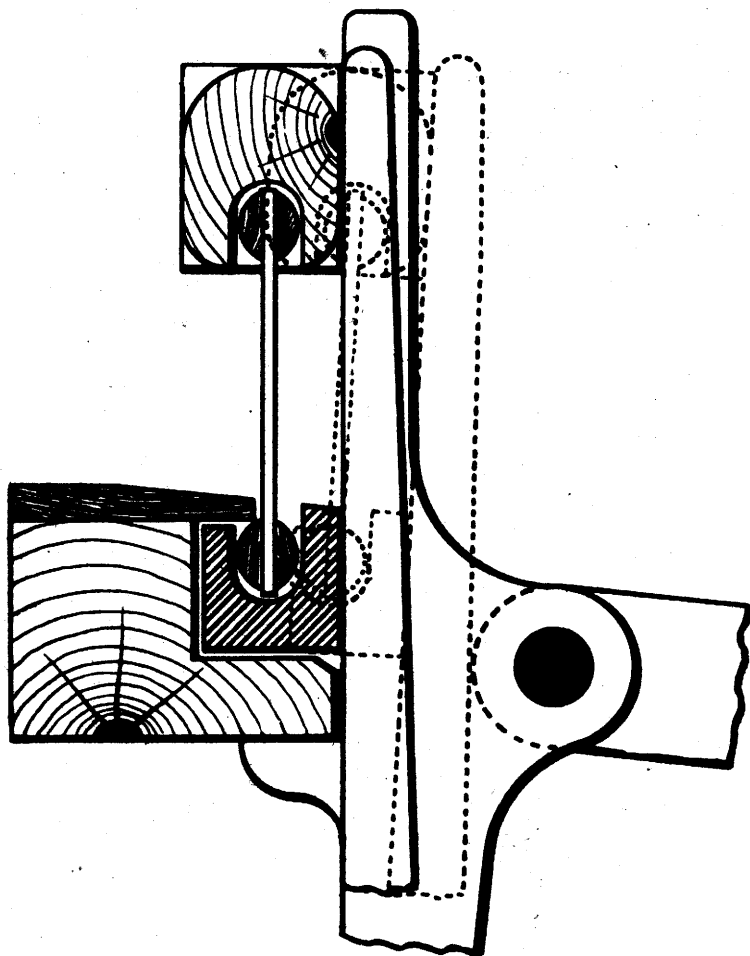

FIG. 402.—Loose reed action for terry pile weaving.

lower plane during beating up, according to the preponderance of warp threads in either the upper or lower half of the warp shed respectively; also, the strain upon the reed, as it approaches

the "fell" of the cloth, will be greater or less in proportion to the number of warp threads forming the bottom half of the warp shed, because they bear against the reed farthest from the upper ribs on which it swivels in the sley cap.

§ 83. A modification of the "loose-reed" principle of terry weaving, and one that is designed with the object of overcoming the disadvantages of the system just described, is effected by mounting the reed in a separate case or frame carried at the upper ends of two long vertical arms that extend downwards and are respectively fulcrumed either upon studs secured to the sley swords, or else upon the rocking shaft on which the sley oscillates, as illustrated by a graphic diagram in Fig. 402. The said arms are analogous to auxiliary sley swords for the sole purpose of supporting the reed only, so that the latter may be carried *bodily* backward, with the least deviation from its normal vertical position, when beating up the two "loose" picks to produce the desired length of gap or "fret" at the "fell" of the cloth. After the two "loose" picks of weft are inserted, however, the reed-case, containing the reed, advances to its normal forward position in which it becomes locked rigidly in order to thrust the two "loose" picks, along with the first "fast" pick, forward, to take their final position right up to the "fell" of the cloth, and thus withdraw the slack pile warp threads to produce the loops of terry pile in the manner described.

Instead of supporting the reed-case at the upper ends of auxiliary arms that are hinged in the manner just described, an alternative method is to slide the reed-case and reed backward, for the two "loose" picks, and then forward, in a perfectly horizontal direction, whereby the reed is maintained always in a true vertical position instead of inclining backward either from the lower or the upper edge, as indicated in Figs. 401 and 402 respectively.

Holden's Terry Motion.

§ 84. A second type of terry pile motion is designed to oscillate the sley for a shorter distance for the two consecutive "loose" picks, and for a greater distance for the third and following "fast" picks inserted for each horizontal row of loops.

By this means, two out of three or more picks are beaten up within a short distance from the "fell" of cloth, and then after the third pick is inserted in the warp shed, the three picks are hrust forward together as described, although the reed remains fixed in the loom sley, as in a "fast-reed" loom. This is effected in the manner illustrated in Fig. 403, which represents Holden's terry motion designed with the object of imparting to the loom sley and reed a variable length of stroke when beating-up the "loose" and "fast" picks respectively. By this method the connecting-pins C of the connecting-arms B are inserted quite freely in vertically slotted ears D of the sley swords E in which

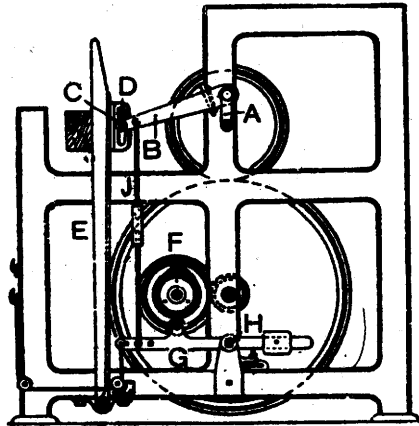

FIG. 403.—Holden's terry motion.

those pins rise and fall, and so virtually increase or decrease the length of the sley swords to impart a shorter or a longer stroke to the loom sley when beating-up the "loose" and "fast" picks respectively. The vertical sliding movement of the connecting-pins C is governed by means of tappets or cams F which act upon weighted treadle-levers G, fulcrumed on studs H, and from the forward ends of which levers' motion is transmitted through the medium of connecting link-rods J to the connecting-arms B of the loom cranks A, as indicated in the diagram. By changing the point of connection between the connecting link-rods J and the treadle-lever G, the variation in the stroke of the loom sley may, within certain limits, be regulated so as to produce loops

of terry pile of different length uniformly. Also, the movement of the loom sley may be adapted to the production of terry fabrics of any variety by employing tappets F that are designed and driven according to the number of picks to be inserted for each horizontal row of loops of pile as, for example, 3-, 4-, 5- and 6-pick terry fabrics.

Lister and Carter's Terry Motion.

§ 85. A third type of terry pile motion, and one that is designed to operate in an exactly contrary manner to either of the

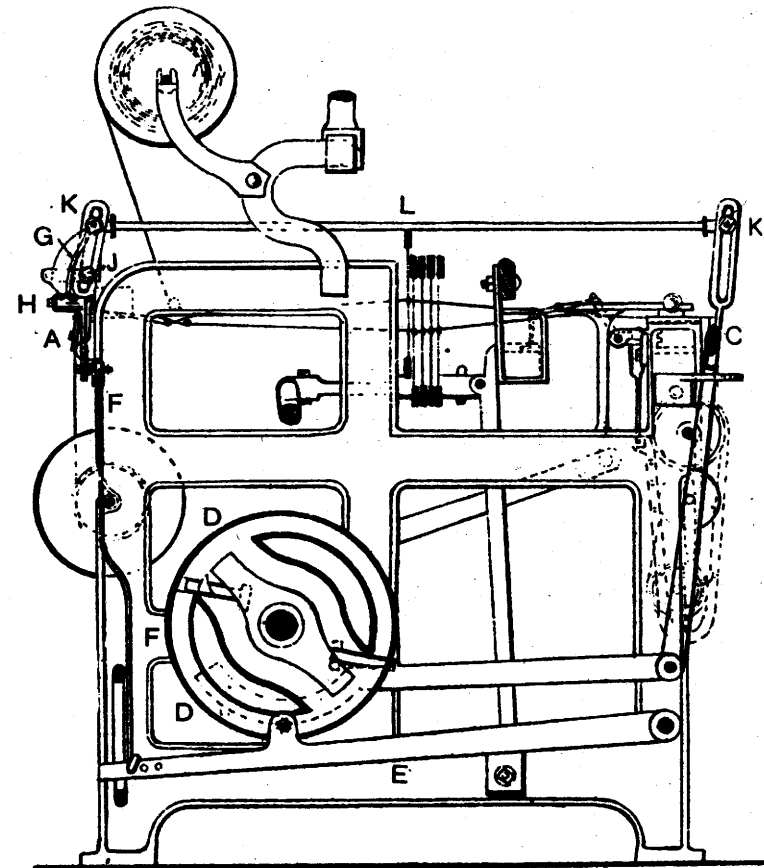

FIG. 404.—Lister and Carter's terry motion.

two types just described, is that of Lister and Carter's, as illustrated in Figs. 404, 405 and 406. Thus, instead of causing the

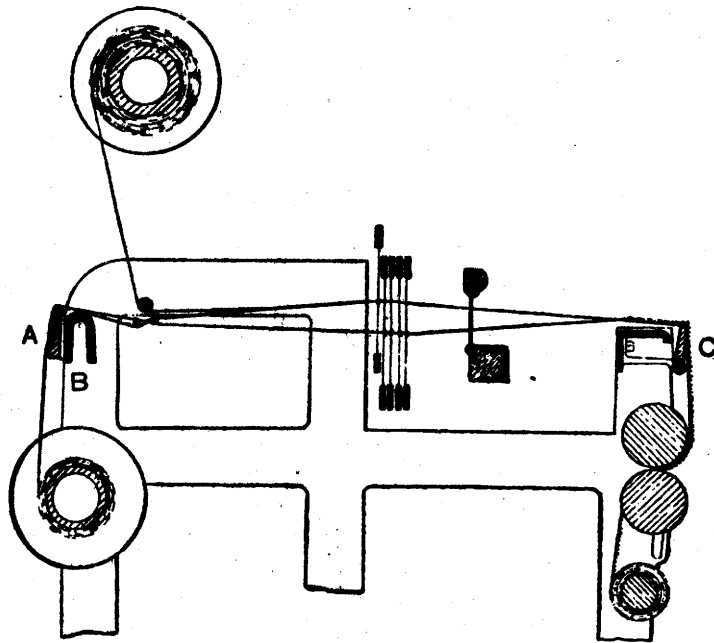

FIG. 405.

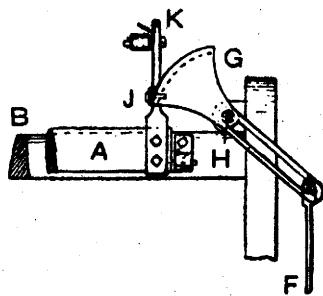

FIG. 406.

reed to swing backward for a short distance in order to produce a gap or "fret" at the "fell" of the cloth, the latter, along with

N

the entire stretch both of ground and pile warp threads, is drawn forward bodily for a short distance in advance of the reed, when beating-up the two "loose" picks of weft, whilst the reed is mounted rigidly in the loom sley, as in a "fast-reed" loom. This object is effected by passing the warp threads over a rocking-bar A immediately behind the fixed "back-rail" B situated in the rear part of the loom, with the cloth passing over a similar rocking-bar C situated immediately in front of the front or "breast-rail," in the fore part of the loom, and also by oscillating both the front and back rocking-bars to and fro simultaneously, in order to carry the entire stretch of all the warp threads and cloth forward, bodily, for two out of three or more picks of weft, after which the two rocking-bars return to their normal position, thereby causing all the picks of weft to be thrust forward by the reed to take their final place in the cloth.

The intermittent reciprocal movement of the front and back rocking-bars A and C is governed by a grooved tappet D which operates through the medium of a long side lever E and a connecting link-rod F, of which the upper end is connected to the end of a segment cam lever G fulcrumed on a stud H and formed with an inclined beaded rim edge that bears preferably against a small anti-friction bowl or runner mounted on a stud J fixed in one of two similar slotted arms K, secured one at each end of the rear rocking-bar A, as indicated by a rear view of these parts represented in Fig. 405. Two similar slotted arms K, K' are also secured one at each end of the front rocking-bar C with which the rear rocking-bar communicates by means of two long connecting link-rods L, of which there is one at each side of the loom, to ensure a perfectly parallel movement of those rocking-bars as these advance whilst the two "loose" picks of weft are inserted, and also as they return for the "fast" pick or picks of weft, in the manner described.

Dugdale's Terry Motion.

§ 86. The prevailing forms of terry pile motions, however, are based chiefly on the "loose-reed" principle, as illustrated in Fig. 401, and of which there are many modifications that are