

THE
STUDENTS' HANDBOOK
OF
PRACTICAL FABRIC STRUCTURE

MARSDEN AND CO. LTD., MERCURY WORKS, MANCHESTER.

THE
STUDENTS' HANDBOOK
OF
PRACTICAL
FABRIC STRUCTURE

BY
H. NEVILLE
PRINCIPAL OF THE TEXTILE DEPARTMENT
MUNICIPAL TECHNICAL SCHOOL
BLACKBURN

BLACKBURN
R. DENHAM AND CO.
31 KING WILLIAM STREET
LONDON: SIMPKIN, MARSHALL, HAMILTON, KENT AND CO.

ALL RIGHTS RESERVED

1897

TO THE READER

IN the following pages the writer has endeavoured to present to the student, and such as may be interested in the subject of Weaving, a series of consecutive lessons in the Principles of Fabric Structure. For this purpose, and in the belief that where a principle or method has to be taught, simplicity of illustration is the most helpful, no attempt has been made to elaborate the examples given. The free use made of sectional diagrams to show what actually takes place in producing any particular fabric is meant to help the Student in this respect. This work has substantially appeared as a series of papers contributed to "THE TEXTILE MERCURY."

The Author is aware of much that might have been added to make the work more complete, but the urgency of seeing the work through the press, prior to taking up an important commission abroad, must be the excuse for this incompleteness.

H. N.

TECHNICAL SCHOOL
BLACKBURN
JULY, 1896.

CONTENTS

	PAGE
CHAPTER I.	
Introduction...	I
CHAPTER II.	
Principles of Fabric Structure ...	5
CHAPTER III.	
Design Paper and its Uses ...	14
CHAPTER IV.	
Threads ...	17
CHAPTER V.	
Plain Cloth and its Ornamentation ...	21
CHAPTER VI.	
Twilling—Regular, Broken, and Fancy ...	34
CHAPTER VII.	
Drafts and Tie-ups ...	58
CHAPTER VIII.	
Arrangement of Twilled and Satin Patterns...	68
CHAPTER IX.	
Spotting ...	75
CHAPTER X.	
Open Work Effects ...	117
CHAPTER XI.	
Cords and Corded Effects ...	121
CHAPTER XII.	
Pile Weaving ...	129
CHAPTER XIII.	
Backed and Double Cloth ...	158
CHAPTER XIV.	
Cross Weaving ...	193

ERRATA.

Page 32, last line, miss out all from 16 ends 4 in a dent.

PRACTICAL FABRIC STRUCTURE

CHAPTER I

INTRODUCTION

FOR the production of all woven fabrics we are entirely dependent on two sets of threads—warp threads, which run the length of the piece, and weft threads, which go across the piece from side to side—and by the manner in which these threads are interlaced with each other, do we decide upon the character of the fabric we wish to produce, not only as to the build of a cloth, but as to its ornamentation as well.

In all woven fabrics we have design; but to all who have thought about the matter it must be evident that this term may mean either one or other of two things—the design of construction or the design of ornamentation; and while that gives us, as it were, a framework upon or into which something else has to be placed, this presents to us a designing or planning of ornament which shall be adaptable to, and suitable for, the medium to which it has to be applied. By our first we are taught to consider the nature of the material from which our fabric is to be constructed, the uses to which the fabric is to be put, and the utility of our fabric, and with this knowledge to exercise the judgment in selecting ornament which shall not interfere with any of these considerations. But if the second is to have any value at all, its ornament must be planned according to all those well-established rules that govern form, style, and adaptability to the medium upon or into which it is to be placed, and must be suitable to the reproductive capacity of the machines used in its manufacture.

If this is true it must mean that while structural design belongs to, and is the province of the weaver, the designing of ornament is and

belongs to the province of Art. We do not mean by this that the weaver must do without Art, or that Art can do without the weaver—either assertion would be ridiculous; but we simply wish to point out that when we speak of Textile Design we ought to discriminate between its two sections, and so have an intelligent sense of what the term exactly means.

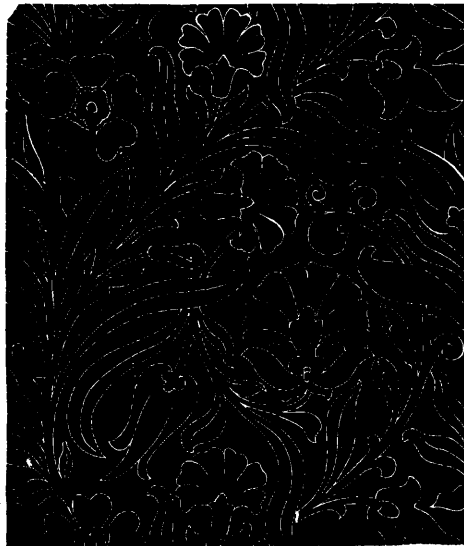

FIG. 1

Let Fig. 1 be a design with which we wish to ornament our cloth. Simple in itself, we will suppose that it has been selected because of its adaptability and fitness; that it has been planned so as to be within the compass of the machine to be used for its reproduction; and that its distribution, its balance, and its style have been planned according to strictly art rules and suitable for the fabric to which it is to be applied. This is what our designer gives to us; but as it stands at present it is only a motive or a suggestion for something. If we transfer it, or some part of it, to design paper, which represents to us the two sets of threads that are to be interlaced with each other, we have Fig. 2.

Even now, though we have transferred this motive for ornamentation to threads of warp and picks of weft, we have no fabric, but rather a mass of threads lying loosely upon each other. It is here

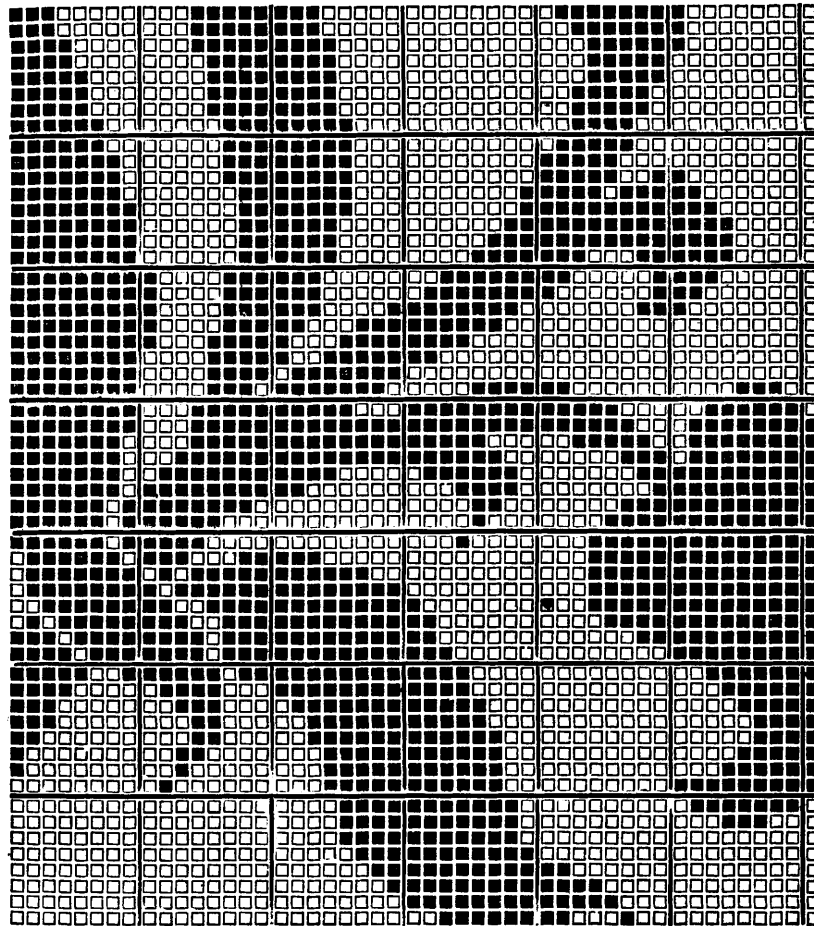

FIG. 2

that the weaver's art is called upon ; and no sooner does he decide upon what principle these threads shall interlace with each other, and mark these intersections upon his design, than we have applied

ornament and structural design giving us a fabric comparatively perfect (Fig. 3). It will be readily seen from this that the "get-up" will make or mar a design, no matter how perfect in its adaptability

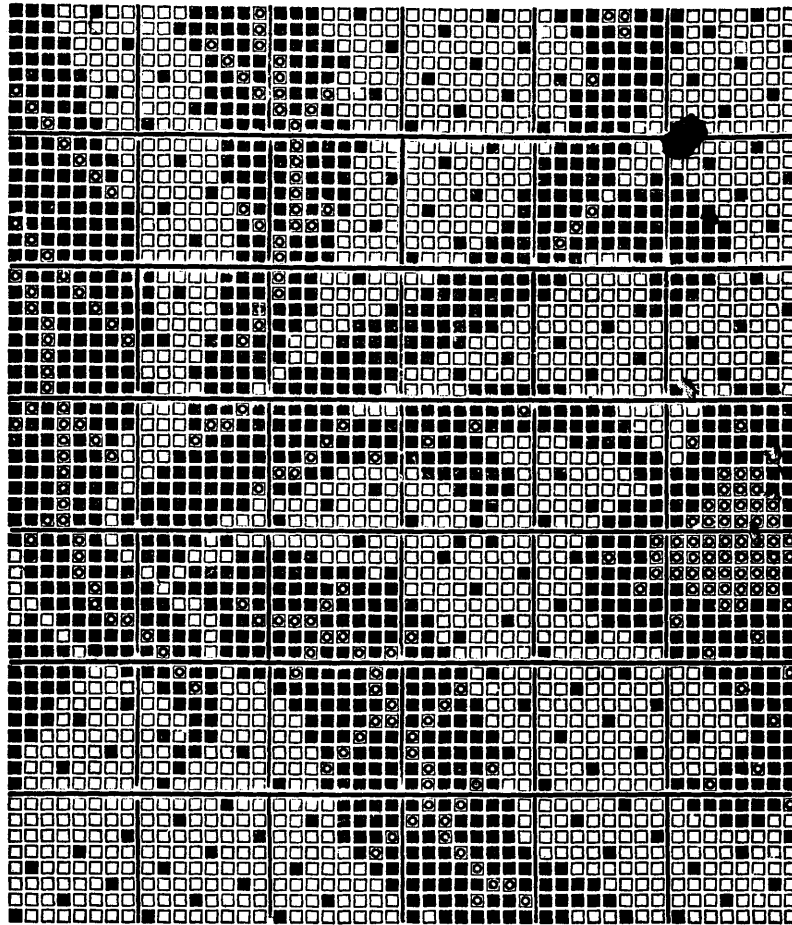

FIG. 3

it may be. Hence the necessity that the "designer" shall have a good knowledge of the principles of cloth structure.

CHAPTER II

PRINCIPLES OF FABRIC STRUCTURE

WE have said that in all woven fabrics we are entirely dependent on two sets of threads, warp and weft, while others (such as knitted or felted fabrics) are readily distinguished by their construction. In knitted fabrics we have only one thread, which forms loops—loop being passed through loop until the fabric is finished; while in felted fabrics no threads enter into their construction, being simply an irregular, interlocking mass of fibres, compressed together while in a moist and heated state. Since this is so simple a matter, it is surprising that writers on weaving do not agree on the classification of woven fabrics; some asserting more elementary principles of construction than others. Murphy, in his “Art of Weaving,” makes six the number of elementary principles—viz., plain cloth, twilling, double cloth, spotting, flushing, and cross-weaving. Ashenurst, in his “Weaving and designing,” has three—viz., plain cloth, figuring, and cross-weaving. Barlow, in his “History and Principles of Weaving,” makes seven, but includes knitting.

For our purpose we shall make five divisions or elementary principles—viz., plain cloth, figure weaving, pile weaving, double cloth, and cross-weaving. This is a near approach to Murphy’s classification, if we make spotting and flushing a sub-division of figure weaving and add pile weaving.

(A). *Plain Cloth* is without doubt the first elementary principle of fabric structure, probably practised for ages before any attempts were made at ornamentation by forming pattern, either in or upon the cloth. Its structure as shown by diagram (Fig. 4) and section

(Fig. 5), is that of alternate threads lifted and depressed on consecutive picks of the shuttle, the two sets of threads working at right angles to each other. Though this is the simplest and most elementary make of cloth, it does not follow that it must be perfectly "plain" in every sense; for, though plain as to structure, it lends itself very readily to ornamentation (1) by means of colour; (2) by using threads of varying degrees of thicknesses; (3) by varying the number of threads in a given space.

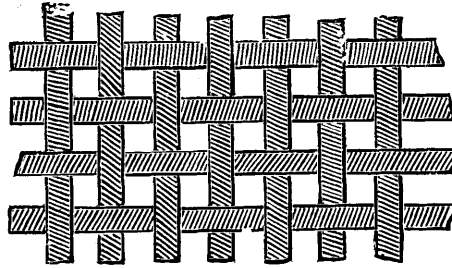

FIG. 4



FIG. 5

For the quantity of material employed this is perhaps the firmest and strongest of all makes of cloth. But, though producing a firm, strong fabric, it can never be made into a very close one. It will certainly be strong, because by this alternate interlacing of the threads each one supports the one next to it, to the very utmost. At the same time it will, to a greater or less degree, be an open, perforated cloth, the perforations varying with the ever-varying conditions of its structure. If we refer to Fig. 5, and neglect the angle of curvature as well as compression, we see that one set of threads are individually kept apart by the thickness of the intersecting thread; and if we grant that all threads of the same counts have equal diameters, then such a fabric must be made up of equal thread and equal space, if we use the same counts of material in both sets of threads, and place an equal number in a given space

both ways. If then, our threads are coarse, we shall have greater perforations than when we use threads of a finer character.

(B). *Figure Weaving*.—Any alteration from the alternate interlacing of our two sets of threads produces figure; and no matter of what form or outline this figure may partake, it is produced either by carrying the warp threads over the weft, or by flushing the weft threads over the warp. In no other division of textile fabrics do we find so great a diversity of cloths as is presented to us by this, ranging as it does in its variety from the simple diagonal rib of the twill, to the most intricately figured outline of some floral design. Figure weaving includes twilling—regular, broken, and fancy; spotting; all kinds of single reversible cloths; diapers; mock-lenos, canvas, hucks, honeycombs, damasks, and brocades.

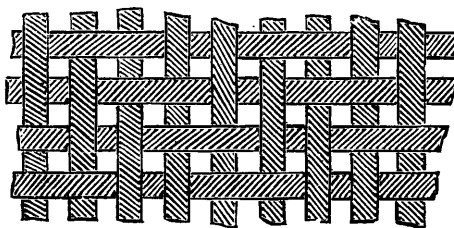

FIG. 6

We may illustrate figure weaving by Fig. 6, where we see that each warp thread is lifted over two picks of weft, and that each pick of weft is flushed over two warp threads. If we increase the number of our warp threads we can increase the size of our pattern; and if we are enabled by some mechanical means to make any selection of warp threads we wish, previous to inserting a pick of weft, then we can make any pattern we like—whatever its outline or form may be. It is this capacity of selection that gives us, in Fig. 6, pattern, a diagonal rib running up and across the cloth, progressing one thread to the left on consecutive picks of the shuttle. This capacity of selection will, of course, depend upon the apparatus used for such a purpose—tappets having the least, jacquards the greatest, scope for pattern production.

(c). *Pile Weaving*.—All pile fabrics are characterised by the threads which issue from a body or ground cloth standing out and away from it, in some cases giving us the soft brushlike surface of velvet, in others the looped surface characteristic of terry towels and Brussels carpeting. In a third kind we have the construction of the latter, but the loops having been cut we get a fabric having a deep, dense pile, such as is found in plush, imitation skins, and Wilton carpets.

Pile fabrics may be either weft or warp—weft, as in weft velvets, plain or figured, and corduroys; warp, as in plush, warp velvets, terry towellings, and pile carpets generally. In the first-named the weft is flushed over the warp threads in such a manner that “races” are formed—a sort of groove which forms a path for the traverse of the cutter’s knife. A section of such a cloth is shown at Fig. 7, where



FIG. 7

B is one of a series of picks forming the pile; A, one of a series forming a ground cloth. In weaving such a cloth a given number of pile picks to one ground pick are put in—say two, three or four. The ground picks being beaten up closely together, the pile picks, being loosely attached to the ground cloth, are forced on the face of the ground cloth, so that upon being cut they stand out and away from the body of the fabric, having been cut at such a place as that marked v.

But these pile picks must be so bound into the ground, that a regular distribution of the pile over the surface of the fabric is ensured. This is shown at Fig. 8, where we have a section of a

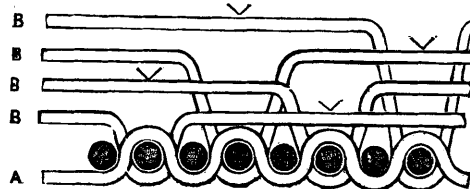

FIG. 8

cloth having four pile picks B B B B to one ground pick A, the v marks showing where each pick would be cut. In the construction of a corduroy we have a modification of this principle, the binding of the pile picks to the

weft threads in such a manner that “races” are formed—a sort of groove which forms a path for the traverse of the cutter’s knife.

modification of this principle, the binding of the pile picks to the

body cloth being so arranged as to cause the pile to form ribs running the length of the piece. This is shown at Fig. 9, a section of a cloth having two pile picks B B to one ground pick A.

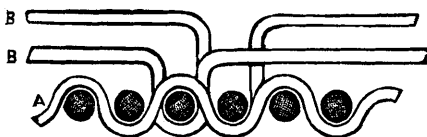

FIG. 9

It might be objected that these (Figs. 7, 8, 9) are merely examples of figure weaving, and that they are not pile fabrics until the cutting takes place, which is a finishing process. But we must not forget that here we have two series of weft threads, which may be of the same or of different materials, and that they do not equally share in making the cloth. One series is used only for the cloth forming the body of the fabric, the second series not forming a fabric, but simply being used for the purpose of giving a soft, brush-like surface to a ground cloth, into which they do not enter constructively, but are attached thereto. In no figure fabric have we the same principle employed.

In warp pile fabrics we have a different construction from the preceding ones, the pile being formed by warp instead of weft. These threads are brought from special beams, through healds or jacquard harness, and while lifted so as to form a shed, a wire is inserted as a pick of weft, upon the withdrawal of which loops are formed that are left standing out from and upon the face of the cloth. This is shown at Fig. 10, where a pile thread is seen forming



FIG. 10

loops at A.A. But the wires used in the formation of these may be made to cut, in which case we have cut pile, as shown at Fig. 11

where A is a pile thread cut by the withdrawing of the wire, and B a thread, one of a series forming the ground cloth. It follows from this that by the use of cutting and non-cutting wires a fabric may be produced of cut and uncut loops, having a pattern produced by these means.



FIG. 11

Another consideration in the construction of these fabrics is that all pile threads may be lifted over every wire inserted, so forming a row of loops going from one to the other side of the cloth, such as Fig. 10, the whole of the pile threads coming from one beam. Or only half the pile may be lifted on consecutive wires, in which case



FIG. 12

the pile threads will be placed upon two beams. Fig. 12 shows this latter arrangement of pile threads, as well as cut and uncut loops. From this it may be safely inferred that pile weaving is a principle of fabric structure.

(D). *Double Cloth*.—Strictly speaking, a double fabric must be absolutely two cloths, though these may be so stitched together during the process of weaving as to form one solid and compact cloth. In either case the single set of warp and weft threads, made up of one series of threads, now becomes multiplied in the series constituting such a set of threads, for we may have one, two, three, or four series of warp and weft threads weaving with each other in such a manner as to form one, two, three, or four separate and distinct or closely compacted cloths. Double-cloth weaving may be said to begin with backed fabrics—cloths which have a sort of

lining woven to them for the purpose of giving increased thickness, weight, or warmth.



FIG. 13

At Fig. 13 is shown a section of such a cloth, where A is a pick of face weft and B a pick of back weft, which, in cloths of this description, may not be either of the same colour or material as that forming the face. Fabrics may be backed with either warp or weft. In producing a reversible fabric such as a two-weft or two-warp tapestry, pattern is produced by colour, a coloured thread forming its portion of the figure and then passing to the opposite side of the cloth, a second thread of another colour picking up where the first one left off. This is shown at Fig. 14, where A is one and B a second coloured thread, thus giving



FIG. 14

reverse colour on opposite sides of the cloth. In many tapestries, not of a reversible character, a great many colours are used, each producing its portion of figure, after which it is thrown to the back of the cloth until required for the other repeats of the figure.

In that class of double cloths represented by such cloths as bags, tubes, etc., we have two separate and distinct cloths, not stitched together except at the edges, as shown

at Fig. 15, where the weft thread A passes alternately from one cloth to the other. Exactly similar to this is the weaving of such goods as woven driving belts, several such cloths being woven at the same time, but so stitched

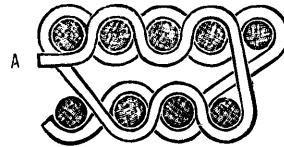

FIG. 15

together as to form one solid and compact cloth. A three-ply plain cloth is shown in section at Fig. 16, A, B, C being the respective

cloths, the threads taken from one to the other showing the method of stitching. At Fig. 17 is a section of a double cloth known as a "pique"—a cloth representative of a vast range of fancy double

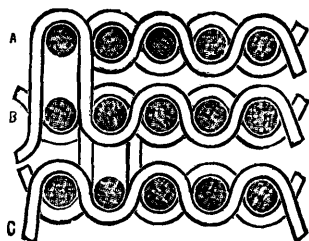

FIG. 16

cloths such as toiletings, quilts, fancy waistcoatings, etc. Here in each set of threads we have several series—warp threads for face and back cloths, A, B, and weft threads for face and wadding. There are many other makes of double cloths which might be shown in a similar manner.



FIG. 17

(E). *Cross Weaving*.—In this class of woven fabrics we have a ready mark of distinction from all other woven goods—the threads do not lie at right angles to each other as in several of the previous cases. This is caused by the partial or entire twisting of the warp threads about each other. These cloths are known as gauze or leno fabrics; gauze, when one end crosses one, with one pick of weft in



FIG. 18

each shed, as shown at Fig. 18, a section, and at Fig. 19, a plan, of such a fabric, where a thick crossing end is shown as lifting first on

the left then on the right hand side of a second thread. In leno weaving this crossing takes place along with the production of some other weave.

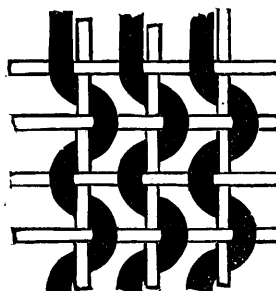

FIG. 19

To ornament such fabrics as these we may use colour or extra material, or vary the manner and order of crossing the threads with each other. While it is impossible to make a very close cloth, owing to our inability to beat up closely the picks of weft, we do get a strong fabric for the amount of material employed, as well as a firm fabric, since one set of threads are incapable of being slid along the other set.

CHAPTER III

DESIGN PAPER AND ITS USES

DESIGN paper is used to convey a clear idea of the build of a fabric, as well as to show how the ornament which we wish to convey to our cloth is to be applied. It is simply a sheet of paper ruled into a series of small rectangles enclosed within a heavy line called a "bar." The longitudinal or vertical spaces represent warp threads, whilst the horizontal ones indicate to us picks of weft. Without any mark placed upon it, it is nothing more than a representation of warp and weft threads lying upon each other, without any interlacing or intersecting having taken place between these two sets of threads. But as soon as we place a mark upon one of these small "squares," we mean that at that particular place a warp thread is lifted up for a weft thread to pass underneath. From this we find that we may place upon our paper a series of "dots," arranged so as to represent the particular form of cloth structure desired, and that this may have any form of outline so long as we have some means of actuating and selecting these threads in this order. Design

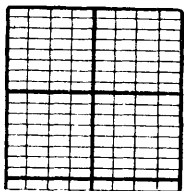

FIG. 20 4 × 8

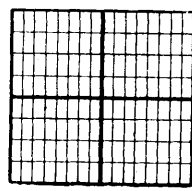
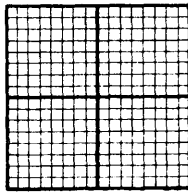
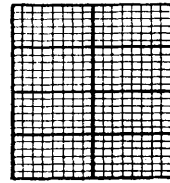

FIG. 21 8 × 4

paper has various rulings—that is, the "bar" may be divided into a varying number of squares, so as to suit the particular class of cloth for which we intend to design—as Figs. 20, 21, 22, 23, which

are ruled 4×8 , 8×4 , 8×8 , and 8×12 respectively. The use of the bar is that it acts as a unit of measurement, as well as a means of calculation. Suppose we wish to make a design on, say, 200

FIG. 22 8×8 FIG. 23 8×12

ends and picks, using 8×8 paper, we should simply have to count off 25 bars in each direction; and so for any other number and ruling.

But this design paper bears a more direct relationship to our cloth than merely measuring the size of a design—it must correspond in its ruling to the number of ends and picks to be placed in a given space of cloth. Suppose our cloth has to contain 80 ends and 80 picks per inch, then the design for such a fabric must be put upon a paper ruled square, say 8×8 . But if our cloth must contain 80 ends and 120 picks per inch, then we must use paper ruled 8×12 , or the design when woven will not be square. To find what ruling is required for such cloths as these we have:—As the required ends per inch are to the required picks per inch, so is the ruling of the paper warp way to the ruling of the paper pick way. Taking the above example we have, as $80 : 120 :: 8 : 12$.

In double-cloth making this is a matter of the utmost importance. Suppose we have to make a cloth with two wefts and one warp, that must have 60 ends per inch and 100 picks per inch, one weft forming the ground portion of the design, the other the figure portion. In such a cloth the picks do not stand side by side, but rather above and over each other, and that we only put 50 picks per inch in the face of the cloth. This being so, our proportion will be, as $60 : (100 \div 2) ::$ ends per inch : picks per inch of the paper used. If, then, the paper we wish to use is ruled 12 to the bar warp way, we shall have, as $60 : (100 \div 2) :: 12 : 10$; our bar must contain 12×10 small squares. Let us take another cloth, where we

have, say, our warp threads in the proportion of 2 face to 1 back, 90 per inch, and our picks in the proportion of 2 face, 1 back, 1 wadding, 132 per inch. Then by the above method of working we shall have

$$90 \div 3 \times 2 = 60 \text{ ends per inch on the face.}$$

$$132 \div 4 \times 2 = 66 \text{ picks } \quad \text{,,} \quad \text{,,} \quad \text{,,}$$

Then by proportion, as 60 : 66 :: 10 : 11 ; or the bars of our paper must contain 10 x 11 small squares.

The colours most used for the painting up of textile designs are the common powder colours, which, mixed with liquid gum will "set" and form a cake. The addition of gum will prevent the colour from being rubbed off the paper. Black, ultramarine, vermilion, white lead, and green are the principal colours used. To prevent designs being soiled, the application of a thin solution of some transparent varnish which dries quickly will allow of them being sponged. The designs should be sized, previous to varnishing, with a solution of gelatine, applied whilst hot.

CHAPTER IV

THREADS

It goes without saying that all threads used for textile purposes have character, and that this character must be taken into account when we begin to design pattern for the ornamentation of woven fabrics. They have strength, and more or less elasticity; they are comparatively coarse or fine; are fibrous or non-fibrous in their structure; and have more or less natural lustre—characteristic peculiarities which the textile designer ought to preserve as much as possible.

In such threads as are composed of the cotton, and woollen fibre, we have threads which are a conglomeration of fibres of varying degrees of length twisted together, and because this staple is so unequal in length, each individual fibre cannot be twisted into the

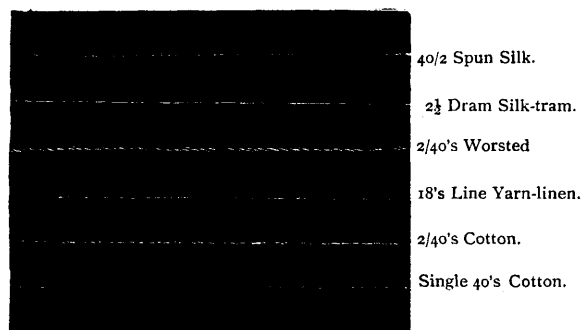

FIG. 24

body of the thread. Hence, a degree of fibrosity is given to the surface of such a thread which cannot be neglected.

At Fig. 24 is shown cotton, worsted, silk, and linen threads of varying degrees of thickness. It will be seen, by comparison, how

fibrous one is as compared with the other. If this means anything at all, it is that by using one kind of thread in preference to another a readier vehicle is found for expressing the detail of any kind of ornament. Suppose we have a design full of minute detail, such as is generally found in silk work, how could this be expressed if we were to employ such threads as are composed of the cotton, woollen, or linen fibre? A want of definition in the outlines of the figure would be the result. And so, in degree, must ornament be planned to suit the comparative fineness or coarseness, as well as the fibrosity of the threads we are to use.

Again, if we take a cotton thread, we find it to be made up of a twisted mass of fibres, which have been doubled and drawn out many times during the several stages of its manufacture, with the object of getting parallelism of fibre and an equality in thickness of the finished thread. And since it is this drawing and twisting of the fibres which ultimately compose the thread and determine its diameter, it is necessary that these operations shall be as perfectly performed as possible, so that the thread shall have a regular succession of sectional areas throughout its entire length, and it is just as necessary that the textile designer shall consider the relative diameters of those threads with which he has to deal before composing the structure of any fabric—he may or he may not place a given number of threads in a given space. Upon this largely depends the comparative perfection of any woven fabric as we shall see when dealing with plain cloth.

We have then to consider the relative diameter of threads themselves. If, for want of better data, we treat threads as true cylinders, then all threads of like diameters will have like areas, and since areas of circles are to each other as the squares of their diameters, then their diameters differ as the square root of their areas. As the count of a thread is simply indicative of its weight and length, a given number of yards of any yarn will equal its counts—a 1's cotton thread of 840 yards weighing 1 lb.

It will be easily seen from this that the diameters of threads vary as the square root of their counts—which will hold good for all threads made from the same material, which are similar in structure, and which have a similar number of twists or turns per inch. But

here we have another matter to deal with. The rule generally given makes no allowance for friction, but simply gives us the number of threads that would lie side by side in a given space if no motion of any kind were given to them. But in actual weaving we have not only the friction of the reed to consider, and the space its metal occupies, but the friction of the threads among themselves when motion is imparted to them. To meet this friction we have certain allowances to make, which are called co-efficients of friction, and they are as follows:—

For cotton, silk and worsted	10%
For woollen	16%

Hence we have—

Rule.—The square root of the yards per pound, minus the co-efficient of friction, equals the diameter of our thread.

Example.—What is the diameter of a 60's cotton thread? By rule,

$$60 \times 840 = \sqrt{50400} - 10\% = \frac{1}{2} \frac{1}{8} \text{ of an inch.}$$

Having found the diameter of one we can, by proportion, find the diameter of any other thread, for if threads of the same counts have like diameters, then must they also have like areas. For example, if our 60's thread has a diameter of $\frac{1}{2} \frac{1}{8}$ of an inch, what is the diameter of a 40's thread?

As these will differ as the square root of their counts, we have:—

$$\text{As the } \sqrt{60} : \sqrt{40} :: 202 : x$$

$$\text{So that } 7.7459 : 6.3245 :: 202 : x$$

Therefore, $\sqrt{60} : \sqrt{40} :: 202 : 165$, the diameter of our 40's cotton thread.

But there is another matter affecting the use of all spun threads which is worth considering. It is often asked—In what direction should a thread be twisted if it is to be used for a figured fabric—say a twill? The generally accepted solution of this problem is illustrated by the following:—Let two threads be placed across each other in the position they would occupy in a woven cloth. It must be very evident that it is the under side of one thread that comes in contact with the upper side of the second thread, and that if these threads are to “bed” into each other the strands of the threads on these faces of contact must run in the same direction. But if, on the other hand, the strands of the threads on these surfaces of

contact oppose each other, the “ bedding ” qualities of the two will be at a minimum—the effect being that the diagonal rib of the twill would be more pronounced than in the first case.

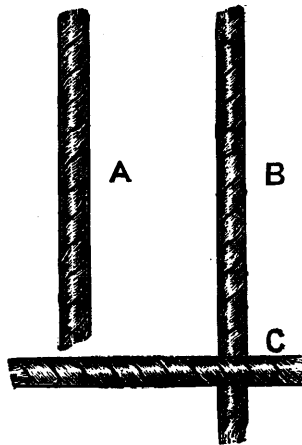

FIG. 25

Let A, B (Fig. 25) be two threads which have been twisted in the same direction, while at C these threads are laid across each other as they would be if woven in cloth. At first sight the twists seem to oppose each other; and they do, as regards their upper surfaces. But twist is put in spirally, so that the strands on the under side of a thread run in the opposite direction to those on the upper surface. If there is any truth in this, it must mean that the strands on the under side of thread C will be in the same direction as the strands on the upper side of thread B, so that ridges of one will fall into the hollows of the other. It will be seen from this that such threads will be less suited to pronounce pattern than those spun in opposite directions.

This is a feature of thread structure often taken advantage of to produce stripe and checkered effects, even in plain cloth, simply by alternating a given number of threads which have been spun in opposite directions—dyed goods in particular having a decided pattern when made from such yarns.

CHAPTER V

PLAIN CLOTH AND ITS ORNAMENTATION

WE have already shown that plain cloth—the simplest form of all fabric structure—is made by the alternate lifting and depressing of warp threads on consecutive picks of the shuttle. We have also seen the use of point paper. Plain cloth, then, may be represented upon such paper, as in Fig. 26, which shows us a pattern complete on two ends and two picks. If a given number of repeats of the pattern were taken, we should have Fig. 27, which shows four repeats warp and weft way.



Fig. 26

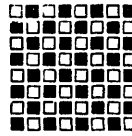

Fig. 27

Probably the only thing worth considering in the construction of our ordinary grey plain cloth, is its comparative perfection with some given standard. We know that plain cloths are presented to us in an almost endless variety, each example having some peculiarity of structure. One set of threads may predominate over the other either in number or in thickness—in number, when we have more threads placed in a given space in one direction than the other; in thickness, when the diameters of one set of threads are not equal to the diameters of the other set.

If we accept the definition given to us by the authorities on weaving of what constitutes a perfect plain cloth, and if we allow that all threads of the same counts have equal diameters, and, therefore, equal areas, then the building of such a cloth is a simple matter. We are told that a perfect plain cloth is a fabric having

“both sets of threads of equal counts, an equal number being placed in an equal space both ways; that the cloth is made up of equal thread and space; and that, owing to the alternate intersecting of these threads, both sets are equally bent out of the straight.” This is called a perfectly “balanced” cloth.

But it must be evident that if we alter the number or the thickness of our threads, we must do so in some given proportion, or our modified cloth will not have the perfection of “balance” observed in our standard fabric. If we decrease the diameters of the threads, then must we increase the number placed in a given space; if we increase the diameters, then must we have fewer of them.

Not forgetting that the diameters of threads vary as the square root of their counts, let us take the following example to illustrate how we may change and yet preserve the balance. Suppose we have a cloth with 60 ends per inch of 30's yarn, and wishing to change to a cloth having 70 ends per inch, what counts of yarn should we use?

By proportion we have, as $60 : 70 :: \sqrt{30} : \sqrt{x}$; so that $60 : 70 :: 5.4772 : 6.39^2$.

Therefore 40's is the counts to be used for our new cloth. But suppose we wish to alter the number of threads in a given space—say from a cloth having 80 threads per inch of 40's yarn to one using 50's yarn, how many threads are we to put in one inch of space? Again working by proportion, we have as

$$\sqrt{40} : \sqrt{50} : 80 :: x ; \text{ so that as}$$

$$6.3245 : 7.071 :: 80 : x ; \text{ therefore } x = 89.44$$

the number of ends to be placed in one inch of our new cloth. In both cases that which applies to warp equally applies to weft threads, and is based upon the fact that “counts vary inversely as to bulk as well as to numbers.”

There is yet another matter of great importance to be considered, viz., contraction—the percentage of shortening that takes place in a thread of a given length owing to its being interlaced with a second series of threads. We have only to remember the variable conditions under which our fabric may be produced to see that this cannot possibly be a fixed quantity. If we alter diameters, if we

make one set of threads predominate over the other, if the tension put upon our fabric while weaving is a variable one, then must this percentage be a variable one. If this were a constant quantity the remaining portion of a calculation to find the quantity of material in or to make a piece of cloth would become an easy matter.

Among the simpler and most generally accepted rules for finding the percentage of contraction for plain cloths we have the following:—

To find the warp percentage:—

Rule.—Multiply picks per quarter-inch by 12 and divide by the counts of weft.

To find weft percentage:—

Rule.—Multiply ends per quarter-inch by 12 and divide by the counts of warp.

Twist and weft from 25's to 50's, and ends and picks from 10 to 20 per quarter-inch. For higher picks 13 must be taken as the multiplier.

Example.—What is the percentage of contraction for a plain cloth having 16 ends and 16 picks per quarter-inch of 32's twist and 36's weft?

$$\text{I. } 16 \times 12 \div 36 = 5.33 \text{ per cent. for warp.}$$

$$\text{II. } 16 \times 12 \div 32 \times 6.0 \quad ,, \quad ,, \text{ weft.}$$

This rule is not quite applicable to all cases, but the conditions to which it will not apply are very rare indeed, more particularly if we keep within medium counts of material and medium ends and picks placed in a given space of our cloth.

Shrinkage or contraction may be of two kinds—normal, or reciprocal shrinkage, which is found in all classes of cloths where the two sets of threads are bent somewhat equally out of the straight; and abnormal or one-sided shrinkage, where one set of threads, predominating over the other does all the bending, the second set lying in a comparatively straight line. The first is represented by such as plain cloth; the second by such cloths as cords, reps, and some satins.

Staub, in his *Textile Ready Reckoner*, gives the following rules for finding the contraction due to normal shrinkage.

For cloths where the shrinkage is normal:—

To find percentage of warp shrinkage :—

I. *Rule.*—The picks per quarter-inch squared multiplied by the co-efficient, and divided by the counts of weft.

To find percentage of weft shrinkage :—

II. *Rule.*—The ends per quarter-inch squared multiplied by the co-efficient, and divided by the counts of warp.

The co-efficients used in these rules are—for cotton, 0.567; for wool, 0.88; for linen, 1.6.

Example.—A piece of cloth is to be made of 30's warp and 36's weft, 16 threads and 18 picks per quarter-inch; what is the contraction in width and length?

$$\text{I. } \frac{18 \times 18 \times 0.567}{36} = 5.108 \text{ per cent. for length.}$$

$$\text{II. } \frac{16 \times 16 \times 0.567}{30} = 4.838 \text{ per cent. for width.}$$

It will be noticed that the percentage of contraction increases as the ends or picks increase. But we know that there is a limit to this because we can ultimately arrive at that point where both sets of threads are not equally bent out of the straight, so that these rules do not apply when we have to deal with abnormal or one-sided shrinkage. To meet these cases the same authority gives the following rules :—

To find warp contraction—the weft straight :—

I. *Rule.*—Picks per quarter-inch squared multiplied by co-efficient, and divided by a number corresponding to the sum of the diameters of the counts employed.

To find weft shrinkage—the warp straight :—

II. *Rule.*—Ends per quarter-inch squared multiplied by co-efficient, and divided by a number corresponding to the sum of the diameters of the counts employed.

Example.—What is the warp shrinkage in a piece made as follows :—15 picks per quarter-inch of 16's weft, and 30 ends per quarter-inch of 36's warp?

We find that the diameter of a 16's thread is $\frac{1}{16}$ of an inch, and that of a 36's thread to be $\frac{1}{36}$ of an inch; so that the sum of these

diameters equal $\frac{1}{104} + \frac{1}{157} = \frac{1}{63}$, and a thread having this diameter is equal to nearly 6's yarn.

Then by rule we have :—

$$I. \frac{15 \times 15 \times 0.567}{6} = 21.262 \text{ per cent. for warp shrinkage.}$$

And so in a similar manner may be found the shrinkage for weft when the warp is straight.

Let us now see how our plain cloth may be ornamented.

(A). *By Using Threads of Varying Thickness.*—Perhaps the most familiar example of this method of ornamenting plain cloth is the common cord, the cord running across or, may be, the length of the piece of cloth. This effect is arrived at by making one set of threads predominate over the other, for we may so dispose of our threads as to cause one set to lie in a perfectly straight line, the second set doing all the bending. Suppose we place our warp threads very closely together, reducing their diameters correspondingly, and insert a weft of a thick, coarse character, we should have this weft lying in a straight line, forming a cord running across the cloth from selvedge to selvedge. Such a cloth is shown by Figs. 28 and 29, where 28 shows sections of weft, and 29 sections of warp threads. Similarly, if we make the weft threads to predominate, then the cord would run in the opposite direction.



FIG. 28



FIG. 29

This method of ornamentation may be carried to very great lengths, by arranging cords so as to oppose each other in direction, and by placing cords of various sizes side by side, by which we produce effects having no appearance of plain cloth, but which, upon analysis, are found to have a truly plain cloth basis. The side and cross borders of pocket-handkerchiefs and corded

checks present examples of this class of weaving, the cords running the length of the piece being made by placing several ends in one heald, while the cords which go across the piece are the

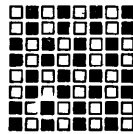

FIG. 30.

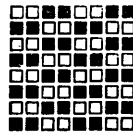

FIG. 31.

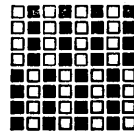

FIG. 32.

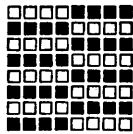

FIG. 33.

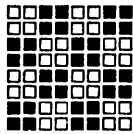

FIG. 34.

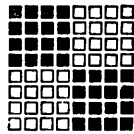

FIG. 35.

result of putting several picks in one shed. Figs. 30 to 35 are examples of cords and small matting effects produced by this method.

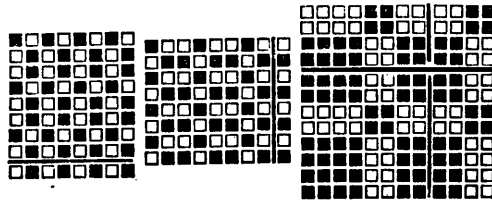

FIG. 36.

FIG. 37.

FIG. 38.

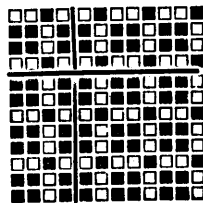

FIG. 39.

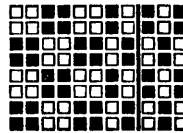

FIG. 40.

But there is no reason why two or more of such workings should not be placed together and so produce a still greater variety of pattern, such as are shown by Figs. 36 to 44 inclusive.

If we employ a suitable shedding motion we can produce still more elaborate results—diagonal cords, curved cords, as well as detached figures placed regularly or irregularly over the face of our

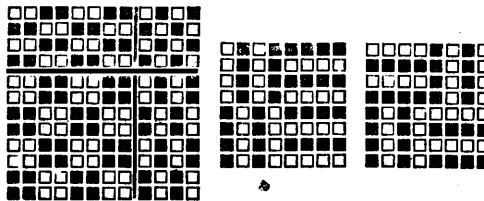

FIG. 41.

FIG. 42.

FIG. 43.

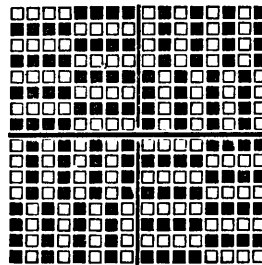

FIG. 44.

cloth ; as, for example, Fig. 45. If colour is used for this class of cloth, the effective display of pattern is considerably heightened.

(B). *Ornamented by Means of Colour.*—By this method, pattern is not produced by grouping threads together, as in our last method, but by using variously-coloured threads, pattern entirely depending on colour, as each individual thread alternately interlaces with the weft. The pattern may assume a stripe form running the length or the width of the piece, or a check form if we use coloured weft as well as coloured warp threads.

Suppose we have a warp, alternate threads of which are blue and red, and that we indicate such an arrangement by Δ , Fig. 46, where solid black indicates the blue, and crosses the red threads. Marking the action of the warp threads by dots of their own colour, we have Fig. 46—a perfectly plain cloth. But we must use weft of

some sort, and it must be evident that such weft as we use will show on the face of the cloth above such warp threads as have been left down. It follows that if we paint in the blank squares

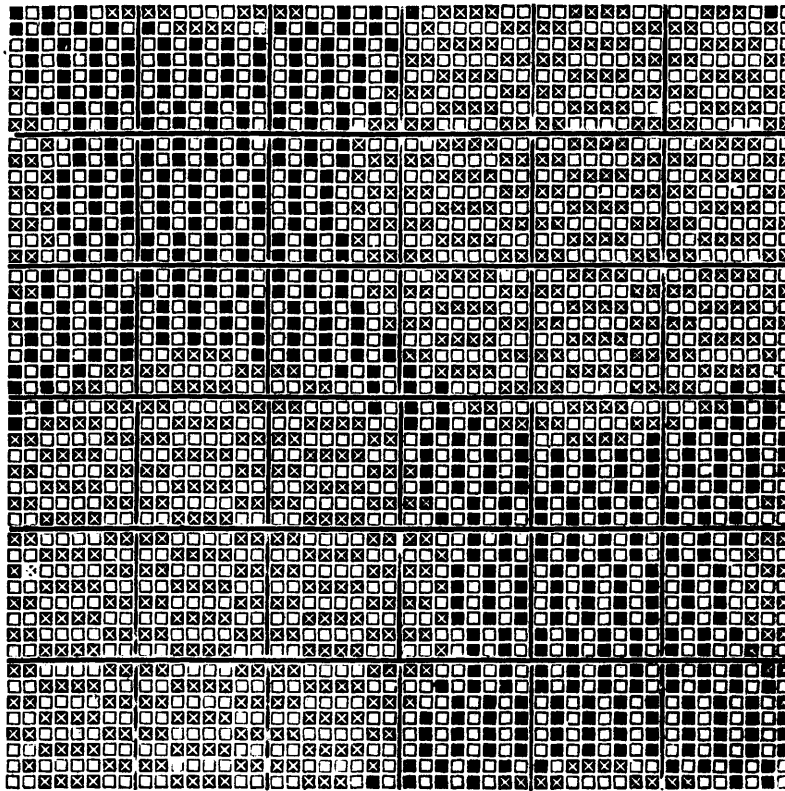
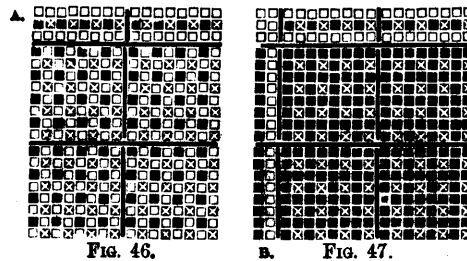

FIG. 45

with the colour of the weft used, we shall have an exact representation of our cloth. Fig. 47 shows us this. Here we have taken our Fig. 46 and thrown in blue weft, as indicated by the line B, so that we have a cloth composed of lines of solid colour running the length and breadth of the piece.

Again, let us take the same arrangement of warp and put it in a box loom, by which we are enabled to throw in any kind of coloured weft—say alternate picks of blue and red, the blue pick

being thrown in when the red warp threads are down. We shall have Fig. 48, where alternate solid bars of colour run across the cloth. But if when the blue pick is inserted the red warp threads



are up, we shall find the stripes running the length of the piece, as shown at Fig. 49.

The procedure, then, for arranging these coloured effects is:— Indicate along the top and down the side of your design the scheme of colour you intend to use. As the cloth must be perfectly plain, put on the paper the plain working of the warp threads in

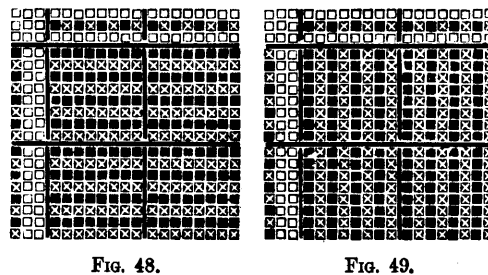

their own respective colours. Having done this, fill in the blank squares with the colour of the pick inserted, and you have an exact representation of the cloth. The value of this method of working is, that you are enabled to see the value and proportion of the colour, as well as the exact form of figure to be produced. Figs. 50 to 55 are small examples of this class of pattern, the arrangement of warp and weft threads being:—

Fig. 50: Warp, two ends of red and two of blue; picks in the same order.

Fig. 51 : Warp, two ends of red and one of blue ; picks, two of red and two of blue.

Fig. 52 : Warp, two and two of red and blue ; picks, one red and one blue.

Fig. 53 : Warp, two blue and one red : picks, alternately blue and red.

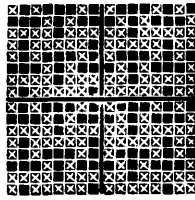

FIG. 50

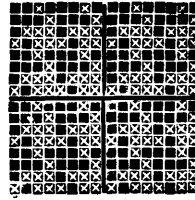

FIG. 51

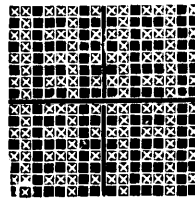

FIG. 52.

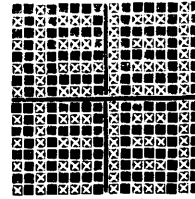

FIG. 53.

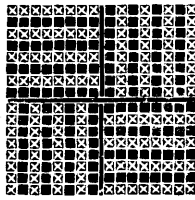

FIG. 54.

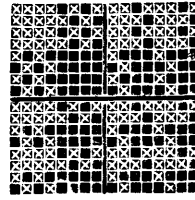

FIG. 55.

Fig. 54 is a checkered effect produced by changing the order of ends and picks. The first eight ends and picks are alternate red and blue, but the second eight are alternate blue and red.

Fig. 55 : Warp, four red, four blue, two red, two blue ; weft same as warp.

From these few examples it will be seen how readily the colour scheme of any cloth may be represented on point paper. Students

are sometimes troubled, though, in finding the amount of each colour in a striped or checked piece of cloth, particularly for the weft.

Suppose we have a piece, the pattern weft way being 50 white, 2 red, 4 white, 2 blue, 4 white, 2 red. First find the total number of hanks of weft in the piece, just as if one colour only were being used, and suppose we have 300 hanks. Then

Rule.—Multiply the total hanks by the number of picks of one colour in a pattern, and divide by the total picks in a pattern. This will give the total hanks of that colour in the piece.

Taking the given example, and working by the rule, we have

$$300 \times 58 \div 64 = 271.8 \text{ hanks of white.}$$

$$300 \times 4 \div 64 = 18.7 \text{ ,, red.}$$

$$300 \times 2 \div 64 = 9.5 \text{ ,, blue.}$$

300.0 hanks.

(c). *Ornamenting by varying the number of Ends or Picks in a given space.*—Weft way this is an easy matter. We have only to vary the rate at which the cloth is being taken forward to produce a stripe or stripes of any width and closeness. But if our stripe has to run warp way, other arrangements must obtain, for such a pattern is produced by “cramming” more threads in one place than another. Let Fig. 56 represent such a pattern, where A is the ordinary and B the “crammed” portions of the cloth. If A is

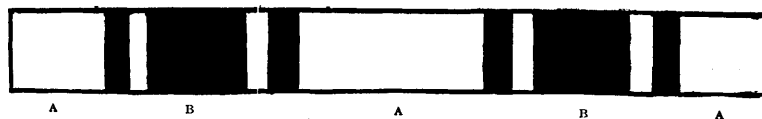

FIG. 56

made up at the rate of 64 and B at the rate of 128 ends per inch, then it must mean that that part of the reed containing B must have four ends in a dent if A is drawn in two ends in a dent. It also means that the healds must be arranged to suit the varying rates per inch of such setting.

The healds for making our given and similar patterns may be arranged—(A) By using a set of healds equal in counts to the finer

portion of our cloth, and dropping them for the coarser parts. (B) Knitting our healds at a given rate per inch, according to the requirements of the pattern. To do this, make a plan of the heald staves, Fig. 57, mark off the repeats as well as the various parts of the pattern, and then mark the number of healds on each staff in each division of the pattern, according to the counts of the reed used. (c) Knitting our healds as spaced healds, by which the "crammed" portion of our pattern would be made by placing the healds on a second set of staves, as shown at Fig. 58, by which the number of heald staves are multiplied. We know that all these staves are not necessary for the weaving of plain cloth, but the method shown is equally applicable to all kinds of striped work, whatever the pattern may be.

Inches.													
	$\langle \frac{1}{2} \rangle$	$\frac{1}{8}$	$\frac{1}{8}$	$\langle \frac{1}{2} \rangle$	$\frac{1}{8}$	$\frac{1}{8}$	$\langle 1 \rangle$	$\frac{1}{8}$	$\frac{1}{8}$	$\langle \frac{1}{2} \rangle$	$\frac{1}{8}$	$\frac{1}{8}$	$\langle \frac{1}{2} \rangle$
4	8	4	2	16	2	4	16	4	2	16	2	4	8
3	8	4	2	16	2	4	16	4	2	16	2	4	8
2	8	4	2	16	2	4	16	4	2	16	2	4	8
1	8	4	2	16	2	4	16	4	2	16	2	4	8

FIG. 57

Inches.													
	$\langle \frac{1}{2} \rangle$	$\frac{1}{8}$	$\frac{1}{8}$	$\langle \frac{1}{2} \rangle$	$\frac{1}{8}$	$\frac{1}{8}$	$\langle 1 \rangle$	$\frac{1}{8}$	$\frac{1}{8}$	$\langle \frac{1}{2} \rangle$	$\frac{1}{8}$	$\frac{1}{8}$	$\langle \frac{1}{2} \rangle$
8	8		2		2		16		2		2		8
7	8		2		2		16		2		2		8
6	8		2		2		16		2		2		8
5	8		2		2		16		2		2		8
4		4		16		4		4		16		4	
3		4		16		4		4		16		4	
2		4		16		4		4		16		4	
1		4		16		4		4		16		4	

FIG. 58

Our next consideration is the number of ends in the width of a piece when the reed is irregularly dented. Let us take our pattern Fig. 56 as an example, to see how many ends we should have, supposing such a piece to be woven 40 in. wide in the reed. We see by Fig. 57 that our pattern consists of 64 ends 2 in a dent, 16 ends 4 in a dent, 8 ends 2 in a dent, 16 ends 4 in a dent, 8 ends 2 in a dent,

64 ends 4 in a dent, 8 ends 2 in a dent, and 16 ends 4 in a dent; so that the whole pattern occupies 64 dents. If our reed is a 64 Stockport, we shall have 1,280 dents on 40 in.; so that $1,280 \div 64$ (the number of dents occupied by one pattern) gives us 20 patterns in the width of our piece. Consequently the number of ends in the pattern, multiplied by the number of patterns in width, gives us 3,520 ends in the width ($176 \times 20 = 3,520$). These considerations will meet the requirements of any kind of irregularly striped and dented goods.

CHAPTER VI

TWILLING—REGULAR, BROKEN, AND FANCY

WE have said (Chap. II., sec. B) that any departure from the alternate interlacing of two sets of threads produces figure; and no matter of what form or outline this figure may partake, it is produced either by carrying the warp threads over the weft, or by flushing the weft threads over the warp.

The simplest form of figure we can produce is given to us by twilling, which is characterised by a diagonal direction of pattern running up and across the cloth, and which may run either from right to left or from left to right. Twilling is conducive to a close and, may be, heavy fabric; for it enables us to place more material in a given space than we possibly could do by the alternate interlacing of threads, owing to lessening the number of intersections. This will be seen by comparing Fig. 59 with Fig. 60.



Fig. 59



Fig. 60

In Fig. 59 we have seven ends intersected by a pick of weft in plain cloth order, consequently we have seven intersections; but in Fig. 60 we have seven ends intersected by a pick making only four intersections, so that in the latter the threads could lie closer together, and so we could put more of them in a given space.

Twilling is divided into Regular, Broken, and Fancy, each possessing characteristics all its own.

(A). *Regular Twills* are diagonal effects produced by lifting consecutive ends on consecutive picks of the shuttle, the pattern progressing one thread to the left or right for every pick put in. The simplest of these is the three-end twill, where for the first pick of the pattern the first end is lifted up; for the second pick, the second end; the third pick, the third end, and so for any other regular twill. In all cases the number or name given to a pattern is the measure of that pattern, and indicates the number of ends or picks upon which we have one complete repeat of such a pattern. At Figs. 61 to 66 inclusive we have regular twills, from the three to the eight end. These may be produced up to and including sixteen ends and picks.

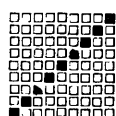
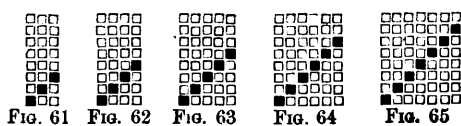

FIG. 66

(B). *Satins, or Broken Twills*, are derived from the regular twills. By taking a regular twill as a base pattern and re-arranging its

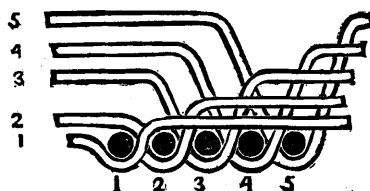
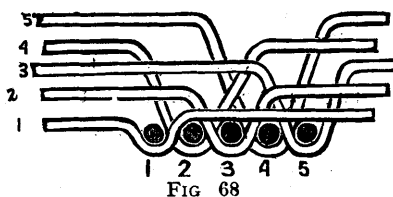

FIG. 67

binding points we produce a comparatively patternless cloth, in which the diagonal rib characteristic of a twill is destroyed, the cloth presenting a smooth even surface. Let us take the five-end regular twill and see how this is converted into a five-end satin.

At Fig. 67 is shown a section of the twill, and it will be seen that consecutive picks of weft interlace with consecutive warp threads—1, 2, 3, 4, 5 picks interlacing with 1, 2, 3, 4, 5 warp threads respectively. But in Fig. 68—a section of our five-end satin—we have consecutive picks 1, 2, 3, 4, 5 interlacing with alternate warp



threads 1, 3, 5, 2, 4 respectively, which gives us an all-over distribution of weft on the face of the cloth. It will be evident, then, that satins cannot be made by an indiscriminate selection of binding points, but by the following rules all satins can be made, with the exception of the four and six end.

Rule I.—The least number that is not a measure of the satin to be made equals the intervals. This applies up to the eight-end satin. For more than eight ends, the second number that is not a measure is used.

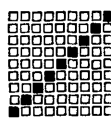

FIG. 69

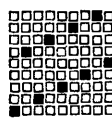

FIG. 70

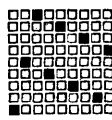

FIG. 71

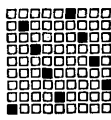

FIG. 72

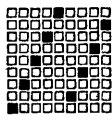

FIG. 73

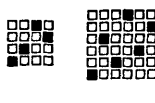

FIG. 74 FIG. 75

Rule II.—Divide the number of ends on which the satin is to be made into two unequal parts, so that one shall not be a measure of the other, and shall not be divisible by a common number.

Perhaps Rule II. is best to work by, though both are used. Suppose, then, we wish to make a satin on nine ends and picks. If we divide nine, as per Rule II., we have 2 and 7 or 4 and 5, all

of which numbers may be taken as intervals in constructing this satin, as shown at Figs. 69 to 73, where 69 is the regular twill from which the four arrangements of satin are taken, Fig. 70 being the two interval, Fig. 71 the seven interval, Fig. 72 the four interval, and Fig. 73 the five interval.

Satins are divided into perfect and imperfect—perfect when they conform to the rule for their construction, and imperfect when they do not do so. The satins on four and six ends are imperfect. Of the four-end there is only one possible arrangement, Fig. 74, and the best practical arrangement of the six-end is Fig. 75. Below is appended a table of intervals which may be used in making various satins.

TABLE OF SATINS						
Satin.	Intervals that may be used.					
4 end ...	Imperfect					
5 „ ...	2 or 3					
6 „ ...	Imperfect					
7 „ ...	2 or 5	3 or 4				
8 „ ...	3 or 5					
9 „ ...	2 or 7	4 or 5				
10 „ ...	3 or 7					
11 „ ...	2 or 9	3 or 8	4 or 7	5 or 6		
12 „ ...	5 or 7					
13 „ ...	2 or 11	3 or 10	4 or 9	5 or 8	6 or 7	
14 „ ...	3 or 11	5 or 9				
15 „ ...	2 or 13	4 or 11	7 or 8			
16 „ ...	3 or 13	5 or 11	7 or 9			

Of course this method of satin-making may be applied to either weft or warp-faced satins.

But there are other divisions of satin weaving which give us interesting examples of cloth structure, especially when combined with other weaves, such as

Double Satins—a construction of satin cloth which gives a perfectly reversible fabric, that may have two weft or two warp faces, and which may be of the same material and colour on both sides, or of different materials or colours on opposite sides of the cloth. Suppose we arrange ten picks of a five-end satin so that alternate picks are thrown to the back and face of the cloth, as shown at Fig. 77. It will be seen that two weft faces are produced by all the odd-numbered picks going to the back, and the even-numbered ones to the face of the cloth, as in section Fig. 76. Then, all that is needed is that care must be exercised in selecting the binding points of the two sets of picks, or else they will show through on the opposite side of the cloth. The binding of a back pick must be made so that the floating material of the face comes on each side of it, the binding point of a face pick so that the floating of the back picks will cover it. Figs. 77, 78, and 79 are examples of weft, and Figs. 80, 81, and 82 examples of warp fabrics of this class.

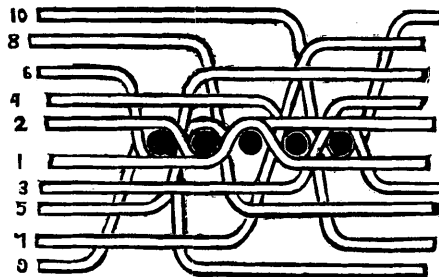

FIG. 76

Oatmeal Cloths.—These form a class of fabrics which present a rough pebbly effect on the face of the cloth, totally unlike any satin fabric. Yet they are made on a satin basis by combining and placing on the top of each other satins of various

sizes. Giving one example to show this method of construction, and taking as base patterns the four, the six, and the eight end ordinary weft satins, we have :—

First find the number of ends and picks required for the new

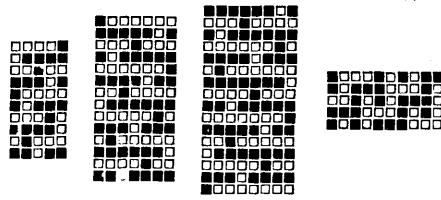

FIG. 77 FIG. 78 FIG. 79 FIG. 80

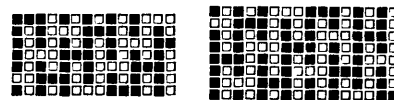

FIG. 81 FIG. 82

pattern, which will be represented by the least common multiple of the numbers employed in the base patterns—in this case twenty-

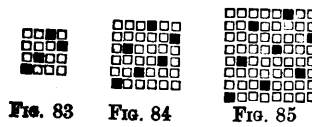

FIG. 83 FIG. 84 FIG. 85

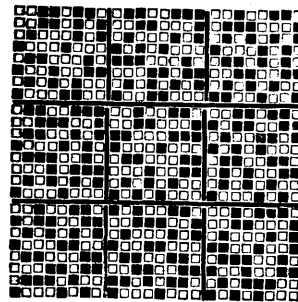

FIG. 86

four. Marking off these ends and picks, first put on one of the satins, then the second, and finally the third. This is shown by Figs. 83, 84, 85, and 86, where the first three are the base patterns and the last the derivative made by putting them together.

Granite Patterns.—A method of producing small broken effects—which may be used as all-over weaves, or as ground weaves for large figures—is by using an ordinary satin as a base pattern, and ornamenting it in some regular order by adding other dots to those which stand for the rising marks of such a pattern. Any satin may be used as a base pattern, but the larger ones, of course, give more scope to the designer. Figs. 87 to 89 are examples of this class of pattern. The solid block dots represent the base patterns, the crosses the additions.

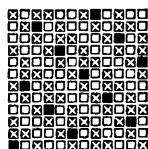

FIG. 87

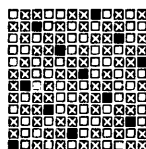

FIG. 88

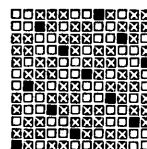

FIG. 89

There are other divisions of satin weaving, such as the reversed satin arrangement for damask weaving, the weaving of diapers, and the production of shaded effects, which will be dealt with later on.

(c). *Fancy Twills.*—A fancy twill is a combination of twill and figure, and may be divided into Regular and Irregular—Regular when the same number of warp threads are lifted on consecutive picks, the pattern progressing to the right or left by a regular succession of warp threads lifted and depressed; Irregular when the number of warp threads lifted on successive picks are variable, and the pattern does not make any regular progression. Offering, as this division of twill weaving does, so great a scope to the textile designer, let us examine in detail the methods of making fancy twills.

- (1) By reversing the direction of a twill.
- (2) By making one point of reversion longer than another.
- (3) By reversing the order of interlacing.
- (4) By altering the angle to produce steep and reclining twills.
- (5) By running one pattern between the diagonal ribs of another.
- (6) By placing two twills side by side.

(7) By combining two or more twills, either end and end or pick and pick.

(8) By re-arranging in satin order.

There are many other fancy twills, such as broken, skip, and corkscrew, each of which will be noticed in their proper place.

By the first method we can take any regular twill as a base pattern, and running it in one direction to its full extent, centre it, so that the diagonal rib will run in the opposite direction, as at Fig. 90, where the first eight ends are the base, and the first fourteen

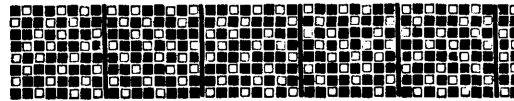

FIG. 90

ends one complete repeat, of the new pattern. By this reversal of the pattern, the continuous diagonal rib of the regular twill has been destroyed, and a "waved" effect produced which runs across the cloth from one side to the other.

But this reversing of the direction of a pattern may take another form. The rising marks of the reversed portion may be arranged so as to come opposite to the sinking marks of the base pattern, of which kind of reversing Fig. 91 is an example. This is known as "locking," and gives a clear definiteness to the outlines of a pattern, because what would otherwise be long floats of loose material are stopped at the changes of the pattern. Of course it is not any regular twill that can be arranged this way.

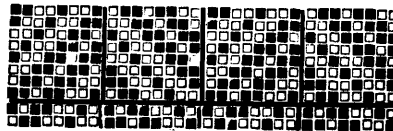

FIG. 91

The second method is like the first, as far as the reversing of the pattern goes, and the using of some regular twill as a base. But on referring to Fig. 92 it will be seen that the several reversings are of varying lengths, and that though by this means

we get a comparatively large pattern end-way it is complete on a very few picks. These reversings may be carried to any length, and so far that one repeat of the pattern may occupy the whole width of the cloth, simply as an effect of "drafting."

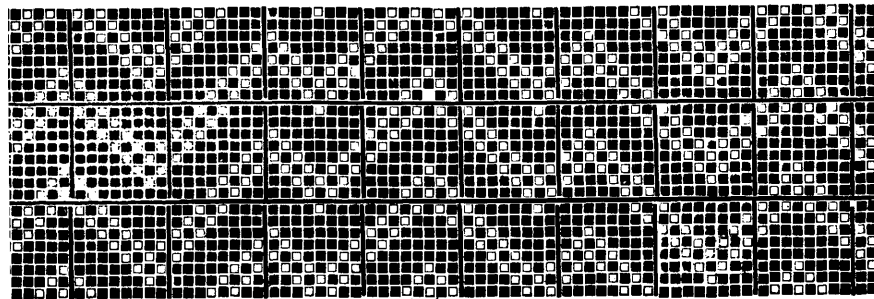

FIG. 92

But many of these patterns may be arranged so that the rising marks of one part will "lock" the sinking marks of the other, as shown at Fig. 93, and may, similarly with Fig. 92 have the reversings carried to any length.

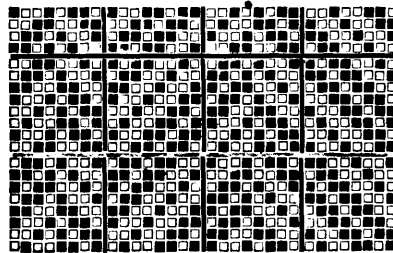

FIG. 93

The third method gives a perfectly reversible cloth, as far as pattern is concerned, by a succession of weft and warp faces, the cloth being of the same construction throughout. Fig. 94 is a pattern on eight ends and four picks, the first four ends making weft twill, while the second four are making warp twill. It will be seen at once that when we have warp on the face, we have weft on the opposite side, and that when we have weft on the face we have warp on the reverse side, as shown by the plan, Fig. 95, by a continuous

weaving of which a stripe pattern would be produced running the length of the piece. But suppose that after a given number of picks have been inserted, these weaves are made to change places, so that what has been warp becomes weft, and weft warp, as in Fig. 96, the stripe form of pattern is stopped, and we have, instead, a checkered or dice effect produced.



FIG. 94

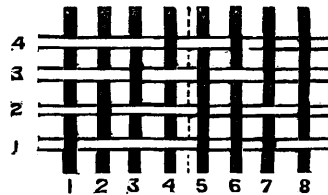

FIG. 95

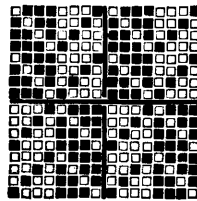

FIG. 96

It is this transition from weft to warp and from warp to weft which gives us such fabrics as diapers (Fig. 97), shaded effects (Fig. 98), and damasks. The construction of these cloths may be based either upon a regular twill or a satin, as instanced by our last two examples.

By the fourth method of making fancy twills an entirely new class of fabrics is presented to us, having characteristics not possessed by any other kind of twills. In all previous examples the patterns have had an angular direction, one way or the other, of 45deg. But patterns made by this method run off at a greater or less degree of angularity than this, and are known as steep and reclining twills. Fig. 99 is a regular fancy twill, on 16 x 16, to be used as a base pattern. Taking the alternate threads, 1, 3, 5, 7, 9, 11, 13, 15, and placing them together, we have the derivative steep twill (Fig. 100) complete on half the number of ends used in the base. And this proceeding holds good for all steep twills of 63° where an even number

of ends are employed in the base pattern. But this is modified when we have an odd number of ends in the base pattern. We need all the ends to produce the derivative pattern, but they must be taken alternately. Fig. 101, a pattern complete on fifteen ends and picks, is the base pattern. Taking the threads alternately, 1, 3, 5, 7, 9, 11, 13, 15, 2, 4, 6, 8, 10, 12, 14, we have Fig. 102. And so we have—

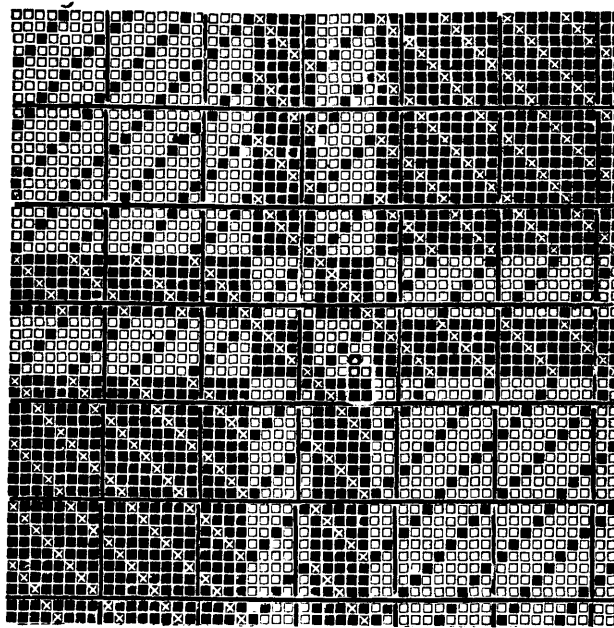

FIG. 97

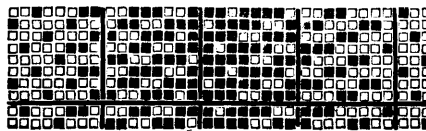

FIG. 98

Rule.—A steep twill of 6_3° derived from a base pattern having an even number of ends is complete on half that number. A steep twill of 6_3° derived from a base pattern having an odd number of ends requires every thread of the pattern, taken alternately, for its completion.

For reclining twills the same method is followed, except that picks are taken instead of ends.

Offering, as it does, the greatest possible scope for the exercise of the designer's art in the production of twill patterns, our fifth

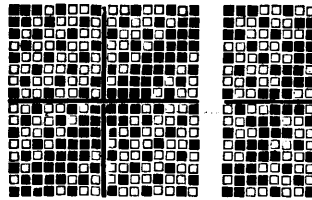

FIG. 99

FIG. 100

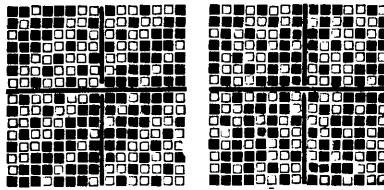
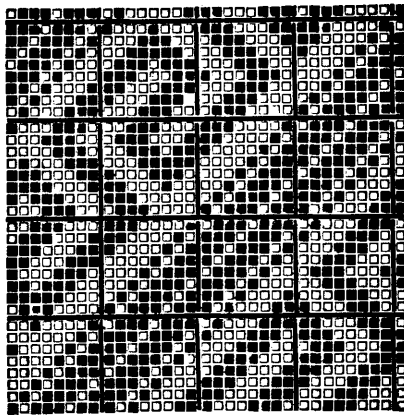

FIG. 101

FIG. 102



A.

FIG. 103.

B.

method of fancy twill making is a simple matter of procedure. We have only to remember, that if we place side by side several patterns, each one complete on different numbers of picks, it will be necessary to carry forward the whole, so that

they are complete at the same time, and, if this is done, the several patterns we use for the evolving of a new one may be as diversified in character as we please. Of course the diagonal direction of pattern must be maintained. Let Fig. 103 represent such a pattern, where A is a fancy regular twill complete on thirty three, and B a small key pattern complete on eleven picks; then the whole is complete on thirty-three picks. Again, in Fig. 104 we

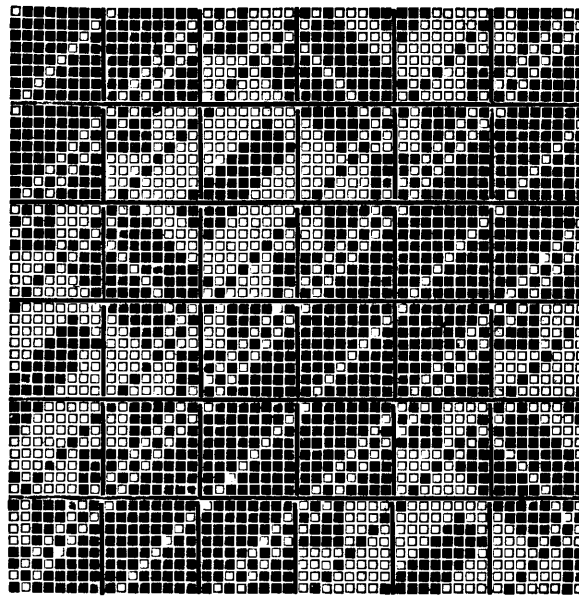

FIG. 104.

have a fancy regular twill on forty-eight; running along with it is a small saw-tooth pattern on four; while between the diagonal bars of the base pattern we have reversed bars of twill making a pattern on sixteen. The whole is complete on forty-eight picks, being the least common multiple of all the numbers employed. In this manner any number of patterns may be combined care being taken, of course, to count every pattern so employed on the diagonal—not across from side to side.

Our sixth method—that of placing two twills side by side—destroys the continual diagonal direction of the new pattern, and

gives stripes running the length of the piece. But care must be taken in selecting and arranging the patterns. Select patterns whose warp threads make the same, or as nearly as possible the same, number of intersections, and arrange them so that they “lock” each other, and so prevent long weft floats. Figs. 105 and 106 are patterns of this class.

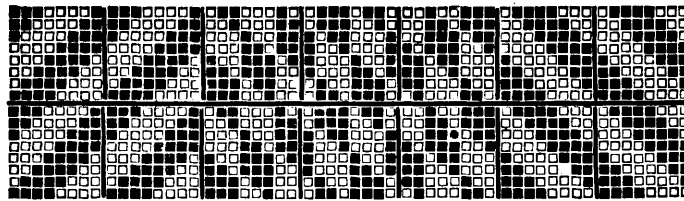

FIG. 105

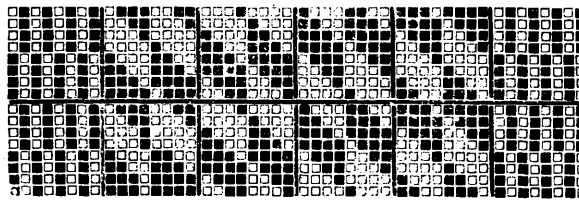
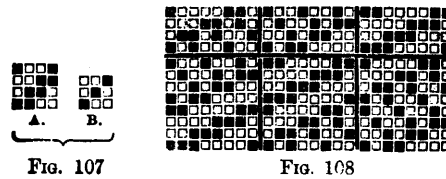

FIG. 106

Combining two or more twills end and end or pick and pick, our seventh method of fancy twill making is as productive of beautiful effects as it is interesting to the textile student. Though the patterns may occupy but few ends and picks, and though the method is more suited for the production of small broken effects than anything else, yet it is one that gives us vast variety, because patterns may be combined which have an equal or an unequal number of ends and picks in their repeats.

Let A, a four-end twill, and B, a three-end twill (Fig. 107), be two patterns which we wish to combine end and end. First find the number of ends and picks on which the new pattern will be complete. Since we are combining them end and end, then the least common multiple of the two numbers will equal the number of picks required, and the least common multiple multiplied by two,

the number of ends required—viz., twelve picks and twenty-four ends. Marking off this number of ends and picks, begin by taking one of the patterns and putting it on the alternate ends, say all the odd-numbered ones; then take the second pattern and put it on the other alternate ends—the even-numbered ones. Treated in this manner, A, B, Fig. 107, give us our new pattern, Fig. 108. In the



same manner, A, B, Fig. 109, give Fig. 110, and A, B, Fig. 111, give Fig. 112. In combining two patterns pick and pick, alternate picks of the base patterns are taken, as illustrated by A, B, Fig. 113, Fig. 114 showing the derivative from these two.

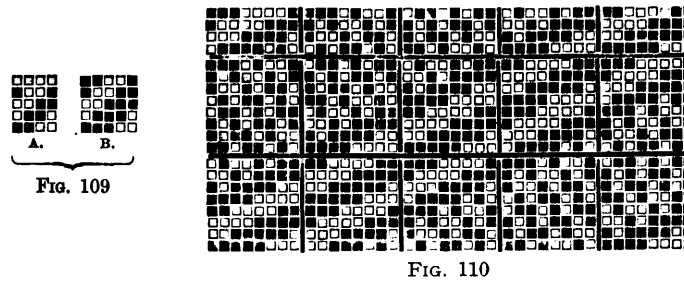

Our eighth method is that of rearranging a given base pattern in satin order. To show this let Fig. 115 be the base pattern, and Fig. 116 an eight satin, indicating the order in which Fig. 115 has to be rearranged. Our method of arrangement (Fig. 116) says that we must take the 1, 4, 7, 2, 5, 8, 3, 6 threads of our base pattern (Fig. 115) consecutively in order to produce Fig. 117, which is Fig. 115 rearranged in eight-end satin order. Figs. 118 to 121 are small examples of this system of working. These are the principal

methods employed for the production of fancy twills, and from their importance and use in general fabric structure may be called primary methods.

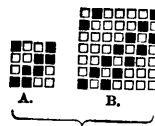

FIG. 111

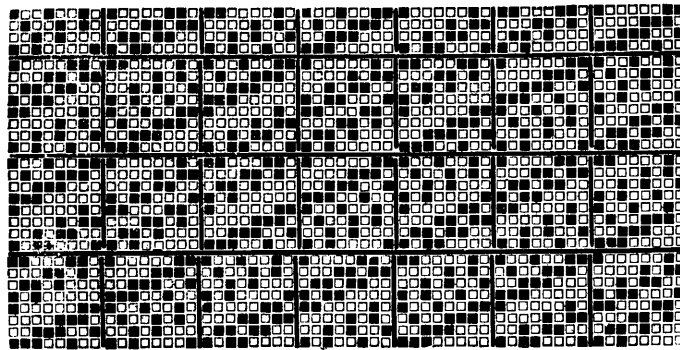

FIG. 112

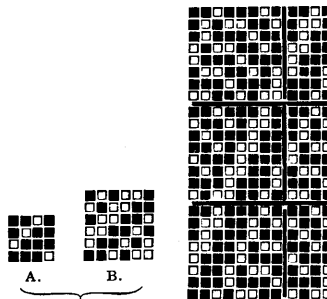

FIG. 113

FIG. 114

But there are other methods which produce effects peculiar to themselves, such as,

Broken Twills.—These are derived from the regular twills by running one-half of the base pattern in one direction, and the other half in the opposite direction, as shown by Figs. 122 and 123, thus breaking the diagonal line of the twill; hence the name “broken.”

Skip Twills.—The system by which twills of this class are made is really one of drafting. Fig. 124 is a base pattern of which Fig. 125 is the draft or drawing-in plan. By rearranging this draft, taking three, and missing two, eight times over, a new draft is

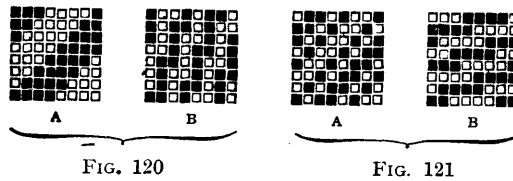
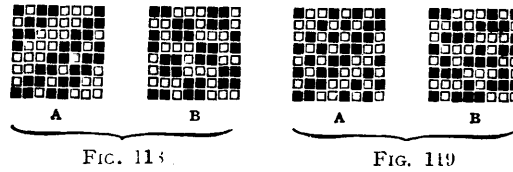
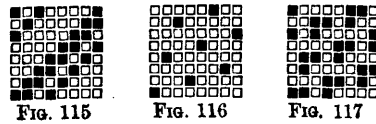

produced, complete on twenty-four ends (Fig. 126), and if we add the rising marks of the base pattern to the dots representing this new draft, we get the new pattern, Fig. 127. Figs. 128 to 131 give

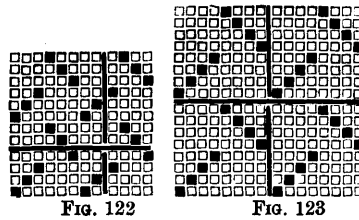

another example of this method of working. Fig. 128 is the base pattern, Fig. 129 the draft; Fig. 130 is made from Fig. 129 by taking four and missing three eight times over; and by adding the rising marks of the base pattern to this we get Fig. 131.

The rule for finding the number of ends required to complete a pattern by this arrangement is:—

The number of ends in the draft of the base pattern, multiplied by the number taken consecutively in the new draft, equals the number of ends in the new draft and pattern.

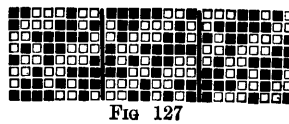
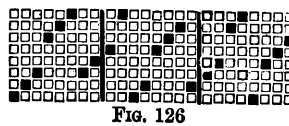

Corkscrew Twills.—Two of the simplest ways of constructing corkscrew twills are (1) by combining end and end two twill patterns of an equal repeat, and whose warp threads make the same number of intersections; and (2) by combining end and end twill patterns of an equal repeat whose warp threads make the same number of intersections, but having different lengths of floats.

(1) Figs. 132 and 133 are two seven-end twills, each having a float of four up and three down. By taking these and combining them end and end, and so arranging the two that the rising marks of one shall lock the sinking marks of the other, we have Fig. 134—a corkscrew arrangement giving equal-sized twill lines upon the face of the cloth.

(2) Figs. 135 and 136 are two eight-end twills, one being a five up and three down, the other being a three up and five down twill. Arranging these similarly to our last, we have Fig. 137; but in this case a twill is produced on the face of the cloth having alternately different sized ribs of pattern,

But these are not the only methods of producing corkscrew effects. We may apply to them either the first or second methods of fancy twill making, and so produce, A a reversed direction of pattern, and B a pattern having varying lengths of reversed

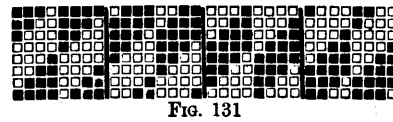
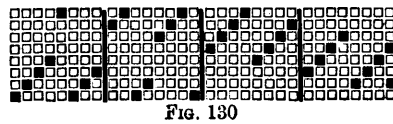
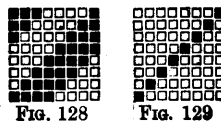

parts. As an example of the first of these, take Figs. 138 and 139 as the base patterns used for producing Fig. 140. By using this as a

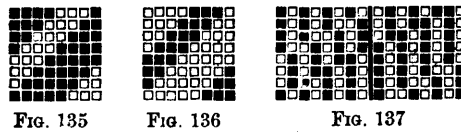
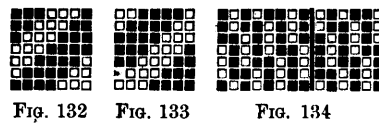

base pattern and reversing it in direction we have Fig. 141. For the second, take Figs. 142 and 143 as the base patterns. If these are combined in the same manner as our last and then reversed, so as to produce a short and a long point, we have Fig. 144.

Another method of producing corkscrew effects is by taking two twills having an equal number of ends in their repeats, but which have different lengths of warp floats, as in Figs. 145 and 146. Both these are eight-end twills, one having a float of four, the other of

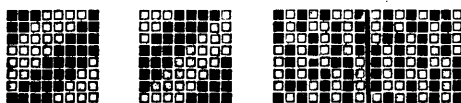

FIG. 138 FIG. 139 FIG. 140

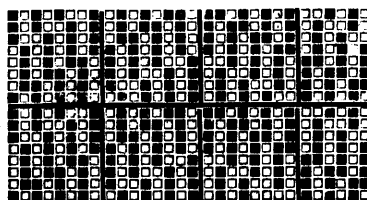

FIG. 141

two. Combining these in the manner already shown, we have Fig. 147, which presents a new feature to us, not found in the previous

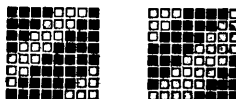

FIG. 142 FIG. 143

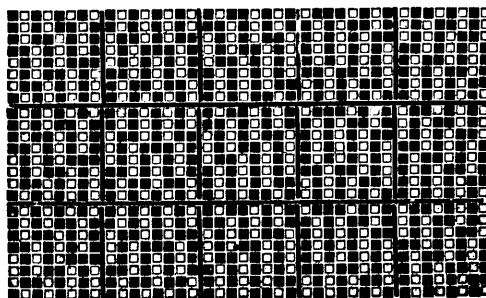

FIG. 144

examples. There the faces of the cloths were entirely made up of warp figure, but here the weft enters into and forms part of the face cloth. In making patterns of this class, care must be taken in

arranging the patterns. The weft floats must be equal and regular on one side of the warp rib.

There are several other corkscrew effects, such as curved, spot, and small diapers, which may be produced by methods similar to those already shown.

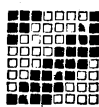

FIG. 145.

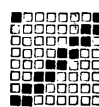

FIG. 146.

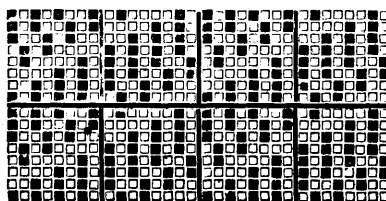

FIG. 147

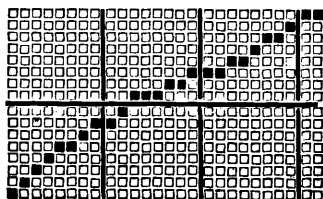

FIG. 148

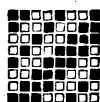

FIG. 149

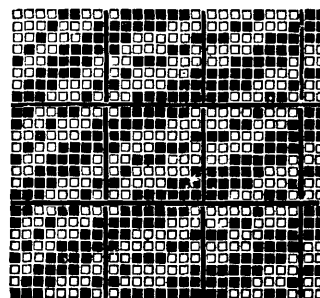

FIG. 150

Curved Twills—Are produced by giving to a twill varying degrees of angularity, which is a very simple matter worked by the following method. Fig. 148 is the curve we wish to produce in our new cloth, and Fig. 149 the base pattern which indicates the weave to be employed. Then by adding the rising marks of the base weave to those of the desired curve we have the curved twill Fig. 150—a pattern complete on twenty-six ends and eight picks. In like manner almost any regular

fancy twill may be used as a motive for a new pattern. Figs. 151-3 illustrate another example of the same kind of working—a pattern complete on fifty ends and twelve picks.

We have now fairly gone over the methods employed in fancy twill making, with the object of placing before students a systematic

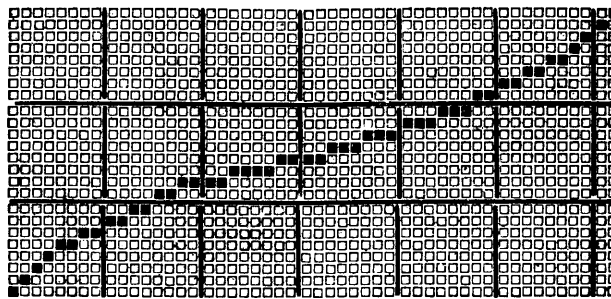

FIG. 151

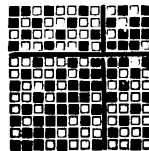

FIG. 152

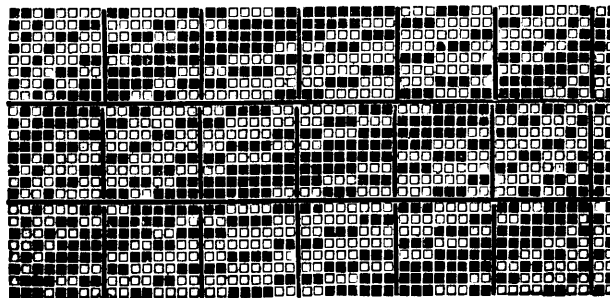

Fig. 153

course of pattern development as a basis for further work. We have yet to deal with the question of the structural perfection of our cloth, when compared with some given standard; for we cannot alter pattern without either altering the number of threads placed in a

given space, or else their diameters, if we wish to preserve the "balance" of our cloth. We may infer from the definition given in Chap. V. of what constitutes a plain cloth, that such a cloth is made up of equal thread and space. So that it follows, if any alteration is made in the number of intersections, such as is made in changing from one pattern to another, a corresponding change must be made in the number of threads employed. Let Fig. 154 be



FIG. 154

a section showing six ends intersected by a pick of weft. We have six ends and six intersections, consequently twelve units of space. But suppose these six ends are changed to a pattern having Fig. 155 for its section. We have now six ends and four intersections—



FIG. 155

only ten units of space. So that it follows we must either increase the diameter of the yarn employed or else the number of ends, if this is to be equally perfect with the plain cloth. Since, then, our cloth-building is a question of space and diameter, we have—To find the number of ends required for a given pattern, counts being known:—

Rule.—As the units of space in required cloth are to the number of ends in the pattern, so are the diameters per inch of the yarn to be used, to the number of ends per inch required.

In illustration of this let us take the cloths represented by the given sections Figs. 154 and 155, both to be made with 30's cotton warp or weft.

For our first we shall have

	Units o space.	Ends in pattern.	Diameters per inch of 30's cotton.	
I.—As	4	: 2	: :	143 : ends per inch
Therefore	4	: 2	: :	143 : 71.5.

	Units of space.	Ends in pattern.	Diameters per inch of 30's cotton.	
II.—As	10	6	143	: ends per inch.
Therefore	10	6	143	: 85·8.

This means that if we require 71·5 ends of 30's yarn to make the plain cloth, we shall need 85·8 ends per inch of the same yarn to make the twill equal in "balance" to the plain cloth.

This may be worked another way. Taking from a plain cloth a number of ends equal to the number in one repeat of the pattern of the twill, we shall have six ends and six intersections—therefore twelve units of space; in our twill, six ends and four intersections—ten units of space. Then

Rule.—As the units of space in one repeat of the pattern of required cloth are to the units of space in an equal number of ends in given cloth, so are the ends per inch of given cloth to ends per inch of required cloth.

In the required cloth we have ten, in our given cloth twelve, units of space. So that

As 10 : 12 :: 71·5 : ends per inch in required cloth.
Therefore as 10 : 12 :: 71·5 : 85·8 ends per inch, using
the same counts of yarn in both cases.

But this is only a part of the question, for we cannot always use the same counts of yarn even in plain cloth, much less so in changing from one pattern to another. We have seen why this is so in Chapter V., to which we have already referred. Suppose we say that our plain cloth is made with 40's yarn, what counts of yarn shall we have to use for the twill so that it may be equally perfect? Since this is simply a question of relative diameters to fill a given space, we have— To find the counts of yarn in changing from one pattern to another :—

Rule.—As the units of space in given cloth are to the units of space in required cloth, so is the square root of given counts to the square root of required counts.

In Fig. 154 we have twelve, in Fig. 155 ten, units of space. Then by Rule we have—

As 12 : 10 :: $\sqrt{40}$: \sqrt{x} .
Therefore 12 : 10 :: 6·3245 : 5·27
And since 5·27 is a square root, then $5·27^2 = 27·77$ —the counts to be employed in our six-end twill, of which Fig. 155 is a section.

CHAPTER VII

DRAFTS AND TIE-UPS

IF we were to state the principle which underlies all drafting in as few words as possible, we should say that all threads which lift alike in any given pattern may be drawn through the same stave of healds—an economy in the use of healds which enables us by very simple means to produce a somewhat complicated pattern, which would otherwise probably be beyond the scope of the shedding motion employed. This may be carried so far that it is quite possible to have several patterns running concurrently the length of the piece, all produced from the same set of healds; or one repeat of some given pattern stretching the whole width of the cloth.

“Drafting” or “drawing-in” is simply entering the warp threads in a set of healds; a “draft,” the order in which the threads are to be drawn through the healds; the order of drawing-in the threads giving its name to the draft, such as straight, centred, skip, mixed, or compound.

A draft may be expressed by one or two methods—either upon design paper, or by making a plan of a set of healds with the threads drawn through them, indicating by a mark through which heald any given thread is drawn.

Let A, Fig. 156, be a design taken from a piece of cloth, and the horizontal spaces of B a set of healds. Upon examining the pattern we find threads 1, 9, 17, and 25 all working alike—that is, they are lifted or depressed over and under the same picks of weft at the same time. Then draw these threads in the first stave of healds, and indicate this by marking them in the first horizontal space. Proceeding in this manner with the other threads

of the design, our completed draft shows that the pattern is complete on eight ends, and that eight staves of healds are required to produce it. This is an example of a straight draft—straight, because consecutive threads are drawn on consecutive staves of healds. In like manner with c, in the same Fig., the horizontal lines represent staves of healds, the vertical ones warp threads; so that by placing marks on the intersections of these two sets of lines we have shown exactly what is in B. It will be noticed that we require a staff of healds for every thread of the pattern, so that with a straight draft no economy can be exercised in the number of heald staves employed for the production of a pattern.

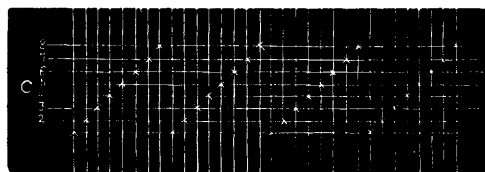
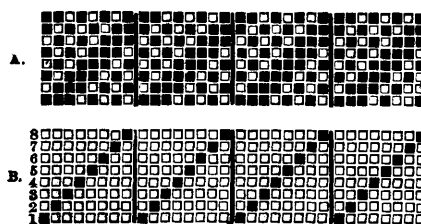

Fig. 156

At Fig. 157 we have a pattern to illustrate a centred or point draft—a pattern where one half is like the other; and since all threads which work alike in a pattern can be drawn on the same staff of healds, we only require 17 for this pattern of 32 ends. This must be so, since there are two staves—the first and seventeenth—which have only one thread drawn through them, while all the other staves have two threads per pattern. Taking this to be a pattern centred on seventeen ends, we have $17 \times 2 - 2 = 32$ ends required for a complete repeat of the pattern and draft.

But there is another form of centred draft, which might be called a double-centred draft, illustrated by Fig. 158.

Here we have a pattern (A) on 32 ends requiring, as shown by the draft, B, 17 staves of healds. But such a draft as this is a very awkward one for the weaver, particularly if by any accident a quantity of yarn is broken out. If the pattern were arranged similarly to that at Fig. 157, it might be made, as that figure is, by a simple centred draft, and so the drawing-in of the yarn would be a comparatively easy matter.

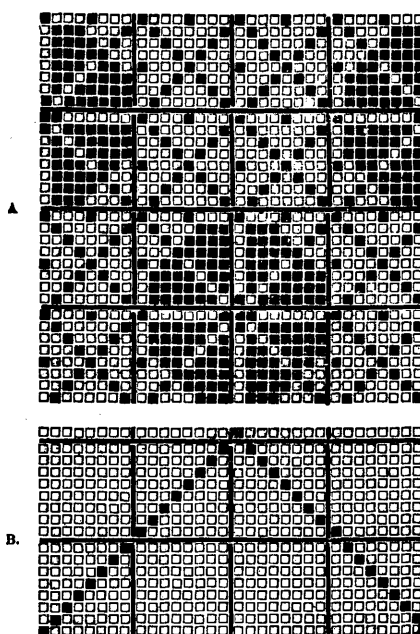

FIG. 157

The Skip-Shaft Draft is one that is mostly used for plain cloth weaving when four staves of healds are used for that purpose, which is only a matter of convenience to prevent the overcrowding of the healds that would probably take place if only two were used when weaving close sett fabrics. This is shown at Fig. 159, where A is the pattern, B the draft, C the skip-shaft arrangement where the two front staves would be tied together so as to work as one, the two back ones being tied similarly.

To illustrate mixed drafting let us take Fig. 160, a design for a satin striped cloth, the stripes of which may be made of any desired width. It will be noticed that the pattern extends to 64 ends, but that only 10 staves of healds are required, as shown by the draft, which is made up of plain cloth on two and a straight draft on eight staves of healds.

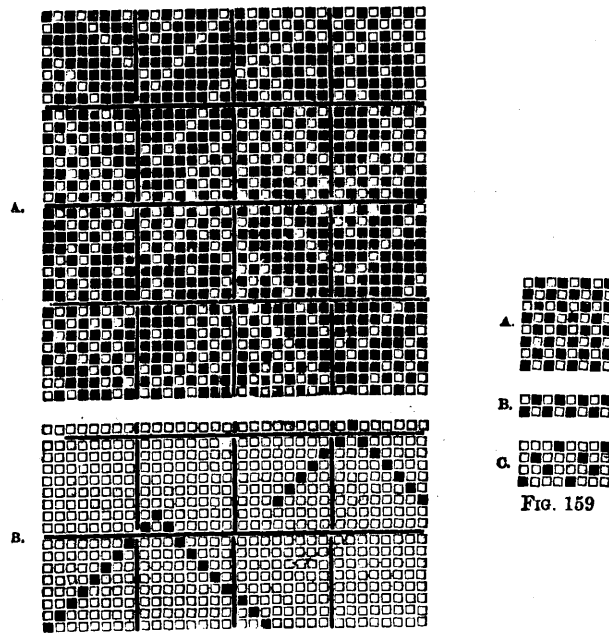

FIG. 158

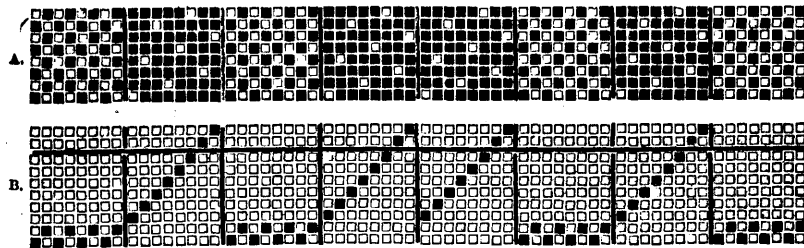

FIG. 160

Fig. 161 is another example of a striped cloth, the design being made up of two twilled effects complete on 32 ends and 8 picks, the whole needing but eight staves of healds.

The saving of two staves of healds, as shown in the draft for Fig. 162, a design made up of two six-end twills, produces a draft which is perhaps not altogether an economy as far as the weaver is concerned, as it would be much simpler to use twelve staves of healds with the draft shown at c in the same figure. Such an example as this will show that it is not always desirable to reduce, by drafting, a pattern to the lowest possible number of heald staves.

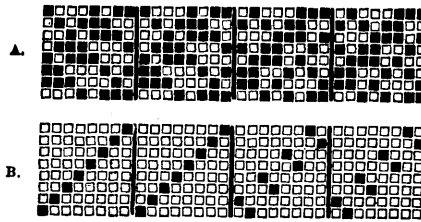

Fig. 161

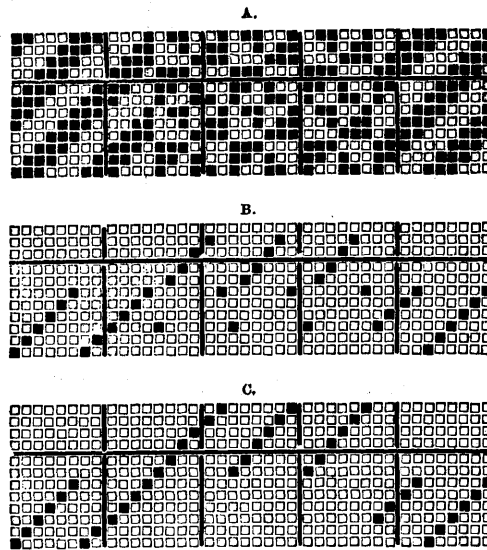

Fig. 162

In Compound Drafting we have the principle of drafting employed for the production of large and extended patterns, Fig. 163 being perhaps the simplest example of this class of pattern we can instance. It will be noticed that the design is reversed in direction

both in warp and weft, the whole being based upon a four-end twill while the effect produced is that of pattern within pattern; and it will be easily conceived that by the application of this method of drafting a single repeat of a pattern may be made to occupy the whole width of a piece of cloth.

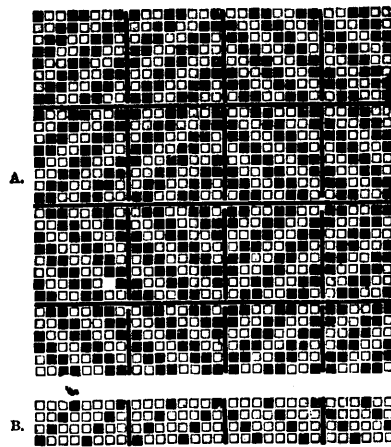

FIG. 163

As a draft is the order of drawing the warp threads through the healds, so is a "tie-up" the order of lifting or actuating those healds so as to produce a given pattern. Instead of the word "tie-up" we have such terms used as "treading-plan," "pegging-plan," and "card-cutting plan;" but they simply indicate what kind of shedding apparatus is to be used for actuating the healds.

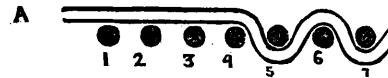

FIG. 164

The principle which is the basis upon which all "tie-ups" are made is this—that a stave of healds through which a given thread is drawn must be lifted and depressed according to the intersections such a thread makes in the pattern. This will be instanced by Fig. 164, where A is a warp thread intersecting with picks of weft

1, 2, 3, 4, 5, 6, 7, and it will be evident that the heald stave through which this thread is drawn must be actuated so as to produce these intersections.

Perhaps the simplest of all ways for recording a tie-up is that employed for handloom work. A, Fig. 165, is a pattern the draft of which is produced at B. This shows that 8 staves of healds are required, the draft being a straight one. At C the horizontal lines represent heald staves, the vertical ones treadles, numbered 1, 3, 5, 7, 2, 4, 6, 8—an arrangement that enables the weaver to use both feet without any crossing or recrossing. Looking along the first pick of the pattern we see that threads 1, 2, 4, 6 are to be lifted, and as these are drafted on heald staves 1, 2, 4, 6, then these staves must be lifted for this pick. This is indicated by

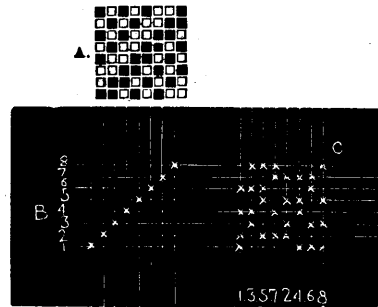

FIG. 165

placing marks on the intersections made by the crossing of the first vertical with the horizontal lines, and so for the remaining picks of the pattern, as shown at C.

But this is only one phase of handloom tying-up—the practice which obtains where negative shedding is employed. Here the heald is lifted by the treadle from the level of the race board, but in tying-up for positive shedding not only must the rising of the healds be marked, but the sinking as well. This is shown at Fig. 166, where A is the pattern, B the draft, and C the tie-up, showing two kinds of marking. If we read along the first pick of the pattern we see that we have warp threads 1, 2, 4, 5, 7 to lift, but that threads 3, 6, 8 have to be pulled down. This is indicated on No. 1 treadle,

the crosses being the rising, the dots the sinking marks. Of course the tie-up of Fig. 165 may be used for positive tying-up if we read the blanks as sinking marks.

There is only a slight modification of this working when tie-ups are made out on point paper, to illustrate which let A, Fig. 167 be a pattern, and B the draft. By reading the vertical spaces of the design

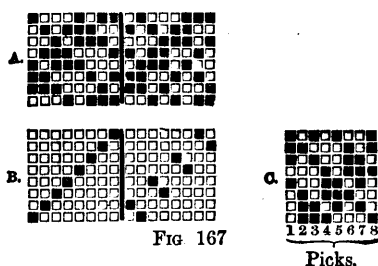

FIG 167

A as picks, and placing opposite to the heald stave the action of the thread that is drawn through it, the tie-up C is produced. For convenience sake it may be made out so as to read down the paper, the topmost horizontal space representing the first pick, as Fig. 168,

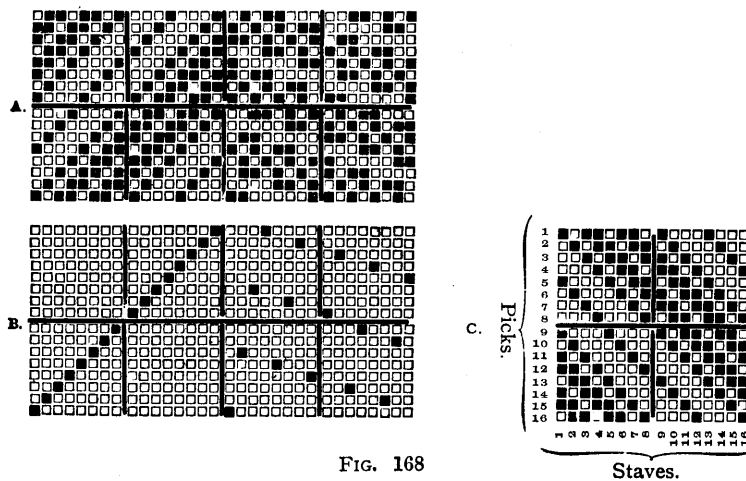

FIG. 168

where A is the pattern, B the draft, and C the tie-up. Since the second half of the pattern is but a satin arrangement of the first, the whole is drafted on 16 staves of healds, the tie-up being, as shown at C, on 16 picks.

It will be seen from the examples given that wherever we have a straight draft the pattern can always be used as the tie-up, because every individual thread of the pattern must be drafted through a separate stave of healds.

To illustrate a tie-up for a centred draft, let A, Fig. 169, be the pattern, B the draft. Since one half of the pattern is like the other,

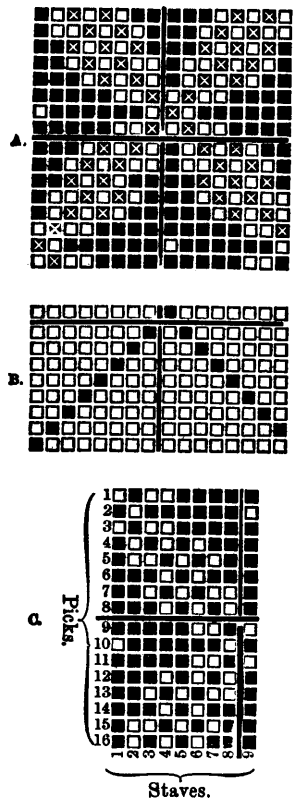

FIG. 169

then half the pattern becomes the tie-up, as shown at c in the same figure.

Let us now give one example of how pattern may be produced from a given draft and tie-up. At A, Fig. 170, we have a mixed draft on 8 staves of healds, and suppose B in the same figure to be

the tie-up we wish to use—which shows that each heald stave has to be held up for four picks and down for four—then by taking the rising marks of the tie-up in the order shown by the draft, the

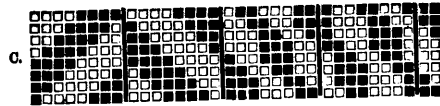
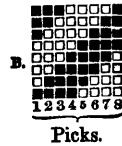
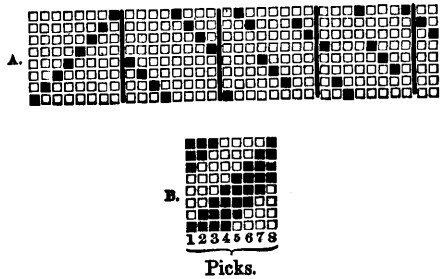

FIG. 170

fancy twill shown at c will be produced. By altering the draft in the manner indicated, an almost infinite variety of fancy patterns may be made on a comparatively small number of heald staves.

CHAPTER VIII

ARRANGEMENT OF TWILLED AND SATIN PATTERNS

In arranging twilled and satin patterns so as to produce diaper effects a good deal of labour is involved, which arises from the fact that the figures used for this class of fabrics are large, and must necessarily cover a large number of ends and picks when put upon point paper. By "diaper effects" we do not mean what is generally meant by that expression—any small figured effect that may be used for the ornamentation of a cloth—but we mean those parallelogrammatic figures used in such fabrics as tablecloths, etc., a figuring that is the result of structural design. All this class of pattern is a product of reversing the order of interlacing of warp and weft threads as shown at Figs. 94, 95, and 96, whereby we have perfectly reversible cloths as far as the design goes. By

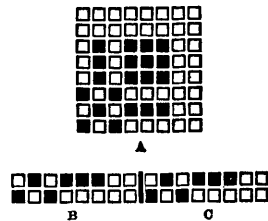

FIG. 171

arranging these patterns and their drafts and tie-ups in a condensed form, the whole thing becomes a very simple matter, because we have by a few squares on design paper a method of expressing all we want, instead of working out the design to its full extent, simply indicating what takes place instead of actually putting down a transcription of our cloth.

The method employed for this purpose is illustrated by the following:—Let A, Fig. 171, be a condensed pattern, having all the

characteristics of the ornament which we wish to use for our fabric. If we understand that each one of the rising and sinking marks of this may represent any given number of ends and picks, say

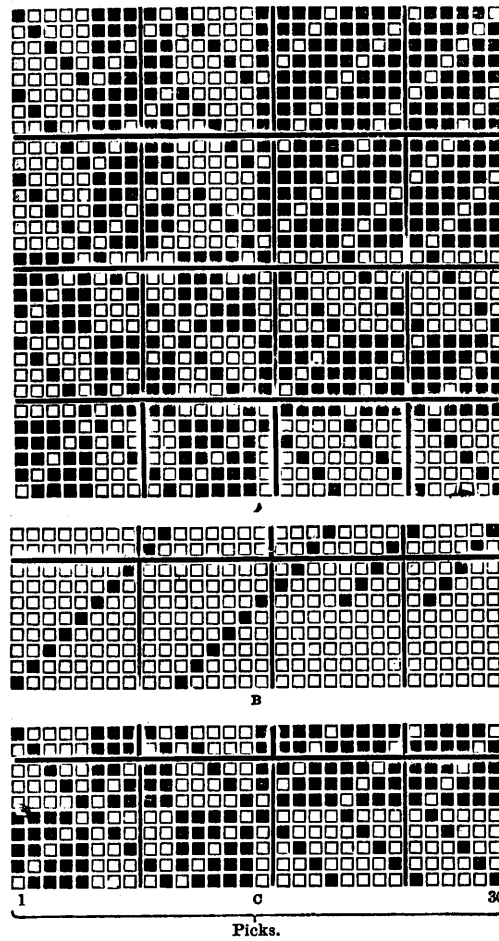

FIG. 172

five, then it becomes a condensed expression of Fig. 172, which now occupies thirty ends and picks. As these patterns are either reversed twills or satins, we proceed to put on the binding

points—in this case in five-end twill order—and arrange them so that the binding of the weft shall lock the binding of the warp, and our pattern is complete.

In Fig. 171 we see that the draft B indicates two staves, but since each vertical space stands for five ends, and each horizontal space for five staves, it is but the condensed form of B, Fig. 172, which shows the draft carried out to its fullest extent. And so by c, Fig. 171, which is the condensed tie-up for that figure, since each one of its picks represents five, we have, when carried out to its fullest extent, c, Fig. 172, which is the tie up of that figure.

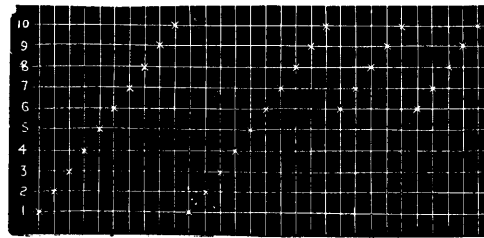

FIG. 173

The advantage of this method of dealing with patterns of this class is the time saved in designing them, as well as the ease with

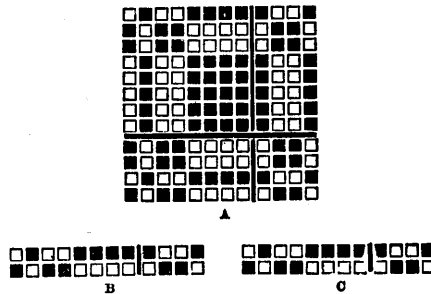

FIG. 174

which drafts may be made out for drawing-in purposes. So long as one dot of the draft is understood to mean a complete draft on that set of healds, we should read B, Fig. 171, as—once over on the front, once over on the back, once over on the front, three times

over on the back, which is quite as simple as the full draft shown at B, Fig. 172. Yet either of these is simpler than that shown at

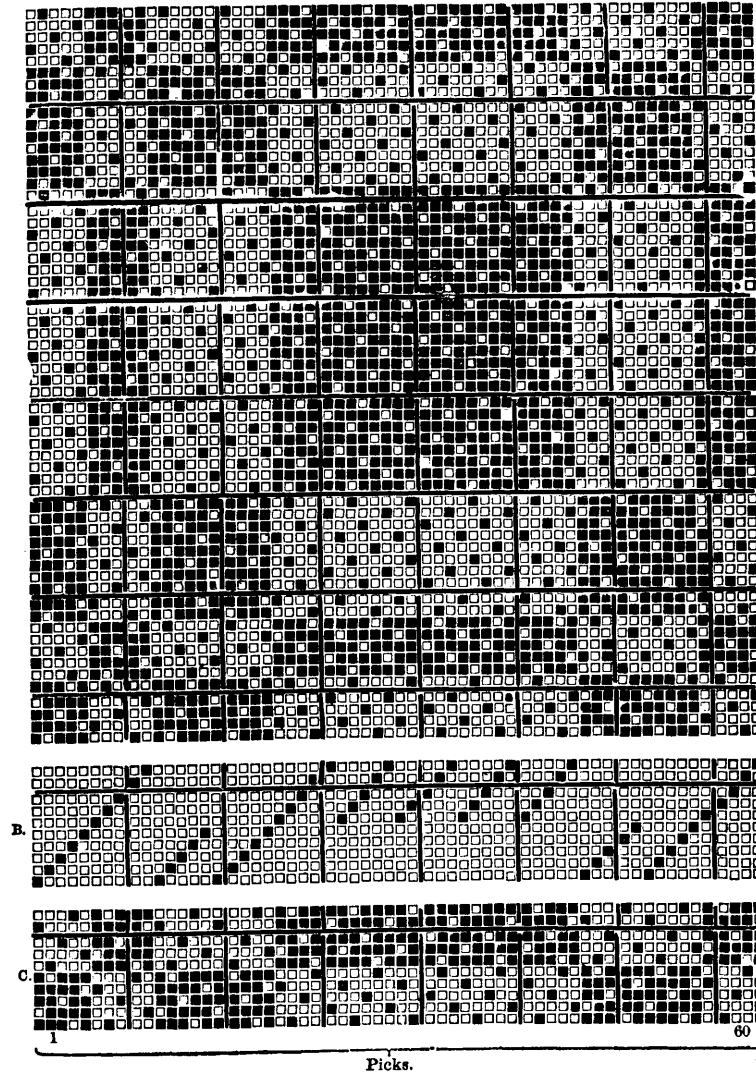

Fig. 175

Fig 173, where the horizontal lines represent staves of healds, the vertical lines warp threads, the marks indicating upon what stove

of healds a thread is drawn. This is a method very commonly pursued in spite of the labour entailed.

We have already intimated that these fabrics may be either twill, as in the example given, or satin. To illustrate this latter, let A, Fig. 174, be a pattern to be developed as a five-end satin; B is the draft, C the tie-up, the condensed form occupying twelve spaces each way. Since each space stands for five, our fully developed pattern, A, Fig. 175, occupies sixty ends and sixty picks, the draft B ten staves of healds and sixty ends, whilst the tie-up C shows the action of the healds for the whole of the sixty picks.

From these examples it will be seen what an economy may be practised in designing for these fabrics.

But this will be more apparent in dealing with bordered goods, to produce which three and four sets of healds are often necessary. One example of this character will suffice to show the advantage of this condensed method of designing.

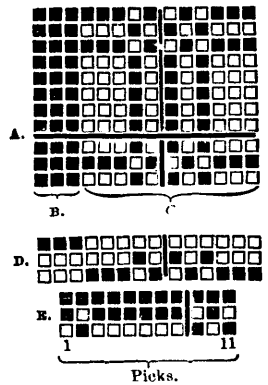

FIG. 176

Let A, Fig. 176, be a suggestion for a bordered fabric; the portion B represents the border, which may be made of any desired width; C one repeat of the middle; while D and E are respectively the draft and tie-up for same. Developing this, and using a five-end satin weave for the build of our cloth, we have Fig. 177, where A is the pattern; B the draft, and C the tie-up.

ARRANGEMENT OF TWILLED AND SATIN PATTERNS 73

Such, then, is the method employed when dealing with patterns of this class, most of which are got up in the five-end satin weave,

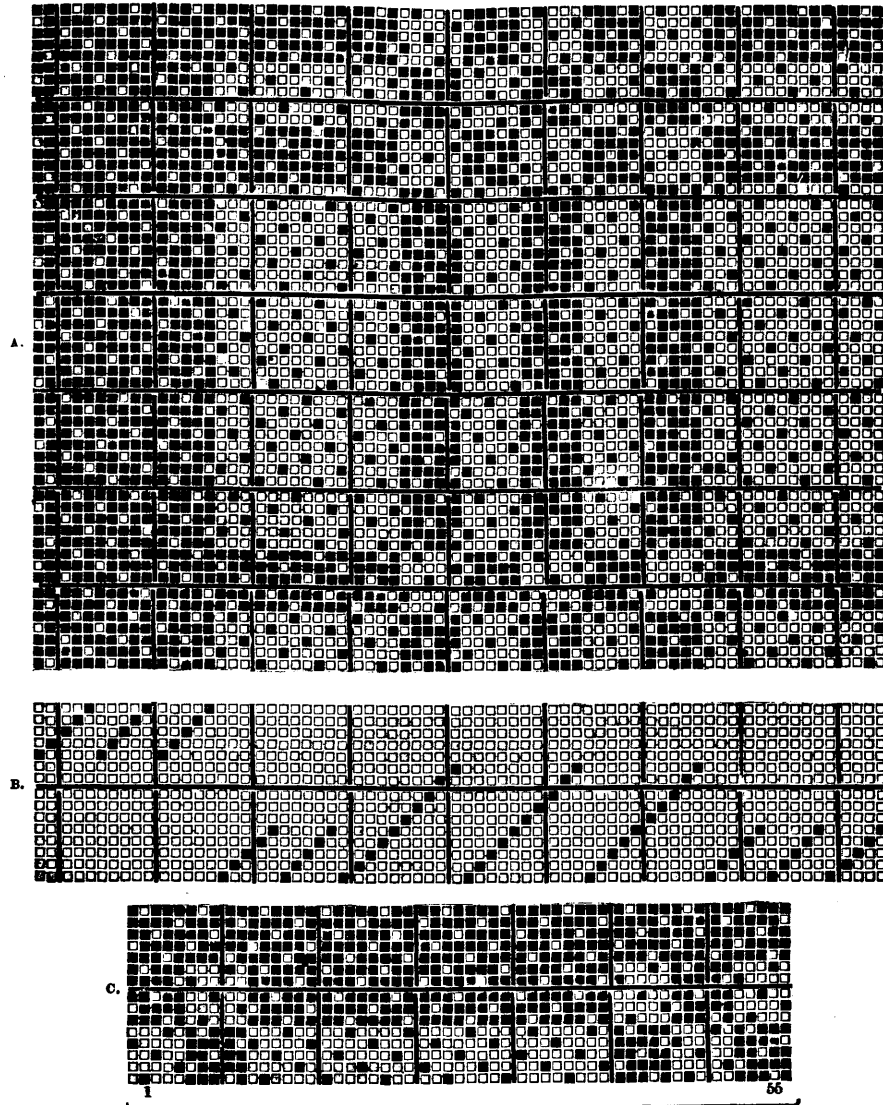
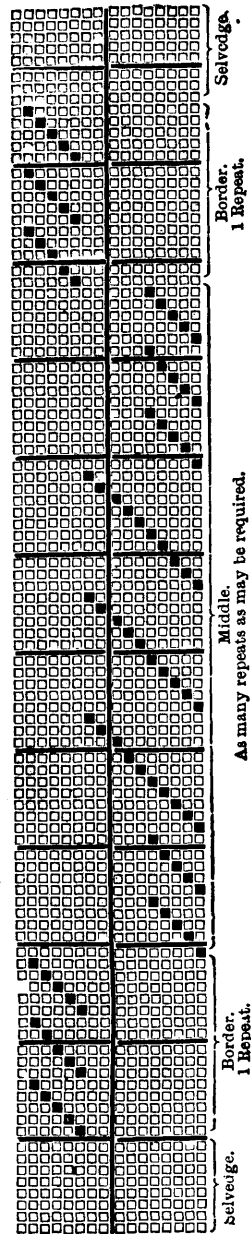

FIG. 177



though the seven and eight-end satins or twills may be used for this purpose, arranged of course so that all the intersecting points are "locked." Another consideration of importance is, that the drafting of the pattern must be so arranged that the portions coming next to the selvages or borders will be alike at the sides of the cloth, as instanced in our last figure, which is arranged so as to begin and finish with a half-pattern next to the side borders. The healds used are spaced to the requirements of the pattern, and must be knitted to the draft employed, instructions for which may be got out similarly to the method shown at Fig. 58. Fig. 178 will be sufficient to show how the drafting instructions may be made out for the "drawer-in" if the full draft of the pattern is preferred to the condensed one.

CHAPTER IX

SPOTTING

This division of figure weaving has for its object the ornamentation of a fabric by planting detached figures on its surface; recurring figures placed at regular intervals so as to comply with a geometrical distribution of pattern. These spots may be either in the cloth or upon the cloth, in the cloth when only one warp and one weft are used for the purpose; on the cloth when such spots are produced by using extra materials, weft or warp.

But the first consideration in dealing with this kind of weaving, must be the distribution of a given figure motive over the space placed at our disposal by the figuring capacity of our machines. If we are to have a balance of pattern, we must have a basis of distribution, and place the ornament in regularly recurring spaces. This holds good whatever the character of the figuring may be, from the simplest diaper to the most intricate form of jacquard spot patterns.

First, then, our pattern may be arranged on a plain-cloth basis, which simply means that some figure motive is to be arranged on a given space, so that it will have the same relative positions on a given number of ends and picks that the dots occupy in our basis. Let *a*, Fig. 179, be the basis of arrangement, *b* the figure motive for our new design, to be arranged on 24 ends and picks. Dividing these into as many equal parts as there are equal parts in the basis of arrangement—four—we have *c*, upon which we place as many repeats of our figure motive as we have dots in the basis. This is shown at *d*, by which we get an even distribution of pattern over a given number of ends and picks, the pattern bearing the same relation to these that the dots do in the basis of arrangement.

But our pattern may be arranged upon a twill basis by a similar method to our last. Let A, Fig. 180, a four-end twill, indicate the arrangement to be followed in disposing of B, the figure motive, over a given number of ends and picks—say forty. Dividing these into as many equal parts as we have parts in our basis, and placing the figure upon these divisions we have C—a spot arranged on 40 ends and picks in four-end twill order.

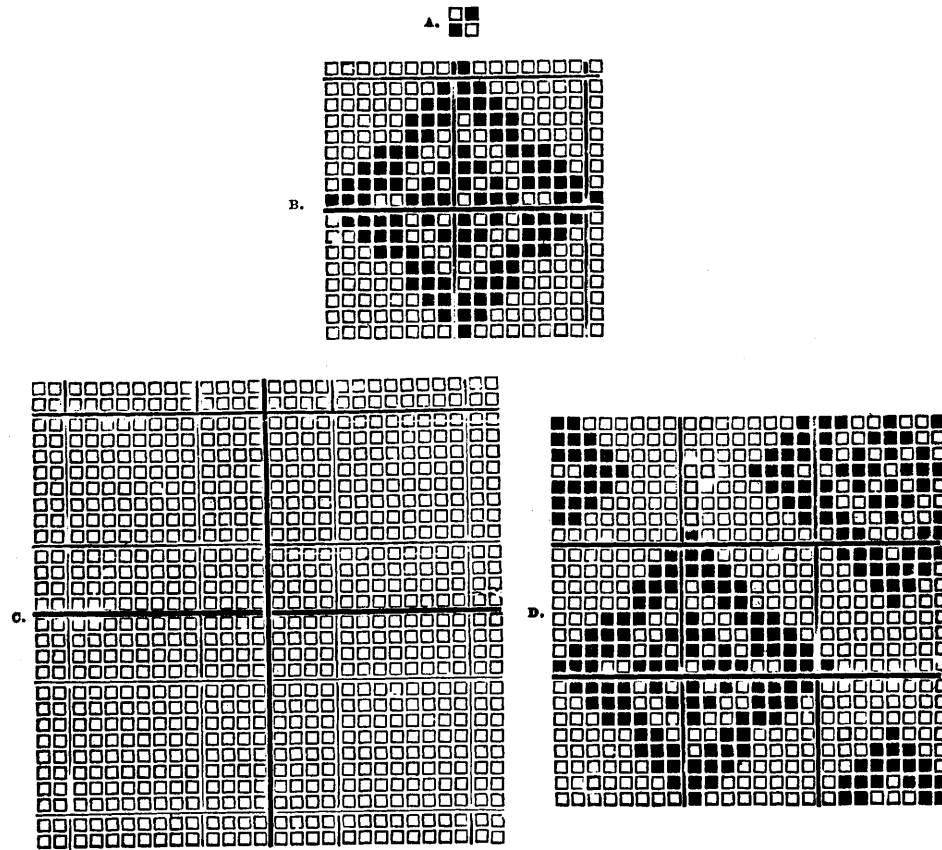

FIG 179

But it will be seen that this method of arrangement could only be followed for particular, not for general, purposes, because the

very basis of the distribution gives to our pattern a direction which is only applicable to special purposes—a diagonal rib of pattern

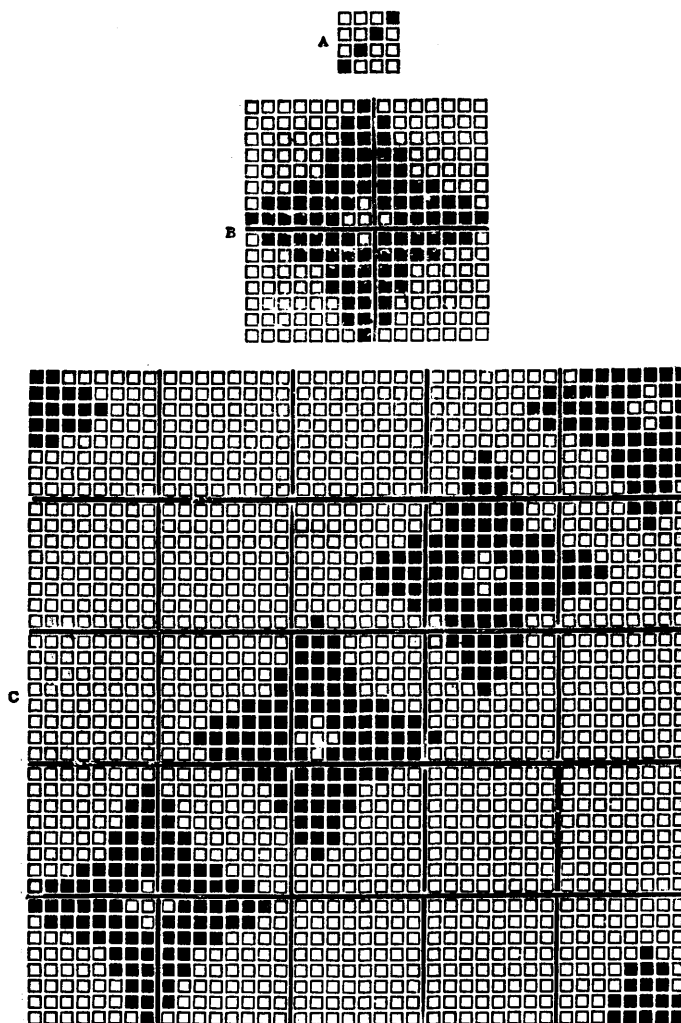

FIG. 180

running up and across the cloth is produced, which would be more apparent if several repeats of the pattern were worked out. But

any tendency to direction of pattern is greatly minimised, and more particularly so if the spots are placed at somewhat wide distances

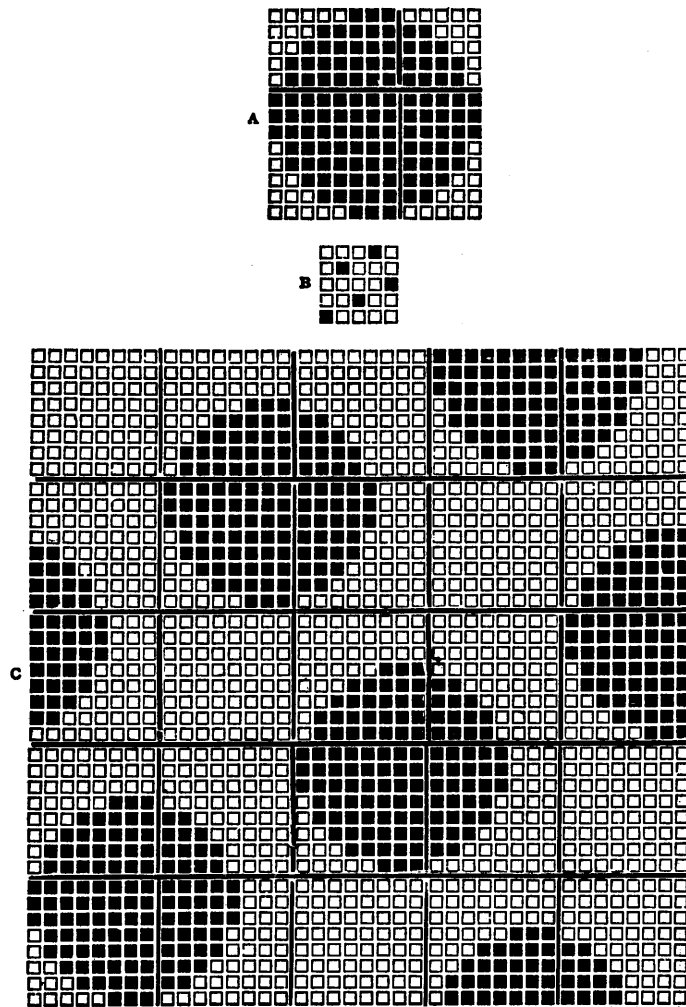

FIG. 181

apart, by employing some satin as the basis of arrangement of the figure. Let A, Fig. 181, be a figure motive which has to be

developed in five-end satin order on 40 ends and picks—B is the five-end satin. Dividing these into as many equal parts as we have parts in the basis, and placing the figure motive on the new squares in the order indicated by the satin dots, we have c.

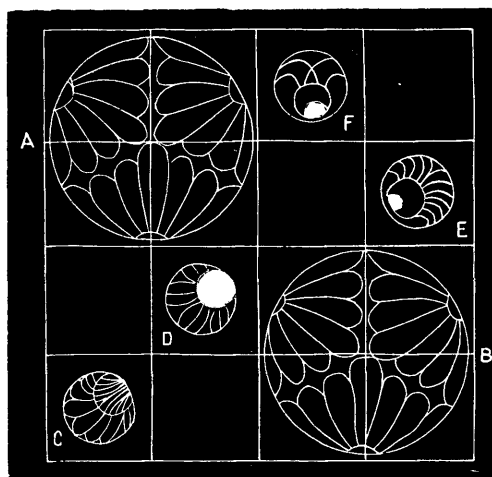

Fig. 182

Another method sometimes employed for the arrangement of pattern is one where we have some comparatively large figure motive to deal with, to which is added minor figures which are

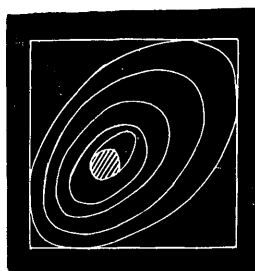

FIG. 183

used as secondary ornament to our first. Fig. 182 will illustrate this. Dividing the space placed at our disposal into four equal parts each way, the two spots A, B are placed in plain-cloth order in relation to each other, while the minor spots, c, D, E, F, are

arranged in four-end satin order—a mixture of our first and third methods of arrangement. There are, however, many forms which will not admit of being treated by any of the preceding methods, having in themselves a direction which would give a decided diagonal rib of pattern running up and across the cloth. Such a form as that shown at Fig. 183 would do this. But if this spot was arranged in plain-cloth order, with the second repeat of the figure placed so as to oppose the first, this line would be destroyed, as shown at Fig. 184.

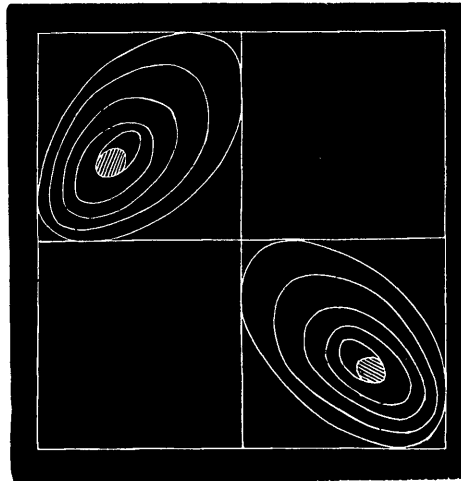

FIG. 184

The drafting and arrangement of healds for most spot work of small extent of figure has already been shown by such figures as 157 and 158, but the ground weaves need a few words of explanation. All warp figures ought to have weft grounds, and weft figures warp grounds; for it is only by the relief that one gives to the other that the figures are made prominent, and to stand out, as it were, from the face of the cloth. This might be instanced by Fig. 181, to which we could add a plain-cloth, a weft-satin, or a weft-twill ground, with the advantage that by doing so the binding points of the ground weave might be carried close to the edges of the figure without destroying its outline,

while a warp ground could not be carried close to it for this very reason. To give prominence to a warp figure on a warp ground, colour would have to be used, which is not always available for this purpose.

Having dealt with spotting where only one weft and one warp are employed, we are brought to that system of figuring known as Figuring with Extra Weft—a use of material which has for its object the production of figure that is on the cloth. The same

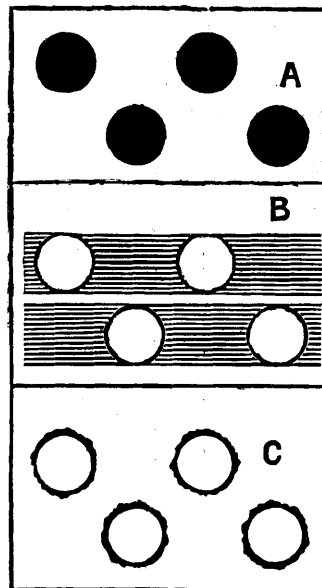

FIG. 185

methods obtain here as in our last as regards the distribution of pattern, but the way in which the patterns are put upon point paper is quite different, while the looms employed must of necessity be multiple box looms of some sort.

The structure of the fabrics produced by this system of weaving is that of a ground cloth ornamented by a second series of weft threads, which, after producing the desired figure upon the face of the cloth, are immediately thrown to the back as waste material, which may or may not be cut away during the finishing operations,

illustrated by Fig. 185, where A shows the face, B the back with the uncut weft passing from spot to spot, and C the back of the cloth with the waste weft cut away, leaving nothing but a little ragged edge on two sides of the figure.

First, then, let us take an example to show how these extra weft figures are put on point paper, the spot to be produced by using an extra shuttle. Let A, Fig. 186, be our figure motive,

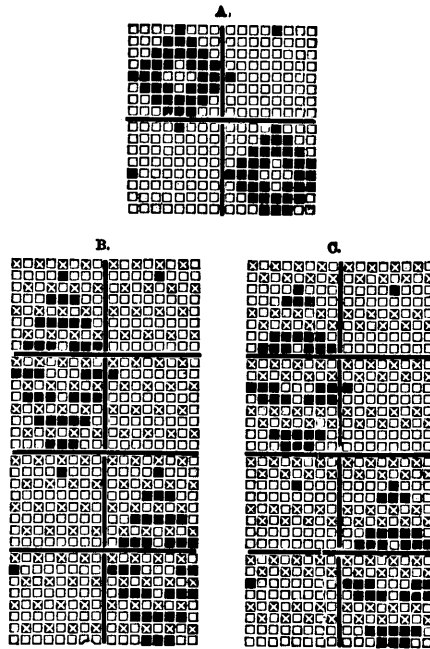
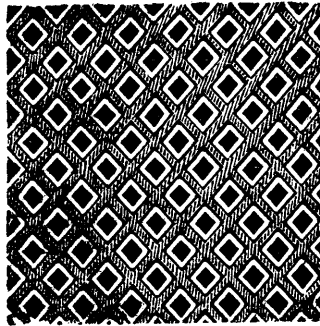

FIG. 186

be arranged in plain-cloth order on 16 ends and 32 picks, the ground plain cloth. As these figures are woven either pick and pick or else two ground two figure, we have at B our figure arranged for the first of these, and at C the arrangement for the second. Perhaps the easiest way of designing for all such goods as these is to arrange the figure motive similarly to that shown at A, and from this to cut the figuring cards. Having done so, then cut as many plain cards as are required, and lace the whole one ground one

figure, or two ground two figure, so as to meet the picking arrangements of the loom upon which the cloth has to be woven. This proceeding saves at least one-half the designing. It will be noticed, too, that the given figure is arranged so as to weave the pattern face downwards, which is advisable in many cases, as the lifting would otherwise be too heavy, especially where springs are used for keeping the warp down to the level of the race board.

A.



B.

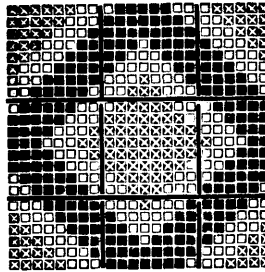

FIG. 187

Our second example of this kind of weaving, shown at A, Fig. 187, is where two colours are employed, each making its own portion of the figure and then passing, as in the previous case, to the back of the cloth. To save time in designing such fabrics as these, the figure motive may be arranged as shown at B, the several parts being painted up in the colours it is intended to use. Cutting the cards from this we should have—First cutting, cut ■, second

cutting, cut \boxtimes ; and, having the required number of plain cards, the whole would be laced together, two \blacksquare , two \boxtimes , two \square —a method which in this case has economised two-thirds of the designing, as will be seen by referring to Fig. 188, which is the full card-cutting plan for Fig. 187.

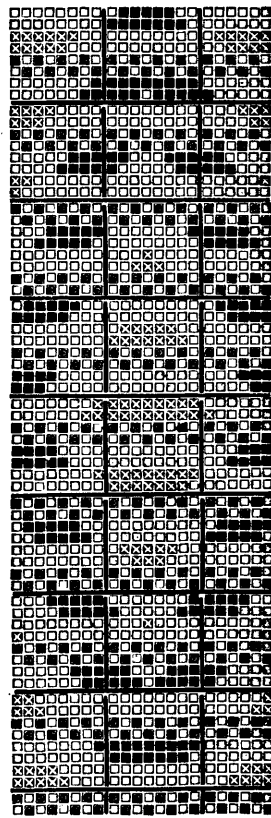

FIG. 188

In the foregoing examples it will be readily seen that no cutting away of the waste material floating from spot to spot could be done, as the spots are not bound to the ground cloth to prevent their being pulled off. It will also be seen that if we attempt to bind

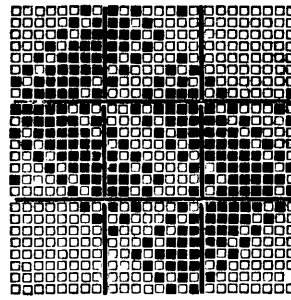

FIG. 189

this extra material to the ground cloth, the binding points cannot be hidden, owing to the character of the ground. To allow, then, this waste material to be cut away, as well as to secure the spot to the ground cloth, we may have recourse to (a) running lines round the edges of the figure, as Fig. 189; (b) changing the ground cloth from plain to twill or satin, by which we can bind the figuring picks into the ground without their showing on the face of the cloth, as in Fig. 190, where A is the figure motive and B the same arranged on a four-end twill ground; or (c) the figure itself may be got

up in a twill or satin weave, as Fig. 191, where A is the figure and B the same got up in a four-end twill weave on a plain ground.

Perhaps the most expressive form of spotting with extra weft is where two or more colours enter into and combine with each other

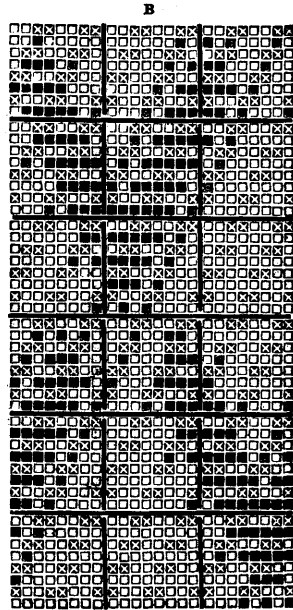
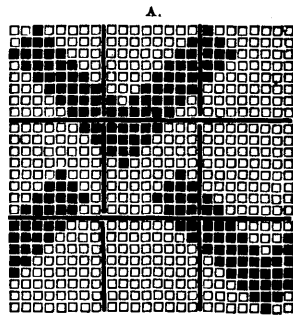

FIG. 190

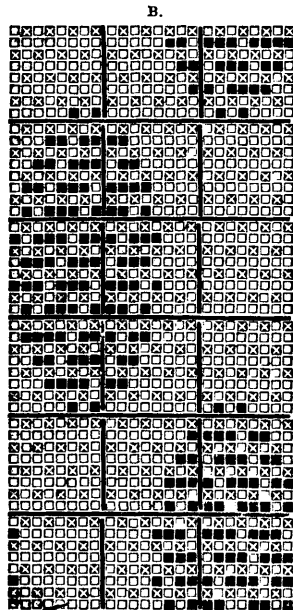
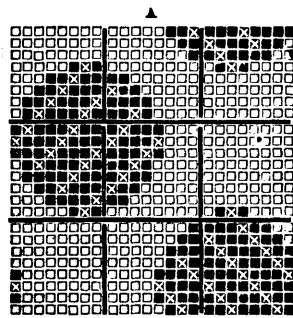

FIG. 191

to form a figure motive, the effective display of pattern being considerably heightened if the ground cloth is also woven with coloured yarns. Fig. 192 is an example of this kind of weaving,

the spot being black and white upon a plain ground cloth or a quiet neutral grey.

To show how such spots as these are put upon design paper, let Fig. 193 be our figure motive, to be woven in two colours, similar to Fig. 192. Having found the number of ends and picks occupied by one spot—from the count of reed to be used and the number

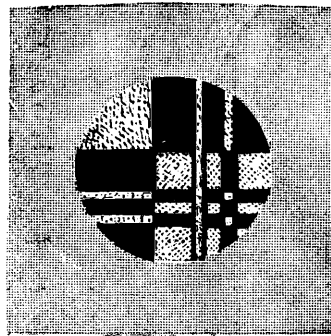

FIG. 192

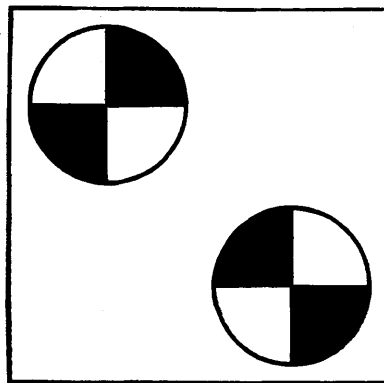
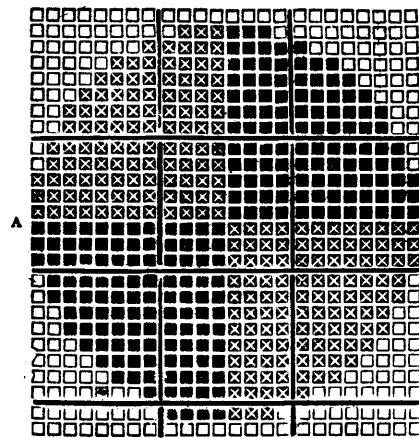

FIG. 193

of picks to be put in—let us suppose that a, Fig. 194, represents its size when put upon point paper, and that the solid black represents one colour, the crosses the other—one spot occupying 24 ends and picks. Proceeding to arrange this for a loom having three boxes at one side and one at the other, the full card-cutting plan b will

show 72 picks and 24 ends in the order of two ground, four figure. All such figures may be bound to the ground cloth by some satin or twill weave.

The yarns used for such cloths as these are very varied in character, those for the ground being of some medium or fine counts, while those for the figures are of coarse, soft



rovings, used for the purpose of producing a figure that spreads out and entirely hides the ground cloth upon which it is placed.

In swivel weaving we have an economical use of extra figuring weft, which is only put in according to the size and requirements of the pattern. With the exception of a single thread which is carried

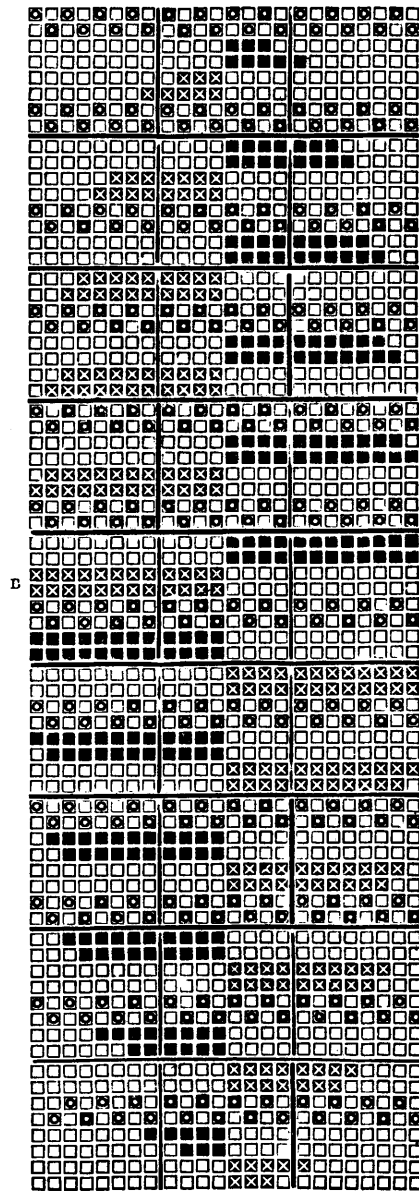

FIG. 194

along from spot to spot, we have no loosely floating material on the back of the cloth to be cut away or bound into the fabric, as the case may be. This, as well as the disposition of the spots, is shown by Fig. 195, which is simply a sketch to illustrate the relation of figuring weft to ground cloth, though the apparatus used for the purpose may also be employed for the production of a continuous figure effect, as shown by sketch, Fig. 196—a suggestion for an extra weft spot on a striped ground.

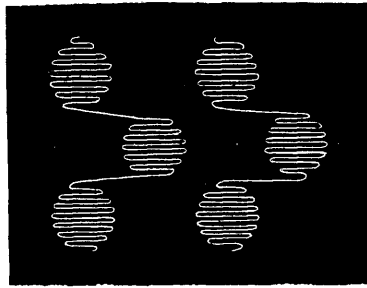

FIG. 195

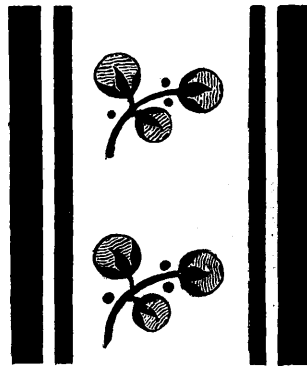

FIG. 196

The swivel "rack" is an arrangement of small shuttles attached to the front of the lay, and by the arrangement of parts may have a vertical and a horizontal movement given to it—vertical, when the shuttles are moved in or out of action; horizontal, when the shuttles are to be carried through the sheds made for the insertion of the figuring picks. The recessed parts of the "rack" allow the warp

threads to be lifted up after the manner shown at Fig. 197, where A is a "breast" of cloth with spots arranged in plain cloth order; B, the warp lifted for shuttles C, C, to pass beneath. Having completed this row of spots, the whole rack is moved along so as to be in a position for making the next row, corresponding to D. While spotting, the "rack" is lowered and raised on alternate picks, as the wefts are put in pick and pick, but is kept up all the time the ground between the several rows of spots is being woven.

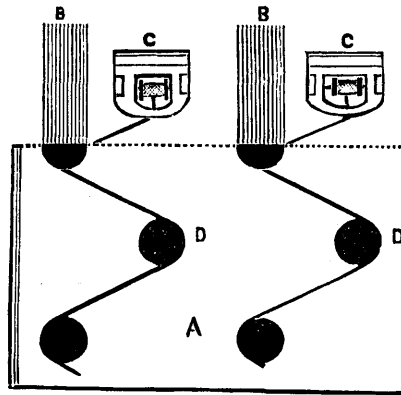
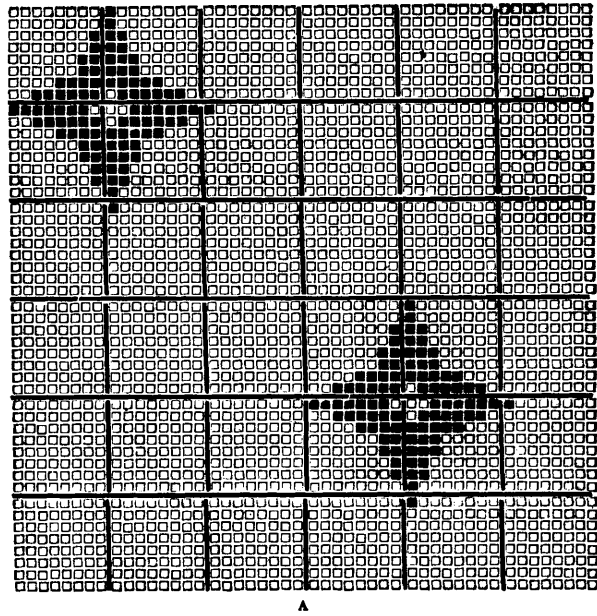

FIG. 197

Now it will be seen that the construction of fabrics by this method of weaving is identical with that produced by using extra shuttles; but while with the latter we can produce figure in any part of our cloth, with the swivel shuttles we are limited in the extent of pattern to the horizontal movement of the swivel "rack." The methods already shown of putting extra weft figures on point paper are equally applicable to this.

Spotting with extra warp has perhaps its simplest expression in those fabrics ornamented by small spots which are produced by the use of healds. What has been said about the methods of distributing pattern, the floating of material from spot to spot, and the binding of the figures to the ground cloth to allow of the waste material being cut away, is equally applicable to extra warp spotting, so that one or two examples will be sufficient to show how



A

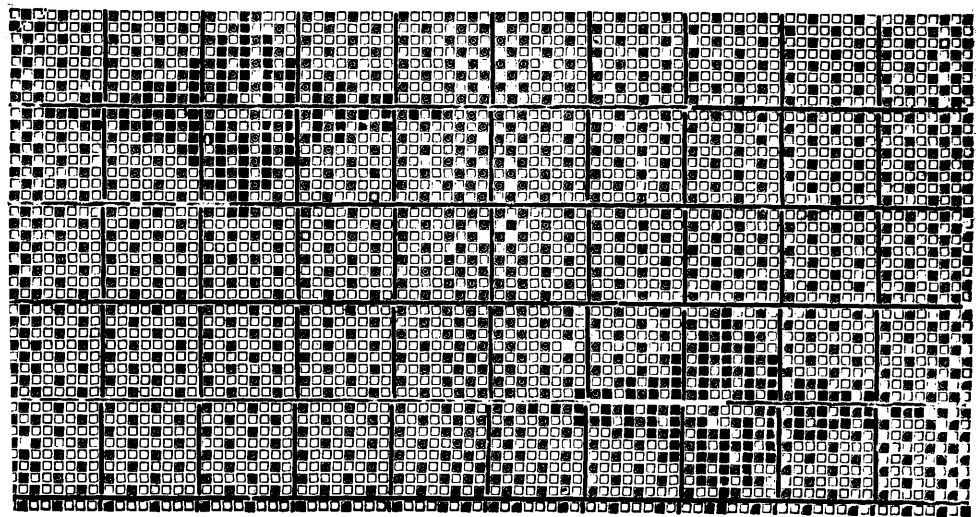

B

Fig. 198

these patterns are put on point paper. Let A, Fig. 198, be the figure motive, arranged in plain cloth order on 48 ends and 48 picks, the ground to be plain cloth. As these patterns are arranged end and end at the spotting portion, we have B, in the same figure, as the pattern on point paper. It will be seen from this that, as when spotting with extra weft, the figuring material floats on the back of the cloth, and cannot be bound into the ground cloth without it being seen on the face. If it is necessary to cut

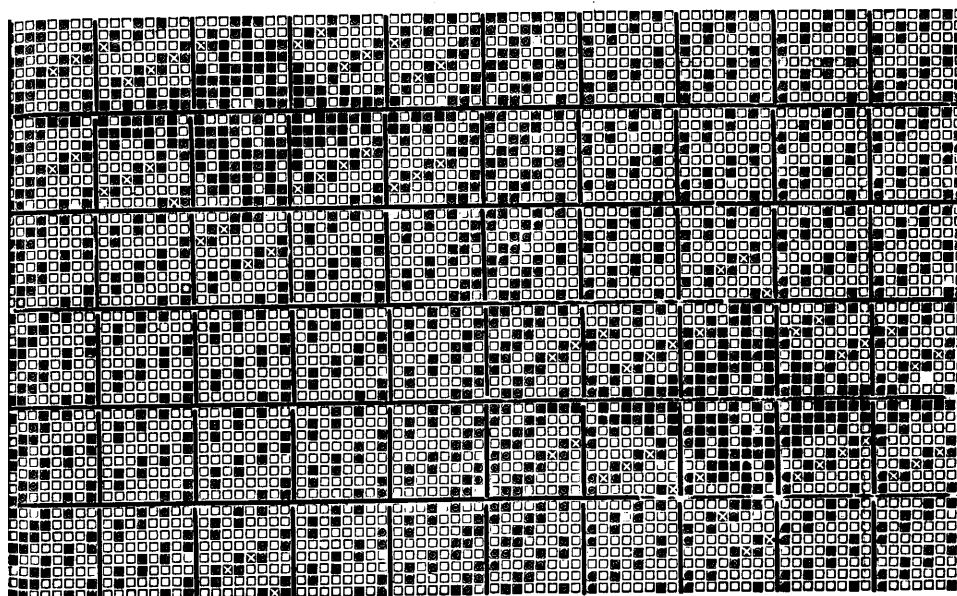

FIG. 199

this material away we must either bind the spot round the edges, or bind the spot itself to the cloth by employing some twill or satin weave, or we must alter the weave of our ground cloth so that the binding points of this extra material will not be seen on the face. To illustrate this, let us take the same figure motive and arrange it similarly to our last, but change the ground weave to a four-end twill, two up and two down, Fig. 199. By bringing up a figuring end between two floating ends of the ground warp, we secure the spot to the ground, such binding points being hidden; and

the loosely-floating material running from spot to spot could be cut away.

The arrangement of healds for weaving such fabrics as these is

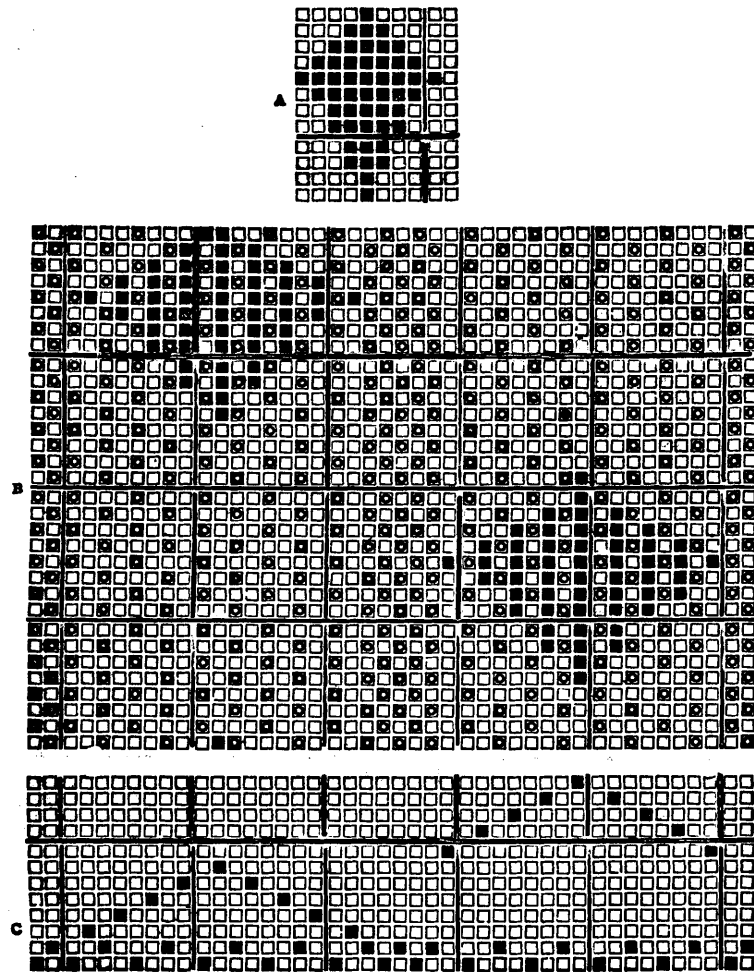

FIG. 200

a very simple matter, the first staves being occupied by the ground warp, the staves for the figuring warp being placed behind, while the denting of the reed is generally at the rate of two ground two

figure in one dent where the extra material comes, and two ground in the other portions. Of course the figuring warp is placed upon a separate beam. One example, Fig. 200, will illustrate this: A is the figure motive, arranged at B as plain cloth on a given number

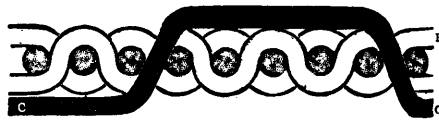

FIG. 201

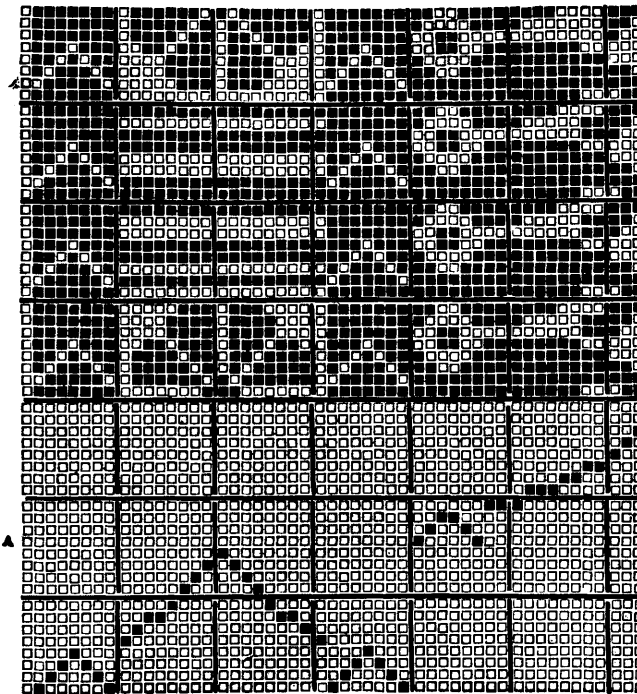

FIG. 202

of ends and picks, c being the draft which may be used for drawing-in purposes, as it shows the relative positions of the ground and figuring healds to each other.

It needs but that this method should be carried a step or two further, and we have such fabrics as figured dhootie borders and

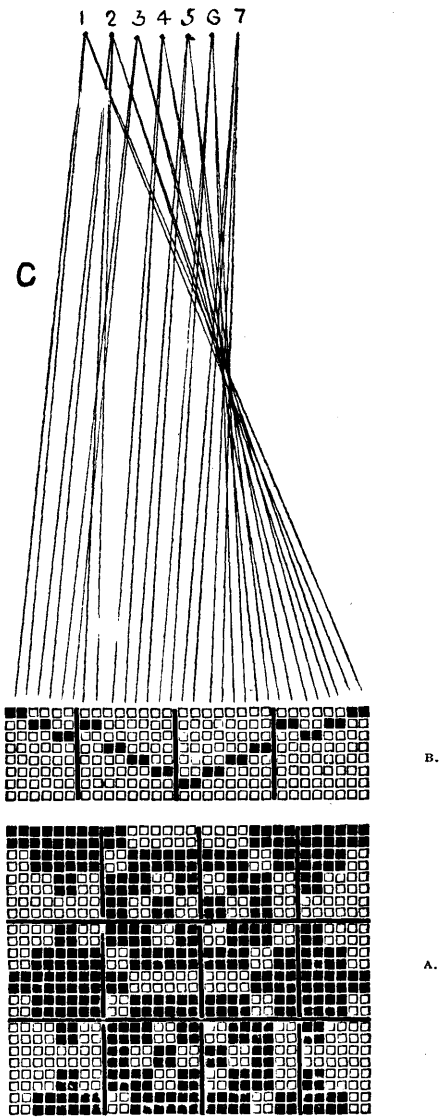

FIG. 203

alhambras, the first being simply a plain cloth figured along the sides with extra warp; the second, a plain cloth entirely ornamented by extra warp, which, being operated by a Jacquard machine, may be made to express any form of ornament as regards its outline. The construction of both these cloths may be illustrated by the sectional sketch, Fig. 201, the picks of weft being shown in section A, B B being ground threads, and c a thread of figuring warp, which, after coming to the face to produce its portion of the figure, is immediately passed to the back of the cloth. Fig. 202 may be taken as a typical example of figured dhootie designing, the figure portion only being put upon point paper, as the ground threads are drawn through the ordinary healds, the whole being dented, according to the fulness and density of the "cramming" necessary. Proceeding to get out the draft as we should for any other pattern, we have A in the same figure, which has now to be used to show how the mounting is to be attached to the lifting jacks of the dobbie. We have said that the principle of drafting is—"That all threads which lift alike in a pattern may be drawn through the same stave of healds"; and so all threads which lift alike in a pattern may be tied up to the same jack. This will be better understood by reference to Fig. 203—a small pattern which will do to illustrate the method. Let 1, 2, 3, 4, 5, 6, 7 represent a corresponding number of jacks in a dobbie, A the pattern, B the draft, and c the mounting. Upon examining our draft we see that Nos. 1, 2, 29, 30 threads lift alike, and may be tied up to the first jack, as shown; that threads Nos. 3, 4, 7, 8, 23, 24, 27, 28, lifting alike, are tied to the second jack, and so on for the others, the mounting threads c being dropped through a comber board so as to stand immediately behind the ordinary healds.

If we have to produce a large and intricate figure, the outline of which assumes a complicated form, the Jacquard machine will have to be used, as dobbies are too limited in their capacity for such work as this. Since we may have our figures to arrange (A) in straight lines running up and across the cloth upon a plain, twill, or satin ground; or (B) in plain, twill, or satin order upon a plain, twill, or satin cloth ground; or (C) in any one of these orders upon a figured ground; it follows that special tie-ups will be required.

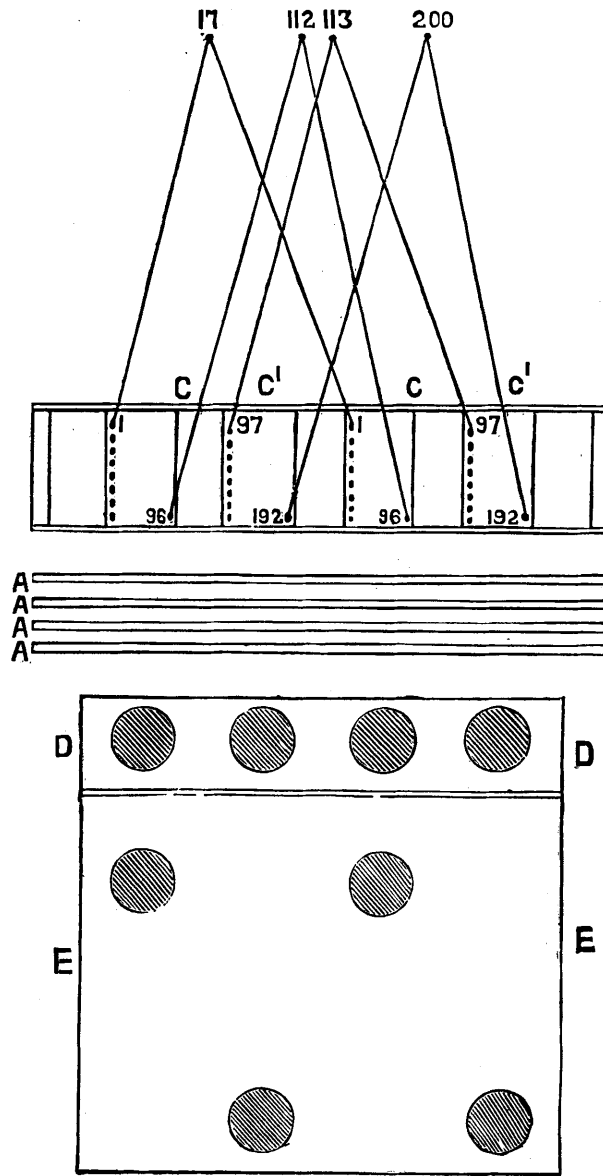

FIG. 204

The mountings used for producing such cloths usually consist of a set of healds, placed in front of the Jacquard harness, varying in number to suit the ground cloth. Through these the ground warp is drawn, whilst the extra figuring warp passes through and is governed by the Jacquard harness. This is illustrated by the plan sketch Fig. 204.

In this plan of a mounting and tie-up, let A A A A represent four staves of healds; B the comber-board frame; c c, c¹ c¹, comber slips placed in their frame B so that they will fall over and opposite to the required position of the spotting warp. Using, say, 192 hooks of a 200 Jacquard machine, and dividing them into two equal parts, so that one half of the machine shall command c c, and the second half c¹ c¹, we connect hooks 17-112 to couplings 1-96 in boards c c, and hooks 113-200 to couplings 97-192 in boards c¹ c¹, as shown. Let us now see how this mounting is used for (A), where the figure is arranged so as to run in straight lines across the cloth, as at D; and (B) where the figure is distributed over the face of the cloth in plain order, as at E. The heald staves A A A A, through which the ground warp is drawn, are actuated by tappets placed outside or under the loom, according to convenience; at the same time, the whole machine is engaged in the production of the figure from a set of cards which has been cut from a design arranged on 192 ends and a number of picks equal to the length of the spot. Upon the completion of the pattern, the card cylinder is stopped from turning over just as a blank card, which has been inserted as the last of the pattern, comes opposite to the needles, so that all figuring is stopped until the next repeat. This is effected by employing a measuring motion to operate the card-cylinder catch, lifting and holding it up whilst the plain cloth is being made between each row of spots.

By this arrangement of parts it will be readily seen that a great economy in the use of cards is effected, for if the healds were tied up to the machine, or if no provision were made for stopping the card cylinder, we should require as many cards as picks in one complete repeat of the pattern. This equally applies in producing fabric E, with the exception that the design would be arranged in plain-cloth order on 192 ends and picks, and that each half of the

machine would alternately be called upon to produce its part of the design. But much of this will be modified in (c) spotting with extra warp upon, say, a brocaded ground cloth—no healds will be required, and the tie-up must be planned so as to meet the requirements of both. This may be illustrated by sketch plan of tie-up Fig. 205. Let us suppose that a 400 Jacquard machine is to be used. We may take hooks 1-192 for the brocade portion A A, whilst for the spotting mounting hooks 193-288 may be used for

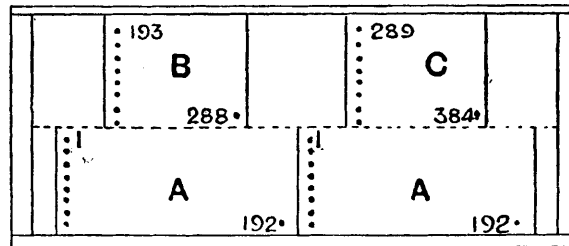

FIG. 205

portion B, and hooks 289-384 for portion C. By such an arrangement as this the spots may be put upon the ground cloth in straight lines or in plain order. Of course this is only a suggestion to illustrate the method which obtains in dealing with fabrics of this character; for if we only consider that a Jacquard machine may be divided up into as many parts as we have kinds of work to do, it will be seen how varied the tie-ups may be. In putting the design upon point paper, using such a tie-up as this, we should have, brocade on the first 24 bars; spotting portion B on bars 25 to 36; and C on bars 37 to 48; so that we have two designs running side by side on 384 ends and as many picks as may be required.



FIG. 206

We now come to a use of extra warp material represented by such cloths as Alhambras and Lappets—the first being a heavy domestic

cloth, which is simply a plain weave ornamented with extra warp, and having a section as shown by Fig. 206; the second, a light ornamented fabric, across the face of which a figuring thread is carried so as to produce spot or other small figured effects, the character of which may be shown by Fig. 207.

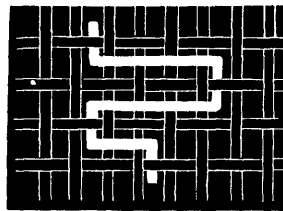

FIG. 207

Alhambra weaving is but an extended dhootie border weaving, as the relation of the extra figuring warp material to the ground cloth is the same in both cases. It is only that in one we have a narrow strip of figure down the sides of the cloth, in the other the figuring material is extended all across the piece; and so what at first sight appears to be an elaborate piece of weaving, is really but a fabric of very simple construction, though the design itself may be of a highly floral character. The mounting employed will be readily understood by reference to Fig. 208, where A represents one row of hooks and needles of a Jacquard machine; B the harness threads connecting machine to couplings; C, a comber board; D, two staves of healds placed in front of the Jacquard harness; and E, the yarn when drawn through the mounting and healds. Two warps are used—one, the figuring material which is brought forward and drawn into the Jacquard mounting and between the healds, the other the ground warp which comes between the harness and is drawn into the healds in plain cloth order. It will be seen from this that, by actuating the Jacquard machine A, we actuate the figuring warp only, the individual threads of which may be lifted in any order and at any time we like; whilst the alternate lifting of heald staves D produces plain cloth with the threads coming from the ground beam. The healds D are actuated by a pair of tappets placed outside the loom, the Jacquard machine A, in the

so if we are to have whatever comes against the selvedge of border A to come also against the selvedge of border B. It will, of course, be understood that the tie-ups used for these fabrics are modified to suit the requirements of the design. It might be that the design for the border, requiring but a few hooks, as instanced, would have to be repeated over and over again, so as to give the width of border needed; or that the centre of the fabric might be made up of only one repeat of some large centred figure; or the borders might be tied up to a centre tie, the middle remaining straight.

The yarns used are of a coarse character, the extra warp, say 24s coloured, drawn about four in a mail; the ground about 18s or 20s grey, drawn one in a heald; and the whole entered one ground and one mail full in each dent of the reed; whilst the weft is usually made from bleached waste.

In lappet weaving a new set of conditions obtain—the extra figuring thread is not passed from one side of the cloth to the other, there to remain for as long as may be desired, as in the case of Alhambra and other extra warp figure weaving; it is not put through a shed, as is the case in swivel weaving; neither is it operated by any heald or Jacquard mounting. Instead of the above there is a system of cross-weaving in front of the reed, where a lateral as well as a vertical movement is imparted to the figuring thread—the lateral one producing the pattern, the vertical one attaching the thread to the ground cloth—these operations producing a figure which has the appearance of having been worked by an embroiderer's needle. If we examine the parts which have this work to do we shall have a better appreciation of the niceties of setting out and arranging the patterns than if we simply gave a mere description. Taking away all parts which might lead to complication, we have at Fig. 210 a sectional sketch of a lappet lay, with its accompanying parts, such as is used in Lancashire for this class of work. A is the race board of the lay; B, the reed casing set back for the accommodation of pin and needle frames E, F; C, the reed; D, the lay cap; E, the pin frame which acts as a false reed for guiding the shuttle across the loom; F, a needle frame into which eyed

needles are placed according to the requirements of the pattern, and which may be multiplied in number; *c*, a whip thread brought from a whip roll placed conveniently at the back of the loom. The whole, being attached to the lay, has a vibrating to-and-fro

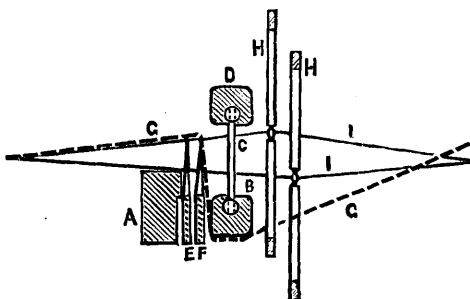

FIG. 210

motion in common with that part of the loom. *H H* are a pair of ordinary healds through which the ground warp *I I* is drawn. By the backward sweep of the lay the pins and needles of *E F* are lifted through the yarn forming the bottom shed, by which movement the needle frame *F* carries the figuring thread *c* up to

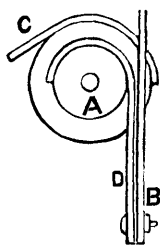

FIG. 211

the level of the yarn forming the top shed. On the forward motion of the lay, *E F* drop down into the recessed part of the lay, thus enabling the reed *c* to beat up the inserted pick of weft, so that the figuring thread *c* is attached to the cloth by every vertical movement of *F*.

The vertical motion of the pin and needle frames $E F$ is obtained as shown at Fig. 211. A spindle, on which are mounted two rollers, is supported by brackets attached to the lay swords. Hanging from the smaller roller A is a strap B , which supports the vertical lifting rod D ; from the larger one a strap C is fixed to the front cross rail of the loom, so that, on the lay taking its backward stroke, strap C causes roller A to wind on the strap B , and of course, lifts the rod D , which is directly connected to the pin and needle frames. As the lay comes forward to the fell of the cloth strap B is given off, so that the frames and their supporting rod D are lowered, out of the way of the reed when beating up. By a recent modification of this particular part, the motion is made a positive one, which does away with the risk of the needles being caught.

Coming now to the horizontal motion of the needle frame by which the pattern is produced, we have at Fig. 212 a sketch of the front and end view of the necessary wheels used. The numbers in each refer to the same parts. A is a strong pawl, supported on a bracket fixed upon the framework of the loom; B is a ratchet wheel; fixed upon the same stud as B , and moving along with it, we have the

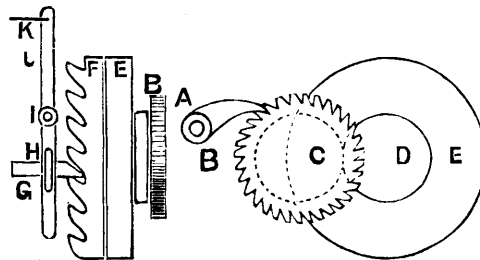

FIG. 212

pinion wheel C , which gears into a second one D ; upon the same stud as D we have a metal disc E , to which the pattern wheel F is bolted, and so constructed that the feeler G may rest in the bottom or on the top of a tooth; G commands a vertical lever $H J$, which has its fulcrum at I ; to the arm J a cord or wire is attached, the opposite end of which is made secure to a pendant arm fixed to the needle frame.

By this disposition of parts it will be readily seen how motion is conveyed from the ratchet wheel B , through the pattern wheel F ,

and on to the cord κ . Since the several parts are attached to the lay sword, we have B presented to the pawl A on every forward movement of the lay, and by it pushed through the space of one tooth. This space is equal to presenting the bottom or top of a tooth of the pattern wheel F to the feeler G , so that, on two consecutive picks, the feeler G rests in the bottom and on the top of a tooth—this traverse representing the amount of movement imparted to the needle frame.

The driving of the pattern wheel, as shown at Fig. 212, is also part of the recent modification already mentioned. In the old form of this motion the ratchet and pattern wheels were bolted together, which meant that for every new pattern wheel a fresh ratchet was required; but by the introduction of the two pinion wheels, which are really change pinions, the correct pacing of the pattern wheel may be ensured, and the ratchet becomes a constant wheel of a train. The success of lappet weaving depends upon the accuracy and correct setting of the parts we have already illustrated, as well as the nicety with which the vibrators act upon the figuring threads—giving off and taking up thread as the needle bars rise and fall. The setting-out, cutting, and pacing of the pattern wheel determine whether or no the figure is correct in form, whilst the action of the vibrators may or may not pull or loop the edges of the figure so as to make it almost shapeless.

The patterns used for lappet work are very simple in character—small spots, sprigs, simple continuous curves, or pointed zig-zag effects running the length of the piece. And this must necessarily be so when we consider that the whole figure lies upon the cloth, that no shaded or varying weaves can be used for the get-up of the figure, and that the thread is only attached to the cloth at each end of the float—features which are peculiar to this class of weaving, as illustrated by Fig. 207. Of course we may employ two or more of the above-mentioned patterns in the production of some new design, as instanced by Fig. 213, an ogee pattern with small spots placed alternately to each other in plain-cloth order. But it must be borne in mind that multiplication of detail in a pattern means multiplication of figuring frames—that, if two portions of a design having dissimilar floats are to be made at the

same time, two frames will be required, and that we shall be compelled to have two frames if the lines composing our design run in opposite directions. All this is instanced in the pattern just given. The centring over of the curved lines compels the use of

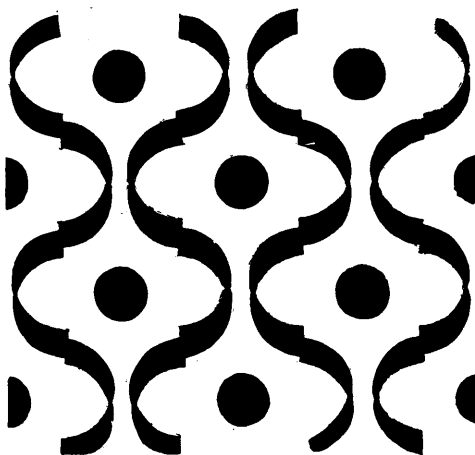

FIG. 213

two frames, and a third will be needed for the small spots, which shows that though we may produce comparatively large figured effects, the design must be made by a repetition of similar

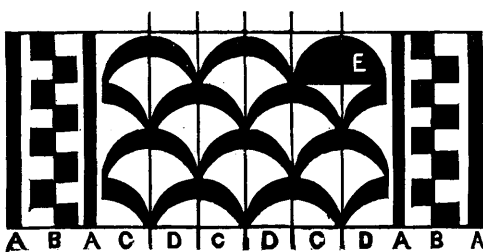

FIG. 214

detail. As another illustration of this, let Fig. 214 be a suggestion for a border running down one side of a cloth—A A A A are corded effects produced from the ordinary ground warp; B B a small chequered effect requiring one needle frame; C D a shell pattern

which may be repeated as often as may be desired for the width, and requiring two frames to make it. This portion of the pattern could not be made with one frame, as we should have the result shown at E, so that of the two frames used one will make portion C, the other portion D—a working together of two frames by which the convex and concave outlines of the several shells may be obtained.

The method which is used for constructing the pattern wheels is very simple. The upward movement of the needle frame is of such a nature that we cannot ensure ourselves that the figuring thread will be brought up on this or that side of two threads, whilst it is impossible to move the pattern end by end when such ends are drawn two in a dent. It follows, then, that the teeth of the pattern wheel must be cut to the counts of the reed we intend to employ. Let Fig. 215 be a small spot pattern occupying 32 ends and 32

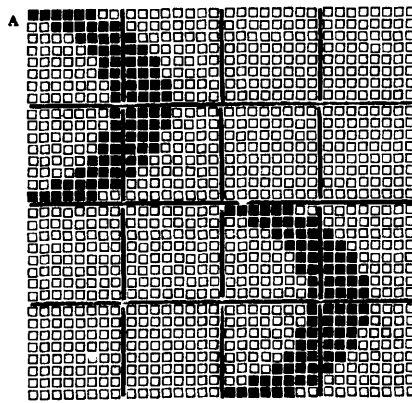

FIG. 215

picks, for which we want a wheel. Taking a strip of paper equal in length to the circumference of the pattern wheel, divide it longitudinally into 32 equal spaces which shall correspond to 32 dents of, say, a 64 reed, and we have A, Fig. 216. But since the figuring thread must be bound at each end of the float, we must divide this scale into 64 equal parts pick way. Having correctly constructed the scale, we can now transfer the design to it; but in doing so, the divisions of the design paper must be taken as

representing DENTS and double PICKS, not ends and picks. Beginning,

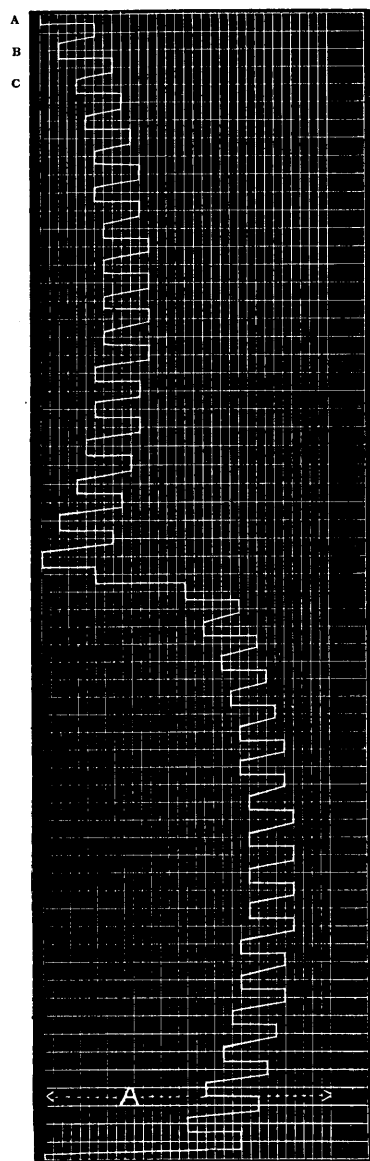

FIG. 216

then, with the top pick of the pattern A, Fig. 215, we see that it has a float of six dents, which is marked on the scale at A, Fig. 216; that the next pick misses two dents and floats six, B, Fig. 216; the next misses four dents and floats five, shown at C in the same figure, and so on for every pick. Having thus made the scale, it is fastened round the drum from which the pattern wheel is to be made the front edge of which is cut away to the exact shape and depth of the zig-zag line on the scale which is the transcription of the pattern. It will be seen from this that the cutting of the wheels is a nice piece of work, requiring very great care in its execution, as the least error in the depth of a tooth will be transferred to the pattern.

The particular motion we have illustrated has one great fault. We have shown at Fig. 211 how the vertical movement is given to the needle frames, and that this takes place at every pick of the shuttle. This means that we cannot make such detached figures as the spots shown at Fig. 213 without carrying into the ground cloth what should otherwise be a loose floating

thread which could be cut away upon the completion of the weaving. There is now in the market a lappet motion by which any figuring frame may be left out of action as long as may be required, so that detached figures may be made any distance apart. This will be fully illustrated and explained at a later stage.

The Lancashire lappet motion has an advantage over other motions. It is contained within the framework of the loom, and it may be applied to any ordinary plain loom. But in applying it it is advisable to increase the sweep of the crank, so as to allow more shuttle space, which minimises the risk of dragging the figuring threads, and, where possible, it is preferable to have a loom several inches deeper from front to back than is found in the generality of cases. This gives more interior space. In the Scotch lappet loom we have an entirely different disposition of parts. The needle frames are placed on the lay cap, and are pulled down when attaching the figuring thread to the cloth; whilst the lateral movement of these is obtained from a pattern wheel placed immediately above the shuttle-box. The movement of pin and needle frames is obtained from treadles and tappets placed at one side of the loom. But it is the pattern wheel which is the part of greatest interest to us. It is a ratchet wheel, to which is fastened a disc of wood. A groove cut into the face of this is occupied by a bowl or "peck" attached to one end of a link which governs the needle frame, and since this "peck" is made to move from side to side of the groove on consecutive picks of the shuttle, it follows that the width of this groove determines the lateral traverse of the needle frame. By taking one example we shall see how this pattern wheel may be constructed. Let Fig. 217 be the pattern complete on 16 picks and 10 ends. Reading the vertical spaces as dents of some given reed, this pattern indicates that we are to lay off the ratchet wheel and disc into 16 equal parts by drawing radial lines 1-16 Fig. 218; and that the face of the disc must be divided up by drawing 10 concentric rings to the pitch of the reed used. But since the bowl or "peck" which has to work in the groove to be made is of a given diameter, say, equal to four dents, these must be added to the dents occupied by the pattern, by which we get 14 as the total divisions to be made upon the face of the disc.

Reading the radial lines as picks, we have marked off at No. 1 eight units of space, which equal a float of four dents in the pattern plus four for the diameter of the "peck;" for No. 2 the same number of spaces moved two to the right, as required by the pattern. This proceeding is followed until the pattern is complete on the sixteenth pick. If it were desirable that the pattern should

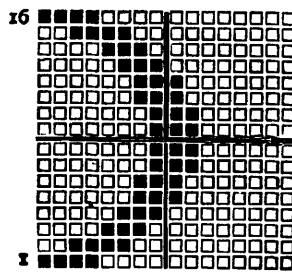

FIG. 217

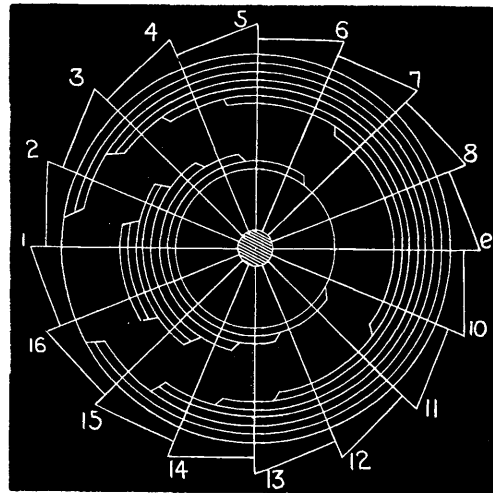

FIG. 218

be woven as a spot, the needle frame at this point would be kept out of action until the next repeat, but if as a continuous pattern, then No. 16 pick would be immediately followed by No. 1. In this particular form of wheel, two patterns may be cut upon it, on condition that both are complete at the same time.

It will be seen from the illustrations of the Lancashire and Scotch lappet motions that the laying out and cutting of the pattern wheels is one of those nice pieces of work requiring a fair amount of technical skill as well as a knowledge of the capacity for pattern production of these particular motions. To this must be added the costly item of producing a new pattern, a new wheel being required in each case. It follows from this that any modification of parts which will do away with the necessity of pattern-wheel cutting will be welcomed by the lappet weaver, and much more so if the modification offers a scope for pattern production only limited by the limits common to any pattern chain and the lateral traverse of the needle frames. Such a one is now before us in Galloway's patent lappet motion.

The inventor claims for his motion the following advantages:— That any length of pattern can conveniently be made; that detached spots can be made so as to leave the figuring threads free between the spots; that any needle frame can be selected and called into action for figuring purposes, irrespective of the others; that all needle frames are actuated from one pattern lattice; that the production of pattern is limited only by the limits imposed by the lateral traverse of the needle figuring frames; that the pin frame, which acts as a shuttle guide, has a positive motion imparted to it; and that the motion can be applied to any ordinary loom. These are advantages that ought to recommend its general adoption by those intending to manufacture lappet goods.

Fig. 219 is a front elevation, showing how lateral as well as vertical motion is imparted to the needle and pin frames: A is the lay sword, upon which a strong bracket is fixed to support a ratchet wheel c, upon the spindle of which is the lattice barrel D; B is a strong pawl, fixed upon a bracket attached to the framework of the loom; it engages with c on the forward stroke of the lay, so that c is pushed over one tooth, and, of course, with it the lattice barrel, the extent of movement being equal to the distance from centre to centre of the lags E going over the barrel. F F F F are the feelers, kept in position and guided by passing through a perforated plate: these hang from the ends of bent levers, G G G G

From this disposition of parts it will be seen that by lifting up F a lateral movement is imparted to κ, F being raised by inserting a peg in ε, and

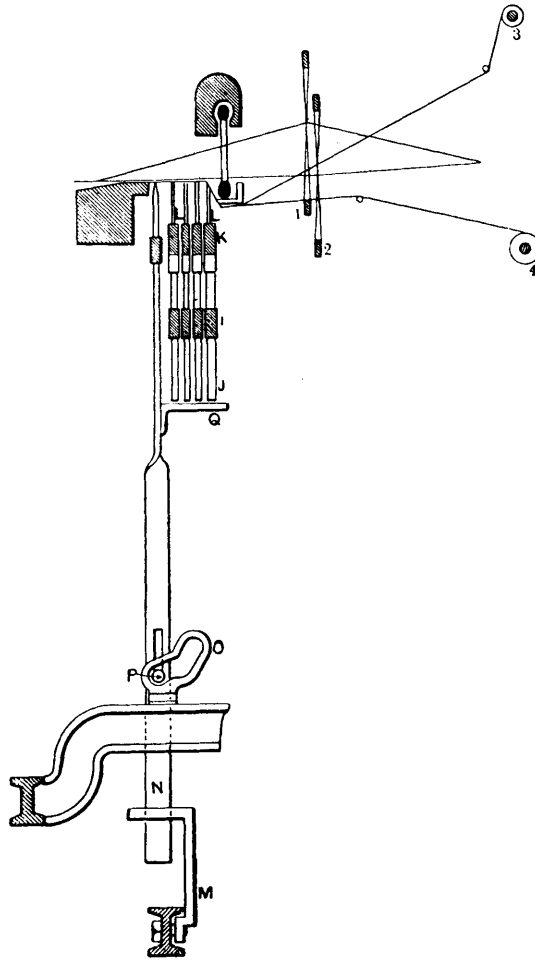

FIG 220

that if the pegs are made of varying lengths, then a corresponding traverse is imparted to κ .

The vertical movement will be better understood by reference to Fig. 220—an end elevation of the frames and lifting mechanism. m is a slotted bracket fixed to the rocking shaft, and acts as a guide and stay to the lifting-rod $n n$. On this rod at p is a stud and friction roller, working in the swan-neck o , which is firmly bolted to the cross-rail of the loom. o by construction may be made to impart any quality of movement to n . As the vibrating movement of the lay brings the friction bowl p in contact with first one and

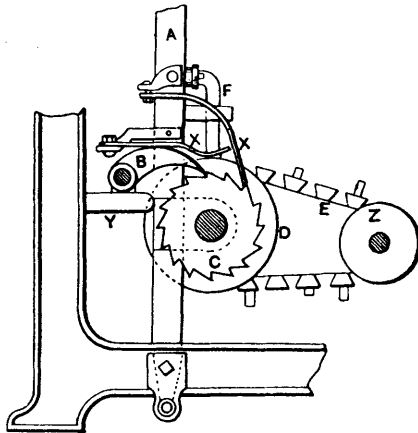

FIG. 221

then the other side of o , the pin frame s , Fig. 219, and pins r are lifted and depressed for every revolution of the crank. But not so the slides and needle frames $i \kappa$. On the lifting-rod n is a small plate or table q . If one of the feelers f is lifted by inserting a peg in the lattice e , then the pin j , which commands a needle frame, is pushed so as to be over q , and hence the vertical lift to one or all of the needle frames, which simply means that no peg in the lattice leaves j out of the way, and it is not affected by the upward movement of q . This figure also shows the course of the figuring

yarn. Whip rolls, 3, 4, Fig. 220, are placed conveniently behind the loom. From these the threads are taken under and over guide rods, between the ordinary healds, under the reed casing, and are then drawn into the needles *L*, which are eyed for the purpose of receiving the thread. The threads from any one whip roll are placed in the needles of one frame. Healds 1, 2, command the ordinary warp.

Fig. 221 is an end view showing the mounting of the lattice cylinder and its driving. Any tendency to overdrive *D* is prevented by strong bow-springs *x x*, one acting upon the teeth of the ratchet wheel *c*, the other on the rim of cylinder *D*, and, of course, by the adjustment of pawl *B* upon its bracket *v*. Lengthy pattern chains are assisted by being carried over a second drum *z*, which is held upon a rod connected to the lay sword. The pegs used for this motion have a strong square section and are made of varying lengths. They are at present made with a variation which progresses by 1-32 in. The number of different pegs in the series is 36, beginning with one $\frac{3}{8}$ in. and going up to one of $1\frac{1}{2}$ in.

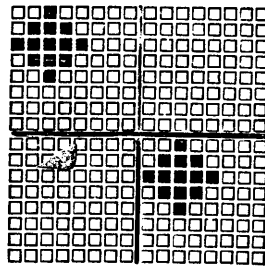

FIG. 222

in length. To prevent the pegs from being broken by coming in contact with the feelers *F*, a link motion on the opposite side of the loom draws the slides *I* to that side. This acts just as the cylinder *D* is being turned over; consequently the feelers are dropped on to the pegs so that the faces of pegs and feelers come true to each other.

Though there are several other ingenious arrangements connected with the motion, it is with the practical application of

a pattern that we are most concerned. We have said that pattern production is effected by using pegs of varying lengths.

At Fig. 222 is a small pattern, chosen because it is as suitable as any other to illustrate the method of applying a pattern to this particular motion. Reading this as we have read other patterns

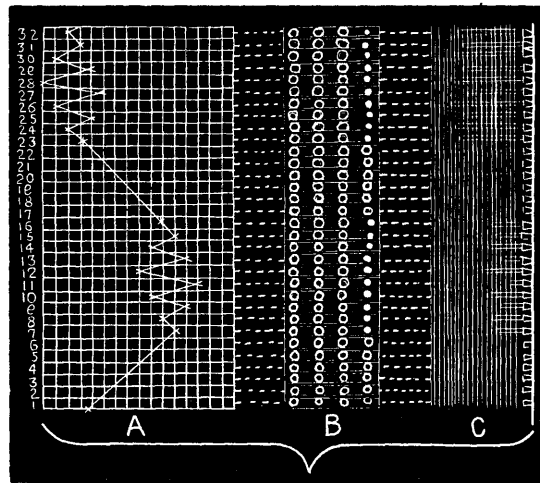

FIG 223

for a similar class of work, we proceed to make a scale plan of one repeat of the pattern which shall show us the lengths of the several floats and their binding—a plan which is simply an analysis of what actually takes place in producing the fabric, and represents 16 dents of a given count of reed and 32 picks, as shown at A Fig. 223. Reverting to the pattern, we see there are six picks without figure, but that on the seventh pick the figuring thread is brought up between the fifth and sixth dents; for the eighth pick between the sixth and seventh dents, and so on for every pick of the pattern. Indicating these floats of the figuring thread by small crosses on their respective picks and dents, and connecting these by lines to represent the figuring thread carried from point to point, the first half of the pattern is complete. The second half is a repetition of the first, carried eight dents further on the scale. This is how all patterns for the motion may be analysed, and from such a plan the lattices are pegged,

as seen at B in the same figure which shows the pegging for the pattern—1-6 blank, 7-16 pegged, 17-22 blank, 23-32 pegged, as indicated by the rings and dots. But since the varying lengths of these pegs decide the amount of lateral movement imparted to the frame, we have at C an end view of B, where, as shown by the vertical lines, the pegs vary in length correspondingly to the spacing by the vertical lines in plan A—a simplicity of procedure in pattern production not attained by any other lappet mechanism.

CHAPTER X

OPEN WORK EFFECTS

THE fabrics that come under the heading of "open work effects" are known by such names as canvas and mock lenos all of which owe their open, perforated character, to the unequal distribution of warp and weft threads, which are made to contract and run in groups instead of spreading out and distributing themselves to give us a fabric of equal thread and space, such as is found, say, in plain cloth. None of these effects are the result of partially or wholly twisting one set of threads around the other, as in those open

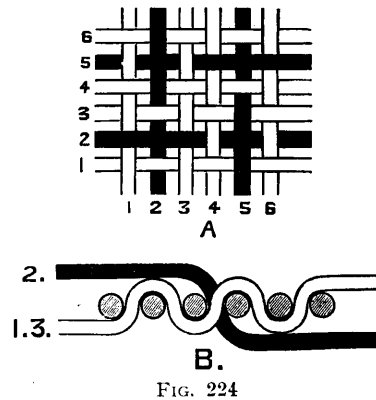

FIG. 224

work effects known as gauze and leno; but are the results of using tight and slack threads, this comparative tightness or slackness being obtained by interweaving threads with a varying number of intersections. If we examine the plan of a six-end and six-pick canvas, shown at A, Fig. 224, we find that ends and picks (1, 6) (3, 4)

interweave in plain-cloth order, thereby making the greatest possible number of intersections with each other, while the ends and picks 2 and 5 make only two. Thus, while those ends and picks making the greater number of intersections, separate from each other and cause the loosely floating ones to be forced out of their places and lie in ridges upon the face and the under side of the cloth. This is shown by the section B in the same figure, which is an analysis of the first three picks of the plan A. But the openness of build thus arrived at may be intensified by the manner in which the ends are dented in the reed. Suppose the ends composing plan A to be dented three in a dent, we should have more openness than if dented two in a dent, because the first and third ends, which are working exactly alike, would work as one thread, and no reed metal would interfere to keep them apart. This openness may be still further increased by alternately denting the reed—say, one dent full one empty; or, as in many effects belonging to this class of fabric, one dent full and one or more than one empty—methods which obtain in designing the build of all fabrics belonging to this class.

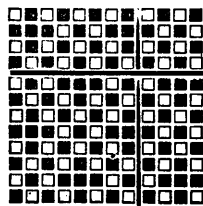

FIG. 225

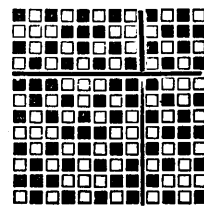

FIG. 226

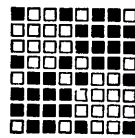

FIG. 227

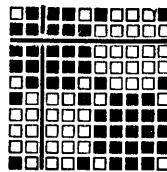

FIG. 228

In Figs. 225-232 are given some of the more commonly used weaves for open work effects.

Figs. 225 to 228 are canvases complete on six, eight, and ten ends and picks respectively.

Figs. 229-232 are mock lenos, complete on six, twelve, and ten ends and picks patterns dented in a great many ways, according to the desired openness of the fabric.

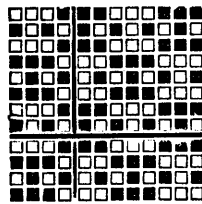

FIG. 229

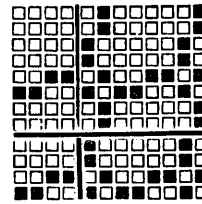

FIG. 230

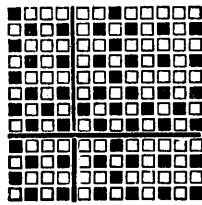

FIG. 231

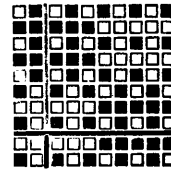
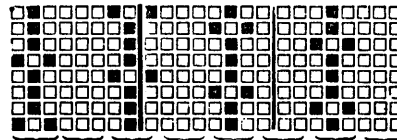

FIG. 232

Fig. 233 is an open work effect complete on twelve ends and four picks, and is reeded three ends in a dent, one full and one empty.



Denting
FIG. 233

Fig. 234, another pattern not unlike the last, is complete on four ends and six picks, and is reeded four ends in one dent and one dent empty.

Perhaps the most useful application of these patterns is when they are combined with other weaves, in either stripe, check, or all-over forms. The canvas-weaves, for instance, are often used as grounds to brocaded goods, and are commonly used in contrast to twills and satins in getting-up parts of ornaments applied to these

fabrics. But such a use imposes conditions upon the designer which cannot be neglected, as the indiscriminate employment of such weaves will produce so loose a cloth that the practical utility of the fabric is destroyed. Wherever large masses of such weaves are used for grounds, the figure must be outlined with two or more ends of plain cloth, to hold in position the loosely floating material of the figure. The mock lenos are generally used in stripe form in conjunction with stripes of twill, satin, or plain

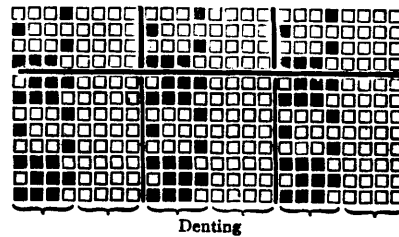

FIG. 234

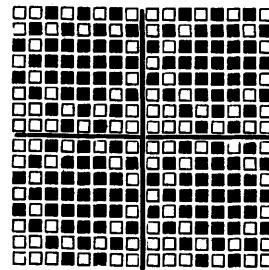

FIG. 235

cloth, these stripes being often ornamented with small brocaded or diaper figures, the reed dented and the healds spaced according to the required openness and width of the several stripes.

“Huckabacks” and “honeycombs” are cloths which owe their peculiar texture to the same method of interweaving tight with slack threads, as, for instance, the eight-end “honeycomb” shown at Fig. 235—the ends and picks weaving in plain cloth order form the hollows of the “combs,” forcing up into ridges the loosely floating ends and picks. This is a weave of very general application, modified of course by the nature of the material from which the fabric is to be made, and the use to which such a fabric is to be put.

CHAPTER XI

CORDS AND CORDED EFFECTS

THE simplest cord effect which can be produced has already been illustrated by Figs. 28 and 29, which show that, by making one set of threads predominate over the other, one set will lie in a comparatively straight line, the cord running in the direction of the straight threads. But there are other ribbed and corded effects which do not entirely depend on such methods of structure for their texture, other methods and considerations obtaining which greatly modify their build.

Repps, plain and figured, though having a plain cloth basis like the fabrics already instanced, are weave effects into which some of these modifying influences have entered, as will be apparent by the following :—Let A, Fig. 236, be a thread of coarse warp coming from

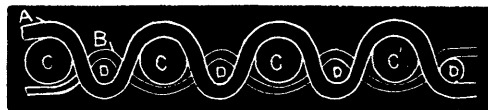

FIG. 236

its own warp; B, a fine warp thread placed alternately with A, and coming from a separate beam. This separate beaming of the two warps is necessary owing to the variable contraction in weaving. When all the coarse threads are lifted, coarse picks of weft C are thrown in; but the alternate fine pick D is thrown in when all the finethreads are lifted. Thus, by the alternate drafting of coarse and fine warp threads and the alternate insertion of coarse and fine picks of weft, the plain cloth build of the fabric is preserved,

but its character is entirely altered by the ridges which run across the piece from side to side alternating with the hollows formed by the thin picks. Such a fabric will be represented on point paper as so much plain cloth. But when we come to figured repp, though the ground of the fabric retains this simplicity of structure, we have an effect produced which gives to the cloth a richly ornamented appearance, not likely to be associated with plain cloth, the materials used being of a mixed character, such as cotton and worsted, or cotton and silk. The Jacquard machine being required for figuring purposes, we have a mounting which may be illustrated by Fig. 237, where A is the machine, B the mounting, C the comber

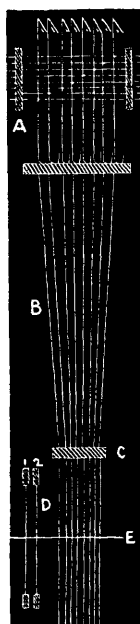

FIG. 237

board, D a pair of healds placed in front of the mounting, E the warp line from back to front of loom. The warps, as in a plain repp, are beamed separately, the coarse one being drawn into and governed by the Jacquard mounting, while the fine one is drawn into the healds, the threads being placed alternately into heald staves 1 and

2. It will be evident now that we may have—(A) all the mounting lifted and the healds left down ; (B) both heald staves lifted and the mounting left down ; (c) one or other of the heald staves lifted and the mounting down ; (D) one or other of the heald staves lifted and the mounting up ; (E) part of the mounting up or down and one or other of the heald staves lifted ; and (F) both healds up or down and part of the mounting lifted. By this independent or combined action of healds and Jacquard we obtain all that variety of weave found in this class of goods. An analysis of the cloths produced by these various liftings may be shown by sections :—A, B will give sections shown by Fig. 236 ; c, D, E by section Fig. 238 ; and F by section Fig. 239, which is an inferior cloth owing to the fine weft being thrown to the back of the fabric, as indicated by the † in the same figure, from which it follows that figure is produced by simply lifting the coarse warp over both sets of picks.

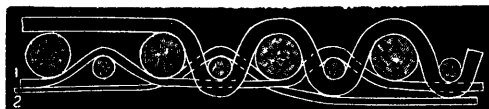

FIG. 238



FIG. 239

The designs for these fabrics may be anything in outline and form—if we regard the ultimate use to which the fabric is to be put—and are painted up in solid colour. Cutting the cards from this, we have as many cards as there are picks in the design ; but since figure is produced by carrying the coarse material over both sets of picks, we have as many solid cards to cut as figuring cards, and lace them alternately with each other. From these cards the sheds formed are :—From the solid card all the mounting lifted for the insertion of the coarse pick ; from the figuring card a portion of the mounting and one or both of the heald staves, into which shed the fine pick is inserted ; hence there is double the

number of cards in the set to what appears on the design paper. But by a slight modification of the working parts of the Jacquard one-half of these cards may be saved. We know that if no card is presented to the needles all the hooks in the machine will be lifted—which is equal to bringing to the needles a card cut solid—and that, by means of a separate cylinder motion, a card may be made to stand in or out for any desired number of picks. This being so, by making the cylinder present a figuring card every second pick, we have the shed for the coarse pick made by the machine when the cylinder is out, therefore needing no card, and the shed for the fine pick is made when the figuring card is presented to the needles—an economy of cards and card-cutting not to be neglected in making such fabrics as these. In many examples of this class the grounds are relieved by a figure which acts as secondary ornament to the principal one, the result of throwing into a special figuring shed a pick of fine coloured weft. This relieves the otherwise monotonous surface and, by contrast, the ornamentation of the fabric becomes more pronounced.

In “Bedford” cords we have a weave of a very general application, and whilst the cords are not the effect of making one set of threads predominate over the other, neither do they run across the fabric, but the whole length of the piece of cloth, the ribs being made prominent by well defined hollows which alternate with the several ribs of pattern. We may have these fabrics based upon (A) a plain cloth or (B) a twill weave, generally the latter; and since they are warp faced fabrics they may be ornamented by using colour in, say, alternate stripes, whilst for the heavier class of goods increased weight, strength, and thickness are often the result of using extra warp threads which act as wadding in the body of the cord. Taking the simpler form of these, Fig. 240 will illustrate the method of constructing all cloths of this class which are based upon a plain weave:—A is the weave design; 1-8 are warp threads forming one rib, while 11-18 are threads forming the second one; 9-10 and 19-20 are threads which form the hollows between the ribs by which these are made more pronounced. Analysing a portion of A—say, the first four picks and a part of each rib—the section B shows the actual build of the

cloth. Pick 1-2 are thrown to the back of No. 1 rib, and interweave with No. 2 ; picks 3-4 interweave with No. 1, and are thrown to the back of No. 2, and both sets of picks interweave with warp threads 9-10 and 19-20, which, making double the number of intersections to those forming the ribs, pull down the picks and so separate one rib from the other.

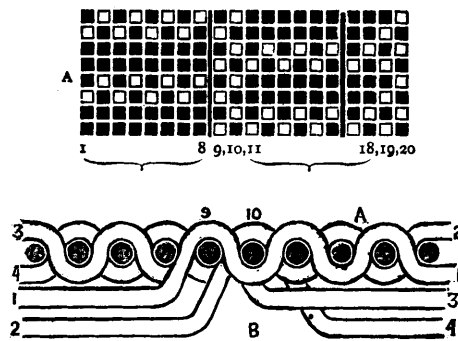
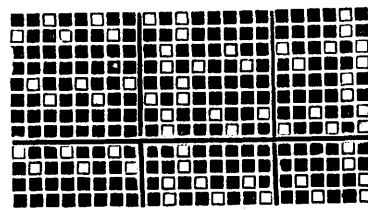

FIG. 240

The throwing away of half the weft to the back of the cloth is a distinctive feature in all "Bedford" cords ; and whilst in the heavier goods it offers a good back for raising purposes, in the lighter fabrics used for dress goods, it admits of using colour with great advantage, more particularly if woven in a box loom. For instance, the warp from which we desire to weave the given example might be beamed so that alternate stripes would be, say, pale blue and gold. Picking this with the same colours of weft, each interweaving with its own colour of warp, solid stripes of colour would be produced running up the cloth, whilst those ends forming the hollows between the ribs might be of another colour, which, of course, would have to harmonise with those used for the stripes.

At Fig. 241A is given the weave plan of a twilled cord, based upon the three-end twill, two up and one down, or the same might be arranged pick and pick, as shown at B in the same figure. The same method of structure obtains here as in Fig. 240, with the exception that the ends which form the hollows between the ribs

may not weave in plain cloth order. This will be obvious when we consider that in changing from a plain cloth rib to a twilled one the number of intersections in the body of the cloth has been reduced by a third, so that to allow these defining ends to continue weaving in perfectly plain order would mean that the strain



A

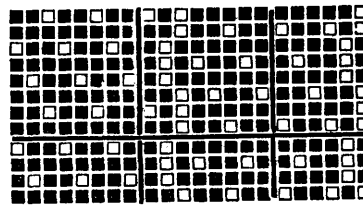

B

FIG. 241

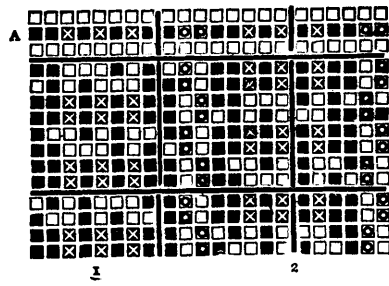

A

1

2

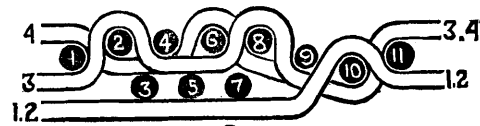

B

FIG. 242

put upon them would be altogether too great—in many cases the working of these ends does not make any approach to plain cloth.

At Fig. 242 is given a small example which will illustrate that make of "Bedford" cord where increased weight, strength, and thickness are obtained by using a second set of warp threads, which are to act as wadding in the body of the cloth. They simply lie in a straight line, making no intersections with the weft threads. At *a* in the figure is indicated the positions of the several warp threads which go to make up the design, the face ends are the solid black dots, the wadding ends are indicated by the crosses, the ends for the hollows between the ribs are represented by the small dots. Whilst the action of the latter and the face ends is exactly like the

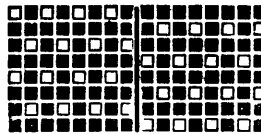

FIG. 243

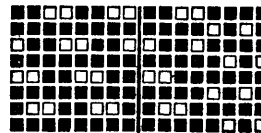

FIG. 244

action of our previous example, the wadding ends are lifted wherever picks are thrown to the back of the cloth and left down wherever picks are interweaving with face ends, thus lying between the face cloth and weft that is thrown away. Besides the qualities already mentioned derived from the additions of these threads to the body of the cloth, we have the further one of making the ribs of pattern more prominent, giving a more rounded section to each individual cord. This will be more apparent from the section of the first four picks put in the first half of the pattern, as shown at *b* in the same figure.

The first two picks are thrown to the back of the cloth, hence all warp threads in this cord are lifted; the second two are for figure, but interweaving only with the face ends, the wadding ends 3, 5, 7 being left down.

There are other corded effects made by the same method of cloth structure—as, for instance, Fig. 243, which may be based upon a plain cloth or a twill weave, or both combined, and which very often have their cords of unequal width, as Fig. 244; but they always lack the wadding, and the tightly weaving ends, which form the grooves of the last example.

CHAPTER XII

PILE WEAVING

PILE fabrics are characterised by the threads which issue from a body or ground cloth and stand out and away from it—in some cases giving the soft brush-like surface of velvet, plush, and imitation skins; in others, the looped surface characteristic of terry-towels and Brussels carpeting. Dividing these according to the manner in which the pile is distributed over the surface of the fabric, we should have (A), where the pile is constrained to run in lines up or across the cloth, and (B) where the pile is equally distributed over the whole surface of the fabric. But the more general division is according to which set of threads produces the pile—weft or warp. In one we have corduroys and weft velvets, plain and figured, in the other terry-towels, warp velvets, plush, plain and figured; tapestry, Brussels, Wilton, and Axminster carpets. Taking these as the generally accepted divisions of pile weaving, we have—

1. Weft Pile, plain and figured. Perhaps the simplest form of pile weaving is represented by corduroys, a fabric in which soft, brush-like ribs of pile run the length of the piece, these being well defined by hollows which disclose the ground cloth to which the pile is attached—the result of binding into the ground cloth in a certain order, those flushed picks of weft which are intended to make the pile. This is illustrated by A, Fig. 245, the common six-end and six-pick cord, having two pile to one ground pick, the ground plain cloth. By inserting the picks in this manner the plain ground picks are beaten up closely together, thus forcing the flushed picks 2, 3, 5, 6, upon the face of the cloth, as shown by a section of the first three picks, B in the same figure, where A is the

first ground, and B B the first and second pile picks. The continuous binding of all pile picks by the third and fourth ends of the pattern, causes the pile to run in straight lines, the flushing of the weft threads between binding point and binding point creating the "races" for the final operation of cutting. But it will be apparent that by using a plain weave for the ground a very close, heavy, or compact fabric can not be made. When these qualities are desired, we must have recourse to twill, or some other

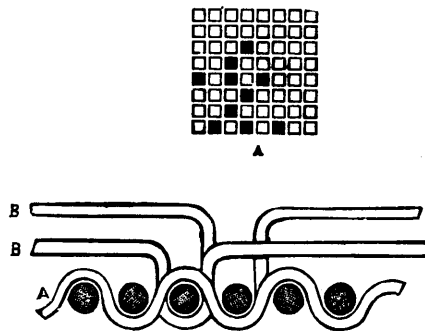

B
FIG. 245

weave for the ground, so that by decreasing the number of intersections which the ground picks have to make, more or heavier material can be put into a given space. Fig. 246 is an example of this, the ground employed being the two up and one down, three-end twill, having two pile, to one ground pick.

By a slight modification in the distribution of the binding points for the pile picks, *i.e.*, arranging them so as to have long and short floats, the cords have a decided roundness given to them. Fig. 247, A is an example of long and short pile, the first pile pick has floats of six and four, while the second has floats of four and six. The first three picks of this pattern are shown in section at B in the same figure, from which it will be apparent that if the "races" are cut at the v marks we shall have pile equal to a float of three and two respectively on the one side and the other of the binding point, and since the longer floats will occupy a position in the middle, and

the shorter ones on the outsides of the ribs, it will be seen that the comparative roundness of the rib, depends upon the selection of the binding points for the floating material.

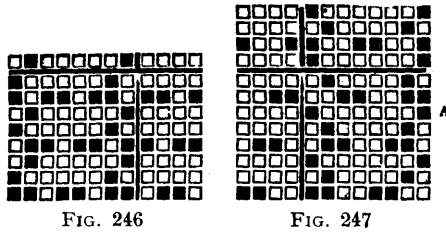
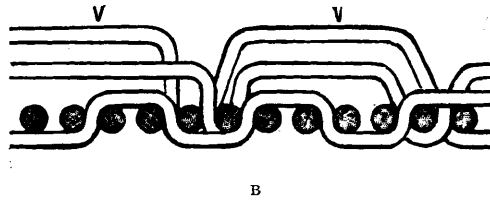

FIG. 246

FIG. 247



B

FIG. 247

There is another modification of this particular method of cloth structure, which is not very often used, viz., the reversible or double

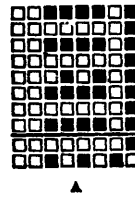

A

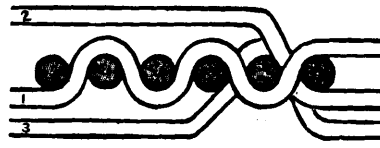

B

FIG. 248

cord. Yet the fabrics produced by this weave might be made of very general application if woven with suitable material. At A, Fig. 248, is given one of the simpler designs, complete on six ends

and ten picks, plain cloth ground, four pile picks to one ground pick, inserted one face one back. As shown by the section at B, the first pick is ground, the second, face, bound by the sixth end of the pattern, the third, back, bound by the fifth end. By this alternate picking of the weft to face and back of cloth, pile is produced on both sides, and as the binding of the floating material runs in straight lines, we have a cloth equally perfect on both sides, and reversible. At Figs. 249 and 250 are given different arrangements of similar

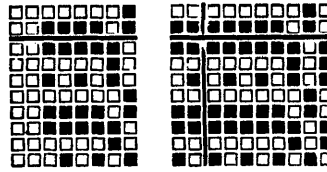

FIG. 249

FIG. 250

weaves. Both are arranged two face, two back, for the pile, with plain cloth grounds, but 250 is an example of more secure binding being given to the pile picks, thus minimising the danger of the pile being withdrawn both during, and after the cutting.

In the weaving of weft velvets, commonly called velveteens, as in the weaving of corduroys, the same principle of fabric structure is employed, but with this modification; that the binding points of the floating weft threads are so arranged, that the pile is uniformly distributed over the face of the cloth, producing a comparatively patternless fabric, having no direction of pile either one way or the other. To effect this the binding points of the pile are frequently arranged upon a satin basis, as illustrated by Figs. 251-254, four arrangements of the common eight end, and ten pick cotton velvet, having four pile to one ground pick, plain cloth backs. But upon analysis of these patterns we find that the binding points may be so arranged as to reduce the "races" by one-half, thereby reducing the labour of the cutter, and this is so, because the pile in both halves of the pattern is bound by the same warp threads, as will be apparent by the two following sections, A B, Fig. 255. A is a sectional view of pattern Fig. 251, and shows that the first four pile picks are bound by

the same warp threads that form the shed for the first ground pick, and the second four, by the same ends that are used for the second ground shed. But it also shows that there are as many "races" as there are ends in the pattern, and since the pile must be cut up the centre of the floats—as indicated by the v marks—it follows that the cutter has to make eight traverses with the knife in every repeat of the pattern. But in B, a section of Fig. 252, this is not so. All the pile is bound by the same warp threads that are used for the first ground pick, which means that there are only half the "races" in B that there are in A, as shown by the cutting marks v. But these

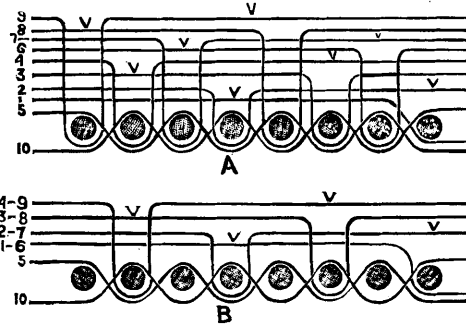
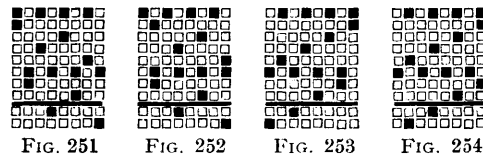

FIG. 255

sections show something else :—A shows what is practically two picks put in each shed, the intersections of the pile picks in each half of the pattern, being the same as the intersections of their respective ground picks, which means that an equal strain is put upon every warp thread used. For this reason such a design is said to be good for the weaver but bad for the cutter. In B this is not so, for we have a section which shows what is practically three picks in one shed and one pick in the other, certainly reducing the "races," but at the cost of putting unequal strain upon the warp threads—an arrangement by which the cutter is considered at the expense of the weaver.

As in corduroys, and for the very same reasons, other weaves, such as twills and satins, may be used for the grounds of such fabrics. Fig. 256 is an example with a two up and one down, three-end twill ground, having three pile picks to one ground pick, the pattern being complete on six ends and twelve picks, whilst Figs. 257 and 258 are arrangements, having eight and ten-end satins for

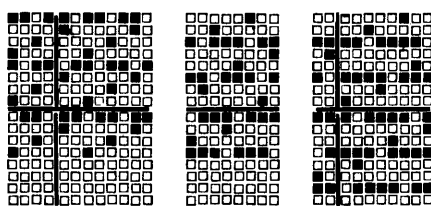

FIG. 256

FIG. 257

FIG. 258

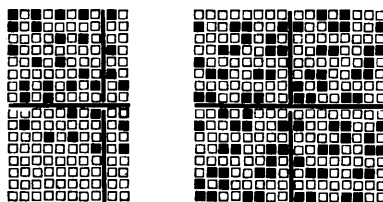
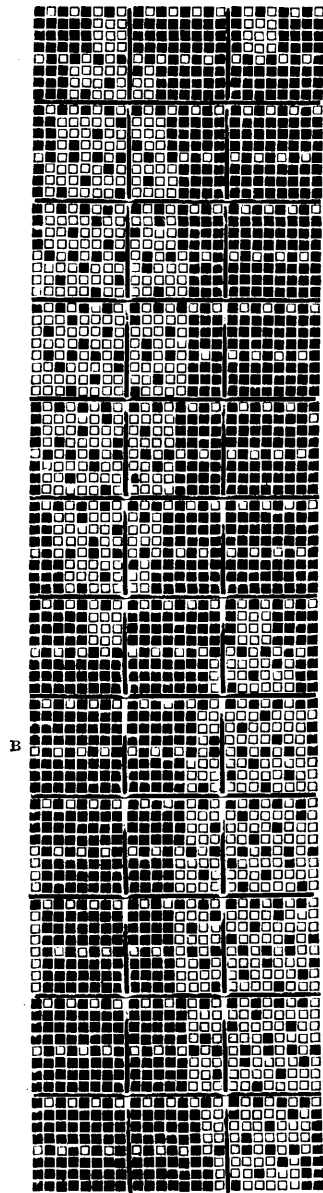
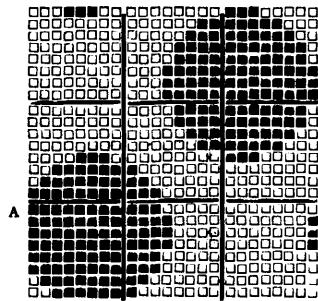

FIG. 259

FIG. 260

the pile, and four and five-end satins for the grounds, respectively. But in all these examples little security is given to the pile, as with such binding it may very easily be pulled out of the ground cloth, more particularly if the pile threads are composed of a fibre having a smooth, slippery surface. All danger of this may be obviated by causing the pile picks to make a number of intersections with the warp threads in plain order, as shown by Figs. 259 and 260. If, then, such varied bindings may be used for securing the pile material to the ground cloth, we may, by binding or not binding such material, produce any desired figure, whatever its form or outline may be, if a suitable shedding apparatus is used. For if some given portion of the pile is secured to the ground cloth and the remaining portion is not, then, by the cutting operation the unbound material will fall away, leaving nothing but that which is to produce the figure. In illustration of the method here indicated

let A, Fig. 261, be a figure motive for a design, a small spot arranged in plain cloth order on 24 ends and picks, which acts as a guide for the transference of the design to point paper, and a measure of the ultimate size of the design when worked out in full for the card cutter's use. If A represents the number of ground picks to be taken up with the design, and we determine that there shall be three pile picks to every ground pick, the whole worked out in full will



occupy 96 picks and 24 ends, as shown at B; and since A is to be represented on the face of the cloth, all pile picks not producing figure are thrown to the back as waste material. Having transferred the design to point paper, the binding of the figure is proceeded with, some arrangement of an eight satin being generally used for this purpose. This example is bound with a five-end satin, as it is a very small figure. But here we are met with a difficulty

FIG. 261

not easily overcome. The edges of the figure present unequal "races" to the cutter, some being so small that the knife would refuse to enter them. This is partly overcome by casting out all floats of less than a given number of ends, say three in such an example as the one given, whilst again, the figure may be arranged in steps of two, all short floats thrown out, and the binding points so distributed that only full "races" obtain over all. The disposal of the non-figuring material thrown to the back of the cloth is a consideration which has exercised the minds of designers. In small designs this is not a matter of much moment, as it will readily drop away in the cutting process; but in larger figures it needs holding to the ground fabric whilst the piece is being woven. In this case it is sometimes interwoven with the ground cloth in some loose manner, so that when the figure is cut it is readily brushed away: whilst occasionally an extra warp is used, which interweaves only with the waste material, so that when the figure has been cut it may be drawn away in a sheet.

Such fabrics are more suitable for ornamental than for useful purposes, for however rich and fine the figure may be, the ground cloth must necessarily have from its construction an open and somewhat poor appearance.

We now come to a consideration of that division of pile fabrics, where warp threads are used instead of weft, for the production of the pile, which, protruding from the body of the ground cloth, forms loops upon its surface. But these loops may owe their formation to (A) a quantity of warp flushed forward negatively as picks of weft are beaten up to the fell of the cloth; or (B) by the insertion of wires as picks of weft, the diameter of the wire deciding the size of the loops. Of the first, terry-towelings, and cloths built by the same weaves, are the most familiar examples; whilst the second may be represented by velvets, plushes, Brussels, and other carpeting.

Beginning with terry-towelling, as the simplest form of looped pile work, we have the loom mounted with two warps, one acting as a ground, the other as a pile warp. The ground warp is tightly weighted, the pile warp simply restrained from giving off the yarn too freely, both sets of ends being drafted in a set of four staves of

healds in skip-shaft order, end-and-end, the pile being drafted on the two front, the ground on the two back staves of healds. The picks of weft are inserted in threes or fives, and are then beaten up to the fell of the cloth, sliding along the tightly-weighted ground threads and carrying with them the lightly-weighted pile threads, which then form loops upon the face or the under side of the cloth, this being decided by having the pile ends over or under the beating-up pick and its successor. In explanation of this general statement let A, Fig. 262, be one complete draft of the pattern, B one complete repeat of the tie-up. In A the first and second staves contain the pile warp, the third and fourth the ground warp. In B we

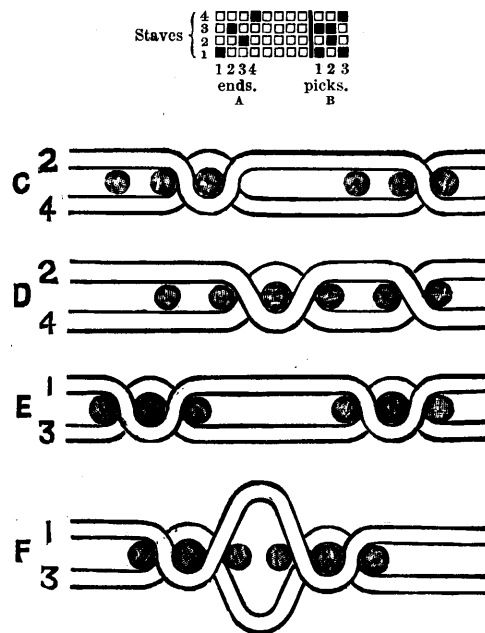

FIG. 262

have, for the first pick, the first and third staves lifted; for the second pick, the second and third staves; and for the third, the first and fourth. Building in section the fabric which would be produced by the use of such a draft and tie-up, we have C D E F—C D being sections of the ground, and E F of pile, before and after

the picks of weft are beaten up together. The relationship of the two sets of warp threads to the picks will be readily seen from these sections. *C E* shows the warp threads carried over an intervening space between the third and fourth picks—this is on the completion of the pattern, but before the beat-up; *D* shows the section of the ground cloth; and *F* the relationship of the pile ends to the picks of weft, after the beat-up. Such a cloth as this is known as a three-pick terry. It will be inferred from this, however, that some special arrangements for beating-up must obtain to produce the pile in such a manner as is here shown; and this is so. There are several arrangements which allow the reed to swivel—to be unlocked—for two picks, thus leaving those picks a given distance from the fell of the cloth, but on the third pick it is made secure—locked fast—and all three picks are beaten up together. In another we have the ground warp and cloth coming over vibrating front and back rests, which are moved forward for two, and back for the third pick, thus presenting the fell of the cloth to the forward stroke of the lay. A third arrangement causes the lay to make two short and one full stroke, whilst many manufacturers of these goods have their own special terrying arrangements.

It needs very little variation in the tie-up already given to produce, as one may desire, terry on one side of the cloth only—on the face or on the back, as the case may be. If we again use the same draft *A*, Fig. 263, but substitute the tie-up *B*, we shall have all the pile on



FIG. 263



FIG. 264

the face of the cloth because every pile end is lifted as previously indicated; or, again, using this draft *A*, Fig. 264, and the tie-up *B*, all the pile will be on the under side of the cloth, because all pile ends are down on the beating-up and succeeding pick. It follows from this that we may combine these two workings together in such a manner that figure can be produced upon the face of the cloth, which in stave work must necessarily be of some simple form, whilst the employment of a Jacquard can give any figure it is desired to

produce. In illustration of this let Fig. 265 be six staves of healds spaced to meet the requirements. Let one and two be occupied with a given number of pile ends (say eight), whilst three and four are occupied with a similar number; then, one and two may produce pile on both or on one side only; so may three and four; so that if

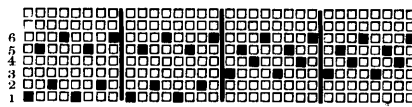

FIG. 265

one and two are bringing the pile to the face whilst three and four are carrying it to the back, a stripe of pile and one of ground is presented on either side of the cloth. But suppose such a weave is employed for a given number of picks, and then the terrying is reversed—that is, those staves which were bringing the pile to the face now carry it to the back, and those carrying it to the back now bring it to the face—a checkered effect of pile and ground is the result, the size of checks being dependent of course on the number of ends and picks used in a repeat of the pattern. If, then, we use a Jacquard to actuate the pile threads, any figure may be produced so long as we conform to the above method of working. The mounting would consist of any ordinary Jacquard machine tied up to any tie suitable to the character of the design to be produced; whilst a set of healds, through which the ground warp is drawn, produces the ground, and worked by a set of tappets placed conveniently under or by the side of the loom, so that the machine may be used entirely for figuring purposes, and the design upon point paper simply represents its action. In illustration of this let A, Fig. 266, be any portion of a design—say a band running in the border of a towel—the black portion to be pile on the face of the cloth. After transferring this in outline to point paper, proceed to fill in with the two workings as given for the tie-up of the pile staves in Figs. 263-4—for the face pile with 263, and for the under pile with 264, and we have B in the same figure. In the filling in of such working care must be taken to have the two patterns so arranged that they are both complete together when the beat-up takes place, whilst in the

weaving, pattern cards and tappets must be so timed to each other that their respective patterns shall be complete at the same time.

Having examined a method for the production of pile where the loops are formed negatively, we shall the more readily understand how loops may be formed upon the cloth in a positive manner, as

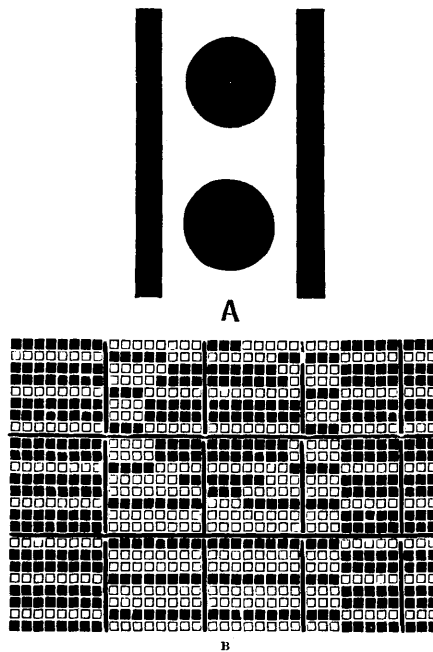

FIG. 266

instanced by such fabrics as warp velvets and plush, where, as already intimated, the loops are positively formed by the insertion of a wire, the diameter of which decides the size of the formed loop, and consequently the length of the pile. Mounting the loom with two beams, from one of which comes the pile threads, while those threads which are to form the ground come from the other, the whole may be entered into a set of healds as shown by Fig. 267, where staves 1 and 2 are used for the pile threads, and staves 3 to 6 for the ground. By this arrangement of healds and draft we can make any pattern for the ground cloth that it is possible to make

with four threads, as well as having the ready choice of lifting a half or the whole of the pile threads for the insertion of a pile wire. At A, Fig. 268, we have the point paper plan of a common velvet

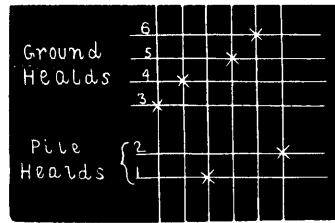

FIG. 267

having two ground to one pile end, and three pile to one ground pick, which are indicated by the solid black squares. B is the draft, and C the tie-up—the pile sheds are also shown by the asterisks—

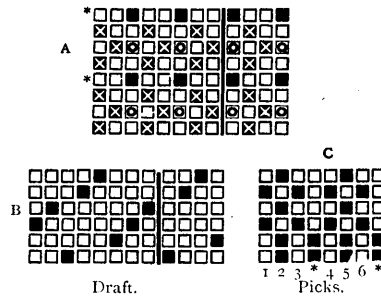

FIG. 268

all the pile being lifted for every inserted wire. If we analyse the pattern as being a typical example of this class of pile work, we find the ground ends working in plain-cloth order for one complete repeat



FIG. 269

of the pattern ; but as the same order of lifting is observed in the second repeat, we have two picks put in one shed between the finish and beginning of the two repeats, as shown in the section Fig. 269, while the pile end being intersected with the picks in

plain-cloth order—so as to secure the pile into the ground—is brought up to form a shed, between those picks put into the same shed, as the section Fig. 270 shows at A A. When these picks are beaten up therefore, the wire is forced upon the face of the cloth and the loops stand upright. But it is not always desirable that all the pile should be lifted over every wire put in, or that the ground



FIG. 270

weaves should always be based upon plain cloth. By lifting half the pile on consecutive wires a better distribution of the pile is effected, and the pile is more firmly secured into the ground; and by using a twill for the ground weave a closer and more compact

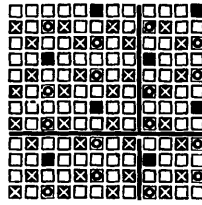

FIG. 271

fabric is got, at the same time partially hiding the intersections of the pile threads with the ground, at the back of the cloth. Of the first, the ordinary Utrecht velvet, Fig 271, is an example of the alternate lifting of pile ends on consecutive wires, and though the

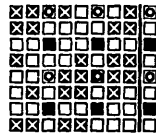

FIG. 272

ground weave is based upon a plain basis, yet two picks go into each shed, between which the pile ends are brought to the face of the cloth. In Fig. 272 is given an example of a twilled ground,

the twill used being the four up and two down, three ground to one pile pick, all the pile lifted for every wire.

This is a general statement of the methods which obtain in the building of these fabrics; but in many kinds of plush and all velvets the loops are cut, as shown by section of a velvet, Fig. 273,



FIG. 273

where the threads A B are lifted alternately over consecutive wires. The wires used for this purpose are of several kinds. In power-looms where they are inserted automatically, and have a section such as is shown at Fig. 274, those intended for cut pile having at



FIG. 274

one end a small cutter or knife A, Fig. 275. After a number of these have been inserted they are withdrawn by aid of the head B, which



FIG. 275

is seized by a hooked vibrating arm actuated by a tappet placed at the side of the loom. The non-cutting wires are without the cutting blade. In hand-loom work, where the wires are inserted by hand, they are altogether of a different character, and are not cutters and non-cutters in the sense that the power-loom wires are, as, after the insertion of a given number, the operation of cutting them out of the cloth devolves upon the weaver. To aid him in his work, one kind of wire is made of a section shown at Fig. 276, the groove in the upper surface acting as a guide for the cutting instrument; another has a section, Fig. 277, consisting of two flattened wires placed side

by side and soldered together at the ends for about an inch, leaving them free to open for the greater part of their length. A number of such wires having been inserted, the weaver begins to cut them out of the cloth in consecutive order, beginning with the first that was



FIG. 276



FIG. 277

put in, inserting the knife of the trevet A, Fig. 278, into the groove of such a wire as 276 or between the wires of 277, by which they are released.

It will be seen from what has already been said that by employing cutting and non-cutting wires, a fabric may be ornamented with a design made up of cut and uncut pile, and that the design may be

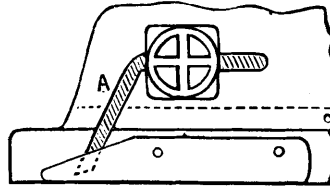

FIG. 278

anything in outline providing a suitable shedding apparatus is used—that figure or ground may be either one or the other. If a Jacquard machine, through the mounting of which the threads of the pile warp are drafted, is mounted on a loom, we may lift those threads in any order we choose, and insert a pile wire; but before any ground picks are put in the second pile wire must be inserted into a shed formed by lifting all pile threads which were left down for the first wire. If, upon the withdrawal of these, one of them cuts all the threads which have been lifted over it and the other does not, we are presented with a row of cut and uncut loops reaching across the fabric.

A fabric woven by such a method is practically one where all the pile is lifted on every pile pick, as no ground picks have been inserted between the two wire sheds—which will be more apparent

from Figs. 279-80, where A B are two pile threads taken over cutting and non-cutting wires respectively. In the first diagram we see what actually takes place when the wires have been inserted, but before the ground picks have been beaten up together ; in the second, the fourth ground pick having been beaten up to the third, it is seen

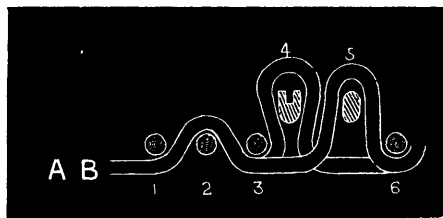

FIG. 279

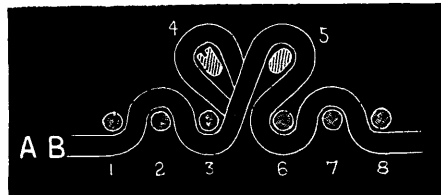

FIG. 280

that the wires are forced upon the face of the cloth, and that if one wire is cut out of its loops and the other simply withdrawn, we have loops of cut and uncut pile standing side by side.

Let Fig. 281 be any portion of a figure motive in a design for which a set of cards is to be cut, the ground to be of cut, the figure

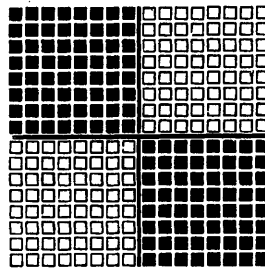

FIG. 281

of uncut pile. If the healds through which the ground threads are drawn are tied up to the machine, then their action will need

marking down the sides of the design in those bars which correspond to the spare rows of hooks used for this purpose, and it will be evident from the examples and illustrations already given that the sheds to be formed in weaving the design will be—

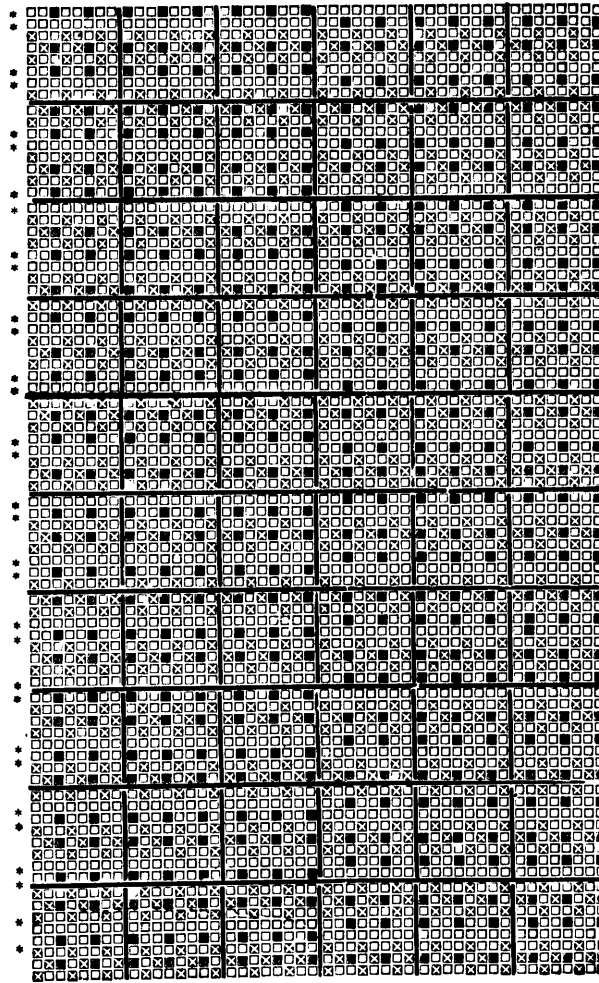

FIG. 282

1st Pick.—Number one stave lifted, number two and the pile threads left down.

2nd Pick.—Number two stave and all the pile warp lifted, number one stave left down.

3rd Pick.—Number one stave lifted, number two and the pile warp left down.

4th Pick.—Wire shed formed by lifting that portion of the pile warp which is indicated by □ Fig. 283.

5th Pick.—Wire shed formed by lifting that portion of the pile warp indicated by ■ Fig. 283.

The full working of this cannot be shown unless we work out the full card-cutting plan, as instanced by Fig. 282, where the figure motive is treated as if being actually prepared for the card cutter. In this example the asterisks indicate the pile sheds, the solid black dots the pile ends lifted for the figuring sheds, the crosses the ground ends and sheds, whilst the circles show the binding of the pile ends into the ground. But such a working implies, that part of the Jacquard mounting is taken up with working the ground threads,

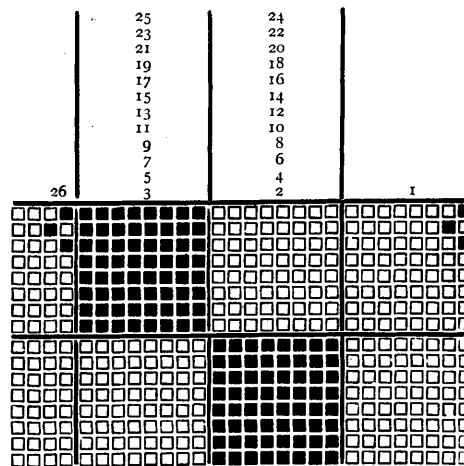

FIG 283

whereas it is entirely given over to the production of figure and the healds to the ground, so that in giving instructions to the card cutter the matter is greatly simplified, as is shown by the following :—Let the first and second hooks in the first and twenty-sixth rows of the machine be given over to the working of the healds ; let rows two

to twenty-five inclusive be given up to the figuring; then all the card cutter requires is shown at Fig. 283, along with these instructions—

1st Card.—Cut No. 1 in bars 1 and 26.

2nd Card.—Cut No. 2 in bars 1 and 26 and □, ■ bars 2 to 25.

3rd Card.—As number one.

4th Card.—Cut □ in bars 2 to 25.

5th Card.—Cut ■ in bars 2 to 25.

Cards to be laced in this order.

Such, then, is a general statement of the principle employed in producing simple, plain and figured velvet and plush. Of course it goes without saying that there are many modifications made in the actual production of such fabrics, but these only make subdivisions of one great class of woven fabrics.

One principle of manufacturing velvets and plushes which has been in use for many years is the simultaneous weaving of two textures, which strictly speaking produce a double fabric, insomuch that two distinct fabrics are woven face to face; but since they are essentially plushes, they will be dealt with in this section. The method here indicated is an economical one, and capable of giving perfect plain plushes and velvets, but does not lend itself so readily to the manufacture of figured textures.

A specially constructed loom is mounted with one or two pile beams, and a ground beam, the threads from which are drafted through a set of healds, one part of the set taking the pile, the other the ground ends. The tie-up or lifting of the ground healds is of such a character as to produce two separate and distinct cloths, which have for a base the plain weave. Whilst these are being woven, the healds containing the pile threads carry them at regularly recurring intervals from bottom to top, and from top to bottom cloths, without stitching them closely together; so that we have two cloths standing some distance away from each other, the intervening space being occupied by threads passing from one to the other. Close by the breast-beam of the loom, a plate is fixed upon which a holder containing a cutter or knife, slides at given intervals from side to side of the loom; so that, as two strongly-spiked rollers, one placed above, the other below the plate,

take forward the cloth as woven, the pile threads which pass from cloth to cloth are presented to the cutter, and are severed by the lateral movement given to it by a tappet placed at the side of the loom.

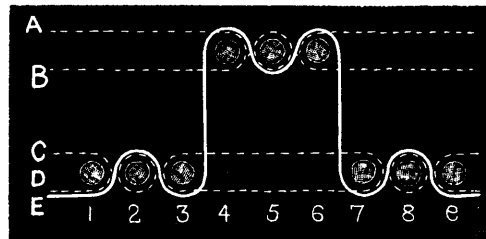

FIG. 284

By the example given students will readily understand the nature of the work done in producing such fabrics. Fig. 284 is a section of double plush; A B are the ground ends forming the top cloth; C D the ends forming the bottom cloth; E is a pile end which, after being secured into the lower cloth, is carried to the upper one, and is there again secured by being interwoven in plain order. Picks 1, 2, 3, 4, 5, 6 intersect in plain order with their respective warps. But if reference is made to Figs. 269 and 270 it will be seen that the structure there employed in the build of single plush is also observed here in the build of a double one, the ground fabrics being the same, and when the picks are beaten together the pile issues from each cloth between two picks put into the same shed.

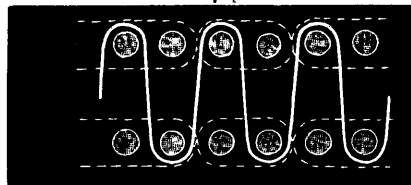

FIG. 285

The method of interweaving the several sets of threads is, if we may be allowed the expression, a foundation weave from which others of a more intricate nature are derived. In some the ground weaves are different, in others two sets of pile threads are

used in such a manner that as one set is being carried from the top to the bottom cloth, the other set is being taken from bottom to top. At Figs. 285-289 are given a few sections made from several varieties of these double plushes, from which students may readily make the point-paper pattern, draft, and tie-up.

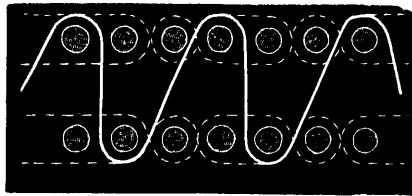

FIG. 286

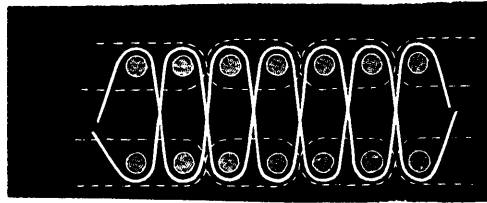

FIG. 287

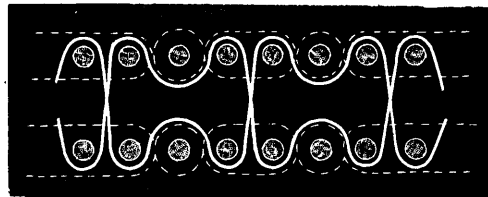

FIG. 288

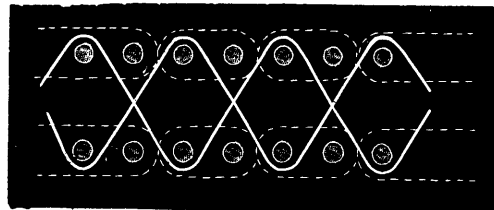

FIG. 289

Tapestry carpets are true pile fabrics—the surface being looped but not cut—and are based upon a plan which is but a slight modification of the single plush weaves already referred to, the

modification consisting of the addition of an extra warp, which acts as wadding to the body of the cloth, giving to it increased strength and thickness. This is demanded by the use to which the fabric is to be put, which also requires the yarns to be of a character to withstand considerable wear and tear. The construction of this fabric will be readily understood by referring to the section Fig. 290,

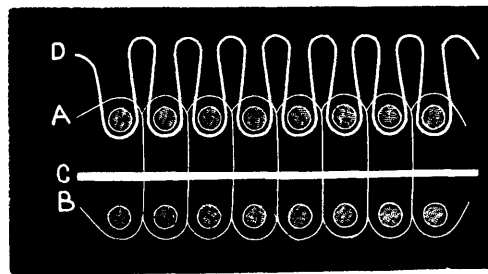

FIG. 290

where A B are threads of a ground warp ; c, an end of wadding ; D, a pile end. The whole are dented four ends in a dent ; two ground, one wadding, one pile in every dent ; all the pile lifted for every wire inserted. The point paper plan of the pattern, along with its draft, are shown at A B, Fig. 291, an analysis of which shows that only four

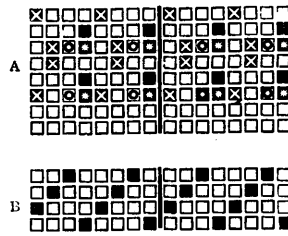

FIG. 291

staves of healds are required for weaving this fabric. But, from examples easily obtained it will be found that these fabrics are ornamented simply by a colour effect obtained by printing the threads which are to form the pile—not a pattern produced by cutting or not cutting the loops, or by making pile or no pile with variously dyed threads brought to the face of the cloth for that purpose, as will be evident when we remember that all the pile threads are drafted through one stave of healds, which, in itself, has

no capacity for producing pattern. The printing of the pile warp is performed previous to the weaving operation and may be explained thus:—The general width of these fabrics is 27in., in which there are 216 pile threads. These threads are printed according to the design, whilst wound upon a large drum, the length of any given colour for each thread being regulated by the diameter of the wires to be used and the number of consecutive loops to be made of that colour, due regard being also given to the amount of contraction which is inevitable in weaving. Such conditions having been determined, A, Fig. 292, may represent any one of the printed threads taken from



FIG. 292

the pile warp, the alternate white and shaded spaces representing any two colours used. If this thread is formed into loops by such a weave as that employed at Fig. 290, we have B, which presents on the face of the cloth an alternation of coloured loops forming part of any given design. The designs for this class of fabric are painted up in solid colour on paper ruled 8×8 or 8×7 to the bar, the ruling being of a size equal to the size of the design on the face of the cloth, which means that the design paper is 27in. wide, divided into 27 bars, 8 ends to the bar. Any number of colours may be used in these designs. But this method of producing a design by printing it upon the warp gives rise to a serious defect in the appearance of a pattern—viz., the want of definiteness in its outline. This always arises from the fact that the unequal contraction of the warp pile threads in weaving does not allow consecutive warp threads of the same colour to present themselves to the fell of the cloth at exactly the same time, one thread being slightly in advance or behind its neighbour; hence we have a mistiness of outline in

tapestry carpet designs, and all printed warp effects, not found in any other class of pile fabrics. But in the build of such a cloth as this, we have the elements of a more advanced structure in fabrics, as represented by such as Brussels carpeting, which offer the widest possible scope to the ingenuity of designer and manufacturer. We have seen how the ground cloth is built up; how strength and thickness are obtained by the use of a set of wadding threads; how the pile is formed upon the face of the cloth; and how design is produced by the use of colour, all of which obtain, with the exception of the latter, in the construction of Brussels carpets. Here the design does not depend on bringing to the surface threads which have been printed according to the design, but by lifting to the face of the fabric dyed threads which are self-coloured throughout their entire length, no thread being of more than one colour. For this purpose the loom is fitted with creels or "frames" in lieu of pile beams, each frame being devoted to one colour, and having a capacity of 256 bobbins; so that the terms 3 frame, 4 frame, and 5 frame, simply indicate the number of pile threads used in the construction of the fabric, in addition to which there is a ground beam, and in some cases a wadding beam. These several kinds of ends are taken forward and drafted, the ground into a set of healds, the pile into the mounting of a Jacquard, and the whole drawn into the reed. But the denting is decided by the number of colours used in the pile warps. If we have a five "frame" arrangement of colours, then each dent will contain five threads of pile, one of each colour, and two ground ends; if a three "frame," three pile ends and two ground ones: so that in each dent of the reed we have seven ends for a five "frame" and five ends for a three "frame." In weaving, for every wire inserted a row of loops must be formed across the cloth; this row is made up of 256 ends, which may be of any of the colours used; and the remaining pile threads not called up to produce pattern are lying in the body of the cloth, acting as wadding ends. This is made more apparent by the following section of a three "frame" fabric, Fig. 293, where A B C are pile ends, and D E ground ends; the pile ends of any given colour passing into the body of the fabric after having made their portion of the design, which means that the quality of

the fabric largely depends upon the number of "frames" used. And this must be so if it is remembered that in a three "frame" carpet there are 768 pile ends, in a four "frame" 1,024, in a five "frame" 1,280, and that only 256 out of any of these numbers can be brought to the face of the fabric for the insertion of any wire; so that, in the three "frame" there are always 512 ends lying in the body of the fabric, in the four "frame" 768 ends, and in the five "frame" 1,024 ends, all acting as wadding to their respective cloths. There

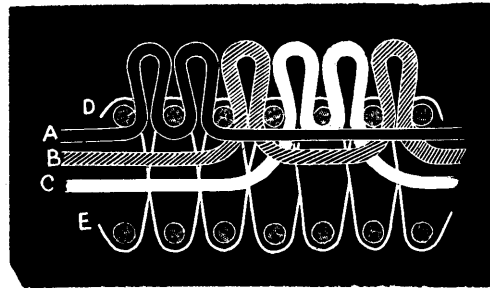

FIG. 293

is one thing we wish to draw attention to at this point, and that is—that the contraction or take-up of the pile threads is a very variable quantity. According to the requirements of the design, a thread of any given colour may be brought to the surface of the cloth on any number of consecutive wires, or, on the other hand, such a thread may lie in the body of the cloth, whilst an almost indefinite number of picks have been inserted. Owing to this variable pacing of the pile threads an ordinary beam cannot be used, but each thread is wound upon a separate bobbin and weighted as it stands in the creel or frame.

One system of weighting the bobbins used in figured pile weaving is illustrated by Fig. 294, where A is the body of the bobbin upon which the yarn is wound; B, a grooved neck, round which a cord is taken several times, supporting the weight C. As the yarn is drawn forward from the bobbin by the process of weaving, the cord is wound up until the weight falls over and regains its original position, as shown by the sketch. One advantage of this method of weighting

is that it admits of a rolling give-and-take movement of the bobbin, as required by the formation of the various sheds.

Since pattern in this class of fabrics depends on colour, the designs are painted up in those colours it is desired to bring to the face of the fabric, and are prepared on design paper ruled square, 8×8 or 10×10 to the bar, as the number of loops to be made per inch in both directions is equal. As the finished

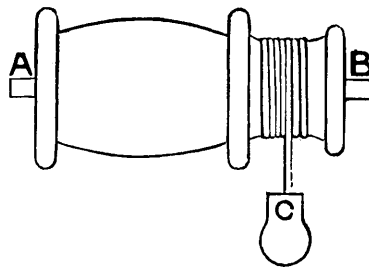

FIG. 294

design on 256 ends may represent 3, 4, or 5 times that number of pile ends, any one of which may be brought to the face for figuring purposes, it follows that such a design does not actually show what takes place in the weaving. Taking the simplest possible example for the purpose of illustrating this, let A, Fig. 295, be any portion of a design for a three "frame" fabric, the different markings representing the three several colours to be used. Though eight threads are only apparent on the face, the whole represents twenty-four figuring ends, and since there are two ground ends to every three figuring ends, the whole design will occupy forty ends if worked out fully, as shown at B. Arranging the ends by the indicating bar c, proceed to put the design on the ends corresponding to the colour wanted on each pile shed, after which the stitching of pile ends into the ground is attended to, shown by the marks, thus —. The asterisks indicate the pile sheds, and the bracketing together of the ends the denting, which principle may be followed in working up all designs for similar fabrics. But it will be apparent from what has been said that in working out the

full card-cutting plan only the figuring ends need be dealt with, as the ground ends are worked by healds and tappets, and not by the Jacquard machine; and that the size of the machine will depend upon the number of figuring ends. Thus, for a three "frame" 768

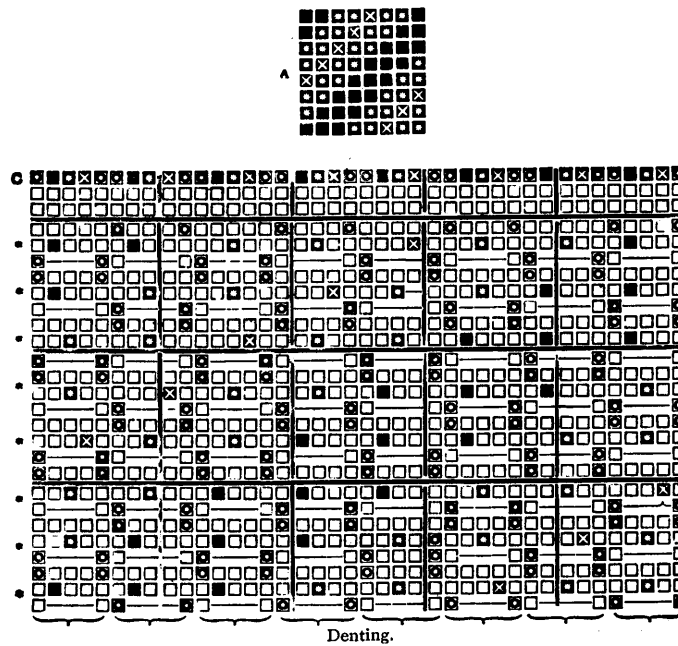

FIG. 295

needles will be required, for a four "frame" 1,024 needles, and for a five "frame" 1,280 needles. The machine used is generally that known as the "cord" machine of William Jennings, which may be tied up in the manner of an ordinary brocade mounting with a straight tie, or as a divided machine, where a given portion is tied up so as to work its own colour.

There are other fabrics made upon the principle here shown, such as plushes where detached figures of either cut or uncut pile stand out and upon satin or repp grounds, and Wilton carpets, which are really Brussels with all the pile loops cut.

Another so-called pile fabric is one produced from chenille, but it has not the structure of true pile, being only an imitation of pile depending for its ornament upon a peculiar use of coloured weft threads.

CHAPTER XIII

BACKED AND DOUBLE CLOTH

IN double-cloth making we are brought face to face with so great a variety of fabrics, that we shall simply content ourselves with noticing the principles underlying their structure and the methods employed for their ornamentation, giving examples of those varieties which seem to be representative of a class. Strictly speaking, a double cloth must be absolutely two fabrics, either separate and distinct from each other, or so stitched or interwoven with one another that they form one solid and compact fabric, as instanced by the weaving of a bag or tube on the one hand, and a three or four-ply cloth on the other. In one division of the series of fabrics belonging to double-cloth weaving, we have all those intricate and complicated weaves where warp and weft threads are multiplied either as to colour or material, each kind or colour interweaving with its weft or warp and contributing to the full expression of a complete design, as instanced by many varieties of tapestry cloths. Double-cloth making may be said to begin with backed fabrics, which are increased in weight and thickness by the addition of weft or warp threads, thrown to the back of the cloth, so as to act as a lining or backing to the face fabric. These threads may be altogether different in character to those used for the face. They may be of different colour, or count, or material; the structure of the fabric being such that these peculiarities are not seen on the face of the cloth, though the face may be of relatively fine material when compared to that used for the back.

Let A, Fig. 296, be a pattern to be arranged as a weft-backed fabric, (A) pick and pick, and (B) in the proportion of two face to

one back, which means that the number of face to back picks must be for A as one is to one, and for B as two is to one. Proceeding to arrange the pattern A on the alternate picks of the new design,

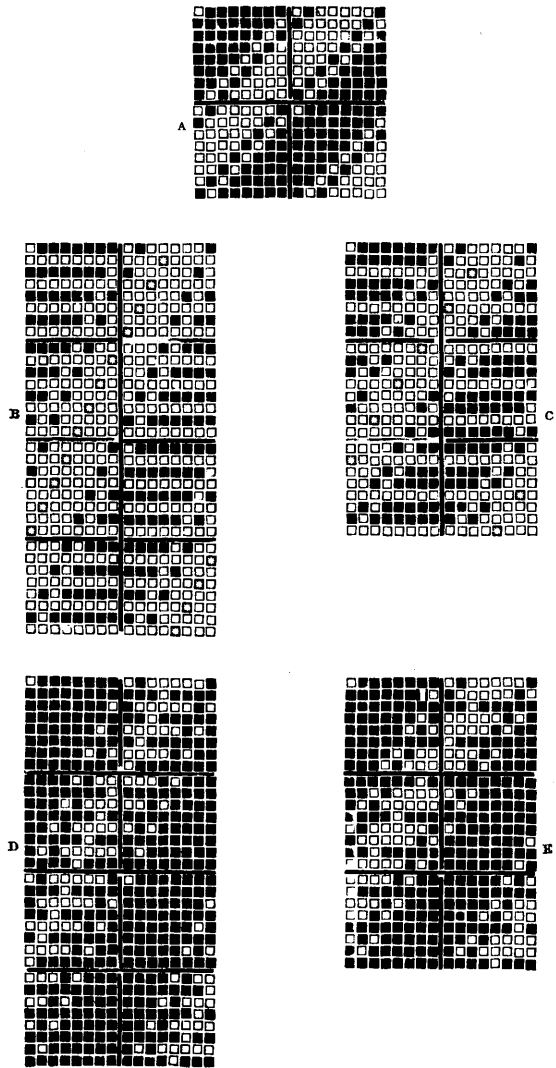

FIG. 296

we have *B*, and in a similar manner *c* for the second arrangement. Having arranged the face pattern, the back picks and the manner in which they are to be bound to the face cloth must now be considered, for upon the proper selection of these binding points depends the perfection of the whole fabric, since the appearance of this backing material on the face would destroy the character of the design. But this cannot happen if the binding for the back picks is made at a point where two face picks are floated, one on each side of such a binding point, as indicated by the small stars in *B c*, because the face picks flushing loosely at these points over the warp threads will spread out and hide whatever is beneath them. Having selected the binding points, proceed to throw the picks to the back of the cloth by lifting up all threads not required for the binding, and the patterns are complete, as shown at *D E*. That such a selection of binding points gives what is desired may be seen on reference to Fig. 297, a section made from the first two and the last

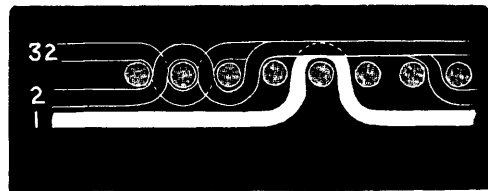

FIG. 297

pick of *D*, that marked *1* being the back pick, *2* and *32* face picks which come together on the repetition of the pattern. In all regular patterns, *i.e.*, those which move to the right or left by a regular succession of stepping, the binding points are easy of arrangement, as in the generality of cases they may follow the direction of the face pattern, but in all irregular patterns the binding points for the back picks must be placed where they can best be covered by the face picks.

In a second division of this class of fabrics, warp threads are used for backing purposes, face ends and back ends bearing the same relationship to each other as did the picks in the last examples, and may be used in like proportions. Mounting the loom with two warp beams, one for face, the other for backing warp, the threads

are taken forward and drafted into the healds, each series having its own set. The denting is, of course, decided by the proportion of face to back; if two to one, the back end must be so drafted as to stand in the middle of the dent, which is a position of advantage, as the binding points are more easily hidden than if such ends were drawn next to the metal of the reed.

In illustration of the method which must be used in binding the backing warp to face cloth, let A, Fig. 298, be a pattern to be backed

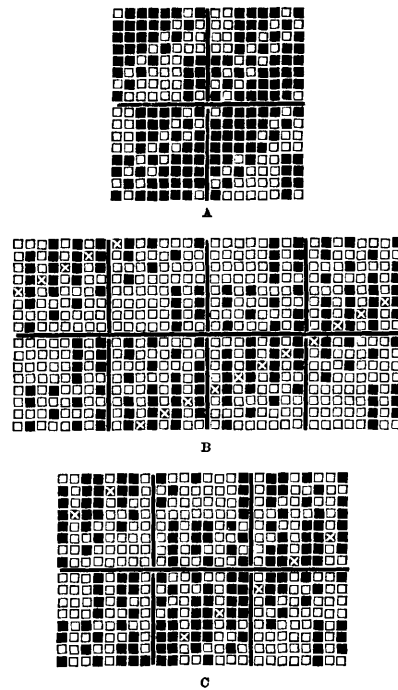

FIG. 298

with warp, B, in the proportion of one face one back, and C, in the proportion of two face one back. As the first is to be end and end, the face pattern A is to be put on the alternate ends of the new pattern, as shown at B; whilst the second, being in the proportion of two face to one back, must have the back pattern put upon every third end, the arrangement beginning with one face end, as shown at C, as this helps the denting. Since the backing in this case is

made from warp, the binding points must be selected so as to rise between floating warp threads of the face pattern, as indicated by the crosses in B, C, these points of attachment being hidden by the loosely floating ends of the face warp. In all patterns the position of the binding points will be decided by the face pattern.

The loosely floating back material of these cloths is often raised so as to produce a soft, woolly underside, when the fabrics are intended for clothing purposes.

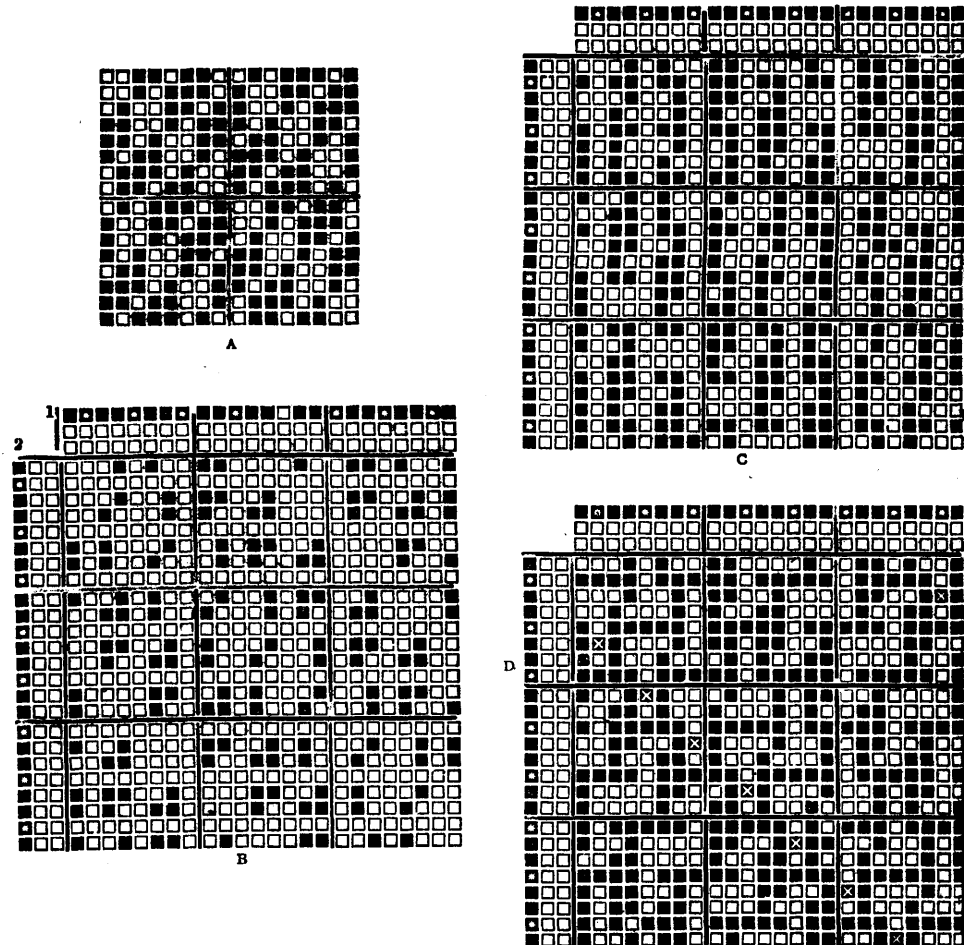

FIG. 299

But this backing of a fabric may be carried a step further, for if we can combine the two previous workings together, there is no reason why we may not attach to the face fabric a second one that shall act as a perfect lining, which may be of any colour or colours or material, each cloth being of any pattern and perfect in itself. It is only necessary, in building a fabric where these features obtain, to so secure the two together that the perfectness of the face cloth is not injured, and that no indications of a second cloth appear on the face. Let A, Fig. 299, be the figure motive for the face cloth, to be got up as an extra weft and warp backed fabric in the proportion of two face ends to one back end, and two face picks to one back pick, the back to be plain cloth. Proceeding to work this example, first indicate by such lines as 1, 2, which are face ends and picks and back ends and picks, and proceed to put the given pattern A on the face ends and picks, which gives the result as shown at B; then, since all face ends must be lifted when a back pick is put in—or the two would be interwoven—lift all face ends on every back pick, which gives C, and proceed to put plain cloth on the back ends and picks, as shown by D. As far as the two cloths are concerned, this is all that is needed, but since the back has to act as a lining to the face cloth, the two must be secured together by stitching; so that, as the last part of the work for completing the design, lift a back end when a face pick is inserted, but in such a place as shall have on the one side and the other floating ends of the face material. This stitching of the two cloths is indicated by the crosses in D, an arrangement showing a regular eight-end twill binding running in the opposite direction to the face pattern.

The example last given contains all the elements of double cloth making. Warp and weft threads are divided into two series, each producing its own fabric, which, by a proper arrangement of materials, may be anything in character. It follows that, if we have suitable shedding and shuttling apparatus, we may still further increase the series in the two sets of threads, and thereby produce what we may call compound fabrics—fabrics compounded together to produce any given fabric, each component part of which may be like or unlike in structure, ornamentation, or material.

Beginning with the most elementary weave, let us first examine the structure of such fabrics as tubes and other circular makes. At A B C, Fig. 300, we have the progression of weaves required

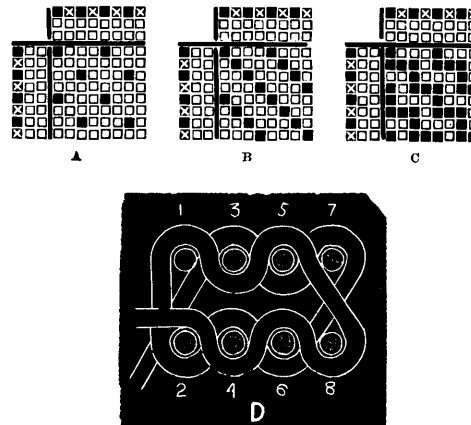

FIG. 300

in such fabrics, A shows plain cloth put upon face ends and face picks; B, plain cloth put on both face and back ends and picks; C, all face ends lifted on back picks, so that they may not interweave with the face, and by so doing stitch the two together. The indicating lines put athwart the ends and picks distinguish face ends and picks from back ends and picks. That such a manipulation of warp and weft threads gives the desired result will be apparent by the section D, representing the first four picks of C, which have been inserted in the following order:—1st pick, all face ends, 1, 3, 5, 7, and back ends, 4, 8, lifted; 2nd pick, all back ends, 2, 4, 6, 8, down, and face ends, 3, 7, lifted; 3rd pick, all face ends, 1, 3, 5, 7, and back ends, 2, 6, lifted; 4th pick, all back ends, 2, 4, 6, 8, down, and face ends, 1, 5, lifted.

As only one shuttle is here used, and the thread from it, is carried alternately from the bottom portion to the top portion, and *vice versa*, a perfect tube is produced. But if two shuttles had been used, each weaving with its own cloth, no connection would have taken place, and the upper and lower fabrics would have come out of the loom free from each other. The result will be quite

different, however, if, still using one shuttle, the picking is arranged two face, two back. Taking the same number of ends and picks as in the last example, let A B C, Fig. 301, show the progression of the weave, and the indicating lines, the arrangement of warp and weft

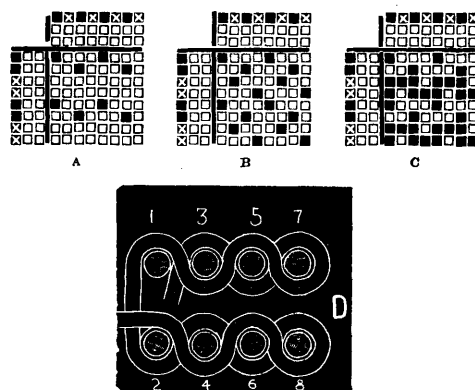

FIG. 301

threads. Analysing the first four picks of c, we have D, a cloth free to open out to double the width when taken from the loom. Weaving three, four, or more ply cloths is simply multiplying the number of the above fabrics, except that they all need stitching together so as to form one solid and compact cloth. To show the method of stitching such cloths together Fig. 302 is given—the weave for a four ply plain cloth, the various markings in the indicating bars representing the different series of warp and weft threads which go to form the several cloths. A shows the plain working put on the ends and picks for each cloth, B the lifting of the several warps so as to get the picks into their respective positions. As yet they are not stitched together, but this may be effected by one of two ways. An end of one cloth may be lifted into that immediately above it, or an end of an upper may be sunk into a lower cloth. The first of these methods is shown at c and by the section D, in which we have an end of the second lifted when a pick is put into the top cloth; an end of the third lifted when a pick is put into the second cloth; and an end of the fourth lifted into the third cloth; by which all four are securely fastened together.

In stitching plain cloths together, whether of two or more ply, the stitching points can never be perfectly hidden, on account of the alternate interlacing of the two sets of threads; but if twill

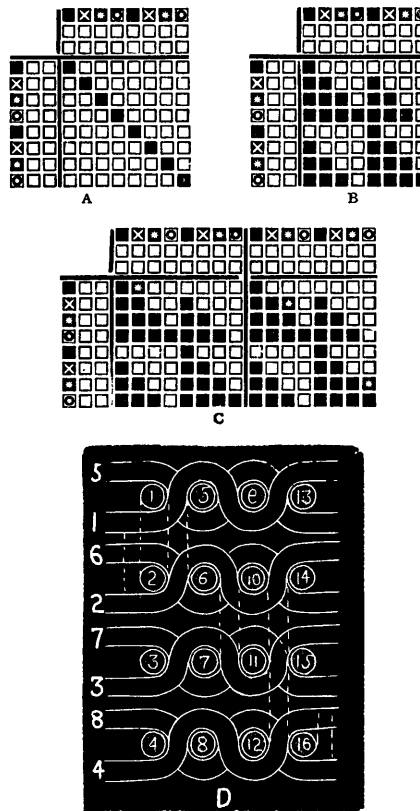

FIG. 302

weaves are used, this may be satisfactorily arranged, as shown by Fig. 303, where A shows four-end twill on face ends and picks; B, four-end twill on back ends and picks; C, four-end twill on both back and face ends and picks, the crosses indicating the stitching points of the two cloths. It will be noticed in this example that the two twills run in opposite directions to each other—an arrangement which makes the cloth perfectly reversible as regards direction of pattern.

But this stitching may be made to serve other purposes than the mere fastening together of two cloths. It may not only fasten, but create whatever of pattern the fabric possesses, and so produce a fabric that has a more or less embossed effect.

Piqués are cloths in which such conditions of build obtain, and are characterised in their simpler forms by a pattern of alternate ribs and hollows running across the piece, the face of the

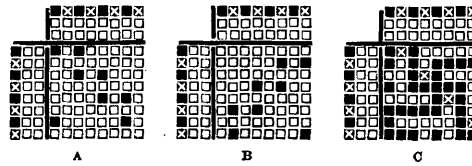

FIG. 303

cloth being perfectly plain. The build of these cloths may assume any of three forms:—(1) Face cloth with back ends used for stitching purposes and one weft; (2) face cloth with back ends and two wefts, one of a coarse character, which acts as a wadding weft for increasing the rib; or, (3) face cloth with back ends and two wefts, one of which is used for wadding as well as for backing by interweaving with the stitching ends.

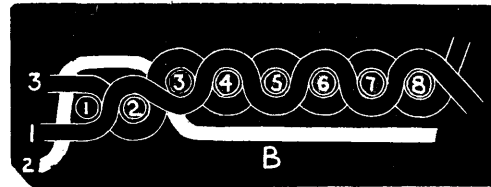
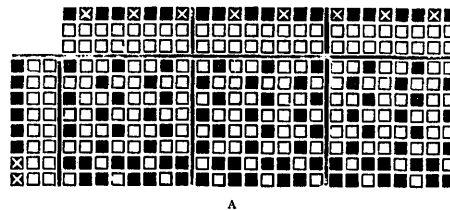

FIG. 304

A, Fig. 304, is an example of the first of these, arranged two face ends to one back end, and six face picks to two stitching picks. By

examining the section B, made from the first three threads of A, we shall the better understand what takes place. Warp threads 1, 3 are making continuous plain cloth, whilst the stitching end 2 is floating on the back for six consecutive picks, and then raised into the face for two picks. But since these two sets of threads come from separate beams, and are differently weighted, the back ends more tightly than the face, the fact of carrying such threads into the face, pulls down that cloth at these places, and so produces the hollow; and since all back threads are lifted at the same time, these hollows run across the piece. It is this variable weighting of the two sets of threads that gives the embossed effect on the face, the tighter the back threads are the more pronounced this is. Another form of this is shown at Fig. 305, where the face cloth ceases to be made on the stitching pick. From this it

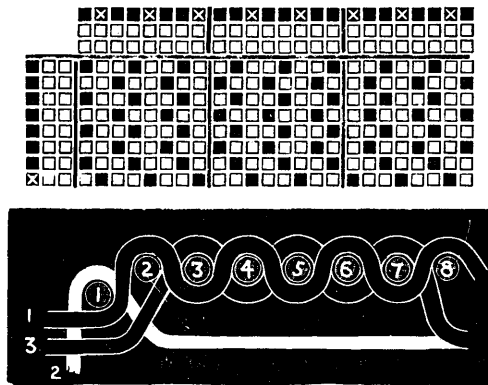
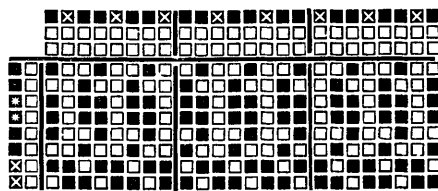

FIG. 305

will be seen that the character of the cutting may be varied, as a one or two-pick stitch, these numbers indicating on how many consecutive picks the stitching ends are taken into the face cloth.

Fig. 306 is an illustration of the second variety of these cloths. Wadding picks, which do not interweave with either set of warp threads, but simply lie between the two, are used. They are of coarse weft, and by their use, help to make the rib more round than would otherwise be the case. A is the pattern, arranged in the

warp, two face one back ; whilst the picks are put in two face two wadding, two face two stitching, B being a section of the first three



A

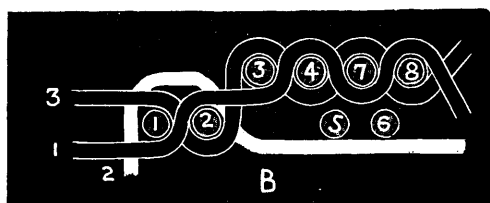
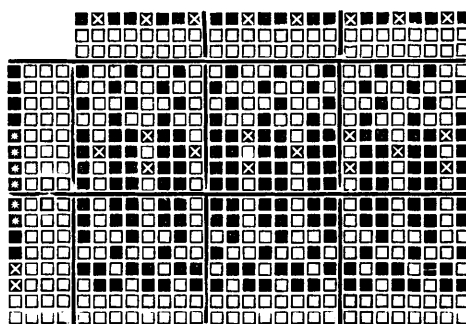

FIG. 306



A

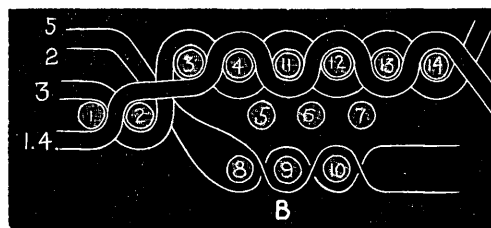

FIG 307

ends of the pattern.

The third variety is illustrated by Fig. 307, an example showing

both wadding and back picks. The warp is arranged as in the last example, the picks being inserted in the proportion of six face, three wadding, three back, two stitching, in the manner shown by the indicating line for the picking. The section B shows picks 5, 6, 7, 8, 9, 10 standing immediately over each other, and that they have been put in consecutively. The reason for this is: we have assumed that a single box loom has been used, by which a single pick of any given weft could not be inserted either in face, wadding, or back; and it does not really matter at what part of the repeat of the pattern the wadding picks are inserted, for since they do not intersect with any warp threads they will be forced into their position in the middle of the rib by the pressure of the face and back weaves.

It will be evident from these examples that, since pattern is the result of stitching, we have only to modify the stitching to produce any desired figured effect, and that by employing a dobbie or Jacquard to operate the stitching ends, the figure may have any form of outline, as instanced by such fabrics as toiletings and quilts. In A, Fig. 308, we have a draft on eight staves of healds. The four

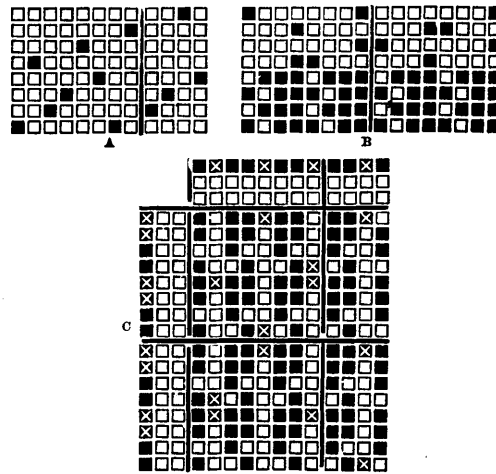

FIG. 308

front ones are for the plain cloth, the four back ones for the stitching ends, the whole drawn two face one back, three ends in a dent. B is the tie-up, from which we have these particulars of picking:—

1, 2, 5, 6, 9, 10, 13, 14 face picks ; 3, 7, 11, 15 wadding picks ; 4, 8, 12, 16 back picks, making plain cloth with the back ends ; but we also see that the 1, 5, 9, and 13 picks are the stitching picks, a back end being lifted over a face pick, and that these stitchings are made by lifting the back ends consecutively. From this we have a diagonal rib of pattern running up and across the cloth ; but if the tie-up had been produced to double the length, the last half lifting in reverse order to the first, a waved effect would have been

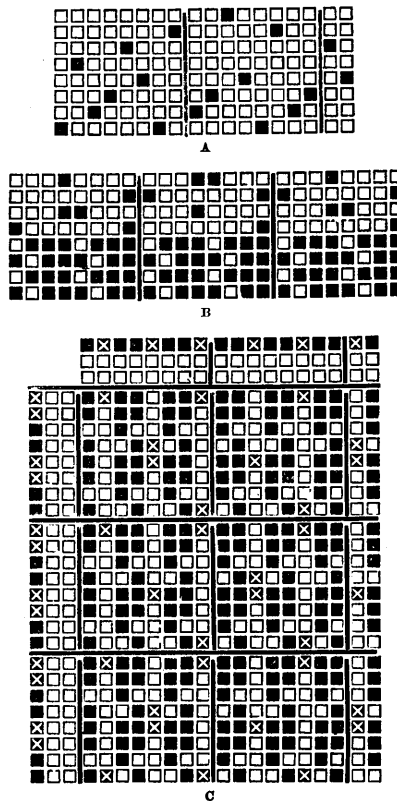
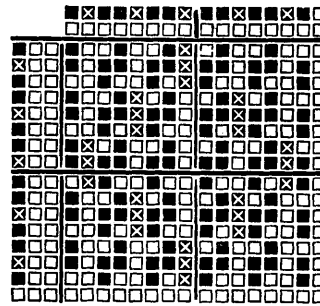

FIG. 309

produced running lengthwise of the fabric. Diamond effects are produced by using a centred draft for the stitching healds, such as Fig. 309, where A is the draft, B the tie-up, and C the point paper

pattern produced from A and B. Such are the simple pattern effects which may be produced by healds, though by altering the drafts of the stitching warps complicated and extensive patterns may be got, just as in any other kind of figured stave work, limited, of course, to geometrical and line effects. If a Jacquard machine is employed as a shedding motion for the figure-producing warp, there is no limit to the possibilities of pattern effects, any more than in any other branch of figure weaving. But if we use such a machine for producing a cloth of this character, the first consideration must be, how can it be mounted and used so as to effect the greatest economy in time and material? time as regards the designer, material as regards the quantity of



A

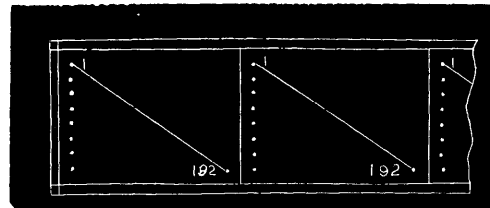

B

FIG. 310

cards required, because, by employing certain forms of mounting, a positive waste takes place in both these items. To illustrate what is meant, let A, Fig. 310, be the design, to be woven by a Jacquard tied up to the plan B, an ordinary straight or lay-over tie.

The two warps would be drafted through the harness just as they are placed in the pattern, in the proportion of two face one back;

so that two-thirds of the machine is taken up with face ends, the remaining third with back or figuring ends. Now if this means anything at all, it is that two-thirds of the machine are being used for producing plain cloth; that the figuring capacity of the machine has been reduced to one-third its number of hooks; that whatever kind of shed has to be formed, whether face, wadding, or back, a pattern card is required for every shed made, and the machine has to form that shed. It also means that whatever may be the size of the design, the whole must be painted up in full on design paper for the use of the card cutter. But much of this is changed if the mounting is modified by placing a set of healds in front of it similar to Fig. 311, and draft the face ends into the healds and the

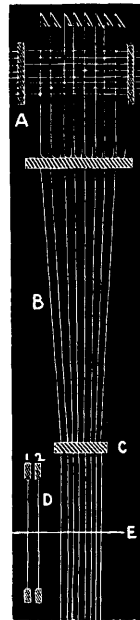

FIG. 311

figuring threads into the Jacquard mounting, because each set of warp threads is governed by its own shedding apparatus, the healds by tappets, the Jacquard by a machine lift. By this arrangement of parts, the sheds to be formed may be made as

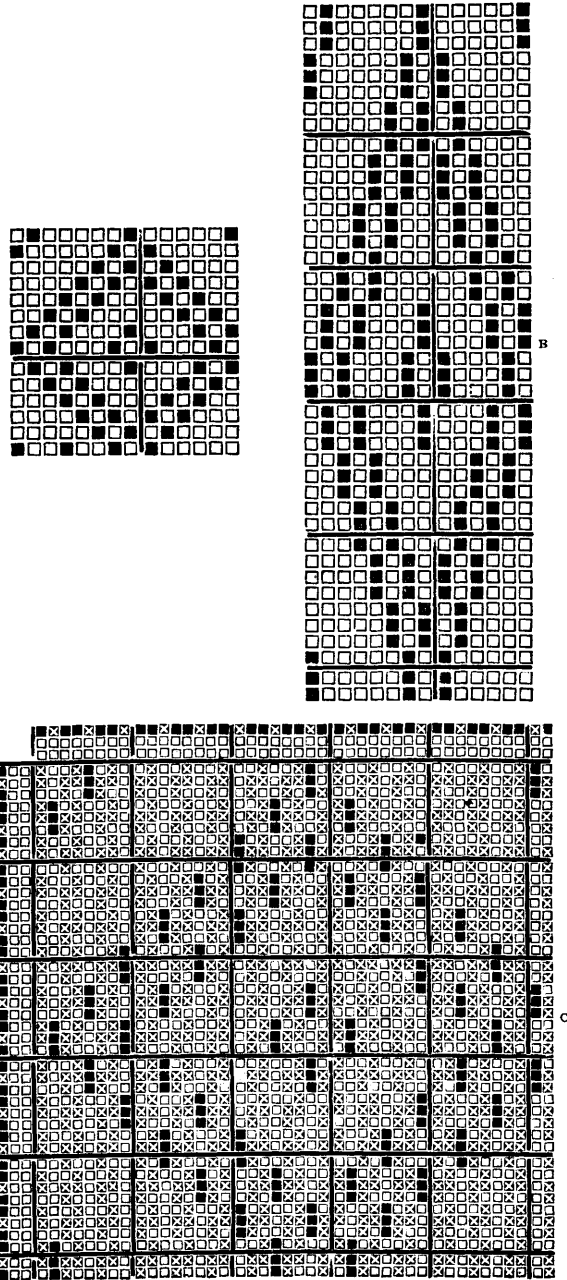

FIG. 312

follows:—Face sheds, healds working alternately, the figuring ends being raised; wadding sheds, all face healds, and figuring ends lifted; back sheds all face healds and half the figuring ends alternately. Again, by employing a tappet machine lift, the Jacquard mounting may be raised and kept up for any given number of picks, so that a card is equal to, say, one, two, three, or more picks, which, in the case of the last pattern, Fig. 310, would mean a saving of two-thirds of the cards. But we have also a great economy effected in the designing of a pattern; for since we have only to design for the stitching ends, and since each card may represent any stitch, then all we have to do is to get up the design in single dots, and cut the cards from that. To make this more clear, let A, Fig. 312, be the design, from which the cards are cut. If the griffe is stationary three picks for every such

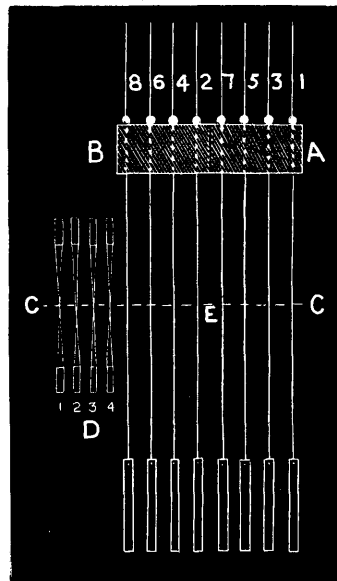

FIG. 313

card coming on the cylinder, each dot of A would equal a three-pick stitch, and would be lifting and figuring the cloth as shown at B in the same figure, C showing the full working of the threads

for a figure motive if woven by such a mounting as Fig. 310. Another modification of the ordinary Jacquard harness, and one commonly used in the manufacturing of figured piqués, toiletings, and quilts, is shown at Fig. 313, an end view of one row of couplings entered into the comber boards, and supposed to be tied up to a 400 Jacquard machine. A B are two solid comber boards tied up to top levers, and governed by tappets placed at the side of the loom. The couplings 1, 3, 5, 7, 2, 4, 6, 8 are knotted, the knots made at such a level as to rest against the tops of the boards, and are just large enough to prevent any coupling being left down when either of the boards is lifted; c is the warp line, the stitching or back warp going through the mails of couplings E, the face warp through the eyes of healds D, which are tied together so as to work as two staves. It will be noticed that the couplings are placed alternately in boards A B—that A takes all the odd numbered ones, B the even numbers. From this it follows that if A B are lifted alternately, plain cloth is produced by the backing ends, since the odd numbered threads would be lifted for one pick and the even numbered ones for the next. This is not only a card-saving arrangement, but it is also a means of economising the work of the designer; for, since the healds and comber boards are governed by tappets, their action need not be painted up on the design.

There is another matter of interest which is very often puzzling to students. In figured cloth belonging to this class the wadding picks as seen from the back of the cloth are drawn out of the straight and present a waded effect, running from selvedge to selvedge. This arises from the disposition of the stitching for figuring purposes—a given number of ends are carried into the face cloth, whilst a similar number are at rest; and since these wadding picks do not interweave with any warp threads, then they are forced out of the straight by the exigencies of the weave, such as the one shown at Fig. 314, a small diamond effect arranged in plain-cloth order, having six face picks to two wadding picks in each half of the pattern.

Fabrics of the Scotch or Kidder carpet class are double plain cloths, separate and distinct from each other, though each fabric is of a different colour. But here the apparent peculiarity of

their structure comes in. For the ornamentation of the fabric one cloth is carried through the other, this transposing of the two,

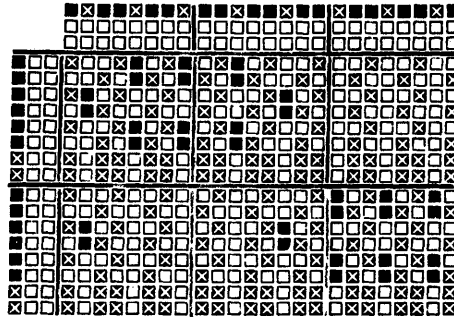

FIG. 314

securely and firmly stitches one to the other, so that we are

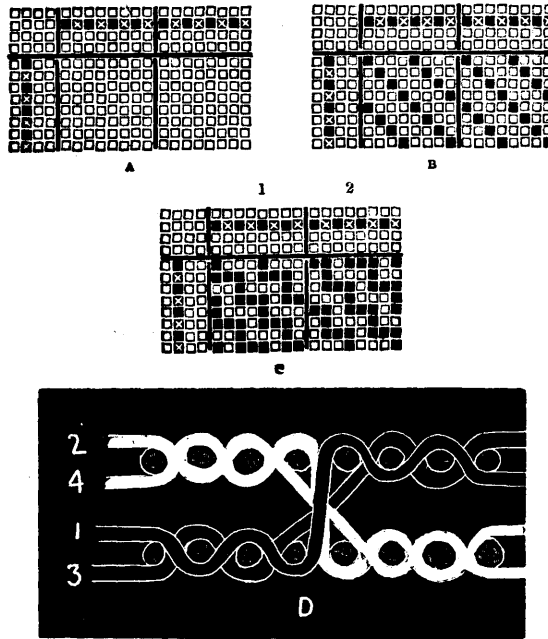

FIG. 315

presented with a perfectly reversible fabric. But since one cloth is, say, solid blue in colour, and the other, a solid grey one; the

figure on one side of the fabric will be solid blue on a grey ground, and on the reverse side the opposite to this. By examination it will be seen that the two series of warp and weft threads of opposing colours are made to interchange one with the other. Let the indicating line for the warp threads in A, Fig. 315, represent a warp made up of alternate threads of blue and grey, and let us suppose that alternate picks of blue and grey are inserted, as shown by the indicating bar for the weft. We may then proceed to put plain cloth on both sets of ends and picks, as shown at B, and presuming that the fabric is to be made up of alternate stripes of blue and grey running warp way of the piece, divide the number of ends placed at our disposal into two parts, 1, 2, and proceed to put the weave on both divisions in such a manner that when a blue pick is to interweave with the top cloth of division 1 it shall also interweave with the lower cloth of division 2; and that when a white pick is inserted into the lower cloth of division 1 it shall also interweave with the face cloth of 2. This is shown at C. This simply means that when a blue pick is inserted into stripe 1 all the white ends of stripe 2 must be lifted up, and that when a white pick is thrown into stripe 2 all the blue ends of stripe 1 must be lifted. This is made more apparent by section D, made from the first four picks of C, showing as clearly as possible that if any white pick is allowed to interweave with blue ends, or blue picks with white ends, the unbroken solidity of colour characteristic of these cloths would be affected, and an indefiniteness of pattern result therefrom.

Before proceeding to show how economies may be effected in designing for figured fabrics of this class, let us take one small example to show how figure may be produced. Let A, Fig. 316, be the figure motive, a chequered effect of alternating blue and white squares, which has the appearance of being complete on sixteen ends and sixteen picks. But since we know that underneath each blue end we have a corresponding white one, and that underneath a white one, a blue one, then the actual number of ends and picks required is thirty-two, as set out at B, which the student will readily understand from the previous example. It will be noticed how the weave changes on the seventeenth end and pick

for the purpose of producing the alternating squares of the design, so that what has been blue becomes white, and white, blue. But from this it will be seen that by adopting such a plan of designing for large figured effects a great expense in time and cards is incurred, as it is necessary to paint up the full details of one repeat of the pattern before the cards can be cut. Whether this may be minimised or not depends upon how the loom is gaited up, for if the ordinary Jacquard mounting is used it cannot. To show

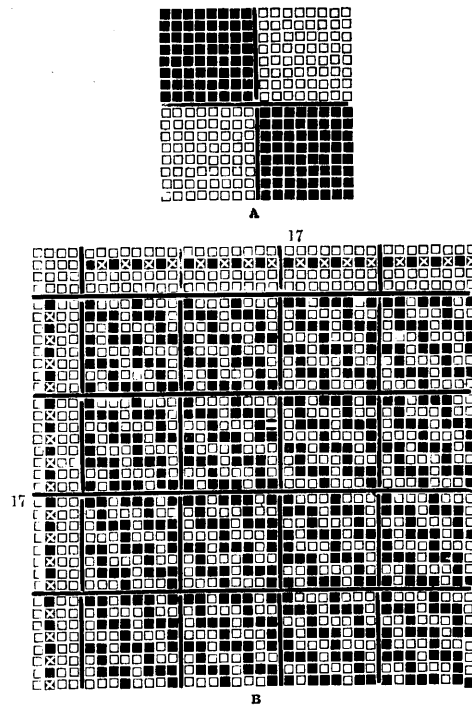

FIG. 316

what may be done in this matter as regards designing, let A, B, C, D, Fig. 317, be four comber boards, free to be lifted by a tappet arrangement placed outside the loom; also 1-8 and 9-16 the harness threads coming down from the Jacquard mounting, one-half of which passes through boards A B, the other half through boards C D, 400 hooks being used, the tie a straight one. The

warp is beamed with alternate ends of, say, white and blue, and these ends are drafted through the harness, so that the board A commands all the odd-numbered and B the even-numbered white threads, whilst boards C D, command all the odd and even-numbered blue threads respectively, the couplings being knotted above the boards for this purpose. By this arrangement of parts it will be seen that by lifting the first half of the hooks all white ends are lifted; that by lifting the second half all blue ends are lifted; that by leaving the hooks down and lifting boards A B alternately,

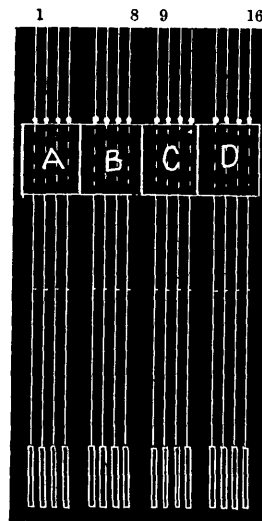

FIG. 317

and throwing in white picks of weft, a white cloth is produced, or by lifting boards C D alternately, and throwing in blue weft, blue cloth may be produced. Keeping in mind the last examples, that by the mere action of the boards two separate and distinct cloths of different colours can be woven; it will be further seen that after producing, say, a given length of white cloth on the face, it may be made to change places with the blue cloth, and so produce stripes of coloured cloth running from selvedge to selvedge. Further, if some portion of the white mounting is lifted with a blue board, and a blue pick is inserted, one portion will appear on the face and the other on the back; also, if some portion of the blue mounting, along with a

white board, is lifted, and a white pick is put through the shed, it will take up a reverse position to the blue one. These possibilities form the basis of all designing for such a mounting.

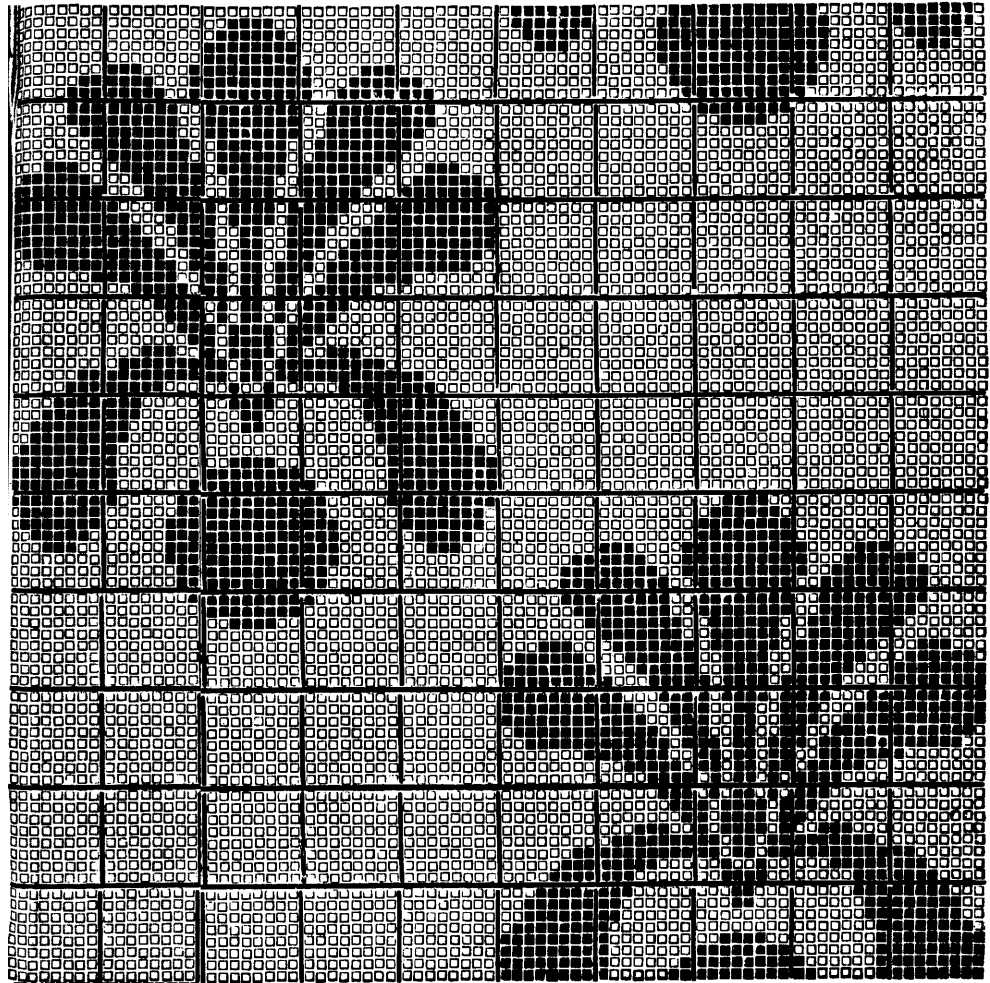

FIG. 318

From what has been said the student will infer that the purpose of the machine is simply to produce figure, and that the cloth is

made by the independent action of the comber boards. If this is so, then all we have to put on point paper is the figure, and to cut the cards from that. Take Fig. 318 as a design, the figure of which is to be blue upon a white ground, the harness is to be used as shown at Fig. 317, the first half taking the white, the second half the blue. If we cut ground on the first half of the card, lift a blue board and throw in a blue pick, we have woven one pick of the figure; if on the second card we cut figure on the second half, lift a white board and throw in a white pick, we add one pick to the ground. From this we have these instructions for the card-cutter—On the first half of all the odd-numbered cards cut white, on the second half of all even-numbered cards cut figure, cards to be laced one and one.

By such a method of gaiting and designing it will be readily seen

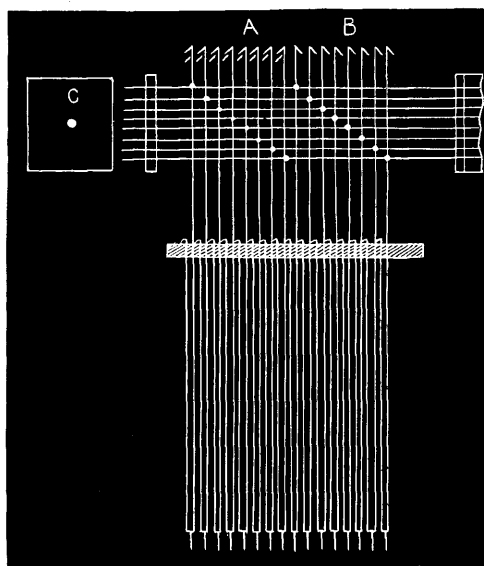

FIG. 319

what a great economy is effected in designing, but at the same time it will be seen that no saving of cards takes place, as a card is wanted for every pick put into the cloth. But there are machines used of a compound character whose parts are so arranged that one card stands for two picks, thereby saving one-half of the total number of cards

represented by the pattern. Such a machine is illustrated by sketch Fig. 319, where the two halves A B have their hooks set in opposite directions, one needle operating two hooks. If the cylinder c presents a card to the needles, then for every hole the corresponding hook in portion A will be caught by the griffe bars, and lifted up. When the griffe of portion A is up, that of B is down; and since the hooks of portion B are set opposite to those of A, then the blank places of the card will push corresponding hooks of B on the griffe bars, so that on the next pick they will be lifted. But since the mounting from A and B may be operated by the boards commanding white and blue threads respectively, we have an effect produced by one card, which, by the last method of gaiting would require two cards. Thus we have by this system of designing and gaiting economies effected which are of the greatest importance to all concerned.

Tapestry cloths present a very wide range of construction and coloured effects, which, in many cases, are intricate in their build and offer difficulties to the student not readily overcome; for we may have warp and weft threads so multiplied either as to colour or material that the weaving of them together for a particular end is truly a puzzle, and belongs to the most advanced cloth structure a student may attempt.

Ornament in these fabrics principally depends upon colour, without which details of figure could not be so clearly expressed. The several series of warp and weft threads might be interlaced in the most intricate manner as required by the build of the fabric, but if they were all of one colour we should have a very indistinct pattern. We may have tapestry fabrics made from two wefts and one warp; two warps and one weft; one warp and several wefts; several warps and one weft; and several wefts and warps, each interweaving with its own or other weft or warp threads for the purpose of creating some portion of any given figure.

Beginning with the simplest make of such cloths—that where two wefts and one warp are employed—let us first examine the principle of construction underlying all tapestry fabrics, by taking A B, Fig. 320, where A is any portion of a given figure and B the section made from it. Here we have simply an eight-end twill, four up and four

down, the diagonal effect to be produced in two colours, say the ground red, the figure blue. If we lift threads 1, 2, 3, 4, and throw in a red pick of weft, we have this pick showing on the face of the cloth, because it floats over threads 5, 6, 7, 8; but it also shows on the back of the cloth, as it floats under threads 1, 2, 3, 4. So also for the blue pick, which immediately follows. If threads 5, 6, 7, 8 are lifted and threads 1, 2, 3, 4 left down, we have this blue

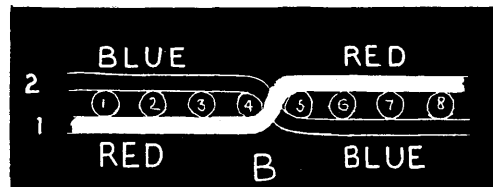
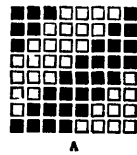

FIG. 320

pick inserted into the cloth in reverse order to the red one. From this we have the section B, which shows that alternate ribs of red and blue run diagonally across the cloth; that the cloth is perfectly reversible, since the pattern is the same on both sides; but that the colours are opposite to each other on the reverse sides of the cloth; that two picks of weft go to make one pick of the design, because, since pattern is dependent on colour, one pick must begin where the other leaves off. That this method of building and ornamenting a fabric may be applied to the most varied form of Jacquard work may be inferred from what we have shown; but we must not forget the fact that when we have large figures to deal with which present masses of the various wefts to the face of the cloth, these must be bound together by some ground weave. Let Fig. 321 be any portion of a design to be woven by a Jacquard having the ordinary straight tie, the colour scheme to be blue and gold. Having painted the figure in solid colour, we

have the binding to consider, because the whole of the texture has to be produced by the same warp threads. By carrying a regular twill or a satin weave across both ground and figure this will be accomplished. But we must not forget that both wefts have to be bound on the face as well as the back of the cloth, and for this

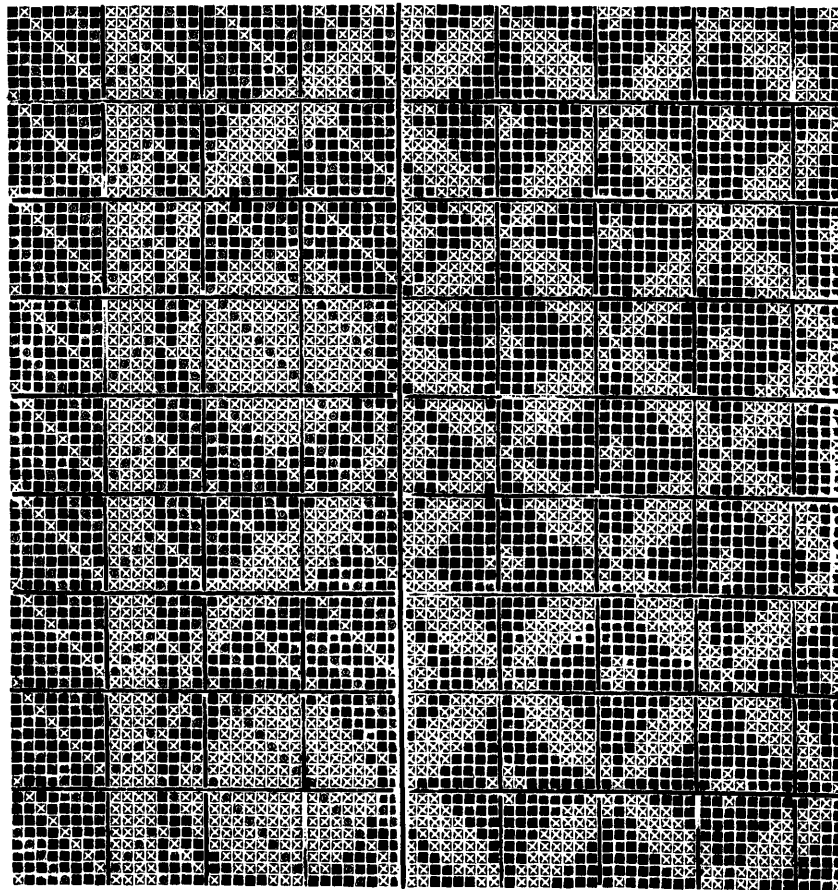

FIG. 321

reason two sets of binding marks must be arranged on the design. In the example these are shown by the markings, thus—
 The ☒ on the solid parts bind one weft, whilst the ■ in the ground

bind the other, and the design is ready for the card-cutter. The instructions to be given are as follows :—Blue pick cut all \boxtimes ; gold pick cut \blacksquare and \boxplus .

By a special mounting some of the designing incident to fabrics of this class may be saved, because binding need not be considered, no matter how many wefts are to be used. This is effected by placing in front of the Jacquard harness two staves of healds, 1, 2, Fig. 322. Two warps are used, the figuring warp being drafted into the Jacquard

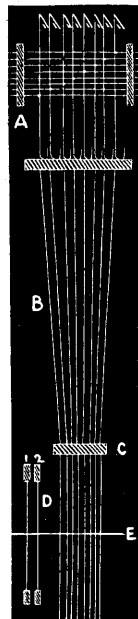

FIG. 322

harness, whilst the stitching warp is drawn into the healds alternately, one end of which is entered into alternate dents of the reed, so that the whole is dented two figuring ends in one dent and two figuring and a stitching end in the next. Taking the design Fig. 323, and transferring it to point paper and painting its parts in solid colour, it is ready for the card cutter, his instructions being for the first pick cut figure, for the second cut ground, cards to be laced one and one. Taking these and placing them upon the

Jacquard cylinder, we have this round of shedding—First card, the machine and No. 1 heald stave lifted; second card, the machine and No. 1 heald stave lifted; third card, the machine and No. 2 heald stave lifted; fourth card, the machine and No. 2 heald stave lifted. From this it follows that the stitching ends make plain cloth two picks in a shed.

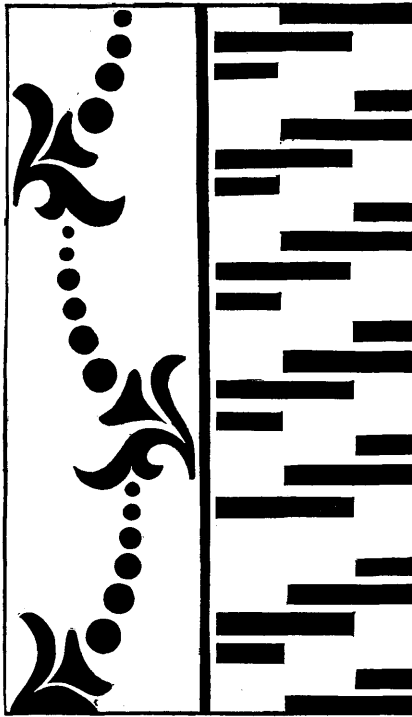

FIG. 323

If three wefts were used, each heald would have to stand for three picks, and so on for any other number of wefts, and by this method of stitching a new feature presents itself, the stitching running in parallel lines the length of the fabric. If the extra warp is too prominent it will reduce the expressiveness of the design, so that such threads should be as fine as is consistent with a due

degree of strength for the work they have to do. In another division of this class of fabrics the figuring warp threads can be brought to the face of the cloth as a piece of colour to make more prominent some detail of figure, in which case they are simply lifted over all weft threads for as long as they are wanted. When such a working takes place, the fabric is not reversible. There are other weft tapestries which are not reversible, the several figuring wefts of which come to the face of the cloth, produce their portion of the figure, and are then thrown to the back, to which they are bound in a somewhat loose manner, but so that the binding points do not show on the face of the cloth.

The actual build of tapestry fabrics where several wefts and one figuring warp are employed, and when the wefts must be stitched to the body of the cloth after producing their portions of figure, may be illustrated by the following:—Let A B C D, Fig. 324,

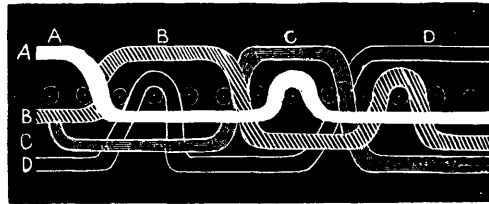

FIG. 324

be four consecutive picks of weft thrown into a fabric. As these are of varied colours, the points of attachment must not show on the face of the cloth, and as far as possible a regular arrangement of the stitching points is to be desired. Such is shown in the illustration. As each weft is thrown to the back of the cloth, it is fastened thereto by being interwoven behind the figure—A behind C, B behind D, C behind A, and D behind B. But if a stitching warp were used, these nice points of cloth structure, which really give to this kind of designing its intricate character, would need no consideration, as each heald stave, rising and falling consecutively according to the number of wefts used, would bind the whole together. A longitudinal section, Fig. 325, made from Fig. 324, will show this. A B C D are the four wefts as shown in the first

part of Fig. 324; E is the figuring warp over which the pick A is floating, whilst F G are two stitching ends working in plain order, four picks in a shed. We ought to say that the stitching ends used in such cloths as these need not be always dented one end in

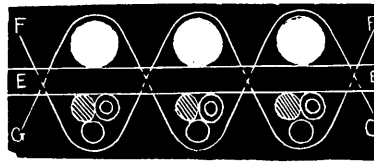

FIG 325

alternate dents, but may be used so as to create small matting and ribbed effects in the figures, providing the weft floats are not left too long.

In making tapestries where two warps and two or more wefts are employed the methods already discussed are modified, but the modifications are so important that we must give an example of their application. The loom is mounted with one or two Jacquard machines. The comber board is divided longitudinally into two sections, and two staves of stitching healds are placed in front of the harness. The warp threads, of two colours, are wound upon the same beam, the stitching warp upon a second one. If only one machine is used, it is divided into two equal parts and tied up so that one half takes the front and the other the back half of the board. The arrangement of this detail is illustrated by Fig 326, where A B are the two halves of the machine; the mounting of A coming to the front and that of B to the back half of the comber board C; 1 2 are a pair of healds; D is the warp line. The stitching warp is drafted into the healds, the figuring into the Jacquard harness, but in such a manner that by lifting either half of the hooks all one colour is raised, which really means that A is capable of producing a cloth irrespective of B by cutting a pattern on the A division of the cards; similar conditions apply to B. From this it follows that A may produce any portion of a figure in its own colour, whilst B does a similar piece of work in its own colour; that A may produce figure on the face

whilst B is out of action, and vice versâ ; and that A or B may be called upon to produce face or back figure, according to the exigencies of the design.

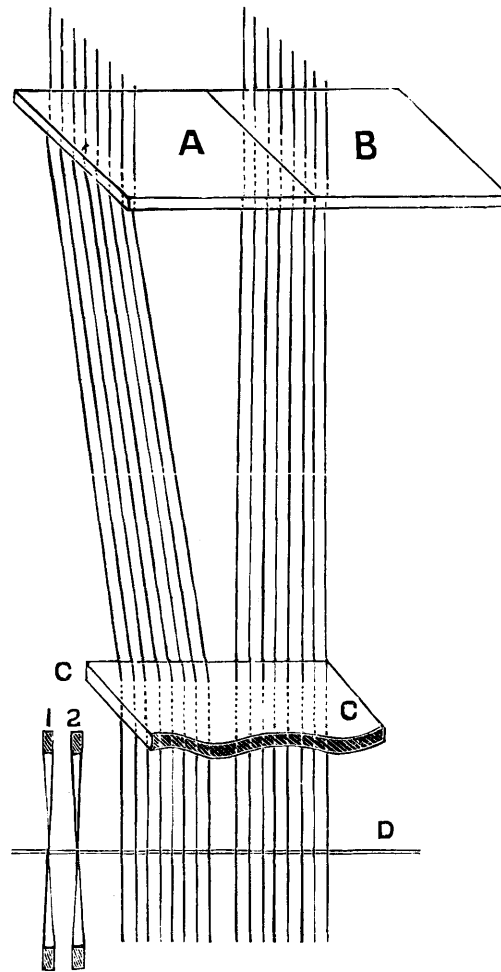

FIG. 326

We have already said that figure principally depends on colour, so that the designs on point paper may be painted up in the

colours intended to be used in the cloth. Students particularly would do well to follow this method when making designs for experimental work, until they have gained by experience knowledge enough to make any kind of paint on point paper represent any colour scheme they may desire to express in cloth. At Fig. 327 is given a characteristic piece of ornament common in tapestry fabrics. Two wefts and two warps are to be employed as shown by the various markings, in addition to which we have the stitching warp, which is not shown in the design, since the

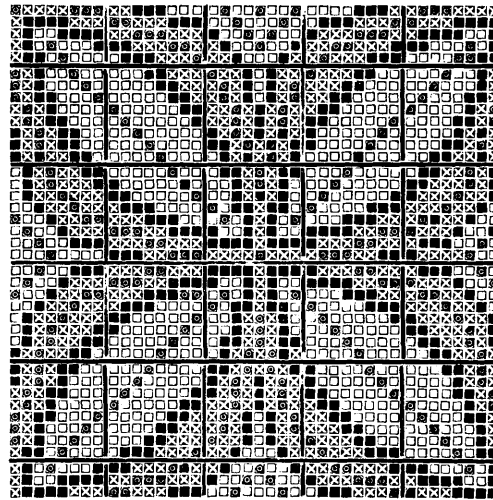

FIG. 327

healds through which it goes are operated by tappets placed outside the loom. Let the colour scheme be denoted by—

Weft: Black ■ Warp: Red ☒
 „ Blue ■ „ Gold Blanks

portion A of the machine to govern red warp, B to govern gold, the picking to be consecutive picks of black and blue. Since each pick of the design represents two cards, one for the black weft and the other for the blue one, we have these instructions to give to the card cutter—Black pick, cut red and blue on first half of card, and gold and blue on second half; blue pick, cut

red and black on first half, and gold and black on second half, cards to be laced one and one. The result of this cutting is, that beneath red we have gold ; beneath gold, red ; beneath black, blue ; and beneath blue, black ; and that when the wefts are not being used for figure they are lying between the two systems of warp threads.

This is a proceeding which often leads to very complicated card-cutting, the cutter often having three or four colours to cut for some given pick.

CHAPTER XIV

CROSS WEAVING

THE characteristic features of this division of woven fabrics are so well marked that little difficulty is experienced in distinguishing so endless a variety of what are known as gauze and leno fabrics from fabrics belonging to other divisions of woven textures. The term cross weaving is an inclusive one, embracing all woven effects where one set of warp threads is partially or wholly twisted round another set, this twisting so forcing them out of the straight that they do not lie parallel to each other, or at right angles to picks of inserted weft. Hence we have such terms as "net" and "lace" applied to many varieties of cross weaving. And this term cross weaving is a very apt one, for it implies what actually takes place in producing pattern: given threads of warp certainly do cross over from side to side of a second set of warp threads, constraining them to run together, by which we have all those open, perforated effects so characteristic of the generality of gauze and leno cloths. A B, Fig. 328, where A is the section and B a plan, will show the nature and illustrate the principle of all cross weaving. It will be noticed that one set of warp threads alternate first to one and then to the other side of a second set of threads; that whilst in these positions picks of weft have been inserted; that one set of threads is always lifted for the insertion of such picks; and that the second set of threads is not lifted at all. Hence we have the descriptive names, crossing ends and standing ends, given to the respective threads. When the crossing ends are lifted so as to be parallel with the standing threads, we say that an open shed is formed, and that the pick inserted is put into an open shed; but when they are

lifted on the opposite side of the standing ends, then a cross shed is formed and the pick put in is a cross pick. If the topmost pick in B is put in an open shed—because the crossing ends are parallel to the standing ends—then the succeeding



A

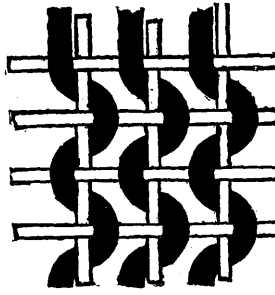

B

FIG. 328

pick is put into a cross shed, an order of shedding which is repeated over and over again, and represents a foundation or initial weave which may be and is modified in almost endless variety.

The means employed to do this work are generally of a very simple character, as shown by the sketch, Fig. 329, which illustrates the arrangement of healds known as a bottom doup mounting. A B are two threads drawn through two healds placed on staves 1, 2, each of which is capable of independent action. This is called the back mounting. Placed in front of this is the standard and doup. s s, the standard, is a whole heald, whose function is to support the doup; connected to this at the eye is the half-heald or doup E, which is attached to the stave D. As the ends leave the back mounting they are crossed; in the sketch, A is passed under B and then through the loop formed by the half-heald or doup; they are then drawn together into the same dent of the reed.

By such an arrangement of parts, it follows that thread A is capable of receiving movement at two points, c, E; that if lifted at E it will be partially twisted round B, if at c that it will be lifted parallel to B, so that no crossing of the two would take place. But it must be evident that thread A cannot be lifted at c to form a shed

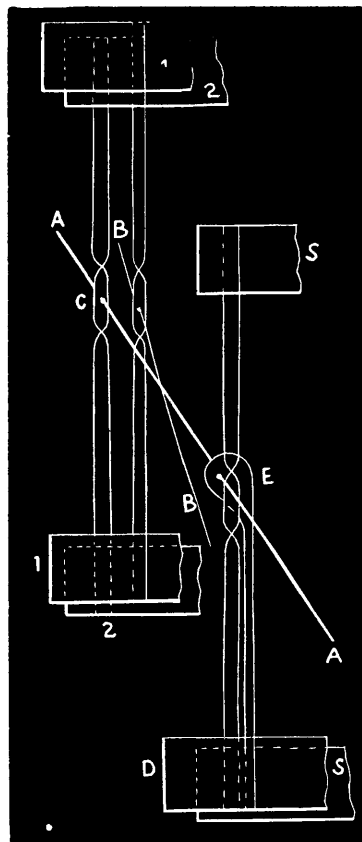

FIG. 329

without being first released at E, as it is held tight against the standard by the doup. This releasing of the crossing thread at E, to form an open shed, is shown by the sketch, Fig. 330. Here we have the crossing end, A lifted in the back mounting at c by lifting

up No. 2 stave. We have also the doup stave *D* lifted, which, allows *e* to slide up through the standard eye by reason of the thread being lifted at *c*, allowing that thread to assume a parallel position to thread *B*, and so form the open shed. At Fig. 331

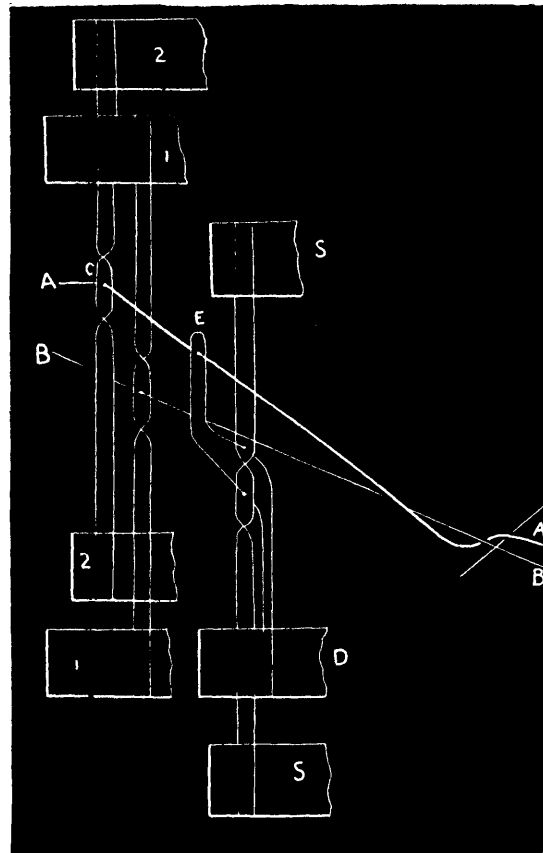

FIG. 330

the formation of the cross shed is shown. It will be inferred from what has already been said that this can only be done by lifting the crossing end at *e*, and that in doing so the thread must be kept tight against the standard *s*, so that we have the two back staves *1 2* left down, and standard *s* and doup stave *D* lifted together, by

which the thread is lifted at E, and a partial twist given to the two threads.

This means, that to form an open shed the back heald 2 is lifted and standard and doup left down; to form a cross shed the

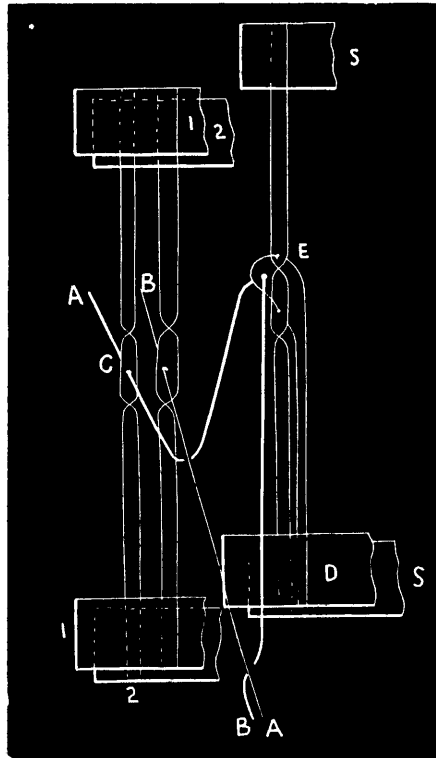

FIG. 331

standard and doup are lifted and the back mounting left down; which may be expressed by making a plan of the heald staves, the relationship of the ends to each other when placed in the healds, and the order in which the healds have to be lifted to produce the desired effect. Fig. 332 shows the method of doing this, which is really nothing more than getting out the draft and tie-up.

In forming the cross sheds there is yet another matter we have to consider. The crossing end being held down at c,

Fig. 331; it is not free to lift behind this point, as it is when an open shed is formed, as shown at Fig. 330; consequently a very severe strain is put upon such crossing threads. This must be relieved by

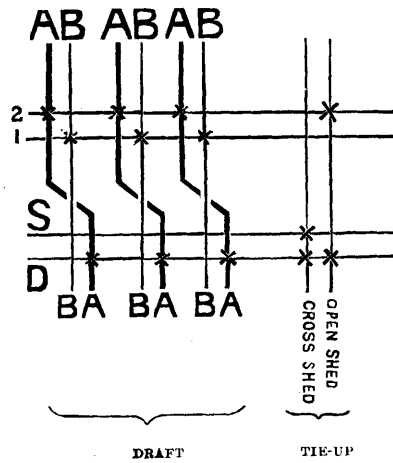

FIG. 332

easing all crossing ends when a crossed shed is being formed, to obtain which, all such ends are brought over a vibrating back rest,

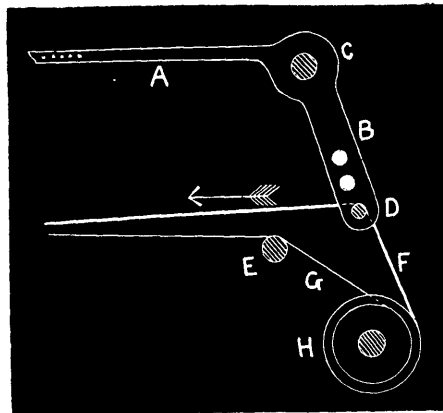

FIG. 333

free to move towards the healds. Perhaps the simplest form of easers, or "slackeners," as they are sometimes called, is the

one shown by the sketch, Fig. 333, where A B are two arms of a bent lever having its fulcrum on a stud c, placed conveniently in the back framework of the loom; D is a stout, round bar free to revolve and resting in arm B of lever A B; E is the stationary "rest"; F G are warp threads coming from beam H; the crossing threads, F, are taken over D; the standing ones, G, over the ordinary rest E. Two such levers as A B are used, one for each side of the loom; and the rod D rests correspondingly in one and the other. The arm A is suitably connected by a cord to a tappet, dobbie, or

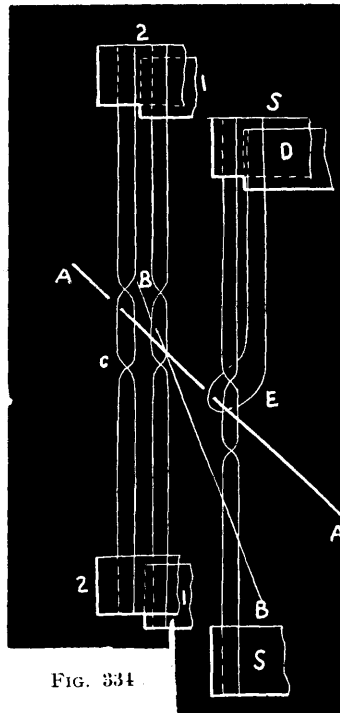

FIG. 334

Jacquard, so that when A is lifted, D, moving in the direction of the arrow, is brought nearer to the healds, consequently all threads going over it are eased.

There is another method of using a doup heald which has advantages that ought to bring it into more prominent use. We mean the arrangement known as a top doup where the doup

heald or "slip" hangs down from a stave placed above the yarn. This arrangement of mounting is shown by sketch Fig. 334, where 1 2 are back heald staves; s D are standard and doup; B A are standing and crossing ends, drafted into 1 and 2 respectively, but the crossing end is taken over the standing end before it is placed in the doup, not under it, as in the previous arrangement. This change in the relative positions of crossing and standing ends and the doup, alters the tie-up for forming the several sheds, especially as the doup is not free to lift without the standard.

Considering the sketch, and not forgetting that the crossing end is over the standing one, we have the two kinds of sheds made as follows:—Cross shed c, 1 and 2 lifted and s D left down; these movements cause the crossing end A to be held down at E and thread B to be lifted. For the open shed o, lift 1 and the standard s, by which A is held down at c and B is free to lift parallel to A, since the crossing end is released at E by the doup sliding down through the standard. The draft and tie-up, Fig. 335, show the working, the

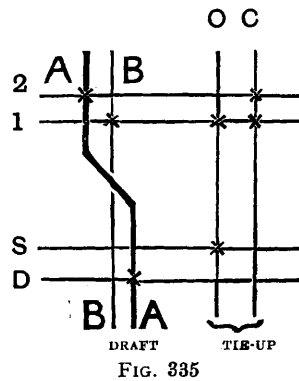

FIG. 335

letters and numbers referring to the corresponding parts in each figure. Those who have adopted the top doup system of cross weaving for leno work claim for it that as pattern is produced on the face of the cloth, the weaver can the more readily see what is taking place; and that all worn-out doups are more easily replaced than in the under doup system.

Having seen what means are employed to give an open or crossed shed, let us examine how these may be combined with plain cloth; for without doubt these combinations form the basis of all leno weaving. And perhaps it will be as well to give a definition at this point of what is meant by the terms "gauze" and "leno," for they are often misapplied. Gauze is a fabric produced by crossing one end round one and putting one pick in a shed; leno is a combination of gauze and any other weave. Fig. 336 is a leno—a sketch to illustrate the combining of plain

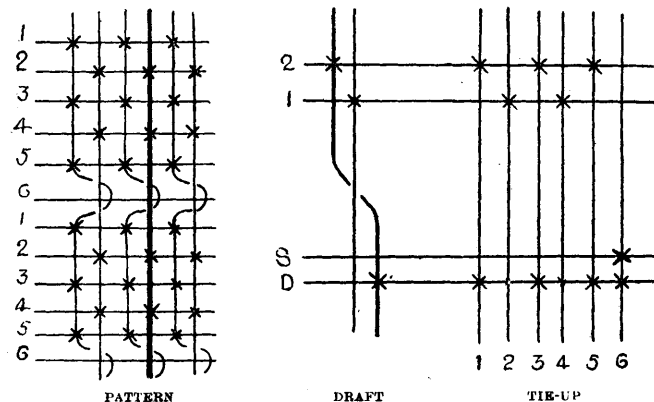

FIG. 336

cloth with gauze when woven by the bottom doup arrangement. Five picks interweave in plain order, the sixth pick is put into a cross shed. But the plain cloth must be made by the alternate lifting of the two ends by the back staves 1 2, and therefore the crossing end must be released by the doup whilst these sheds are being made as shown by the tie-up in this figure. But plain cloth may be made as shown by Fig. 337, a leno pattern known as "cross over." As the sketch shows, in the first half of the pattern the picks are inserted in sheds made when the two threads are not crossed about each other, but between the fifth and sixth pick these ends practically change places, the crossing end being kept on the crossed side for the second half of the pattern; and as the tie-up shows, consecutive picks are inserted in sheds

formed by alternately lifting standard and doup together on one pick, and No. 1 heald stave (the standing end) on the other.

But we can go a step further, and so long as we confine the working to one end crossing one and one pick in a shed, figure of a chequered character can be produced by combining the plain with

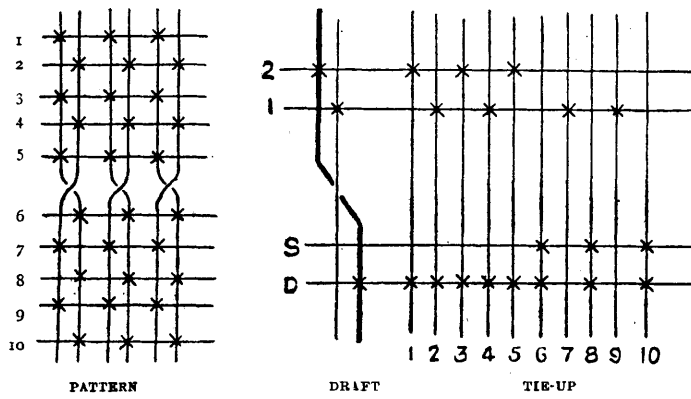

FIG. 337

gauze weave, as illustrated by the sketch plan of pattern, draft, and tie-up, Fig. 338. Examining the pattern, we see one set of ends making plain cloth, whilst another is making gauze, which compels

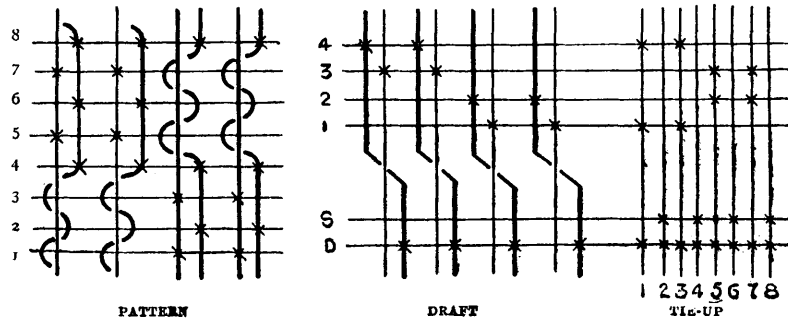

FIG. 338

the use of four staves of healds for the back mounting, as shown by the draft. But the plain cloth is made by keeping the crossing end on the crossed side whilst the second set of ends is making a cross

shed, which means that a crossed shed is being made for every alternate pick of the shuttle. This will be seen by examining the tie-up, which shows the formation of cross sheds on every even-numbered pick. By increasing the number of heald staves in the back mounting, and by dividing and drafting the ends in sets, very large patterns can be made, which at first sight look as if they required a Jacquard machine for their production.

Having examined the methods pursued in partially twisting two

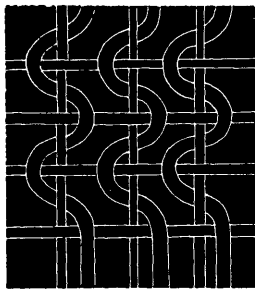

FIG. 339

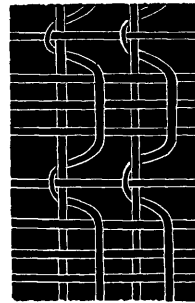

FIG. 340

threads about each other by the aid of a doup heald, let us consider how these methods may be modified so as to produce more elaborate patterns. These are so varied in character that we must needs

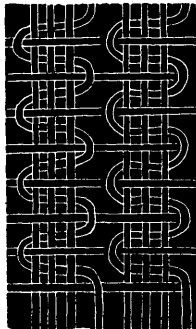

FIG. 341

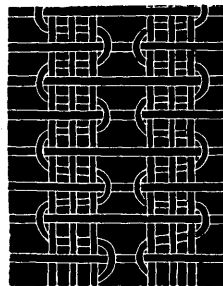

FIG. 342

content ourselves with examining a few well-defined types, such as may be made the basis of further modification. We may produce pattern by crossing one end round one, putting one or more picks

in a shed, as shown by Figs. 339-40, the latter showing three picks in an open and one in a crossed shed; any other number of picks may be put in consecutive sheds. But one end may cross about several ends, as in Fig. 341 whilst the several ends are working together as one end, so as to give increased strength to withstand the strain put upon them by the crossing end, that end may be

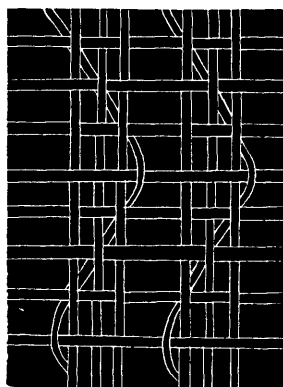

FIG. 343

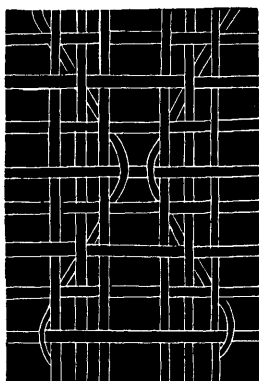

FIG. 344

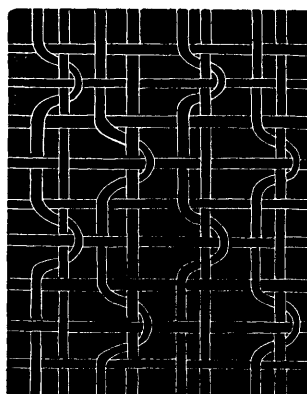

FIG. 345

increased in thickness so as to predominate in bulk over the others, and it may be of same or of a different colour. This weave may be modified by reversing the order of drafting, as in Fig. 342, where the crossing ends are alternately brought together and then taken away from

each other, producing a more open effect than the one given by the previous weave. But pattern may be created by the intermittent crossing of one end about several, either in the same or opposite directions, as in Figs. 343-4, which show the crossing ends lying out of action between one crossing point and the next, and that the intermediate picks are interweaving with the non-crossing ends in plain order, thus forming a ground cloth upon which the crossing ends are loosely lying. We may, too, form pattern by such weaves as those shown at Figs. 345-46, where the crossed sheds are formed

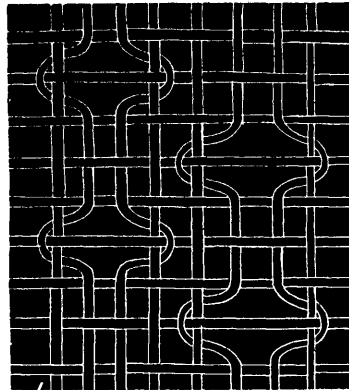

FIG. 346

at various times—in the first of which all the ends cross in the same direction, whilst in the second, the cross sheds are made by reversing the direction of half the crossing ends. These weaves are compounded of cross and plain textures, each pair of ends making plain cloth for three picks both before and after a cross shed has been made. But the greatest variety of detail in a pattern is only got by combining various weaves together; and though such combinations may add to the difficulty of production, yet they may also add much to the effectiveness of the design as a whole, if due consideration is given to the proportion of parts and material, since each weave gives an effect peculiar to itself. An example of combined weaves is shown at Fig. 347, which is made up of weaves shown at Figs. 341 and 346, and these are of such a

character that not only would warp threads be drawn out of the straight, but the picks as well could not lie parallel to each other.

In addition to this, colour may be largely used, and such weaves as twills, satins, diapers, and brocaded figures running in stripes may be requisitioned, and by contrast help to make more pronounced the open work effects. The openness of the gauze or leno stripes may be increased also, by leaving empty, given dents of the reed between those through which each pair or set of crossing ends are passed, and it goes without saying that a crossing end or ends, and those about

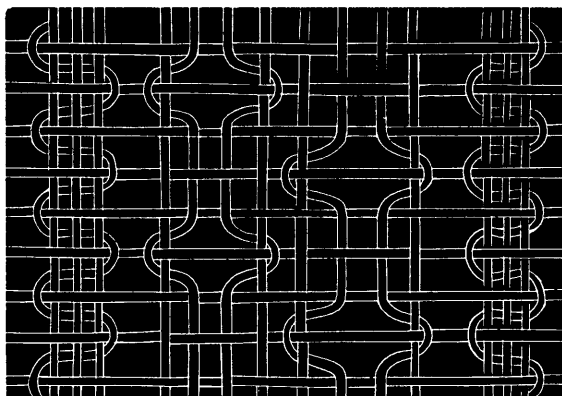

FIG. 347

which they cross must be drawn into the same dent of the reed, or no crossing could possibly take place.

In making the drafts and ties for stave work cross weaving, the simplest is the hand-loom method, because we see in plan what actually takes place, not only as regards the crossing of the ends, but the lifting of the several heald staves as well. Determining the number of healds for the back mounting as we should for any other pattern, the number of standards and doups required is determined by the nature of the crossed work. If all crossing ends in a pattern work alike, as in Figs. 339, 40, 41, 42, 43, 44—that is, if all crossing make the same intersections and at the same time—then one standard and doup only is required; but if, as in Figs. 345-6, the crossed sheds are made at different times, two standards and doups are needed; whilst in such patterns as Fig. 347, where we have not

only crossings being made at various times, but different orders of crossing combined in the same pattern, three standards and doups will have to be used. This means that we shall require as many standards and doups as there are kinds, or orders of crossing, because one standard and doup may not make an open and crossed shed, or make two different crossings at the same time, except in such fabrics as illustrated by Fig. 338. As an example let Fig. 343 be

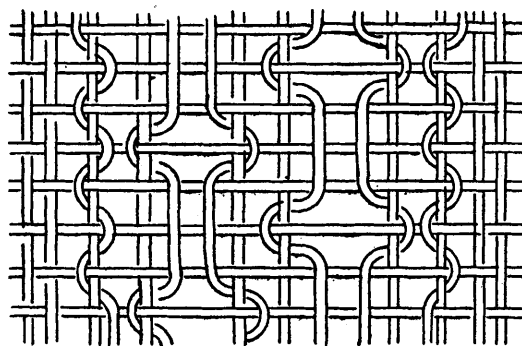
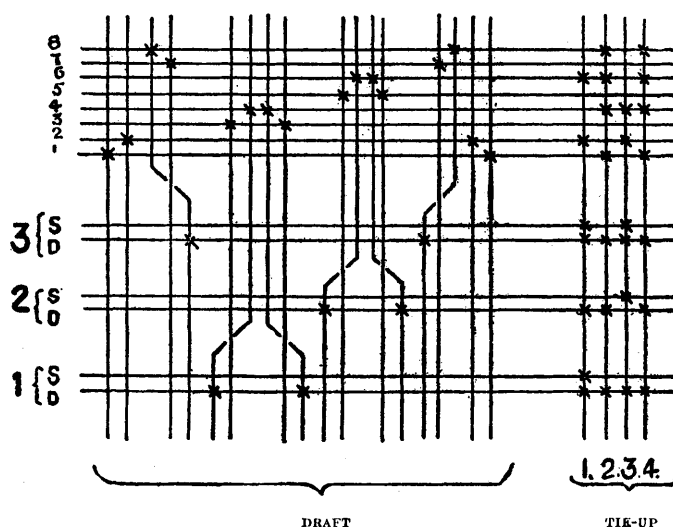

FIG. 348

a pattern for which draft and tie-up are required. Examining the pattern, we see that plain, gauze, and leno are combined together, and as the plain needs two staves of healds to produce it, the gauze two, and this particular form of leno four, eight staves are required in the back mounting; and since there are three different times of crossing the gauze and leno ends, three standards and doups; the whole mounting consisting of fourteen staves. The draft and tie-up, Fig. 349, shows the setting-out of the healds and their action. In making drafts for this kind of work it is advisable to group the ends of any given working together on the required number of staves, always putting the crossing end or ends on the backmost staff of its set. This makes the drafts easier for the weaver, and if the crossing ends are drafted in doups so as to be equally distant from their respective back mountings, the strain put upon the crossing ends during the formation of the crossed sheds is more nearly equalised, which method is followed in the present case. But it will be noted in this

example the easing of the crossing ends has not been taken into account, nor is it necessary, for since these bars are generally tied up to the same hooks as their respective standards, the action of one is the action of the other, hence no separate marking is required in making out the drafts and ties. Of course, if separate hooks are used to actuate the easing bars, their drafting and action must be shown in the draft and tie-up. Another point we wish to draw a student's attention to is, that the sketches given to illustrate this part of the work are only meant to show the weaves by which varied pattern is obtained, and not the effects such weaves



DRAFT
FIG. 349

TIE-UP

would present when the cloth is woven; for in many instances, not only are the crossed and crossing threads pulled out of the straight, but the picks as well are so affected that they are turned out of their course and cannot lie parallel to each other.

The putting of pattern, draft, and tie upon point paper for cross weaving is all the more difficult for a student to understand, since one cannot show what actually takes place when one thread is twisted about another. Take gauze as an example. When the cross shed is formed, the crossing end is lifted between the second

and third ends of the pattern, which cannot be painted up on the paper because at that particular place there is no square on which such a rising mark may be put. It follows that the formation of a cross shed can only be indicated as taking place, which is equally true as regards the painting up of drafts for this class of work. Fig. 350 will illustrate this, where A is the pattern; B the draft;

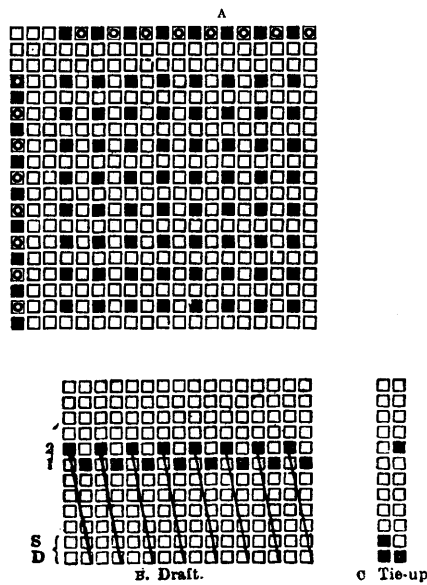

FIG. 350

c the tie-up; the two horizontal spaces s d represent standard and doup; 1 2 the heald staves for the back mounting; whilst the indicating bars of A show by the solid black dots the crossing ends and the cross sheds. In the pattern A all cross sheds are left blank for the reason already given. In the draft B the direction of the crossing ends is shown by the oblique lines running from left to right, which are simply indicating lines, since the position of those ends in the doups cannot be expressed on point paper. The tie-up c shows the first pick as a crossed shed formed by lifting standard and doup together, the second an open shed formed by releasing the crossing end in the doup and lifting it by the back mounting.

Fig. 351 is a design illustrating a two-doup pattern with draft and tie-up—a checked effect produced by the continuous cross weaving of the first eight ends of the pattern, two ends crossing two, four picks in a shed, and plain on the second eight ends, which are arranged one end crossing one, forming one cross shed for three

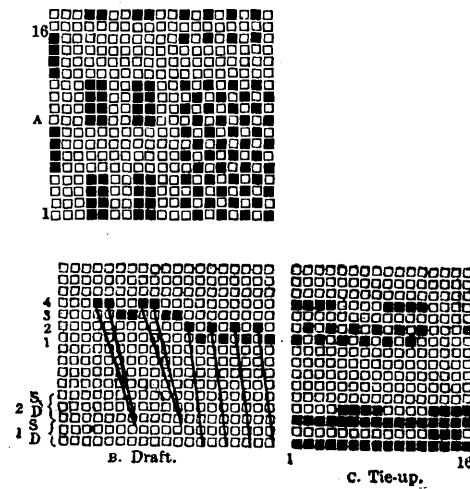

FIG. 351

picks in each repeat of the pattern. In the draft, two droups are shown, necessitated by the varied crossings of the two sets of warp threads, which are indicated as going through the droups in the manner explained in the previous figure.

Many designers indicate a cross shed by painting them up in a different colour to the open ones, as shown by Fig. 352, which is the design portion of Fig. 351, the solid squares representing the open, and the dots the crossed sheds. But this is scarcely necessary, since the cross sheds are not formed by lifting the ends at the places indicated, and only adds to the labour of designing.

It is not within the province of the present work to examine the mechanical details of shedding motions employed in gauze and leno weaving. Consisting as these do of tappets, dobbies, and Jacquards, their adaptability to cross weaving is comparative, the value of any one depending upon the character of shed formed by it.

One gives an open shed, by causing the yarn to pass from one extreme point of the shed to the other, only when required by the exigencies of the pattern, and may be taken as an example for the present purpose. At A, Fig. 353, is shown the general character of this

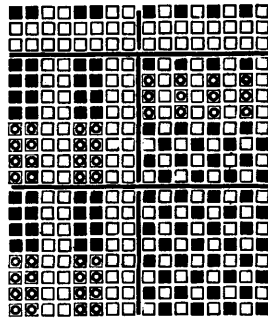

FIG. 352

shed, the yarn moving as shown by the arrows. But if the crossing end, B, is to cross about thread C, it must be evident that the two cannot maintain the positions they at present occupy. B may be lifted by the doup for one pick, and on the next by the heald stave of the back mounting, so that during this change it is only brought half-way down the shed. To enable B to twist about C, C must be lifted up half a shed by bringing it to the level of the dotted line D.

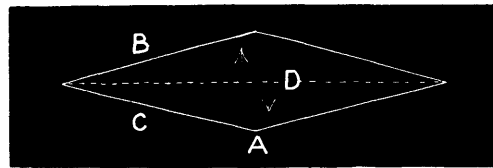

FIG. 353

For this purpose auxiliary motions, known as "shakers" are used, which are of several types, but the best known is shown at Fig. 354. A is the crank arm, to which at E a link D is attached. This at F is connected to lever G, having its fulcrum at H, which is a rod running across the width of the loom. On the same rod, and behind G, are two corresponding levers, one at each side of the loom, to which all heald staves governing standing ends are

attached by cords such as J, whilst cords I connect the same to the shedding motion. Hence as the crank arm is lifted up by the crank B in moving through the upper part of its revolution, the transverse rod H is oscillated, causing an upward movement of half a shed to be imparted to the heald staves connected thereto, the parts of course being nicely adjusted to give to the heald K the necessary movement. This means that all standing ends are brought level with the crossing ends, and the sheds are made with practically as

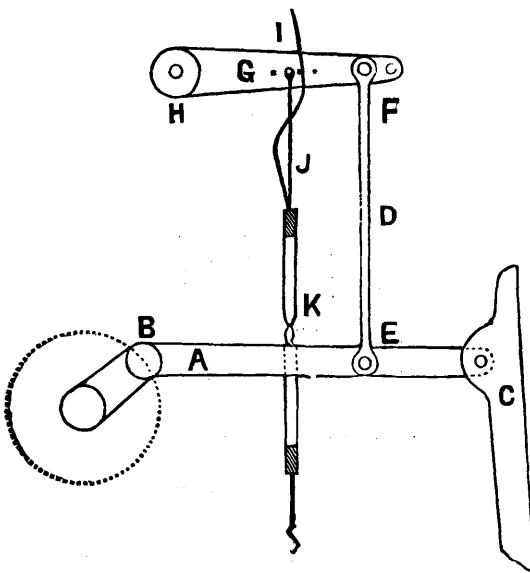

FIG. 354

much ease as if single acting, or split shed machines were being used. Where tappets are used, the plate or plates which govern the heald staves containing the standing ends, must be so constructed as to give this partial movement to such stave or staves.

Before the methods adopted in designing for Jacquard cross-woven fabrics can be explained, something must be known of the capacity of the machine to do the work demanded by these fabrics, for we may require all, or any portion of an intricate design to be leno, whilst the remaining part or parts may be

anything varying from plain to the most elaborate brocaded effects. This being so, the machine used must be so arranged that it can operate the figuring, the douping, and the easing harnesses; each division being governed by its own part of the machine. Considering that a Jacquard machine may be divided into as many parts as there are kinds of work to do, perhaps the simplest arrangement is where an ordinary single lift machine is supplemented by the addition of extra hooks and needles as illustrated by the sketch Fig. 355, a section of Devogé's arrangement of a Jacquard for leno weaving. Placing this on the loom so that the cards fall off at the back, the two rows of hooks represented by A, and governed by needles 1 and 10, are employed for operating the easer mounting; the rows represented by portion B constitute an ordinary 400 needle single

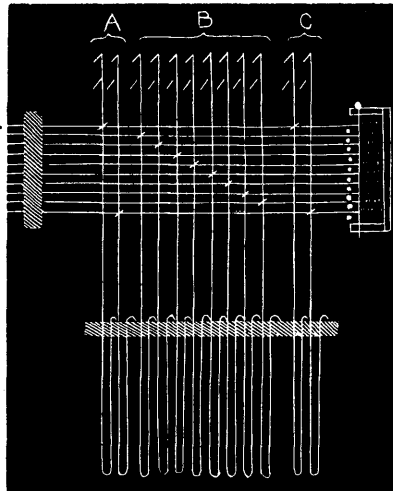

FIG. 355

lift machine, and are made to control the brocade or figuring harness; whilst portion C, governed by the same needles as A, are tied to, and govern the doup mounting. Thus, a 400 is converted into a 600 hook machine, possessing 500 needles, capable of being acted upon by an ordinary 500 card. Connecting these several parts to their respective harnesses, we have an end

view of the whole, at the comber boards, shown by sketch Fig. 356, where A is the easer mounting through which all crossing ends are taken; B, the figuring mounting through which all the threads are taken; c, the doup mounting through which all

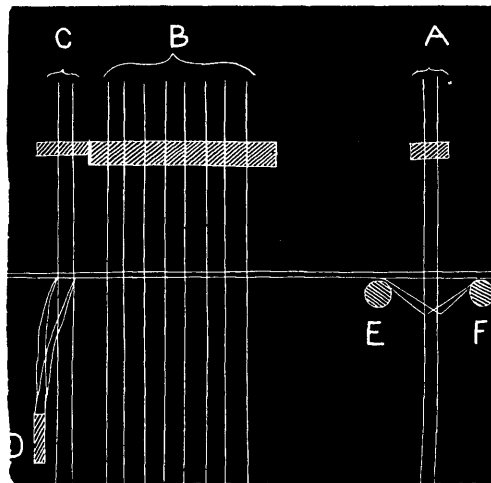

FIG. 356

crossing ends are taken. It will be seen from this disposition of parts, that actuating any douping hook means actuating the corresponding easer, since the same needle commands the two hooks, and that when a cross shed is being formed by any douping hook it is simultaneously eased by its own easer. The other parts shown by this sketch are—D, the stave to which the doups are attached, and E F, two stout rods supporting all yarn taken through the mail eyes of the easer mounting, which is built a full shed below the common level of the other parts. These rods play an important part in the formation of a cross-shed, as by closing or opening them a greater or less degree of easing is imparted to the crossing ends, though in this particular machine this is provided for by an arrangement of griffe bars, which impart a variable lift to the hooks commanding harness A, as compared to those commanding harnesses B C. Making a plan sketch of these mountings, and projecting one row of

holes so as to show a plan of the draft, we see that the whole is an arrangement for crossing two ends round two, drawn of course four ends in a dent; that A in board A eases A in board C, and that B in board A does the same for B in C. In the next row C D of A are easers for C D of C respectively. We also see by this arrangement that any end in the brocade mounting can be lifted by

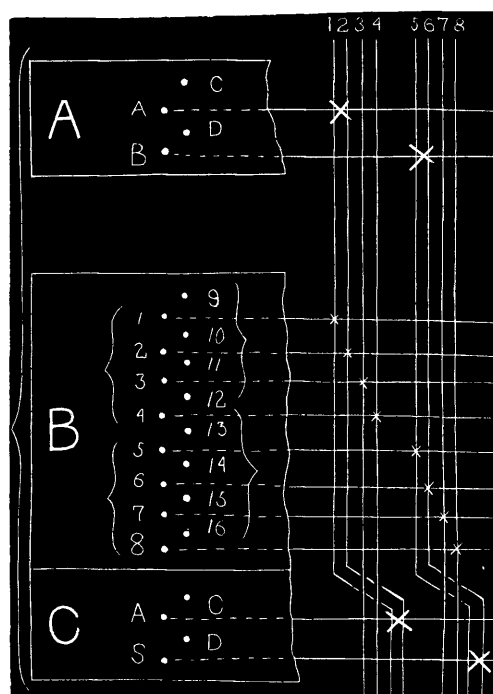

FIG. 357

simply releasing the doups, therefore any figure can be produced up to the extent of the tie, which may have leno in any portion, since any pair of ends may be crossed for any pick of the shuttle. We ought to say here that the end view of mounting, Fig. 356, and the plans at Fig. 357, are common to Jacquard leno work, whatever kind of arrangement of machine is used.

These sketches show, that the whole is an arrangement for crossing two ends about two; that the topmost needle commands

the doup and easer for the first four hooks of the row, the bottom needle the doup and easer for the second four hooks ; and that the card to be used must have a capacity of 10 holes in its width, as shown by Fig. 358, where at A B are a number of holes which would make a cross shed extending over the first thirty-two ends of the warp. But the difficulty is that such holes

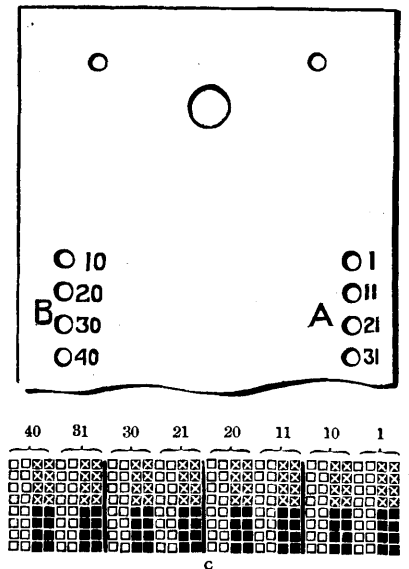

FIG. 358

as these are not—by this arrangement of machine and system of designing—shown in the design ; they are simply indicated by the same marks which indicate a cross shed, the card cutter understanding that if a cross shed is to be made by the first four ends in a bar a hole must be cut at A, if by the second four ends in the bar then at B, which represent the first and tenth needles respectively in each row. This will be apparent from the following :—Let c in the same figure be any portion of a leno design, two ends crossing two, four picks in a crossed, and four in an open shed, the ends crossing from right to left on the paper, the cross sheds being indicated by the crosses. The holes at A B, and marked 1-10, 11-20,

21-30, 31-40, are the holes which would have to be cut for pick marked 1 of the design, the ends of which are bracketed and numbered correspondingly, so as to show the relationship of A B to the design. For the open sheds for picks 5, 6, 7, 8, holes would be cut upon the middle of a card, just as in any ordinary brocade design.

It will thus be seen, that by such indication of what must actually take place to produce a leno fabric by this system, a great economy of time and labour is effected in transferring such designs to point paper. If we were obliged to put on point paper the full card-cutting plan for this, the paper would have to be ruled 10 to the bar warp way, and we should have Fig. 359, where the dots show the action of doups and easers for the four cross sheds. But

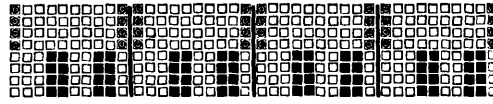

FIG. 359

this figure implies more than it actually shows. Any design of more than eight ends in extent put on point paper in this way would have every eight ends separated from the preceding and succeeding eight—a proceeding which would entail a degree of labour not very easily accomplished by any designer.

We have already said that designs for this class of work may have either ground or figure got up as leno, and that either ground or figure may be plain. But figure may be got up with all kinds of weaves so as to give variety to its several parts, which forces upon us the consideration that, owing to the looseness of such weaves as compared to the tightly gathering together of the picks by the leno, some intermediary weave, such as plain must be employed to come between the one and the other. This keeps the picks on the edges of the figure in their places, and gives the definiteness of outline desired. Let Fig. 360 be any portion of a brocade and leno design. The eight-end satin binding in the portion of figure shown could not possibly keep the picks in position on the edges were it not for the few picks and ends of plain

running around those edges, and though security is thus obtained, care must be taken that no weave used for this purpose shall interfere with the formation of the cross sheds. Here two ends are arranged to cross with two, and we may have one or more picks put in a cross shed, but one such crossing end may not be making

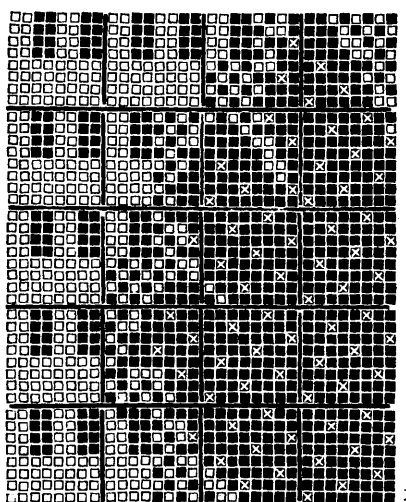

FIG. 360

plain cloth, say, whilst the other is forming a crossed shed, since both are drawn into the same doup; thus there is always a squareness of stepping in the intermediary weave which prevents any interference with the leno weave. This is shown in the example given. Fig. 361 is a portion of a card for the first pick of Fig. 360, which will materially help the student, if compared with the other illustrations, to a better comprehension of the details of this system of weaving and designing.

There is another machine in use for leno weaving very similar to that shown at Fig. 355, but which has the douping and easing needles arranged as the ninth and tenth in each row, not the first and tenth as in the machine under consideration.

Perhaps a mounting governed by an ordinary single lift Jacquard machine, with the cards falling off at the side, imposes the greatest

modifications in designing for lenos. In this case the machine is placed upon the loom with its long side parallel to the short side of the comber board. The total hooks in the machine are divided into

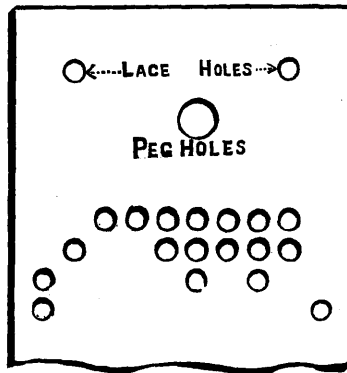

FIG. 361

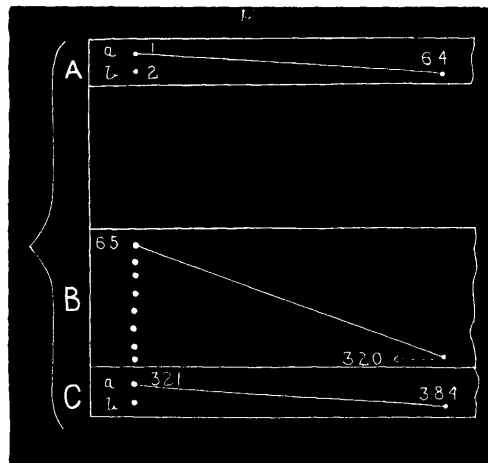

FIG. 362

three parts as required by the exigencies of the leno to be made— one part each to the doup, the brocade, and the easer mountings

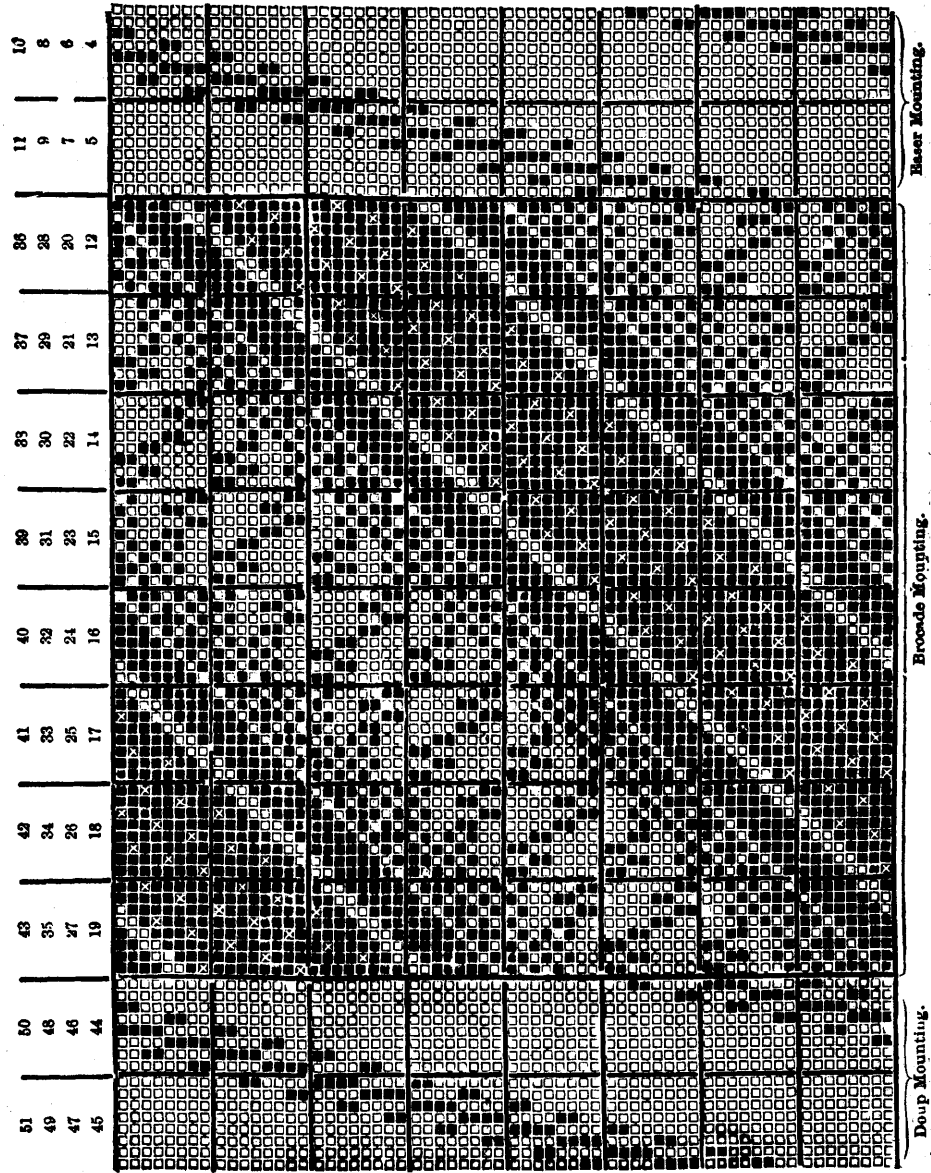

FIG. 363

respectively. The harnesses are often arranged for two ends to cross two, and as there are as many hooks taken at one end of the machine for the doup, as there are at the opposite end for the easer mounting, it follows that the capacity of the machine for figuring purposes is cut down one-quarter; this will be apparent from Fig. 362, a sketch plan of a straight tie, for such a machine as we are considering, where *A B C* show the relative positions of the several comber boards. But this sketch also shows that hooks 1-64 govern the easer mounting; hooks 65-320 the brocade mounting, and hooks 321-384 the doup mounting; from which we see that out of the whole 384 hooks tied up there are only 256 that may be engaged for figuring purposes. In Fig. 361, 10 needles govern 12 hooks, but in this one 12 needles are required for 12 hooks, but the figuring capacity is the same in both. The drafting here is exactly the same as in the last example—*a* in easer mounting *A*, eases *a* in doup mounting *c*; *b* in *A* eases *b* in *c*, and so on for every other row. Fig. 363 shows the method of designing for this particular form of mounting. Since a doup and an easer are required for every four ends of the design, which is arranged for two ends crossing two, sixty-four ends to the repeat, then we shall require sixteen of each. These are shown in the first two and last two bars of the design, No. 1 in bar 4 easing No. 1 doup in bar 44, and so on correspondingly. The numbering of the bars for the card cutter is shown at the top of the design—4-11 are for easers; 12-43 for the brocade; 44-51 for the doup mounting, the whole arranged for a 400 machine, of which only 384 hooks are tied up.

An ordinary machine may be used for a mounting in which the cards fall over the back, front, or sides of the loom, but with a machine such as Fig. 361, it is essential that they fall either at the back or front.

In designing for the top doup arrangement of mounting, the designer has the same conditions imposed as when dealing with stave work. The stave containing the doup healds is fastened to the front of the comber-board frame; the healds hang down immediately in front of the doup mails into which they are threaded; the crossing ends lie over the standing ones; and the cross and open

sheds are made oppositely to those of a bottom doup. Sketch Fig. 364 shows the general arrangement of parts for effecting this work, one pair of crossing, and their accompanying standing ends only being shown. As the method of forming the cross and open sheds is exactly the same here as in top doup stave work, the example given—Fig. 365—will need little or no explanation, only that the threads cross from right to left on the design paper, that the cross sheds are formed by lifting standing and crossing ends together, leaving standard and doup down, and that the open sheds are made by lifting the standing ends.

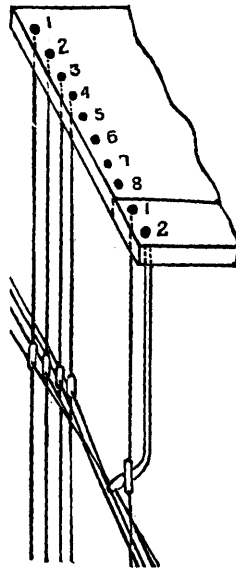

FIG. 364

Indian muslin is a pure gauze cloth ornamented with extra weft, the object being to produce a heavy figure on a light open work ground, which, by contrast, becomes very pronounced. A stave of doup healds is placed in front of a Jacquard harness, the whole warp being drafted one end crossing one, two ends in a dent. The figuring shed is formed by lifting the standing ends only, whilst the ground picks are inserted in sheds formed by alternately lifting the crossing

ends in the open and crossed positions. Let A, Fig. 366, be any portion of a design, occupying only twenty ends as a figure motive, but in reality, forty ends when put upon point paper, since it can

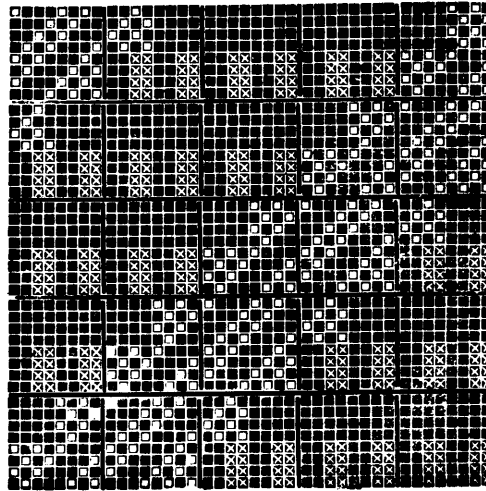

FIG. 365

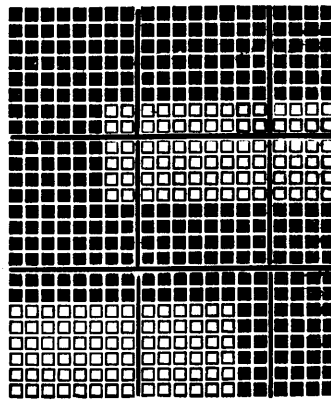

FIG. 366

only be produced by standing ends. Marking off—by indicating bars running up the side of the design—the various kinds of sheds formed

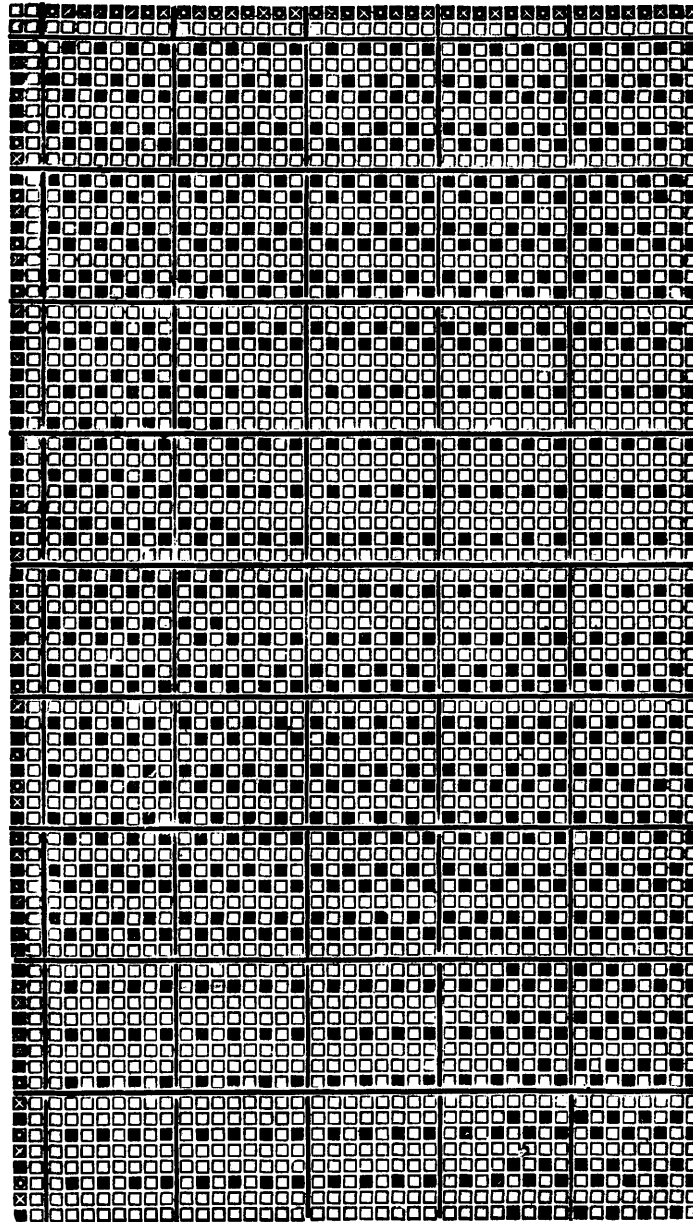

FIG. 366

thus:—■ figuring, ☒ cross, and ☐ open shed, as well as the crossing ☒ and standing ☐ ends, proceed to put the figure motive on standing ends and figuring picks, then make the shed marked ☒ by lifting the doup heald, and lastly lift all the crossing ends in the open shed, and we have B 366, which is the full card-cutting plan for A. The standard and doup may be tied up to spare hooks in the machine, and so come within the compass of the card, in which case their action will be marked upon the sides of the design in the bars corresponding to the rows to which they are tied.

Though so simple a fabric as regards its construction, it lends itself very readily to ornamentation, particularly when several coloured wefts are employed in producing the figure. For this purpose several shades of any colour, may be used, preferably, of course, low in tone and wanting the assertiveness of primary colours. But when such wefts are employed, the junction of any two must be so arranged that they shall overlap each other to the extent of two or more warp threads, for if there was no overlapping, it is obvious that every line would present a break to the continuity of the figure. Fig. 367 will illustrate this peculiarity of structure, where picks 3,

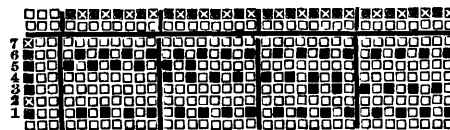
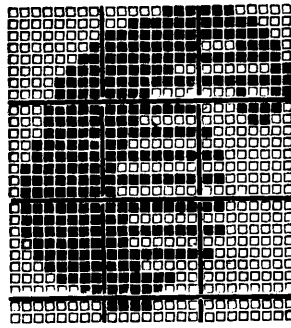
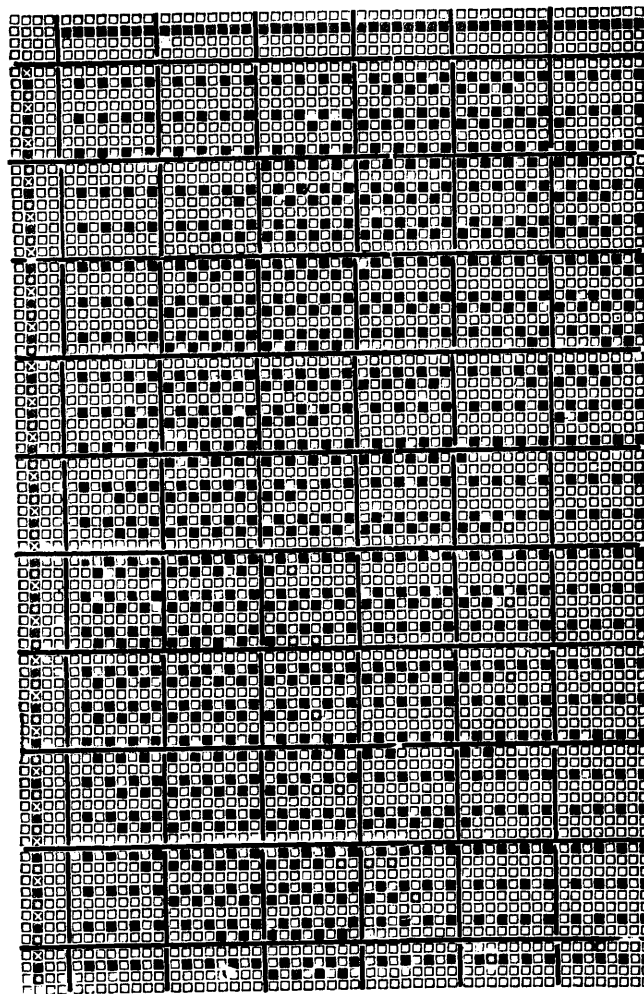

FIG. 367

4, 5 are three figuring picks of any design woven by this method. Another feature in the designing of these fabrics is, that a certain amount of “shading” can be imparted to any portion of the design by simply reducing to one-third or one-half, the number of the figuring picks that are put in the other parts of the figure. Let A, Fig. 368, be the figure motive, the part with half the picks painted to be the shaded portion. Transferring this to point paper, the full card-cutting plan will be represented by B in the same figure, which will illustrate the method pursued in producing these effects. A low count of reed must be used, and the warp and ground weft yarns, are generally comparatively five in count, whilst the figuring



A



B

FIG. 368

weft must be of a coarse character, and have very little twist in it. A very beautiful effect may be obtained in a modification of this system by using chenille wefts for figure production, the resulting abric having the appearance of a pile figure on a light open work ground.

There are several other modifications of cross-weaving for special purposes, notably the douping of centre selvages when two or more fabrics are woven in one width, and the low grade cloths woven on the needle loom, but these are merely mechanical effects, whilst the utility of the full cross leno, and douping in front of the reed, is so questionable, that they are probably not worth the trouble and cost of production, except as curious examples of the weaver's art.

FINIS.

INDEX

	PAGE
Advantages of the Lancashire lappet motion - - - - -	108
Alhambras - - - - -	95, 98
Arrangement of healds for warp spots - - - - -	92
Arrangement of extra weft spots on design paper - - - - -	86
Arrangement of spots - - - - -	75
Backed and double cloth - - - - -	158
Backed fabrics—Warp - - - - -	160
Backed fabrics—Weft - - - - -	158
Bedford cords—Plain and twill - - - - -	124
Bedford cords - - - - -	124
Bordered diapers - - - - -	72
Bottom doup heald harness for gauge - - - - -	194
Binding of extra warp spots - - - - -	91
Broken twills - - - - -	49
Broken twills—Rule for finding repeat in - - - - -	51
Brussels carpets - - - - -	153
Brussels carpet bobbins—Weighting of - - - - -	155
Calculations for heald knitting - - - - -	31
Canvas cloth - - - - -	118
Card cutting for Jacquard gauze - - - - -	216
Carpets—Brussels - - - - -	153
Carpets—Chenille - - - - -	157
Carpets—Kidderminster - - - - -	176
Carpets—Tapestry - - - - -	150
Carpets—Wilton - - - - -	156
Check diapers - - - - -	43
Chenille carpets - - - - -	157
Colouring of plain cloth - - - - -	27
Colours for design paper - - - - -	16
Combined cut and uncut fabrics - - - - -	145
Combined twills - - - - -	47
Compound drafts - - - - -	62
Compound figuring—Mounting for - - - - -	98
Condensed pattern draft and tie-up for diapers - - - - -	68
Construction—Design of - - - - -	I

	PAGE
Construction of lappet wheels - - - - -	106
Contraction in weaving—Percentage of - - - - -	22
Cords—Bedford - - - - -	124
Cords and corded effects - - - - -	121
Cords—Double - - - - -	131
Cords—Pile - - - - -	129
Cords—Warp and weft - - - - -	25
Corkscrew twills - - - - -	51
Counts of threads - - - - -	18
Cross weaving - - - - -	12, 193
Curved twills - - - - -	54
Cut and uncut fabrics—Combined - - - - -	145
Cut and uncut pile—Designing and card cutting for - - - - -	145
Cut pile with wires - - - - -	142
Denting for open work effects - - - - -	118
Designing and card cutting for cut and uncut pile - - - - -	145
Designing for Indian muslin - - - - -	223
Designing for repps - - - - -	123
Designing for top doup Jacquard gauze - - - - -	221
Design of construction - - - - -	1
Design of ornamentation - - - - -	1
Design paper and its uses - - - - -	14
Design paper—Colours for - - - - -	16
Design paper for double cloth - - - - -	15
Devogés gauze Jacquard machine - - - - -	213
Dhootie borders - - - - -	94
Diameters of threads - - - - -	18, 22
Diapers—Bordered - - - - -	72
Diaper checks - - - - -	43
Diapers— Condensed pattern, draft, and tie-up, for - - - - -	68
Diapers—Twill and satin - - - - -	68
Direction of twist in threads - - - - -	19
Double cloth—Design paper for - - - - -	15
Double cords - - - - -	131
Double cloth weaving - - - - -	10
Double warp pile fabrics - - - - -	148
Double satins - - - - -	38
Double width fabric - - - - -	165
Double unequal fabric - - - - -	163
Doup heald harness—Top - - - - -	199
Doup heald harness—Bottom - - - - -	194
Drafting - - - - -	58

	PAGE
Drafts and ties for gauge heald work - - - - -	206
Drafts and tie-ups - - - - -	58
Drafts—Compound - - - - -	62
Drafts—Mixed - - - - -	61
Drafts—Skip - - - - -	60
Draft plan of Jacquard gauze harness - - - - -	214
Driving of lappet wheel - - - - -	104
Easing bar - - - - -	198
Elementary principles of fabric structure - - - - -	5
Equal fabrics stitched together - - - - -	166
Extra warp—Figuring with - - - - -	95
Extra warp—Mounting for figuring with - - - - -	97
Extra warp—Spotting with - - - - -	89
Extra warp spots—Binding of - - - - -	91
Extra weft—Spotting with - - - - -	81
Fabrics—Proportioning of - - - - -	55
Fabric structure—Principles of - - - - -	5
Fancy patterns made with one doup - - - - -	202
Fancy twills - - - - -	40
Faults of the Lancashire lappet motion - - - - -	107
Figured terry fabrics - - - - -	139
Figure weaving - - - - -	7
Figured weft velvets - - - - -	134
Figuring with extra warp - - - - -	95
Galloway's lappet motion - - - - -	110
Galloway's motion—Pegging the lattice of - - - - -	115
Gauze patterns formed by reversing draft - - - - -	204
Gauze Jacquard machine—Devogés - - - - -	213
Gauze on design paper—Method of showing - - - - -	209
Gauze weaving—Jacquard - - - - -	212
Gauze weaving—Ordinary Jacquard used for - - - - -	218
Gauze weaving—Shakers for - - - - -	211
Granite patterns - - - - -	40
Hand-loom tie-ups - - - - -	64
Harness for Indian muslin - - - - -	222
Harness—Jacquard gauze - - - - -	214
Harness for Kidderminster carpets - - - - -	179
Harness for tapestry - - - - -	186, 189
Harness for toileting - - - - -	173
Healds—Arrangement of; for warp spots - - - - -	92

	PAGE
Heald harness for gauze—Bottom doup	194
Heald harness for gauze—Top doup	199
Heald knitting—Calculations for	31
Honeycomb	120
Horizontal motion of lappet needle-frame	103
Huckabacks	120
Introduction	1
Indiun muslin	222
Jacquard gauze—Card cutting for	216
Jacquard gauze harness	214
Jacquard gauze weaving	212
Jacquard gauze design—Preparing of	217
Jacquard used for gauze weaving—Ordinary	218
Kidderminster carpet	176
Kidderminster carpet harness	179
Kidderminster carpet machine	182
Lancashire lappet motion	101
Lancashire lappet motion—Advantages of the	108
Lancashire lappet motion—Faults of the	107
Lappet motion—Galloway's	110
Lappet motion—Lancashire	101
Lappet patterns	105
Lappet weaving	101
Lappet wheels—Construction of	106
Lappet wheel—Driving of	104
Lenos—Mock	119
Method of designing for gauze with cards over the side	221
Method of designing for gauze woven with a special machine	216
Method of showing gauze on design paper	209
Mixed drafts	61
Mock lenos	119
Modifications of cross weaving	227
Mounting for compound figuring	98
Mounting for figuring with extra warp	97
Needle-frame—Horizontal motion of lappet	103
Open work effects	117
Open work effects—Denting for	118
Ordinary Jacquard machine used for gauze weaving	218

	PAGE
Ornamentation—Design of - - - - -	1
Ornamentation of plain cloth - - - - -	21
Pegging the lattice of Galloway's motion - - - - -	115
Percentage of contraction in weaving - - - - -	22
Pile cords - - - - -	129
Pile knives - - - - -	143
Pile weaving - - - - -	8, 129
Pin and needle-frames—Vertical motion of lappet - - - - -	103
Piqué fabrics - - - - -	167
Placing two twills side by side - - - - -	46
Plain and twill Bedford cords - - - - -	124
Plain cloth - - - - -	5
Plain cloth—Ornamentation of - - - - -	21
Plain cloth ornamented by colour - - - - -	27
Plain cloth ornamented by "cramming" - - - - -	31
Ply fabrics—Three or more - - - - -	165
Preparing Jacquard gauze designs - - - - -	217
Principles of fabric structure - - - - -	5
Proportioning of fabrics - - - - -	55
Proportioning of fabrics—Rules for - - - - -	56
Regular twills - - - - -	35
Repps - - - - -	121
Repps—Designing for - - - - -	123
Reversing direction of twills - - - - -	40
Reversing draft—Gauze patterns formed by - - - - -	204
Reversing the order of interlacing in twills - - - - -	42
Running one pattern between the diagonal ribs of another - - - - -	45
Rules for constructing satins - - - - -	36
Rule for finding repeat in broken twills - - - - -	51
Rule for making steep and reclining twills - - - - -	44
Rules for proportioning fabrics - - - - -	56
Satin arrangement of twills - - - - -	48
Satins—Double - - - - -	38
Satins or broken twills - - - - -	35
Satins—Perfect and imperfect - - - - -	37
Satins—Rules for constructing - - - - -	36
Shakers for gauze weaving - - - - -	211
Skip drafts - - - - -	60
Skip twills - - - - -	50
Spots—Arrangement of - - - - -	75
Spots in plain order - - - - -	76

	PAGE
Spots in satin order - - - - -	78
Spots in twill order - - - - -	77
Spots—Swivel - - - - -	87
Spotting - - - - -	75
Spotting with extra warp - - - - -	89
Spotting with extra weft - - - - -	81
Steep and reclining twills - - - - -	43
Steep and reclining twills—Rule for making - - - - -	44
Stitching equal fabrics together - - - - -	166
Swivel rack - - - - -	88
Swivel spots - - - - -	87
Tapestry carpets - - - - -	150
Tapestry fabrics - - - - -	183
Tapestry harness - - - - -	186, 189
Terry fabrics—Figured - - - - -	139
Terry towelling - - - - -	136
Terry woven with wires - - - - -	140
Textile threads - - - - -	17
Threads—Counts of - - - - -	18
Threads—Diameters of - - - - -	18, 22
Threads—Direction of twist in - - - - -	19
Threads of varying thickness - - - - -	25
Threads—Textile - - - - -	17
Three or more ply fabrics - - - - -	165
Tie-ups - - - - -	63
Tie-ups—Hand-loom - - - - -	64
Toileting harness - - - - -	173
Toiletings made with healds - - - - -	170
Toiletings made with Jacquard - - - - -	172
Top doup heald harness for gauze - - - - -	199
Trevette - - - - -	144
Twilling - - - - -	34
Twill and satin diapers - - - - -	68
Twills arranged in satin order - - - - -	48
Twills—Broken - - - - -	49
Twills—Broken or satin - - - - -	35
Twills—Combined - - - - -	47
Twills—Corkscrew - - - - -	51
Twills—Curved - - - - -	54
Twills—Fancy - - - - -	40
Twills—One point of reversion longer than another - - - - -	41
Twills—Skip - - - - -	50

	PAGE
Twills—Steep and reclining - - - - -	43
Twills—Two placed side by side - - - - -	46
Twills—Regular - - - - -	35
Twills—Reversing direction of - - - - -	40
Tubular cloth - - - - -	164
Two separate fabrics in one loom - - - - -	164
Uses of design paper - - - - -	14
Velvets—Weft - - - - -	132
Vertical motion of lappet pin and needle-frames - - - - -	103
Warp and weft cords - - - - -	25
Warp-backed fabrics - - - - -	160
Warp pile fabrics - - - - -	136
Warp pile fabrics—Double - - - - -	148
Weft-backed fabrics - - - - -	158
Weft pile fabrics - - - - -	129
Weft velvets - - - - -	132
Weft velvets—Figured - - - - -	134
Weighting of Brussels carpet bobbins - - - - -	155
Wilton carpets - - - - -	156

MANCHESTER:
MARSDEN AND CO. LTD., PRINTERS, CARR STREET