

# Die Deutsche Webschule.

Enthaltend:

## die Theorie, Technik und Praxis der Weberei.

Für Fabrikant und Weber

bearbeitet

von

**G. Hermann Oelsner,**

zuletzt erster Lehrer an der Webschule zu Hohenstein bei Chemnitz.

Zweite Auflage.

Mit 136 lithographirten Tafeln.

Preis 3 Thaler.

Verane.

Verlag von Anton Send.

1869.

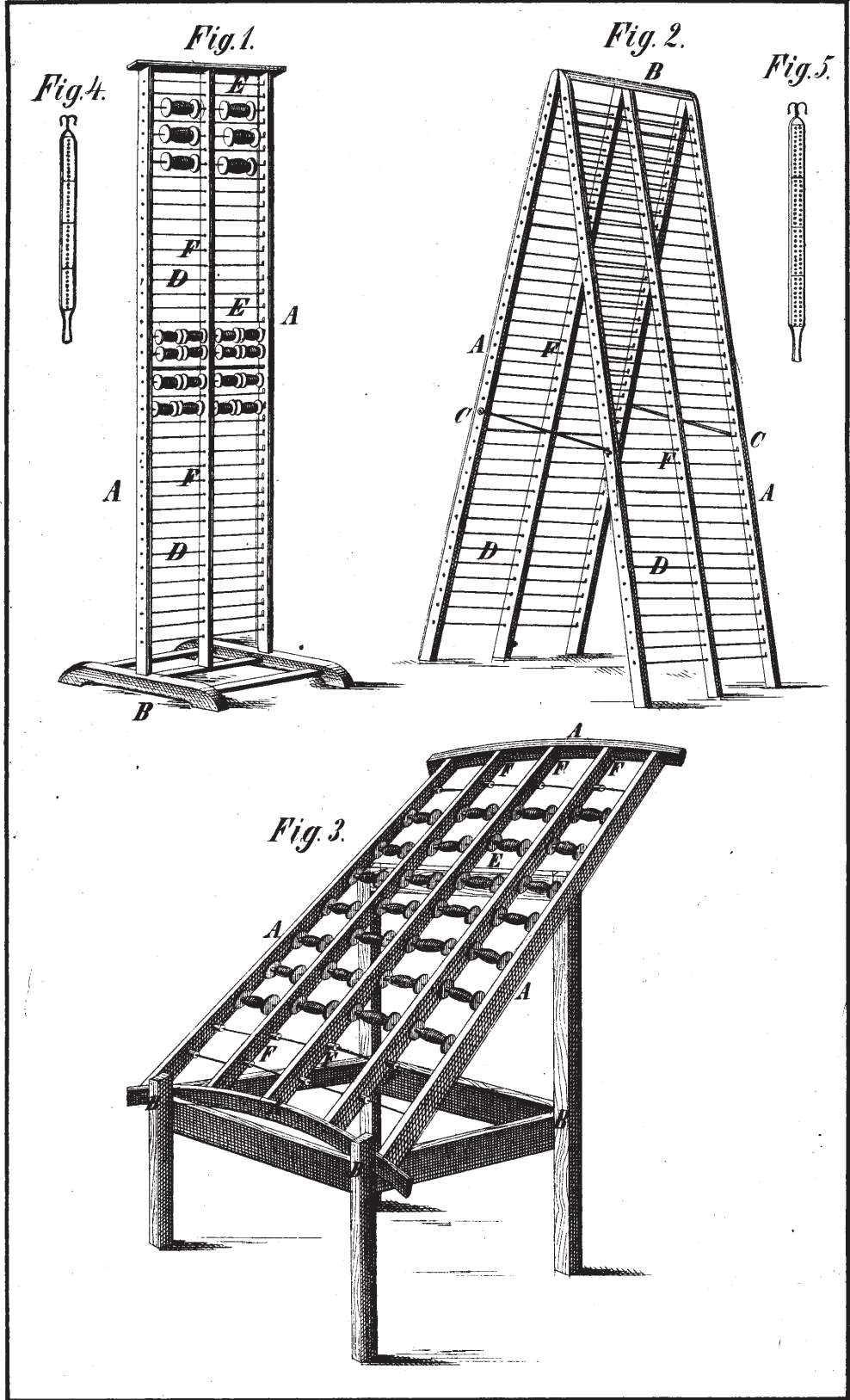

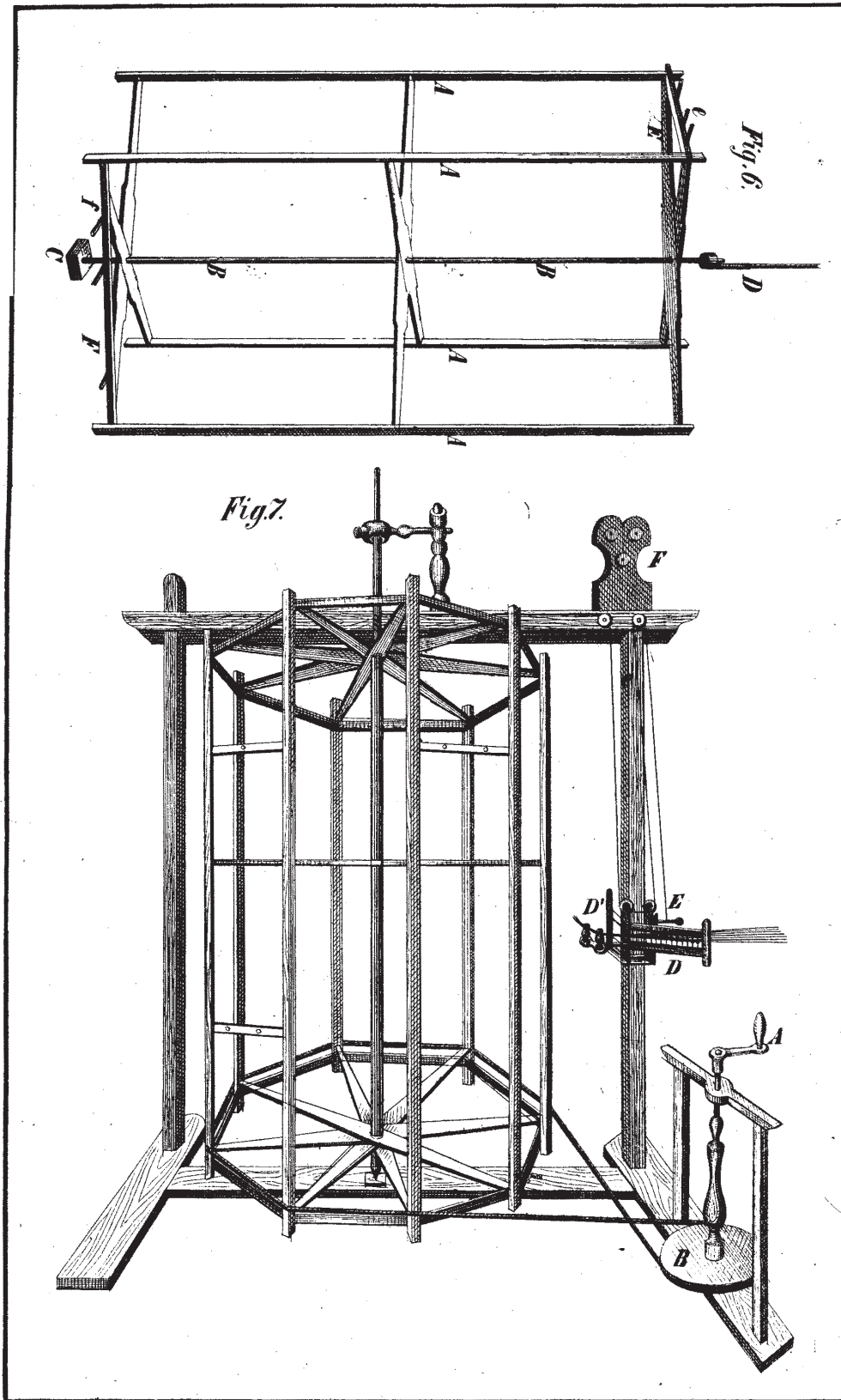

Taf.3.

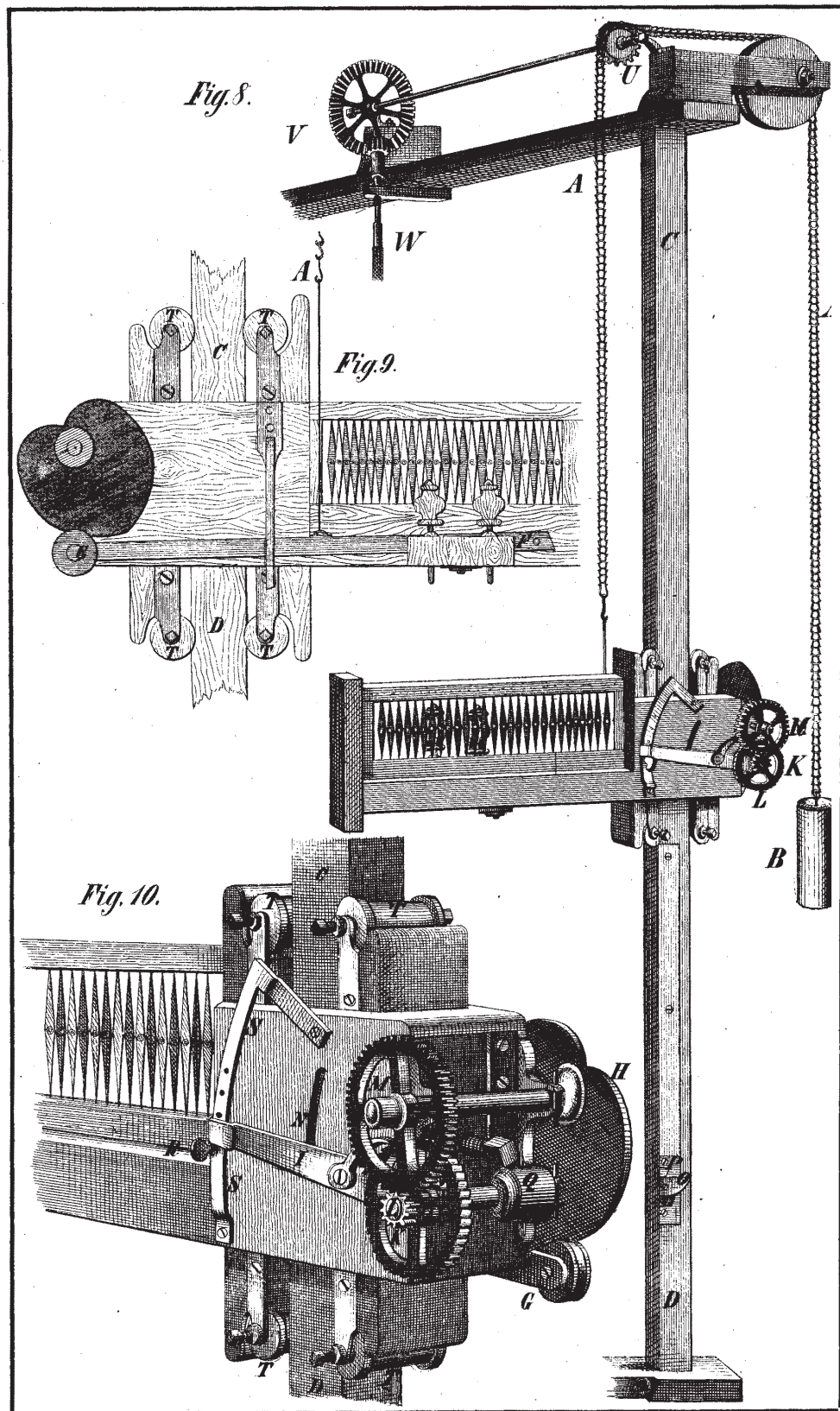

Taf.4.

Fig.11.

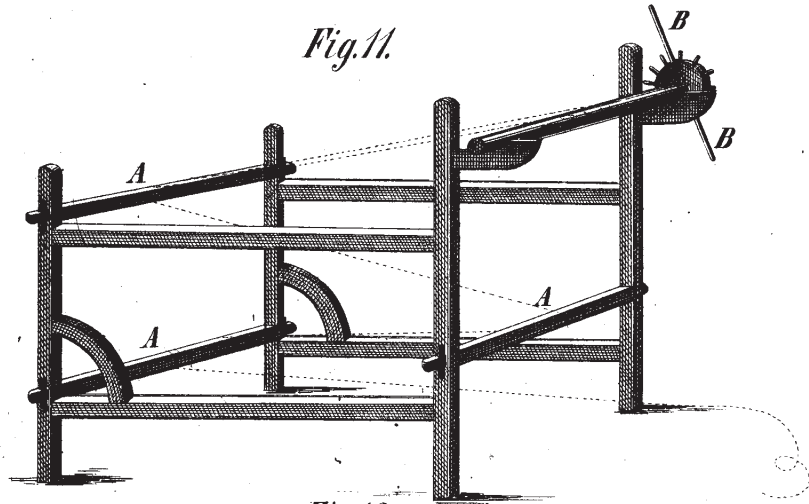
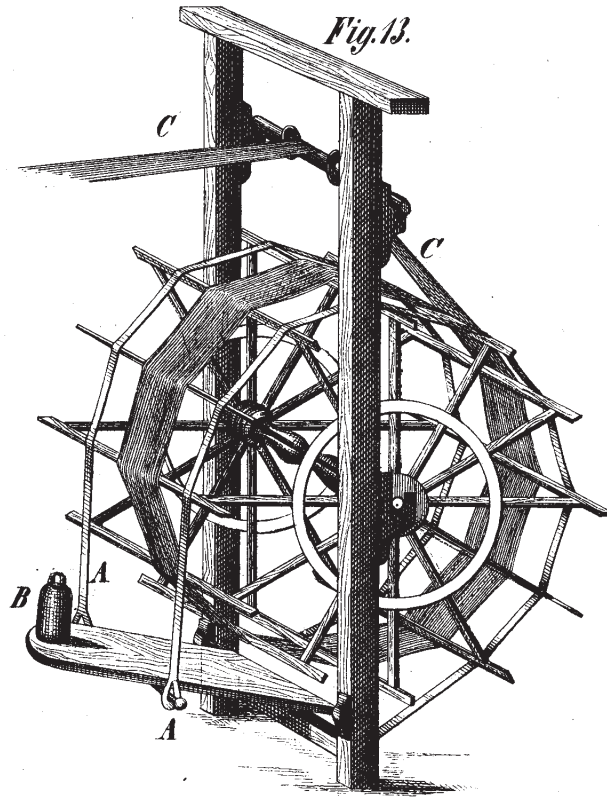

Fig.12.



Fig.13.



Taf. 5.

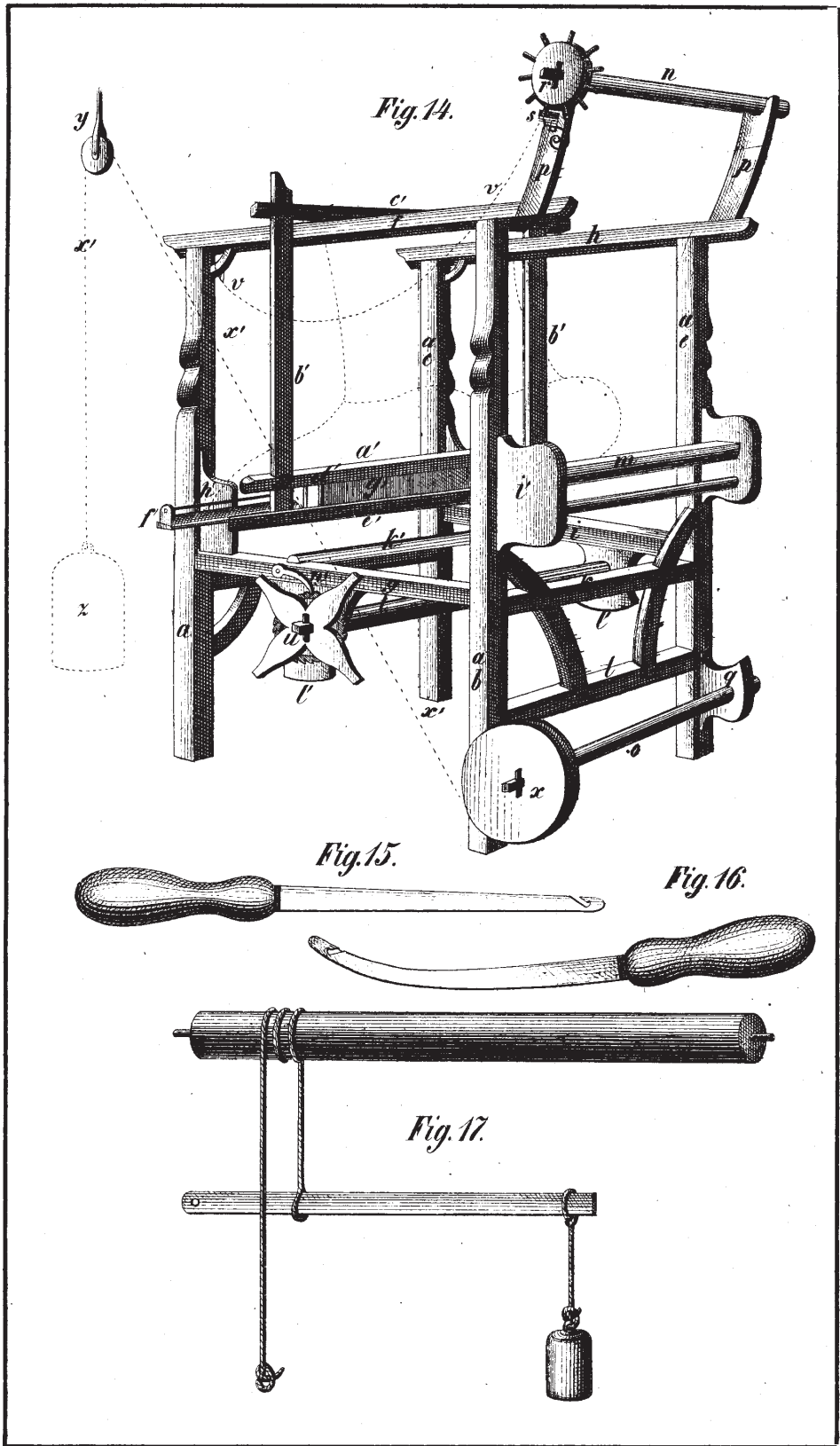

Taf.6.

Fig. 18.

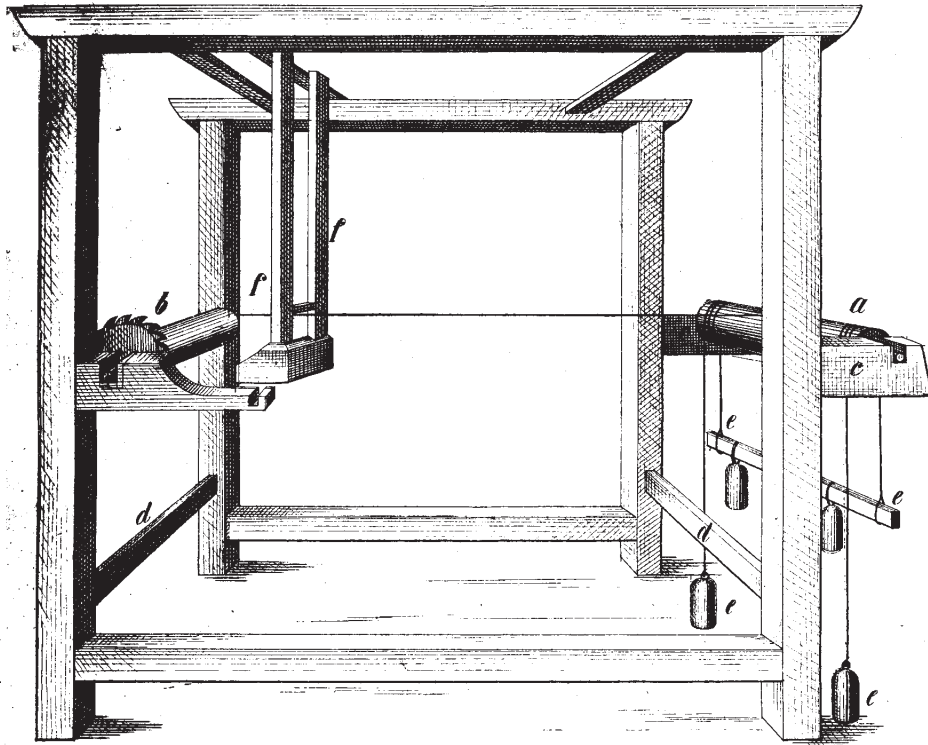

Fig. 19.

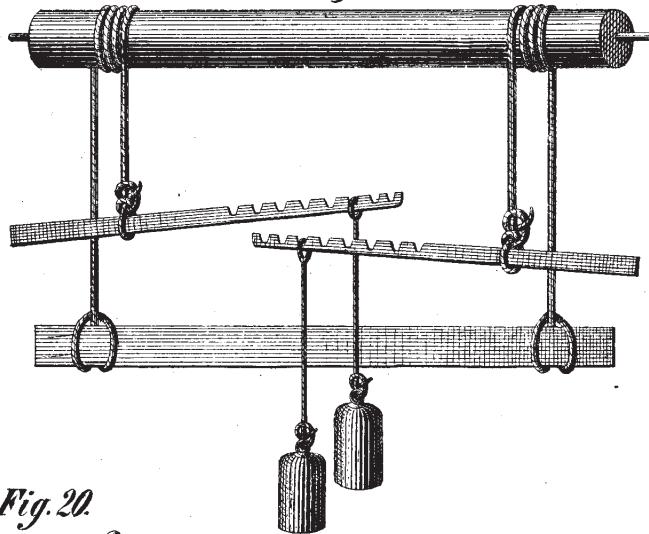

Fig. 20.

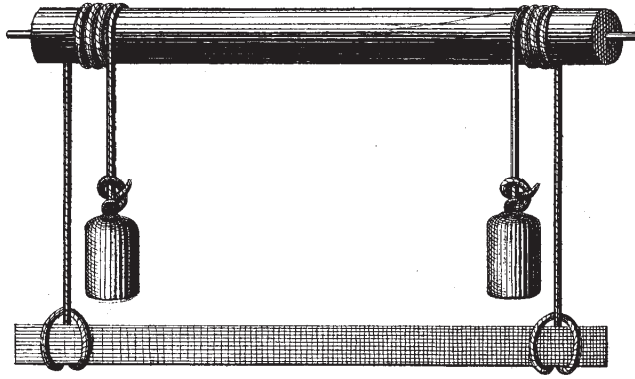

Fig. 21.



Taf.7.

*Fig.22.*



*Fig.23.*

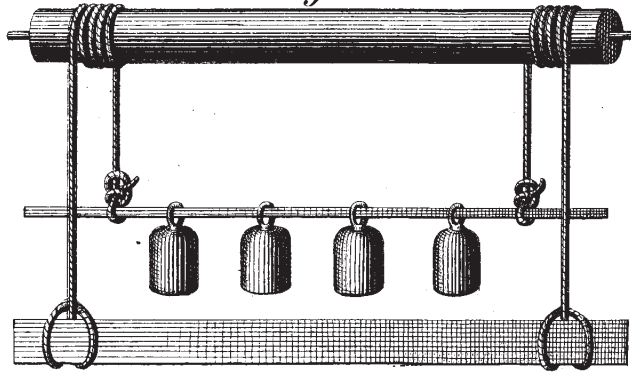

*Fig.24.*

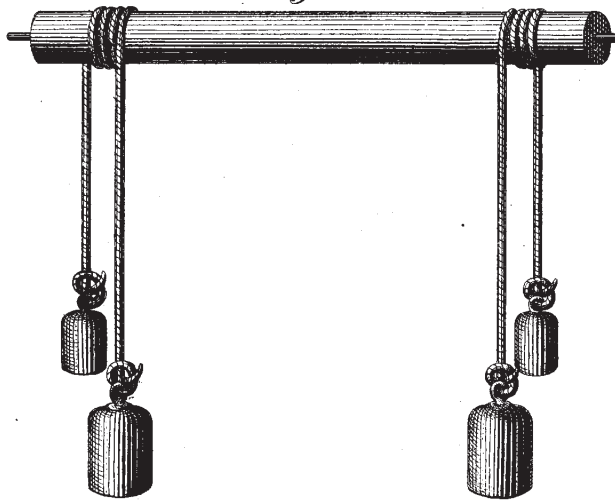



Taf.8.

Fig.25.

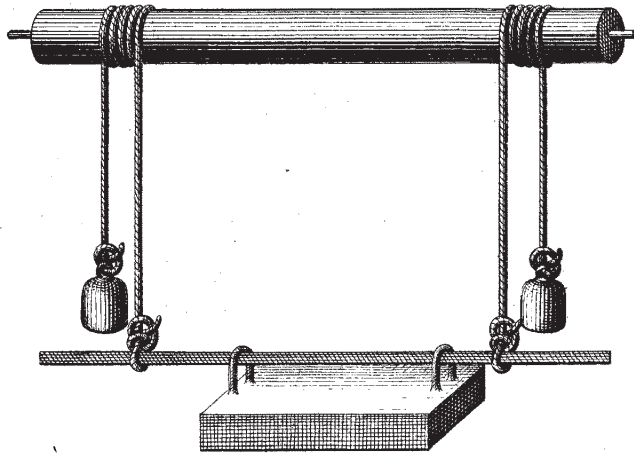

Fig.26.

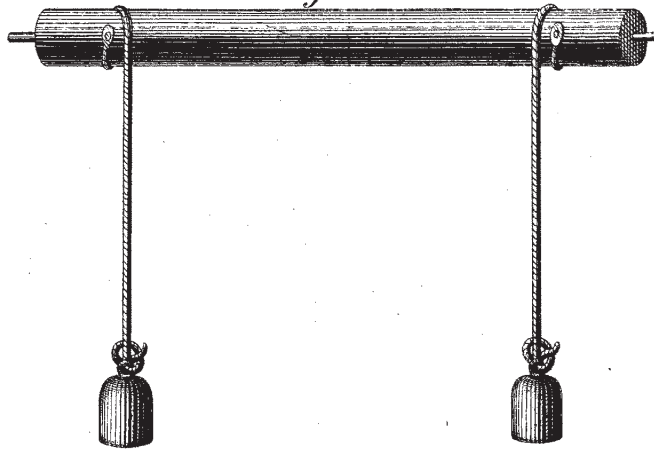

Fig.27.

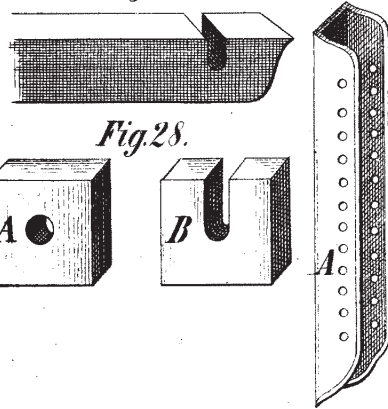

Fig.28.

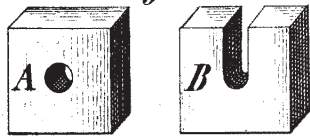

Fig.29

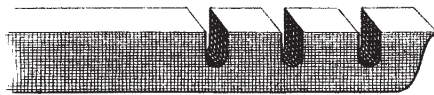
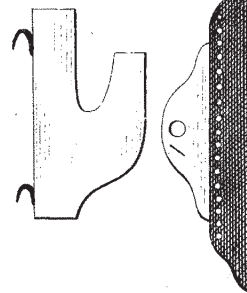

Fig.30.



Fig.31. Fig.32.



# Taf.9.

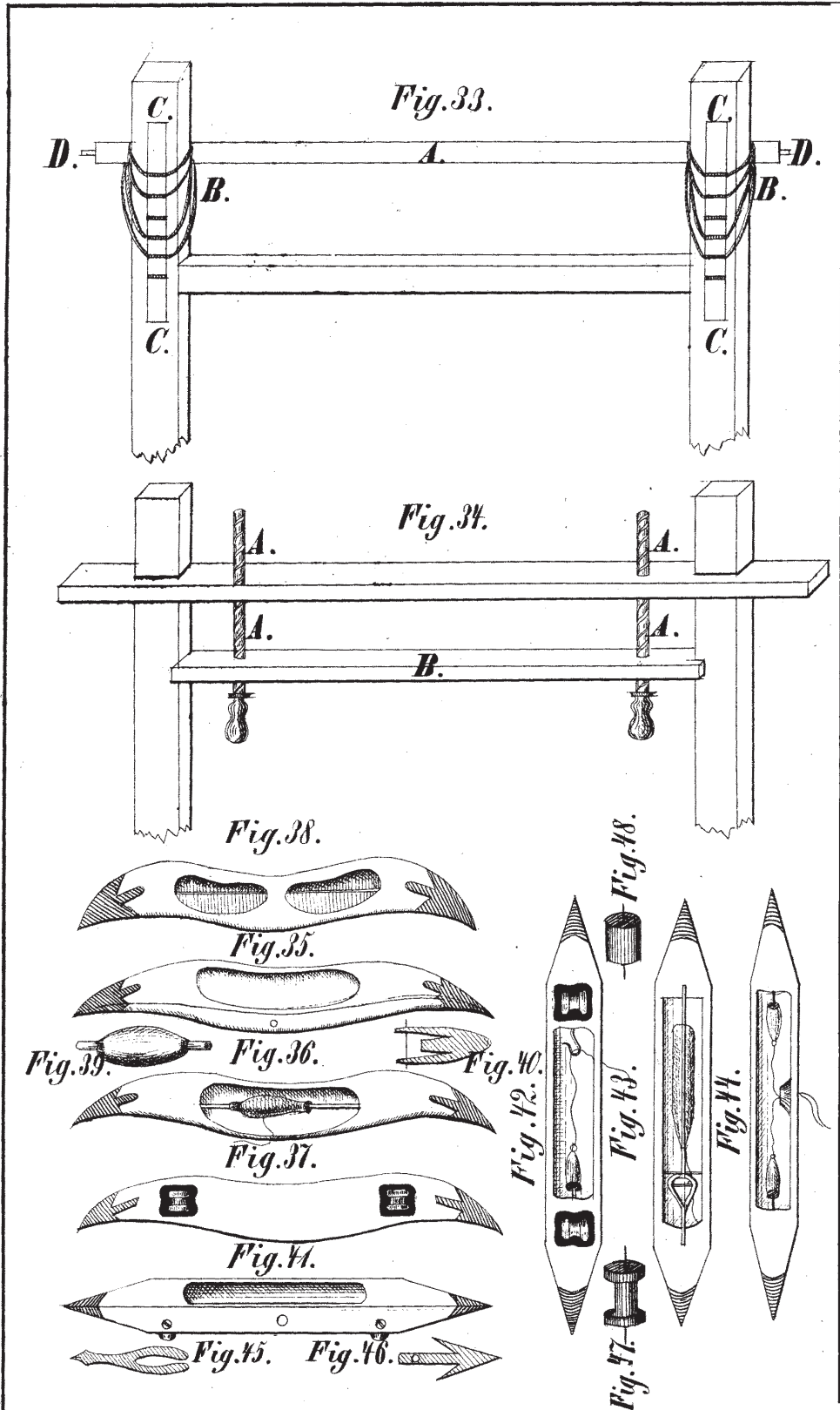

Taf.10.

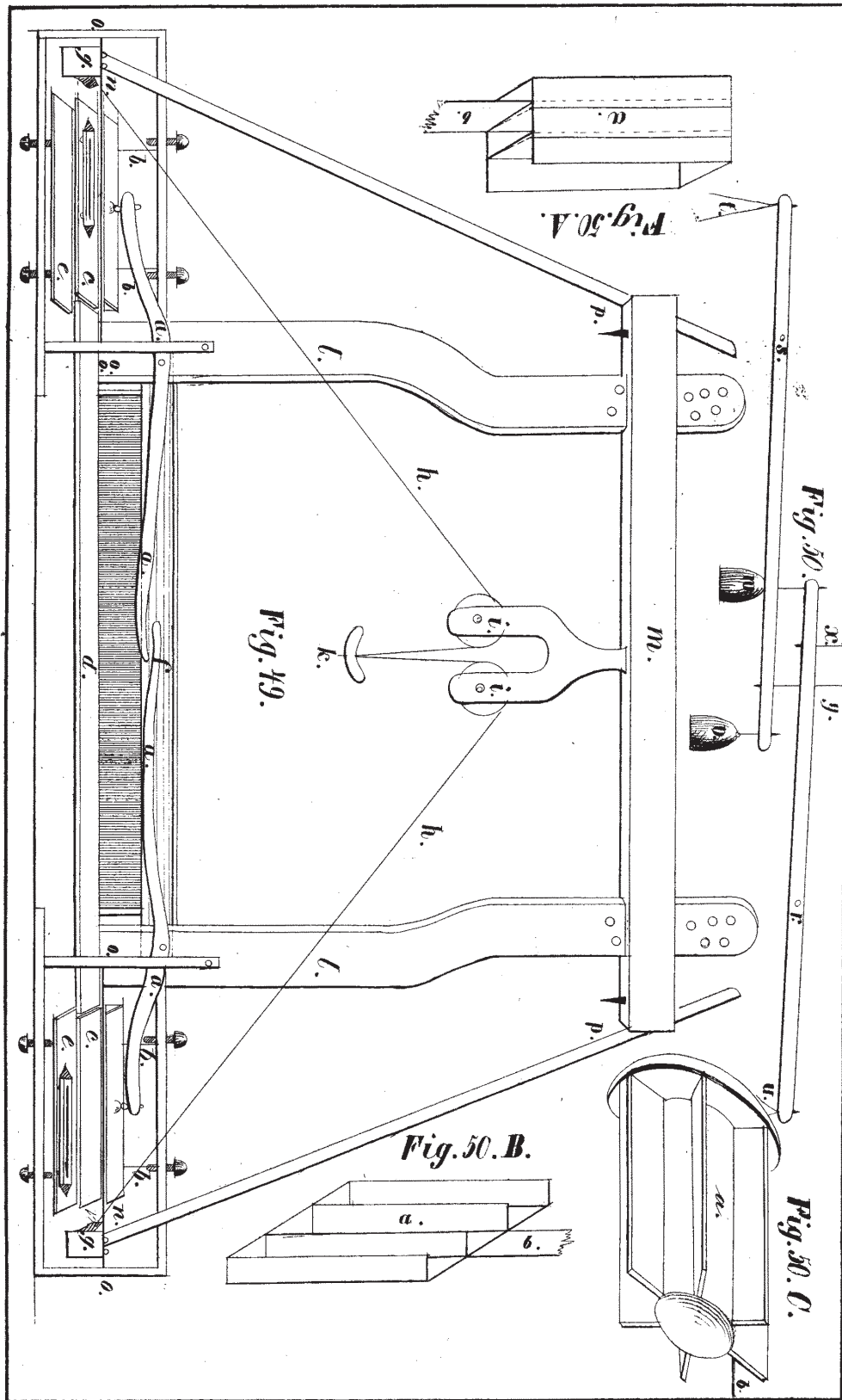

# Taf. II.

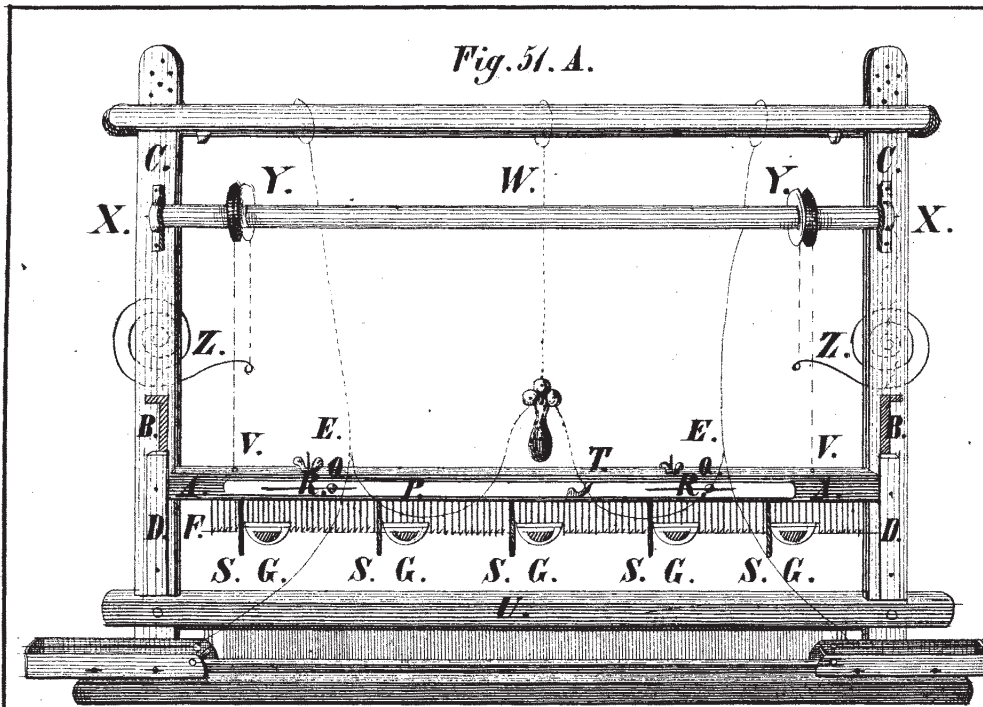

*Fig. 51. B.*

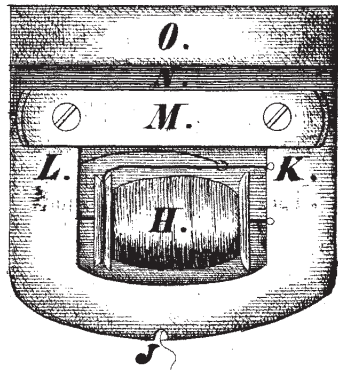

*Fig. 52. B.*

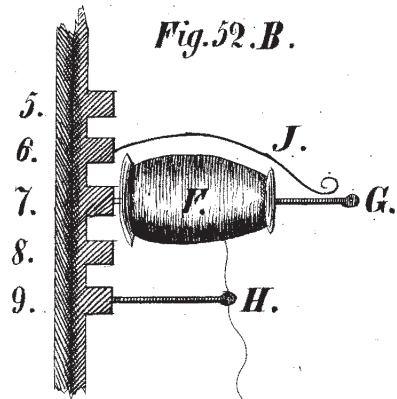

*Fig. 52. A.*

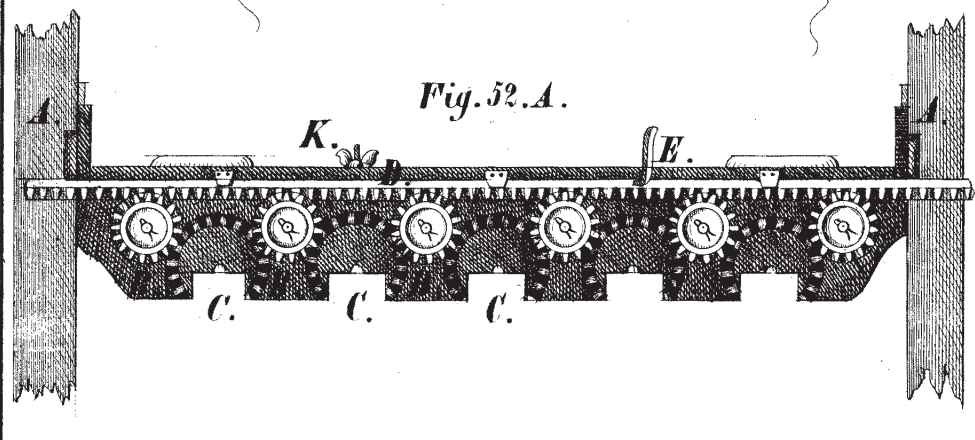

Taf. 12.

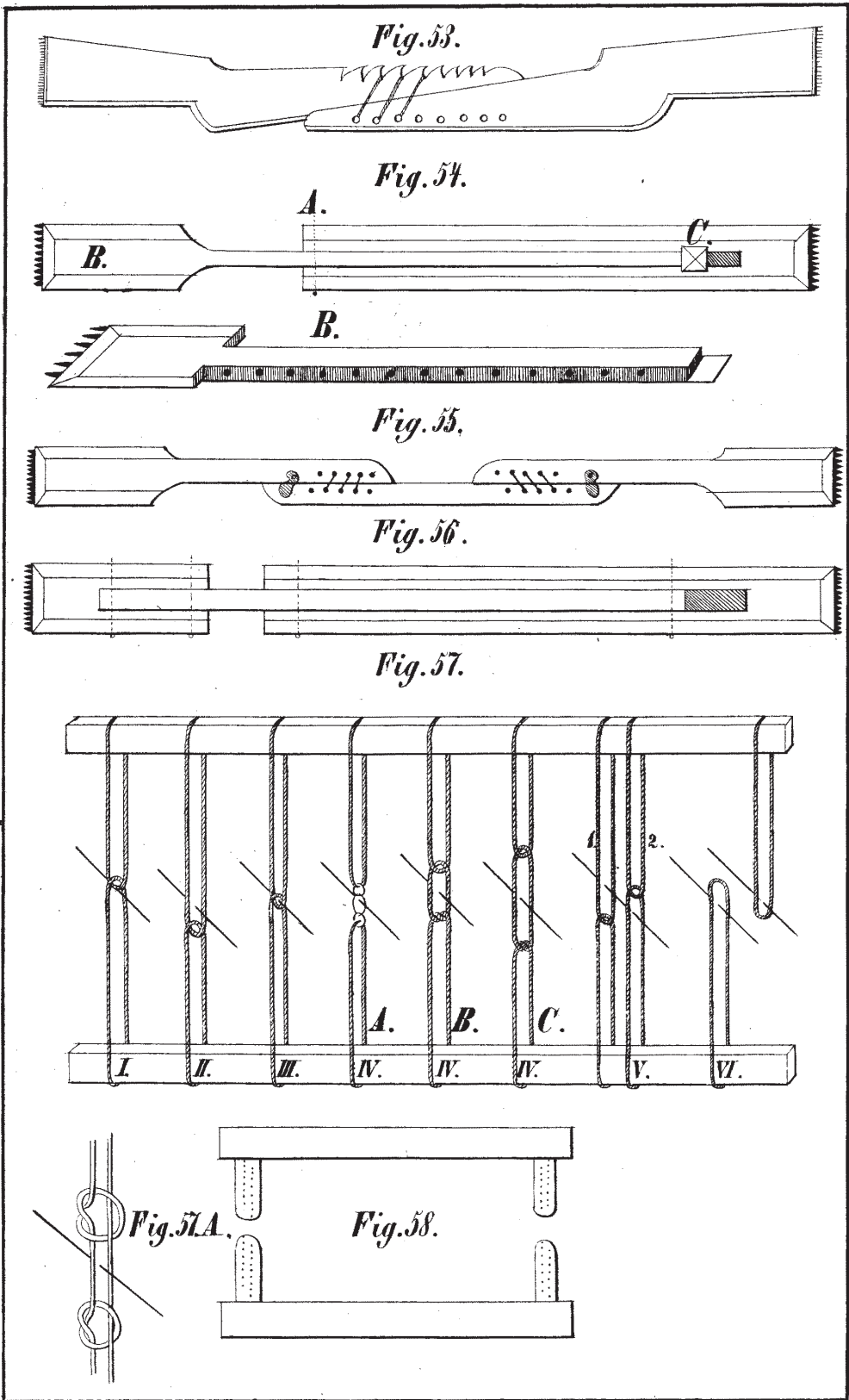

Taf. 13.

Fig. 59.

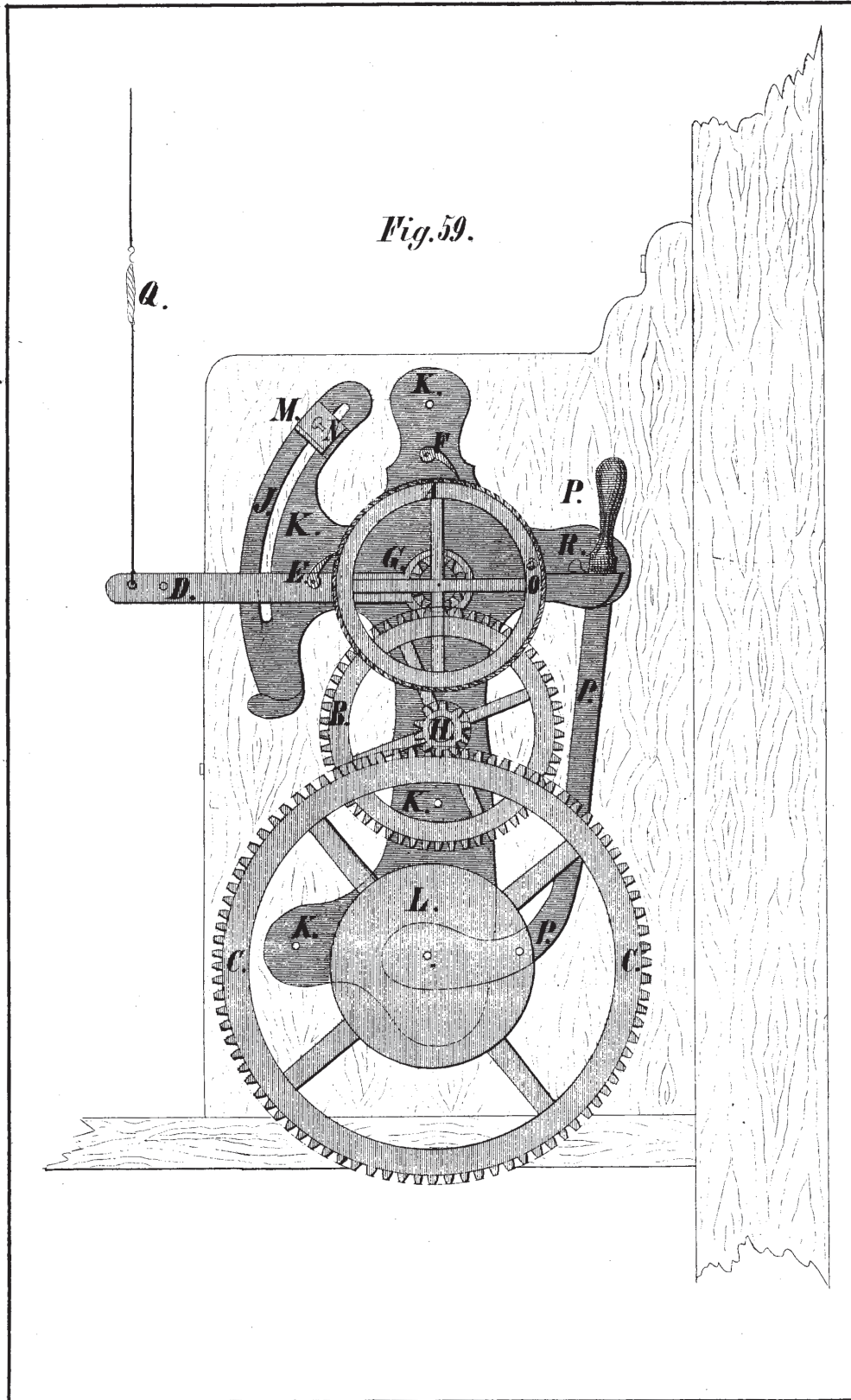

# Taf. 14.

*Fig. 60.*

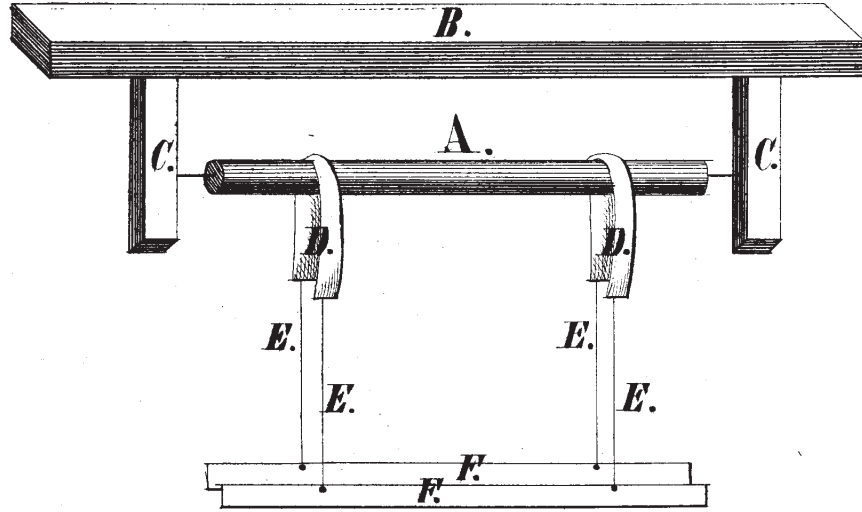

*Fig. 61.*

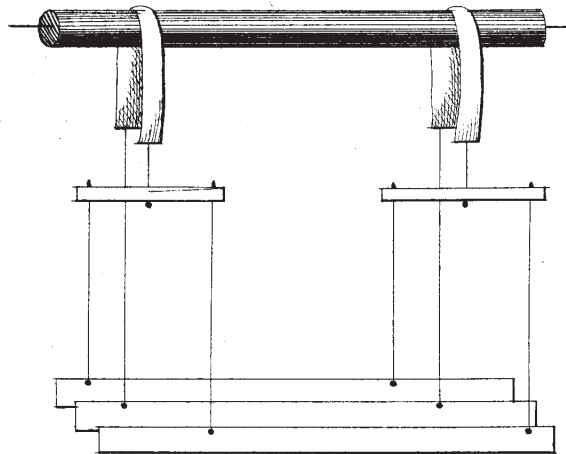

*Fig. 62.*

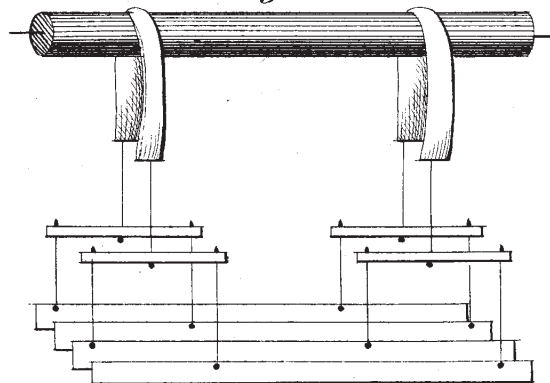

Taf. 15.

Fig. 63.

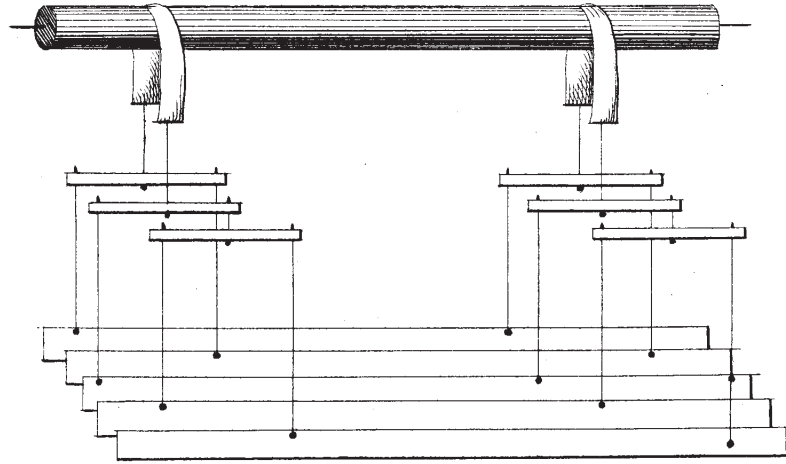

Fig. 64.

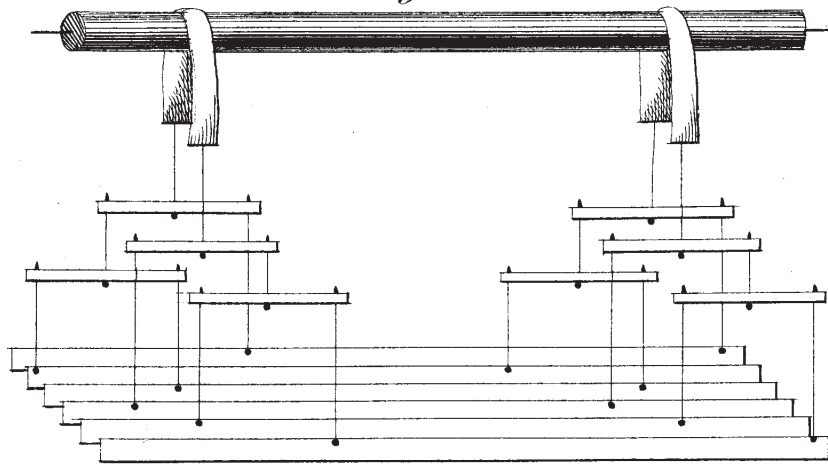
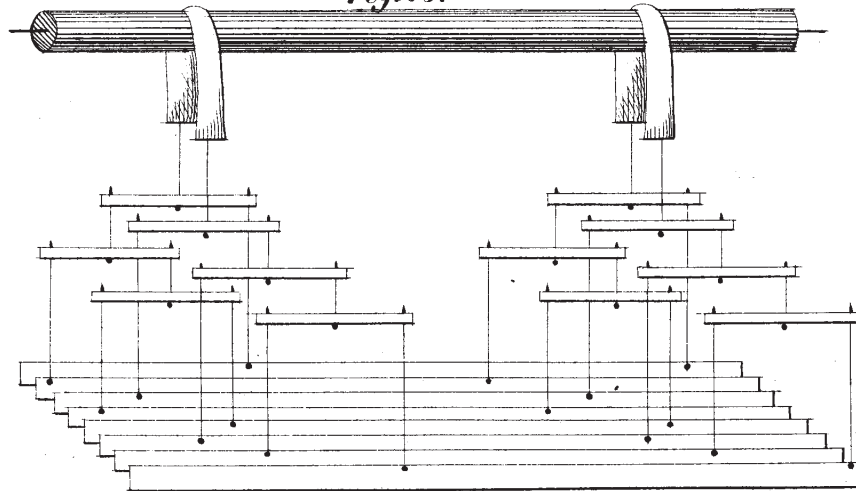
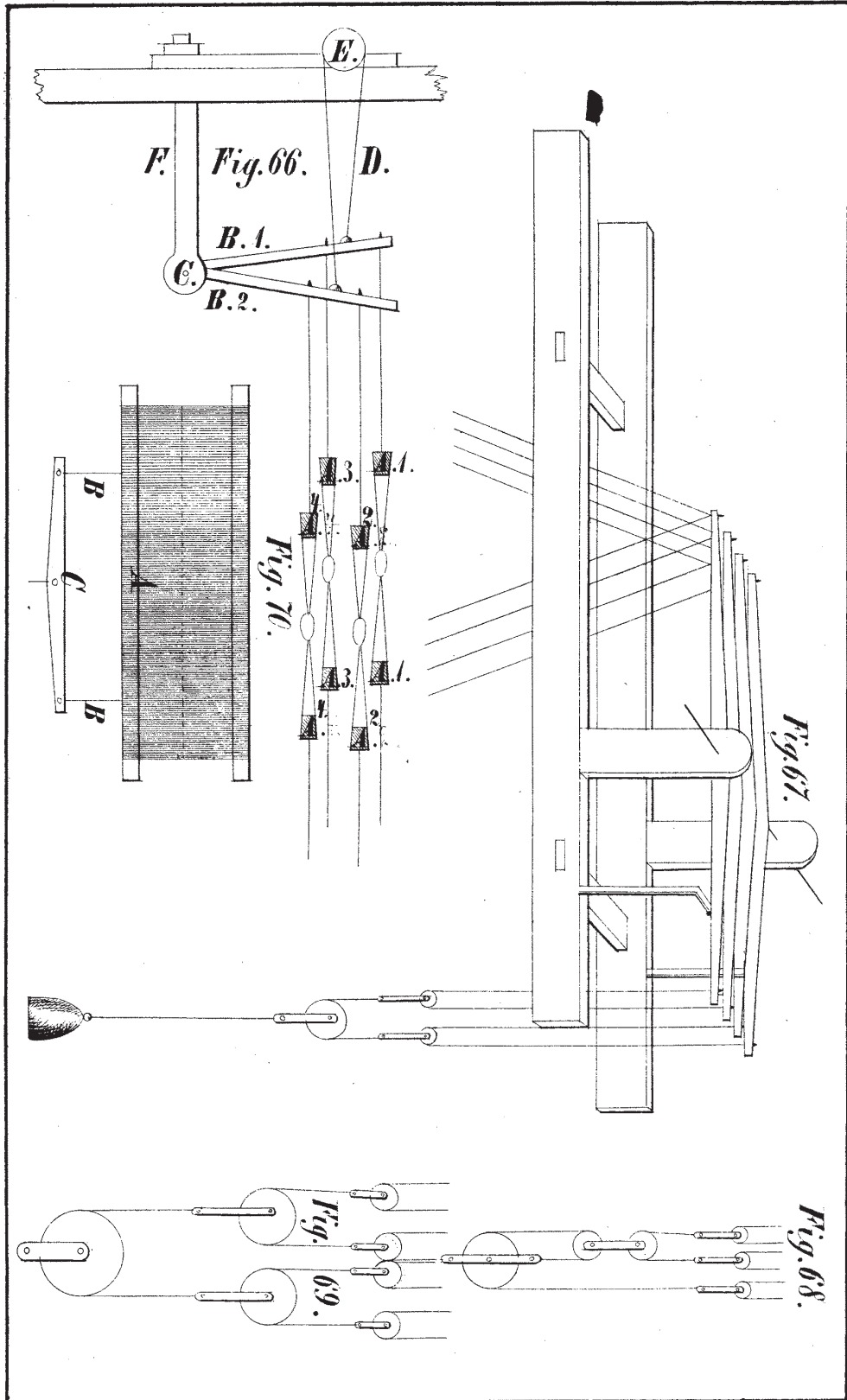

Fig. 65.





Taf.16.



Taf.17.

*D.* Der reine Contremarsch. *A.*

*Fig. 11.*

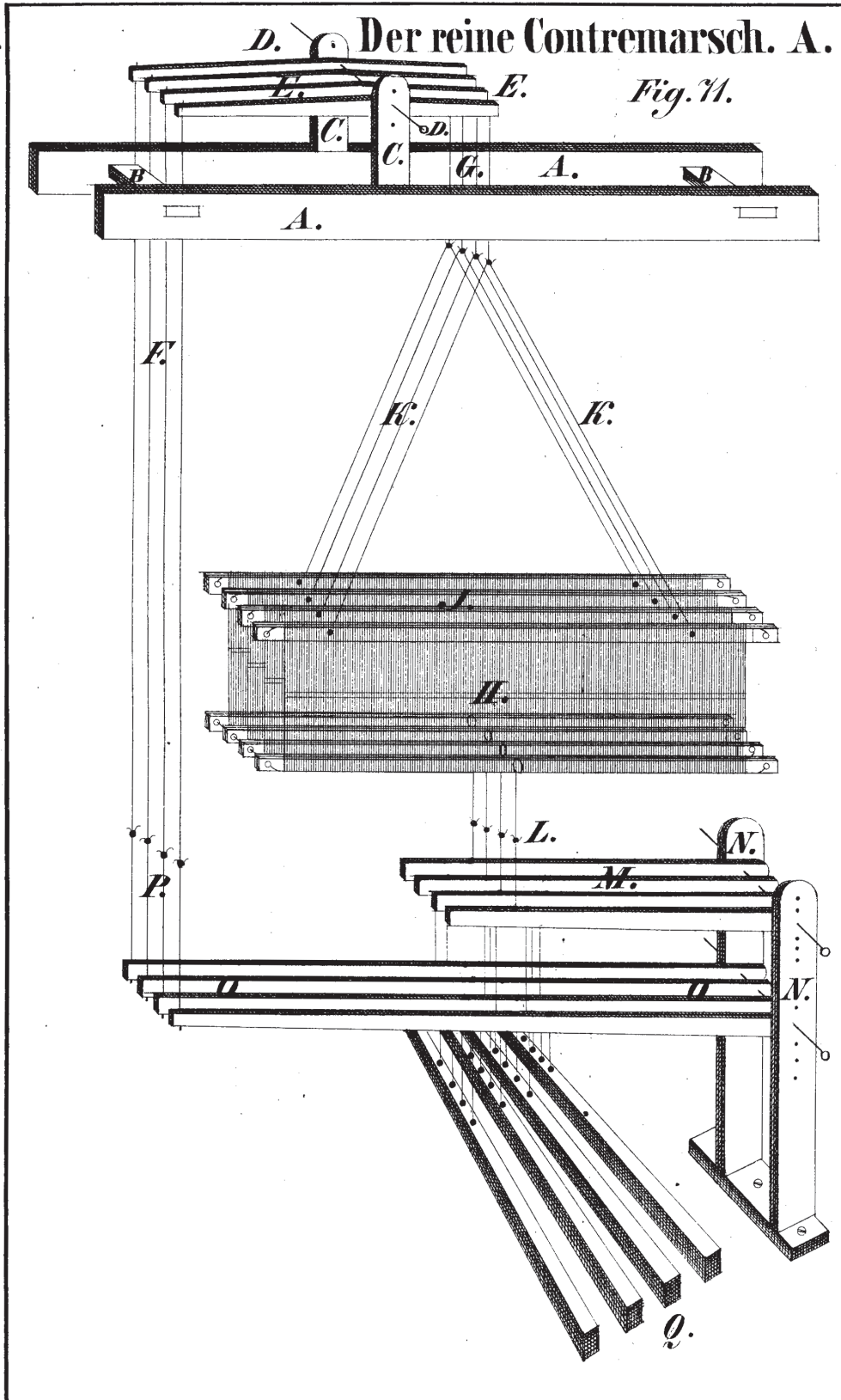

Taf. 18.

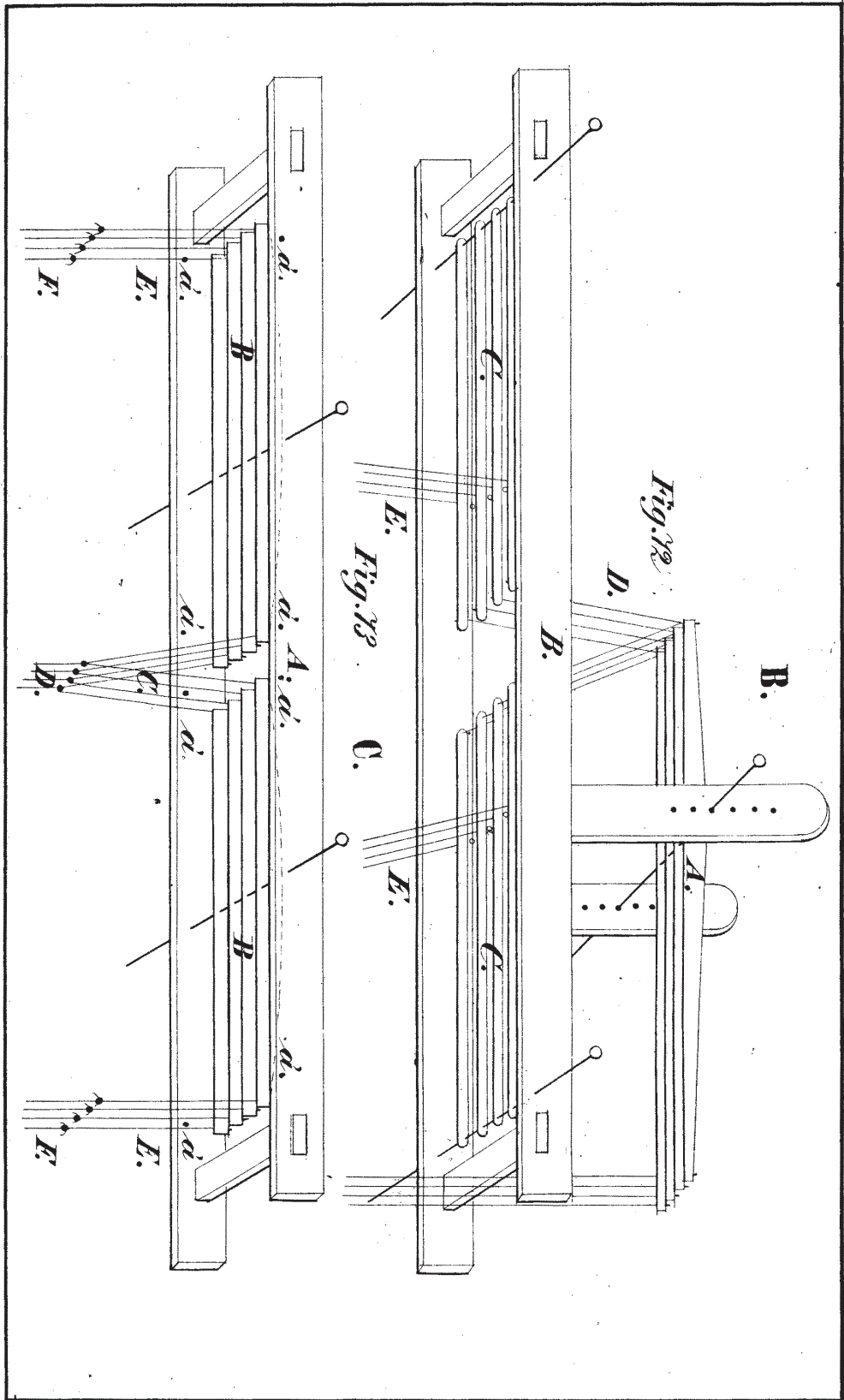

Taf. 19.

Der stehende  
Contremarsch.

Fig. 74.

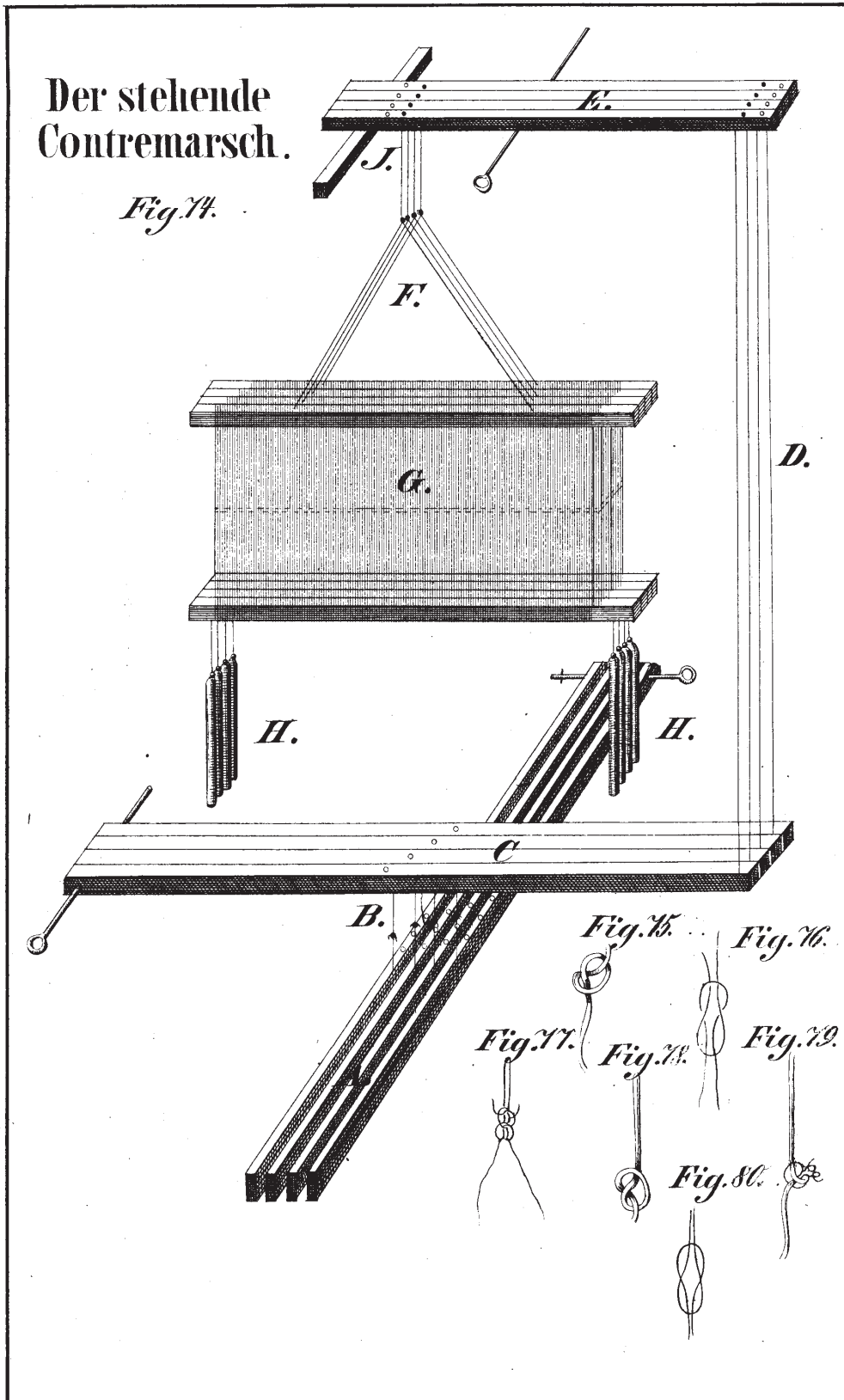

Der hohle  
Contremarsch.

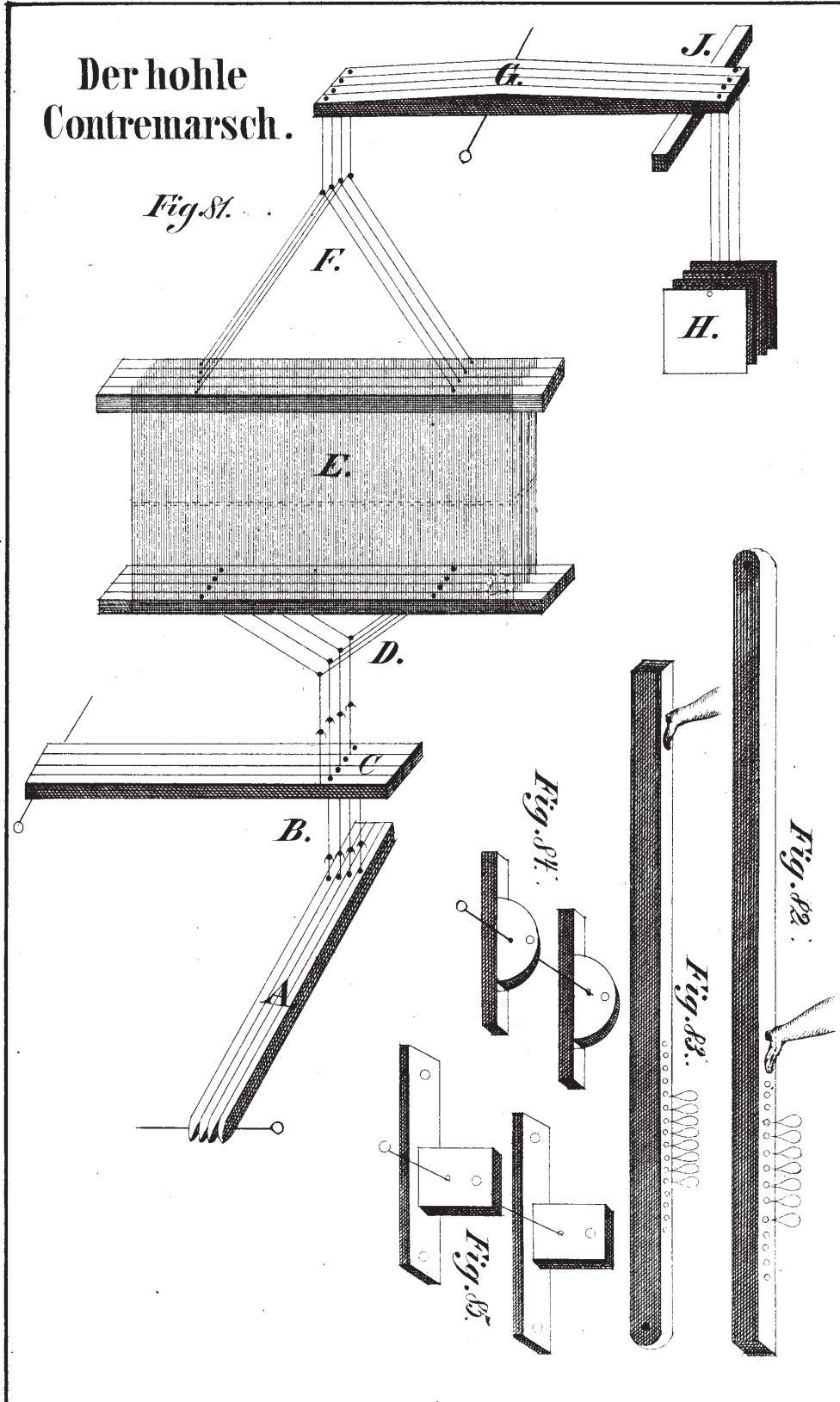

Der rabattirende  
Contremarsch.

Fig.86.

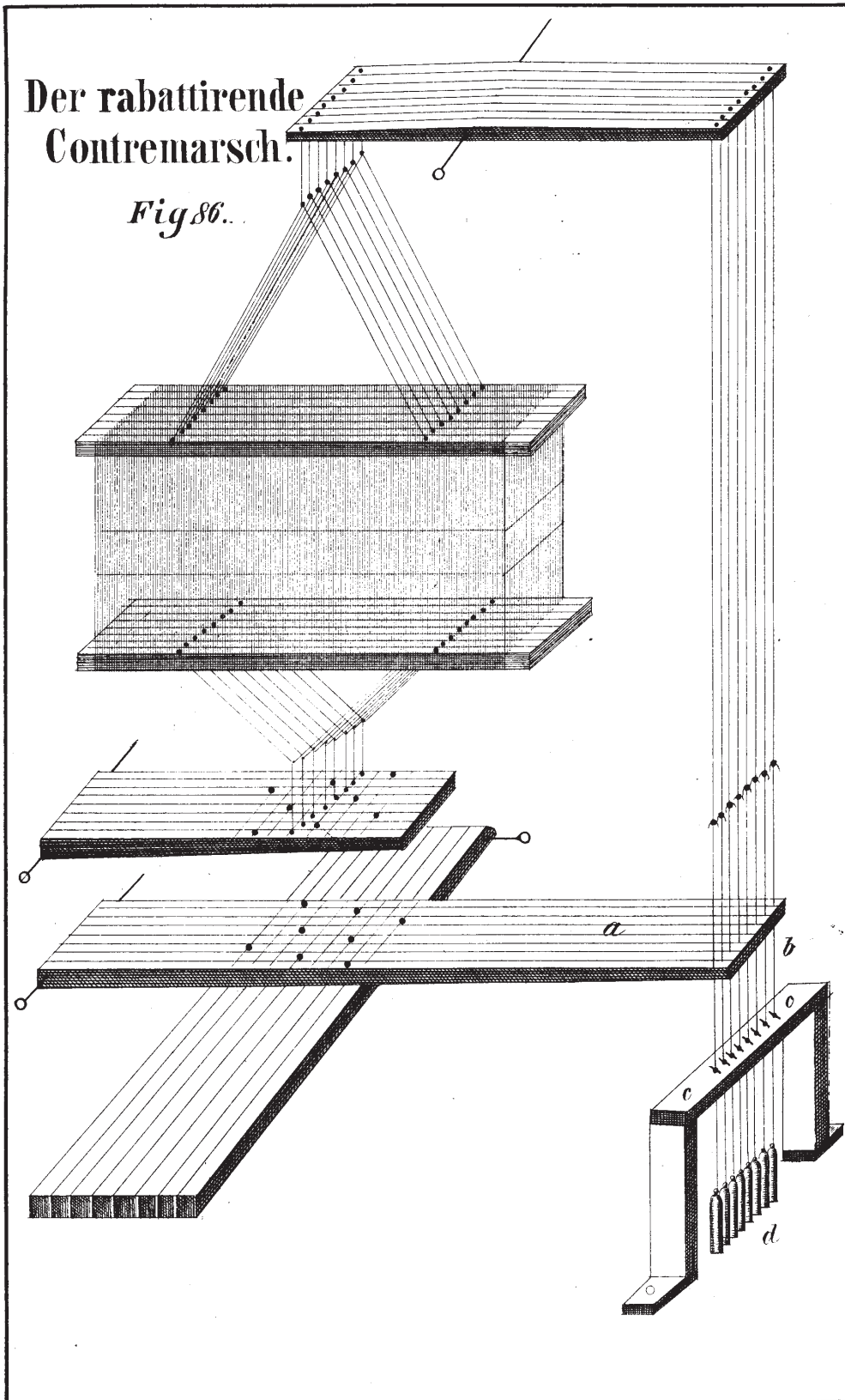

# Taf. 22.

## I. Glatte oder fortlaufende Einzüge.

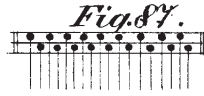

## 2. Versetzte oder zerstreute Einzüge.

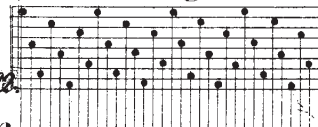

## 3. Spitz einzüge.

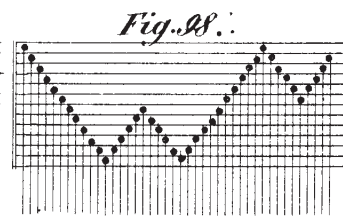
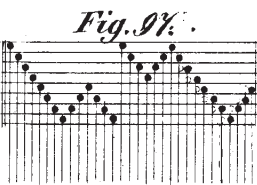
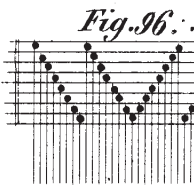
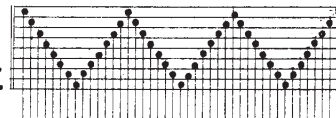

## 4. Zerstreute und fortlaufende Einzüge zugleich.

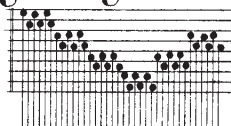
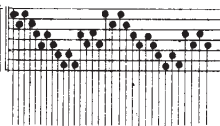
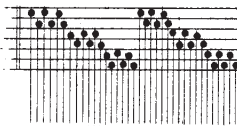
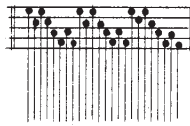

*Fig. 99.*

*Fig. 100.*

*Fig. 101.*

*Fig. 102.*

## Rabattirende Einzüge.

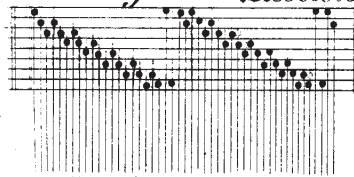

*Fig. 103.*

*Fig. 104.*

## 5. Doppelte Einzüge.

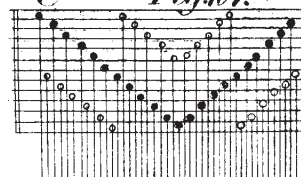
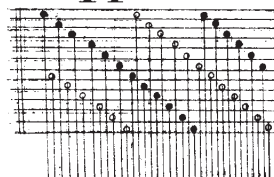
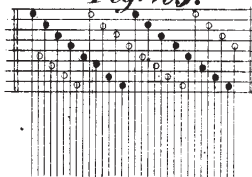
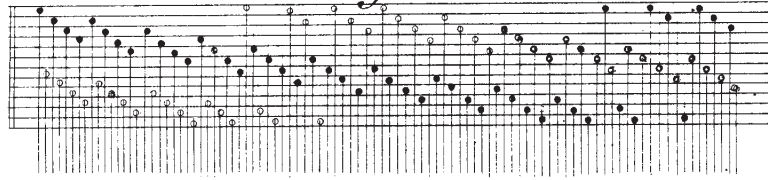

*Fig. 106.*

*Fig. 107.*

# Taf. 23.

## Rabattirend. Fig. 108.



### 6. Gebrochene Einzüge.

Fig. 109.

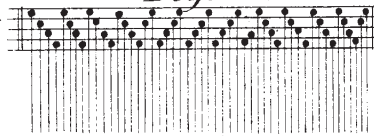

Fig. 110.

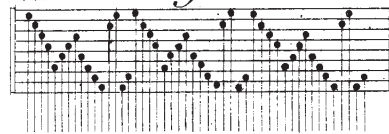

Fig. 111.

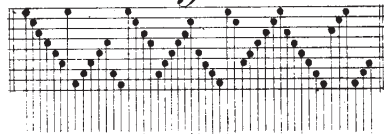
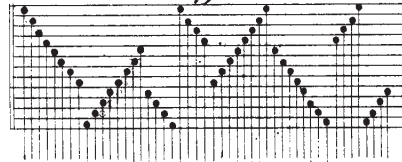

Fig. 112.



### 7. Theilige Einzüge.

Fig. 113.

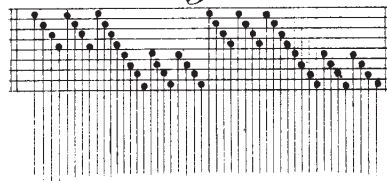

Fig. 114.

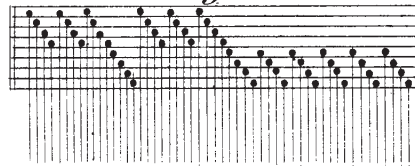

Fig. 115.

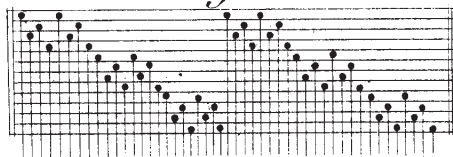

Fig. 116.

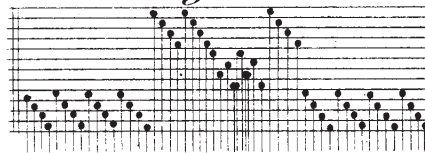
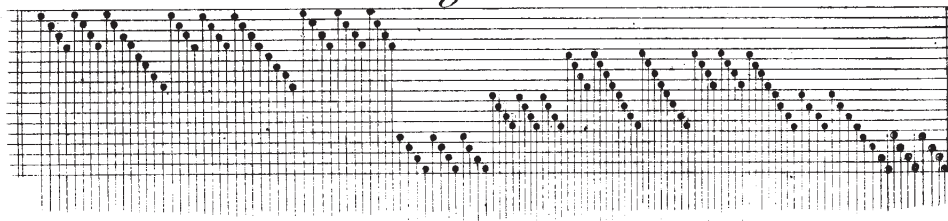

Fig. 117.





# Taf.24.

## Componirte Einzüge

*Fig.118.*



*Fig.119.*

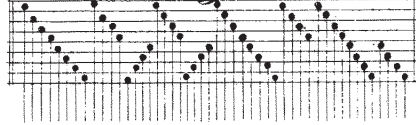

*Fig.120.*

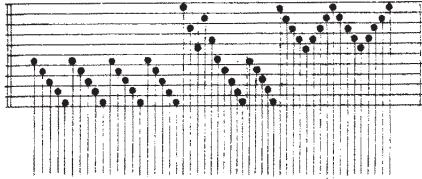

*Fig.121.*

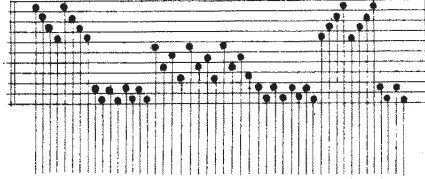

*Fig.122.*

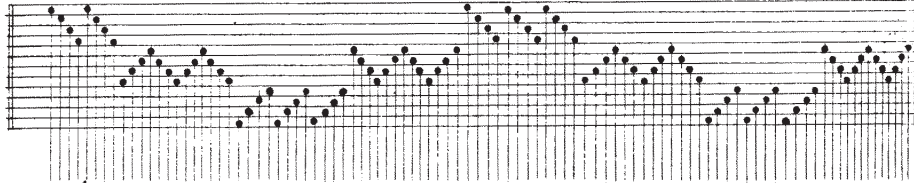

*Fig.123.*

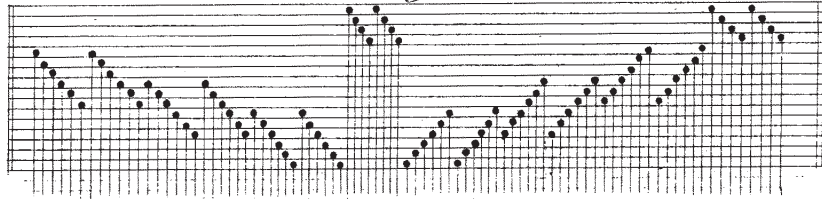

*Fig.124.*

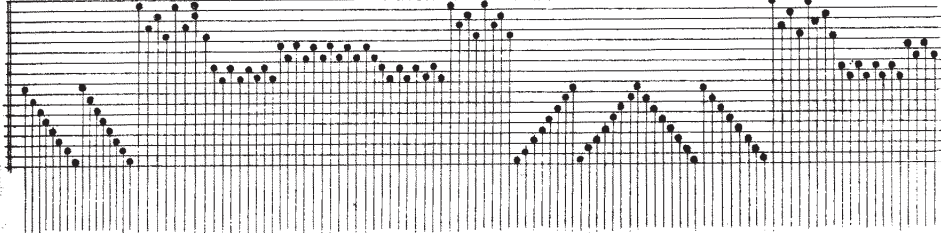

# Der Leinwandbindegrad.

Vorrichtungen.

a. zu 2 Schäften.

1 2 1 2 1 2 1 2

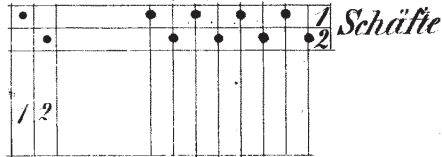

Tritte. Kettfäden.

b. zu 4 Schäften.

1 2 3 4 1 2 3 4 1 2 3 4

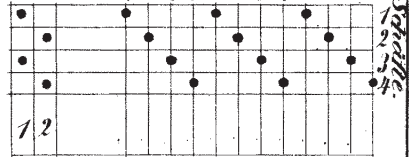

Tritte. Kettfäden.

c. zu 4 Schäften, versetzter Einzug. d. zu 6 Schäften.

1 2 3 4 1 2 3 4 1 2 3 4

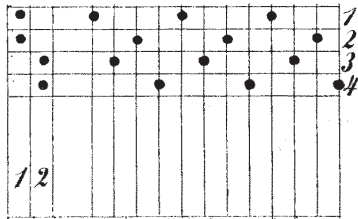

1 2 3 4 5 6 1 2 3 4 5 6

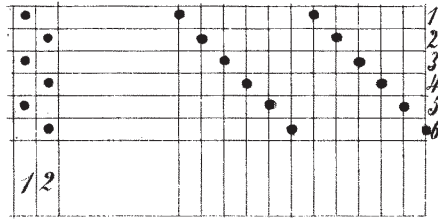

Muster 1.

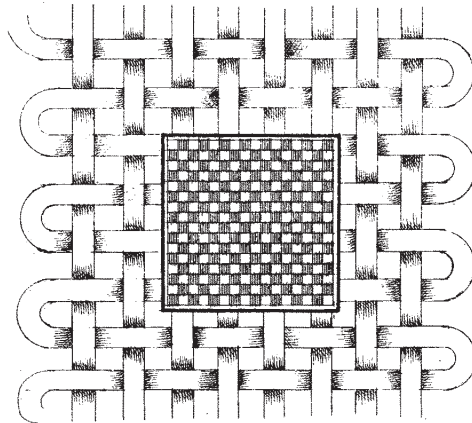

e. zu 6 Schäften, versetzter Einzug.

1 2 3 4 5 6 1 2 3 4 5 6

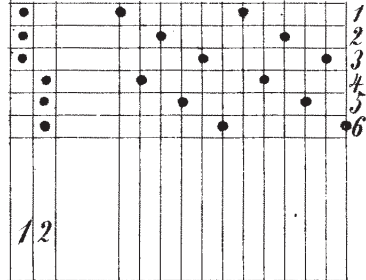

f. zu 8 Schäften.

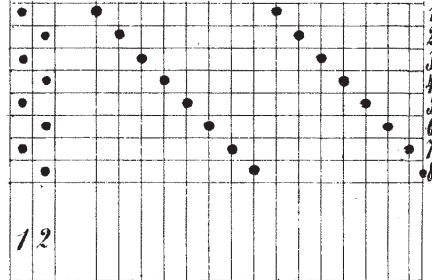

# Der Körperbindegrad.

## A. Einseitige Körper

### I. Unterabtheilung.

3 bindig, Schuss oben. 3 bindig, Kette oben. 4 bindig, Schuss oben.

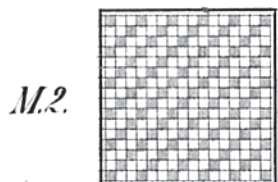

Reihung.

Tritte

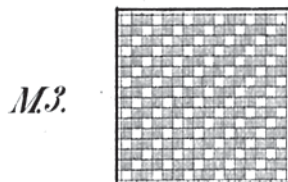

Reihung.

Tretweise

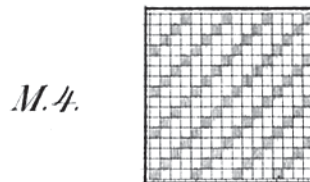

Reihung.

Tritte

4 bindig, Kette oben. 5 bindig, Schuss oben. 5 bindig, Kette oben.

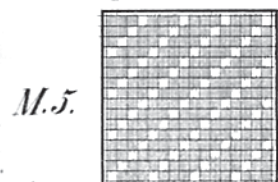

Versetzte Reihung.

Tritte

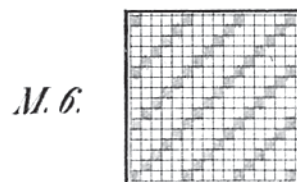

Reihung.

Tritte

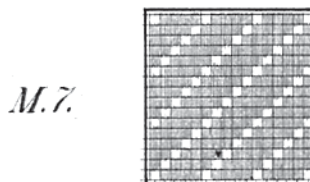

Reihung.

Tretweise.

6 bindig, Schuss oben. 6 bindig, Kette oben. 7 bindig, Schuss oben.

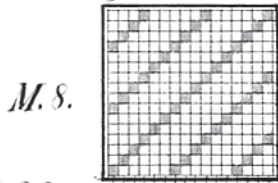

Reihung.

M. 8.

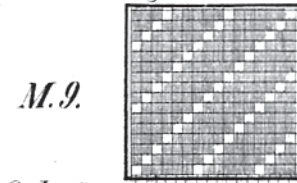

Reihung.

M. 9.

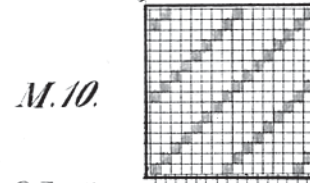





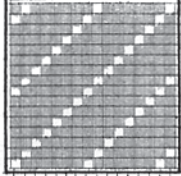
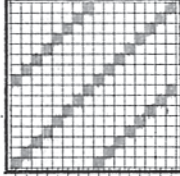
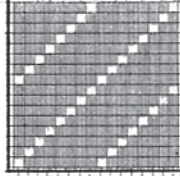

Reihung.

M. 10.

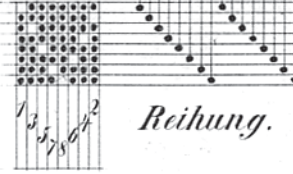
Tafel 27.

7bindig, Kette oben. 8bindig, Schuss oben 8bindig, Kette oben.

<p>M.11.</p> 	<p>M.12.</p> 	<p>M.13.</p> 
<p>Schnür:</p> 	<p>Schnür:</p> 	<p>Schnür:</p> 
<p>Reihung.</p> 	<p>Reihung.</p> 	<p>Reihung.</p> 

M.14.

M.15.

M.16.

9bindig, Kette oben. 10bindig, Schuss oben. 11bindig, Kette oben.

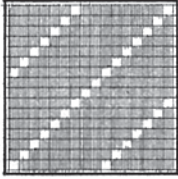
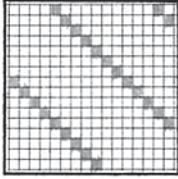
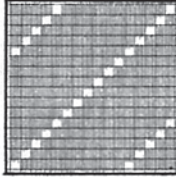
		
--	--	--

M.17.

M.18.

M.19.

12bindig, Schuss oben. 13bindig, Kette oben. 14bindig, Schuss oben.

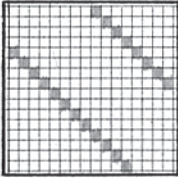
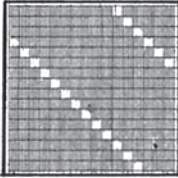
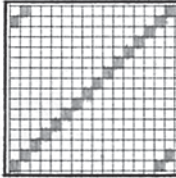
		
---	---	---

M.20.





M.21.

15bindig, Kette oben. 16bindig, Schuss oben.

	
---	--

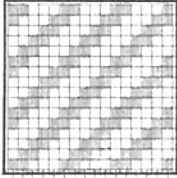
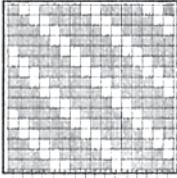
Tafel 28.

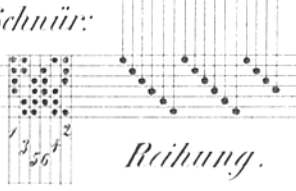
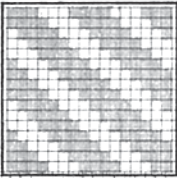
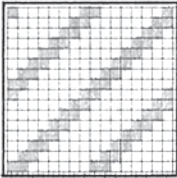
II. Unterabtheilung.

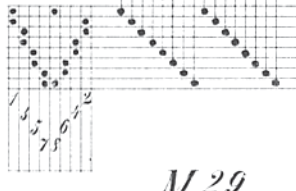
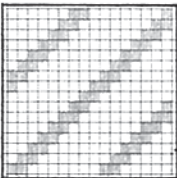
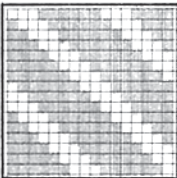
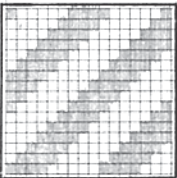
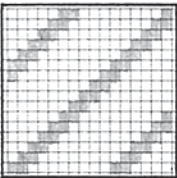
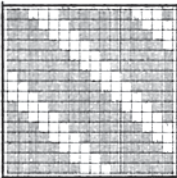
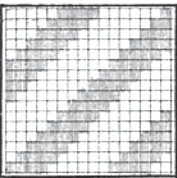
	<i>5bindig.</i>	<i>6 bindig.</i>	<i>7 bindig.</i>
<i>M.22.</i>		<i>M.23.</i>	
<i>Schnür:</i>		<i>Schnür:</i>	
	<i>Reihung.</i>		<i>Reihung.</i>
	<i>7 bindig.</i>	<i>8 bindig.</i>	<i>8 bindig.</i>
<i>M.25.</i>		<i>M.26.</i>	
<i>Schnür:</i>		<i>Schnür:</i>	
	<i>Reihung.</i>		<i>Reihung.</i>
	<i>M.28.</i>	<i>M.29.</i>	<i>M.30.</i>
	<i>9 bindig.</i>	<i>9 bindig.</i>	<i>9 bindig.</i>
			
	<i>M.31.</i>	<i>M.32.</i>	<i>M.33.</i>
	<i>10 bindig.</i>	<i>10 bindig.</i>	<i>10 bindig.</i>
			

Tafel 29.

*M.34.*  
*11 bindig.*

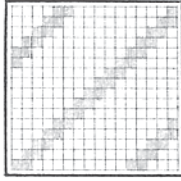

*M.35.*  
*11 bindig.*

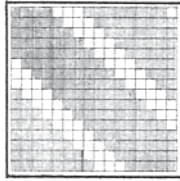

*M.36.*  
*11 bindig.*

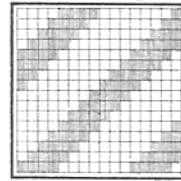

*M.37.*  
*11 bindig.*

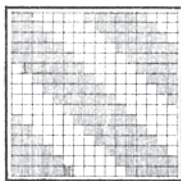

*M.38.*  
*12 bindig.*

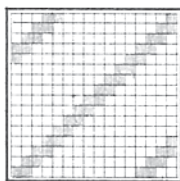

*M.39.*  
*12 bindig.*

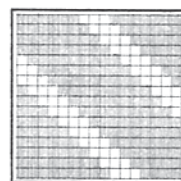

*M.40.*  
*12 bindig.*

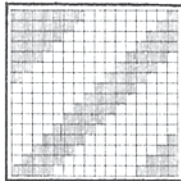

*M.41.*  
*12 bindig.*

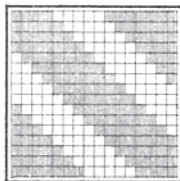

*M.42.*  
*13 bindig.*

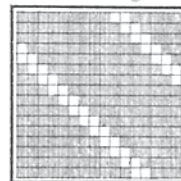

*M.43.*  
*13 bindig.*

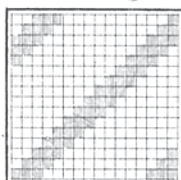

*M.44.*  
*13 bindig.*

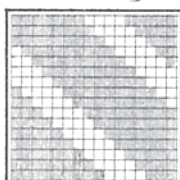

*M.45.*  
*13 bindig.*

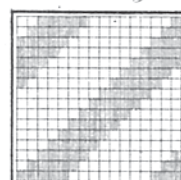

*M.46.*  
*13 bindig.*

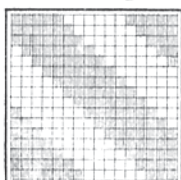

*M.47.*  
*14 bindig.*

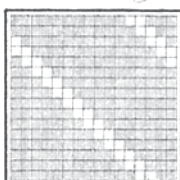



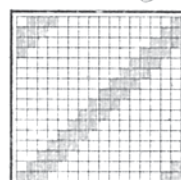





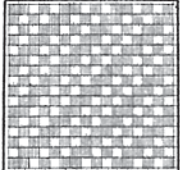
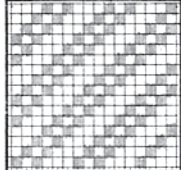
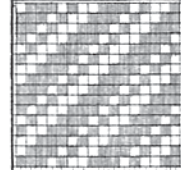

*M.48.*  
*14 bindig.*



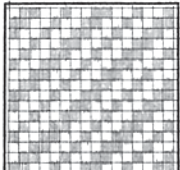
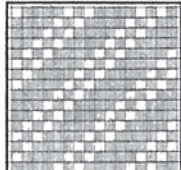
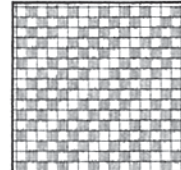
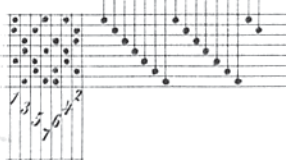

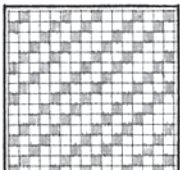
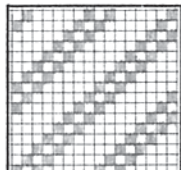
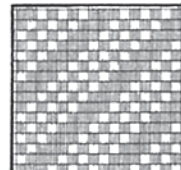
Tafel 31.

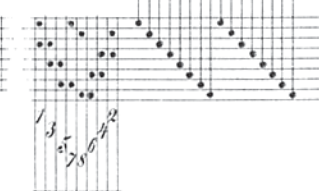
III. Unterabtheilung.

<p><i>5 bindig</i></p> <p>M.64.</p> 	<p><i>6 bindig.</i></p> <p>M.65.</p> 	<p><i>7 bindig.</i></p> <p>M.66.</p> 
		
<p><i>7 bindig.</i></p> <p>M.67</p> 	<p><i>7 bindig.</i></p> <p>M.68.</p> 	<p><i>7 bindig.</i></p> <p>M.69.</p> 
		
<p><i>7 bindig.</i></p> <p>M.70.</p> 	<p><i>8 bindig.</i></p> <p>M.71.</p> 	<p><i>8 bindig.</i></p> <p>M.72.</p> 
		



Tafel 32.

M.73. 8bindig.

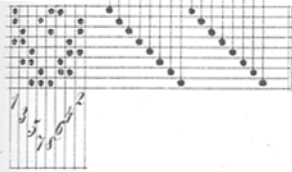
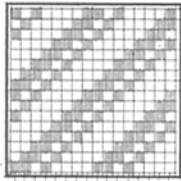

M.74. 8bindig.

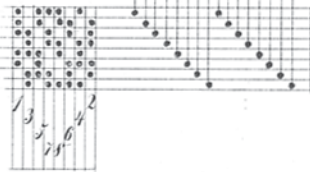
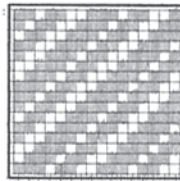

M.75. 8bindig.

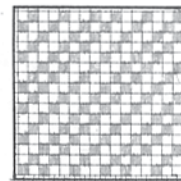

M.76. 8bindig.

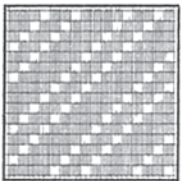

M.77. 9bindig.

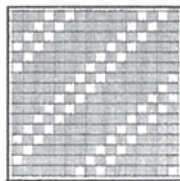

M.77.

M.78. 9bindig.

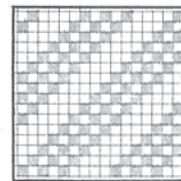

M.78.

M.79. 9bindig.

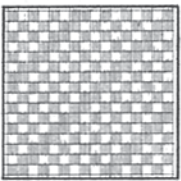

M.80. 9bindig.

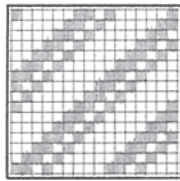

M.81. 9bindig.

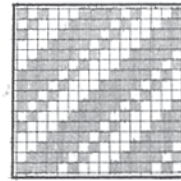

M.82. 9bindig.

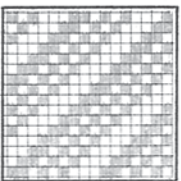

M.83. 9bindig.

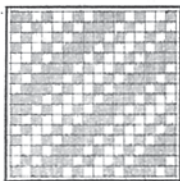

M.84. 9bindig.

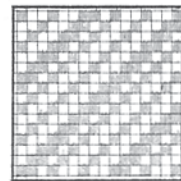

Taf. 33.

M.85.  
9 bindig

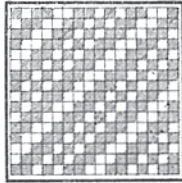

M.86.  
9 bindig.

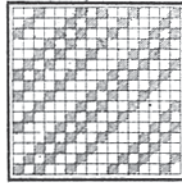

M.87.  
9 bindig

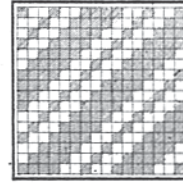

M.88.  
9 bindig

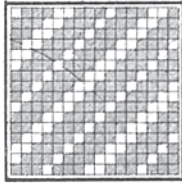

M.89.  
9 bindig.

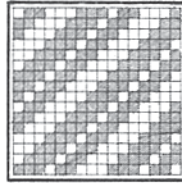

M.90.  
9 bindig

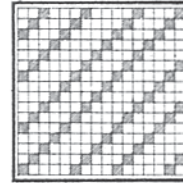

M.91.  
9 bindig.

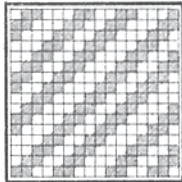

M.92.  
10 bindig.

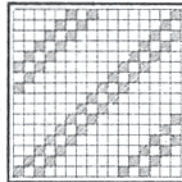

M.93.  
10 bindig.

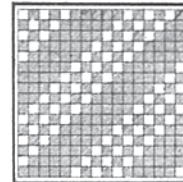

M.94.  
10 bindig.

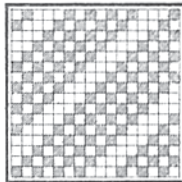

M.95.  
10 bindig

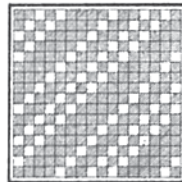

M.96.  
10 bindig.

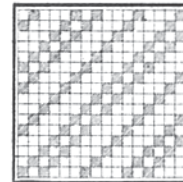

M.97.  
10 bindig

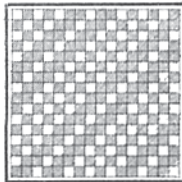

M.98.  
10 bindig

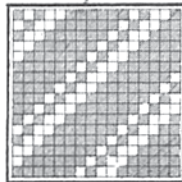

M.99.  
10 bindig

