

Posselt's Textile Library, Vol. IV.

---

NEW AND REVISED EDITION

OF

# THE JACQUARD MACHINE

ANALYZED AND EXPLAINED,

The Preparation of Jacquard Cards

AND

Practical Hints to Learners of Jacquard Designing

BY

E. A. POSSELT,

Consulting Expert on Textile Designing and Manufacturing.

Author and Publisher of "Technology of Textile Design," "Structure of Fibres, Yarns and Fabrics," "Textile Calculations," "Textile Machinery Relating to Weaving," "Posselt's Textile Library," Editor of "The Textile Record," Editor of Textile Terms in "Standard Dictionary" and "Iconographic Encyclopædia of the Arts and Sciences," Principal of "Posselt's Private School of Textile Design," formerly Headmaster of the Textile Department of the Pennsylvania Museum and School of Industrial Art, Philadelphia.

WITH 230 ILLUSTRATIONS.

PRICE, THREE DOLLARS.

---

PHILADELPHIA:

E. A. POSSELT, Author and Publisher,  
2028 Berks Street, and  
2152 N. Twenty-first Street.

LONDON:

SAMPSON LOW, MARSTON & COMPANY, LIMITED,  
St. Dunstan's House,  
Fetter Lane, Fleet Street, E. C.

---

(Copyrighted by E. A. POSSELT.)

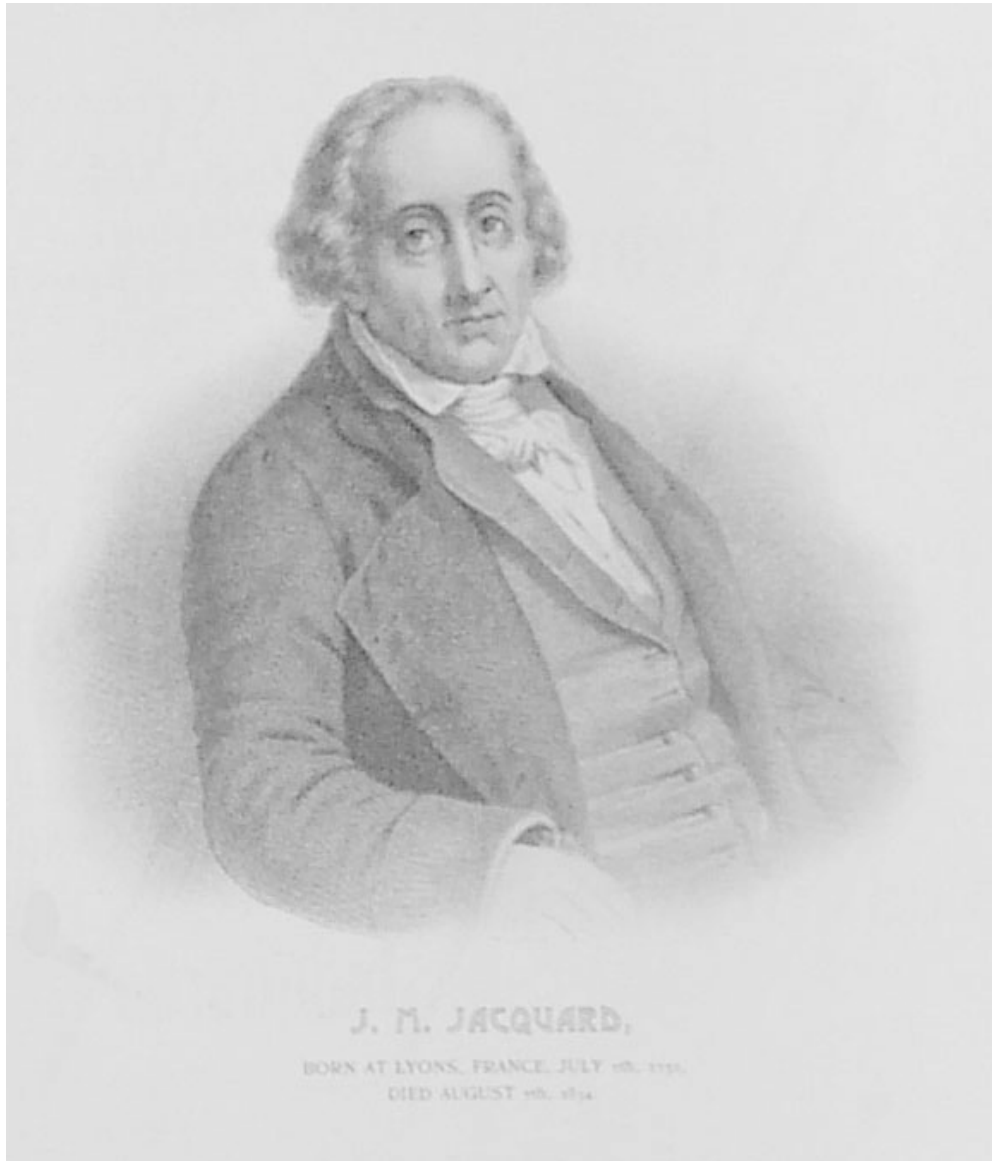

**J. M. JACQUARD,**

BORN AT LYONS, FRANCE, JULY 10. 1732.  
DIED AUGUST 10. 1814.

# PREFACE.

---



THE quick sale of the first three editions of the book shows the value and need of it to manufacturers, designers, overseers and students in textile manufacturing.

In the present New and Revised Edition such changes in the description and illustration of Jacquard Machinery have been made as necessary to have the work up-to-date.

The purpose of the book is to impart to its readers a clear understanding of the principles underlying the construction of the Jacquard Machine, Tying-up of Jacquard Harness, Card-stamping, Card-lacing, and Designing for Jacquard Fabrics.

If in search of information as to the latest improvements in the various machinery needed in the manufacture of Jacquard Fabrics, the reader is referred to "Improvements in Textile Machinery Relating to Weaving," of which work he will find Abstract of Contents in the rear part of this book.



STATUE OF JACQUARD IN PUBLIC SQUARE OF LYONS, FRANCE, HIS NATIVE CITY.

REPRINTED FROM THE ORIGINAL PHOTOGRAPH, THE PROPERTY OF M. A. FURBUSH, ENQ., PHILA.

## TABLE OF CONTENTS.

---

|   | PAGE. |
|---|-------|
| <b>History of the Jacquard Machine,</b> . . . . .   | 7     |
| <b>The Jacquard Machine—General Arrangement and Application,</b> . . . . .                              | 9     |
| <b>Illustration of the different parts of the Jacquard Machine—Method of Operation, etc.,</b> . . . . . | 11    |
| <b>The Jacquard Harness—The Comber-boards,</b> . . . . .  | 20    |
| <b>Tying-up of Jacquard Harness,</b> . . . . .  | 23    |
| I.—Straight-through Tie-up, . . . . .   | 23    |
| II.—Straight-through Tie-up for Repeated Effects, in one Repeat of the Design, . . . . .                | 29    |
| III.—Straight-through Tie-up of Jacquard Loom, having Front Harness attached, . . . . .                 | 31    |
| IV.—Centre Tie-up, . . . . .  | 33    |
| V.—Straight-through and Point Tie-ups Combined, . . . . .   | 35    |
| VI.—Straight-through Tie-up in Two Sections, . . . . .  | 48    |
| VII.—Tying-up a Jacquard Harness for Figuring Part of the Design with an Extra Warp, . . . . .          | 51    |
| VIII.—Straight-through Tie-up in Three Sections, . . . . .  | 53    |
| IX.—Point Tie-up in Three Sections, . . . . .   | 55    |
| X.—Combination Tie-up in Two Sections, . . . . .  | 56    |
| XI.—Straight-through Tie-up in Four Sections, . . . . .   | 57    |
| XII.—Tying-up of Jacquard Looms with Compound Harness attached, . . . . .                               | 58    |
| XIII.—Tying-up Jacquard Looms for Gauze Fabrics, . . . . .  | 64    |
| <b>Modifications of the Single Lift Jacquard Machine,</b> . . . . .                                     | 67    |
| I.—Double Lift Single Cylinder Jacquard Machine, . . . . .  | 67    |
| II.—Double Lift Double Cylinder Jacquard Machine, . . . . .   | 69    |
| III.—Substitution of Tail-cords for Hooks, . . . . .  | 71    |
| <b>Tying-up of Jacquard Harness for Two-ply Ingrain Carpet,</b> . . . . .                               | 72    |
| General Description of the Construction of the Fabric, . . . . .  | 72    |
| Straight-through Tie-up for Ingrain Carpet, . . . . .   | 74    |
| Point Tie-up for Ingrain Carpet, . . . . .  | 78    |

### APPENDIX.

|   |    |
|---|----|
| <b>Preparing and Stamping of Jacquard Cards,</b> . . . . .          | 85 |
| Dobby Card Punching Machines, . . . . .                             | 86 |
| Piano Card Stamping Machines, . . . . .                             | 86 |
| Stamping of Cards, . . . . .  | 91 |
| Repeating Jacquard Cards by the Positive Action Repeater, . . . . . | 92 |
| <b>Lacing of Jacquard Cards,</b> . . . . .                          | 97 |
| Lacing of Jacquard Cards by Hand, . . . . .                         | 97 |
| Lacing of Jacquard Cards by Machine, . . . . .                      | 98 |

TABLE OF CONTENTS.—CONTINUED.

**PRACTICAL HINTS TO LEARNERS OF JACQUARD DESIGNING.**

|  | PAGE. |
|--|-------|
| <b>Squared Designing Paper for the different Textile Fabrics executed on the Jacquard Machine,</b>   | 103   |
| Practical Use of the Heavy Square in Designing Paper,  | 105   |
| Selection of Designing Paper for Single Cloth,   | 105   |
| Selection of Designing Paper for Double Cloth,   | 106   |
| Selection of Designing Paper for Two-ply Ingrain Carpet,   | 106   |
| Selection of the Proper Brush for the different □ Designing Papers,                                  | 107   |
| Colors used for Painting Textile Designs,  | 107   |
| Preservation of Textile Designs,   | 107   |
| <b>Sketching of Designs for Textile Fabrics to be executed on the Jacquard Machine,</b>              | 108   |
| Methods of Setting the Figures,  | 108   |
| Size of Sketch Required,   | 109   |
| Enlarging and Reducing Figures for Sketches,   | 110   |
| Transferring of the Sketch to the Squared Designing Paper,   | 112   |
| Outlining in Squares,  | 113   |
| Rules for Outlining in Squares Inside or Outside the Drawing Outline,                                | 114   |
| Illustration of a Sketch—Outlining on □ Paper—Finished Design—Fabric Sample (Single Cloth),          | 115   |
| <b>Designs for Damask Fabrics to be executed on a Jacquard Loom, with Compound Harness attached,</b> | 116   |
| Designs for Two-ply Ingrain Carpet,  | 116   |
| Designs for Dressgoods Figured with Extra Warp,  | 117   |
| Designs for Figured Pile Fabrics,  | 118   |
| The Shading of Textile Fabrics by the Weave,   | 118   |

## The Jacquard Machine.—General Arrangement and Application.

---

If a fabric contains a great number of ends of warp bound differently in the filling, the method of guiding the warp by harness frames is too cumbrous and inefficient; in such cases it becomes necessary to use the Jacquard machine for raising the warp-threads separately by means of hook and leash.

The Hooks as used for raising leash, mail, lingo, and warp-thread, consist of wires 16 to 17 inches long, with a crook on each end. On the lower crook is fastened the leash by means of the neck-cord.

The cords of each leash are threaded through the holes of the comber-board; the latter are separated from each other according to the texture of the warp in reed.

On the harness-cords are adjusted the heddles, (either twine or wire), on which are fastened the lingoes as weights. In the mails of the heddles are drawn the warp-threads.

Now, from the foregoing explanations, it will be apparent that by raising the hook in the Jacquard machine we raise the leash, and the latter raises every warp-thread throughout the fabric for interlacing with the filling.

The next point required to be known is, which hooks are to be raised, and which are to be lowered? To regulate this, a design (pattern) is prepared in which the floating of the warp over the filling is indicated.

For the warp-threads required to be raised holes are punched in the cards. In these holes the points of the needles extending through the needle-board are pushed by a spring fastened on the rear of each needle. The needles are adjusted in rows of different heights. The arrangements most used are 4, 8, and 12 rows high. Each row as to height in the machine contains a bar (knife) in the griffe. When the griffe is down, or the machine at rest, the upper crooks of the hooks are raised about half an inch above the griffe-bars.

The needles which control the position of the hooks, permitting them to rise or compelling them to remain stationary, are pressed by the springs fastened in the rear towards the cards, which are moved on a quadrilateral and perforated cylinder. This cylinder performs a movement similar to a pendulum towards the points of the needles. Any needle for which a hole was punched in the card will penetrate the cylinder; consequently, the corresponding hook will remain in its natural position, ... the crook over the corresponding griffe-bar, and upon lifting the griffe the hook will be raised.

Again, needles for which no holes are punched in the cards will be thrust back by moving the cylinder containing the cards towards the needle-board; this motion

forces back the corresponding hooks, pushing them away from the griffe-bars above, and upon raising the griffe they will remain stationary; hence, if a blank card were pressed against all the needles of any machine, the entire number of needles the machine contains would be pushed back, and none of the hooks would come in contact with the griffe-bars, and, consequently, raising the griffe would produce an empty lift. On the other hand, using a card having every hole of the cylinder punched, (or the empty cylinder used), would lift every needle in the machine. Pressing the needles towards the rear compresses the springs; these will again expand as soon as the cylinder leaves the needle-board. The hooks, which were left standing in their position over the griffe-bars are caught by the latter at the raising of the griffe. The elevation of these hooks raises the leashes fastened to them, thus causing the lifted warp-threads to form a shed with those not lifted.

Jacquard machines are made of different sizes and descriptions, some having only a few hooks and others a large number. The sizes most often used are 100, 200, 400, 600, 900, 1200 hooks. The number or size is always indicated by the number of needles and hooks which it contains, without counting the reserve rows, of which there are generally two. These reserve rows are used for various purposes, such as raising the selvedge; raising the front harness; raising the shuttle-boxes on hand-loom; guiding the take-up motion on hand-loom; indicating a certain card through ringing a bell on hand-loom, etc.

Sometimes a few of the needles and hooks from the reserve are added to the main part of the needles and hooks. For example: Take a design in which the ground weave repeats on 12 ends; working a 400 machine, we find:

$$400 \div 12 = 33 \text{ repeats of the weave, less 4 hooks;}$$

Consequently, if this ground-weave is repeated all over the width of the fabric, we must use either:

396 hooks, leaving 4 hooks more to be added to the two rows already used; or 408 hooks, requiring us to call upon the reserve rows for eight extra hooks.

Hooks which have no leashes adjusted must be taken out of the machine.

Sometimes two, three, or more, machines are employed on one loom, and may be worked in different manners.



## Illustrations of the Different Parts of the Jacquard Machine.—Method of Operation, etc.

Every Jacquard machine may be divided into the following parts:

1. The Frame and the Perforated Board through which the neck-cords are passed.
2. The Griffe and necessary attachments for lifting the same.
3. The Hooks.
4. The Needles.
5. The Springs and Spring Frame.
6. The Needle-board.
7. The Cylinder, Hammer, and Batten.
8. The Catches.
9. The Cards.
10. The Jacquard Harness.

### THE FRAME.

Fig. I.\* represents the side view of the "frame" of a common 100 Jacquard machine by *a, b, c, d*. The width of the frame in its main part [see 6 to 7] is  $9\frac{1}{2}$  inches.

$1\frac{1}{8}$  inches is the width of the iron casting at the places marked 8 and 9.

2 inches is the height of casting at the place indicated by 1.

$1\frac{1}{2}$  inches is the height of casting at the place indicated by 3.

$1\frac{3}{4}$  inches is the height of casting at the place indicated by 5.

The open part of the frame, marked 2 in drawing, is 6 inches high.

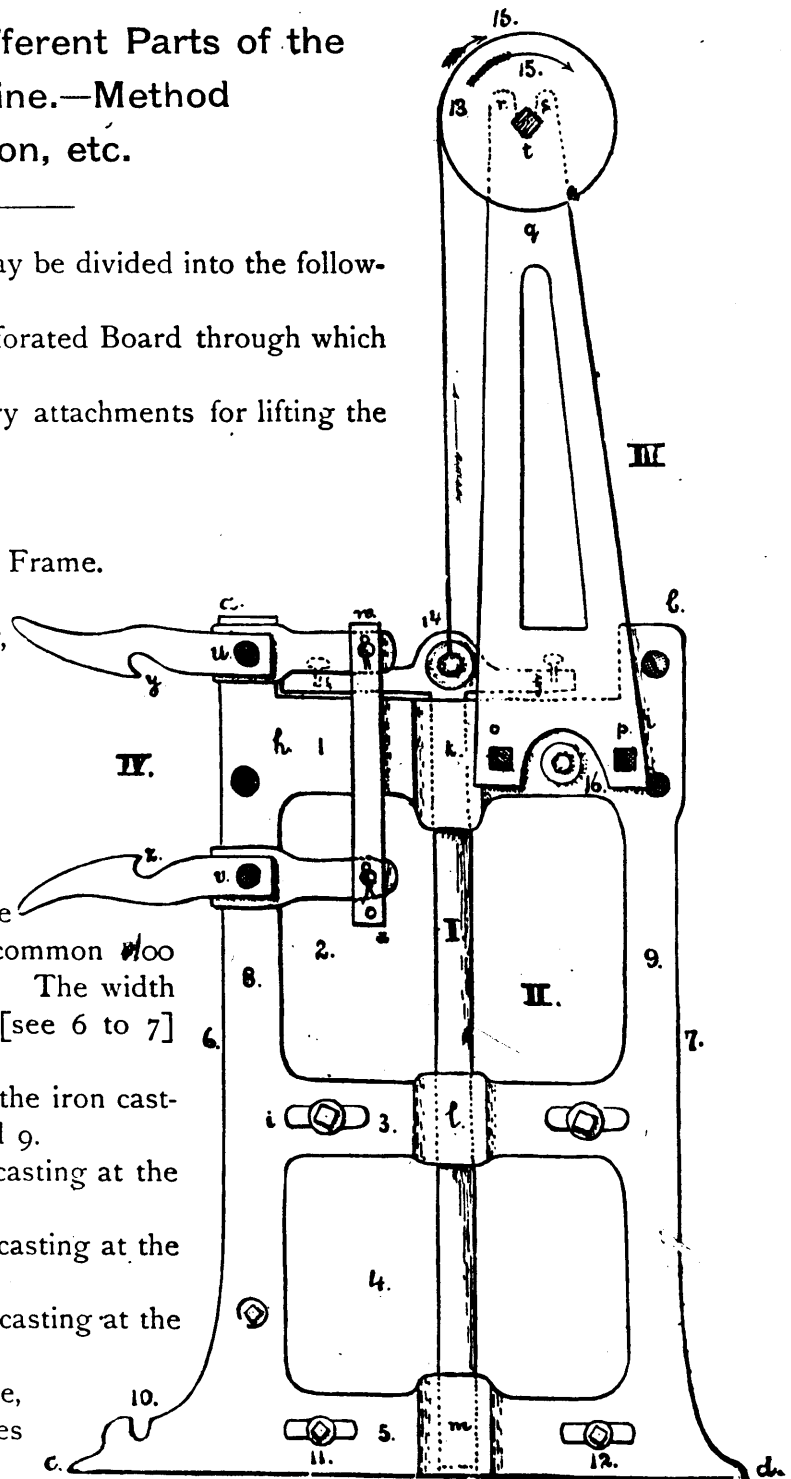

FIG. I.

\* For illustration of the present article a 200 Jacquard machine is used, illustrated on pages 11-17 by Figs. I. to XI., which contains the same principles of construction as any other size machine. These illustrations are drawn one-fourth of the actual size; hence, any measures, etc., we have omitted may readily be found by any student.

The open part of the frame, marked 4 in drawing, is 5 inches high. Hence, the main height of the frame is as follows :

- 1 = 2 inches.
  - 2 = 6 "
  - 3 = 1½ "
  - 4 = 5 "
  - 5 = 1¾ "
- 16¼ inches main height.

**THE PERFORATED BOARD.**

The perforated bottom board, through which the neck-cords are passed, contains one hole for every hook in the machine, and is illustrated in Fig. IX. separately. It shows the following measurements :

- Entire width of board = 8 inches.
- " length " = 12 "
- Thickness " = ¾ "
- Distance of holes from each centre, { *a*, in length of board, 0.27 inch. (See *l* to *b*.)
- " *b*, in width " 7/8 " (See *m* to *w*.)
- " first row from the part of the frame illustrated in Fig. I., 2¾ inches.
- " " " " rear part of the frame, 2½ inches.

This board is fastened by screws to the frame at places indicated in Fig. I. by 11 and 12.

**THE PLUNGER.**

Besides the frame, Fig. I. illustrates: Under I. the Jacquard plunger, ¾ inch diameter, for guiding the griffe (attached to its head) when raising. To strengthen the steadiness of this latter movement shoulders are attached to the frame at the three places where the plunger slides.

- Height of frame at *k*, = 2¾ inches.
- " " *l*, = 2 "
- " " *m*, = 2 "

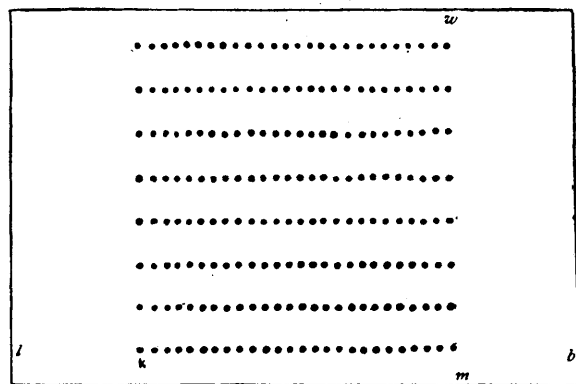

FIG. II.

Screws, *f*, dotted in drawing, on head of plunger, fasten the griffe to it.

Part III. in Fig. I. illustrates the attachment for providing the lifting of the plunger in a hand-loom, likewise the griffe, etc. This consists of a triangular shaped frame 14¼ inches high, or less, according to height of room. This part is fastened to the front part of the frame by bolts at *o* and *p*. In the slot at the top, between *r* and *s*, a wooden cylinder of 3½ inches diameter is fastened to an iron shaft resting in the frame at *t*.

At 13 a leather strap is fastened to this cylinder and to the plunger 14. It will easily be seen that by turning the wooden cylinder in the direction of the arrows, 15, the plunger will be raised with the griffe fastened to its top. By

reversing the action of the cylinder, the plunger and griffe will return to their previous positions. The action thus described constitutes a "single lift," raising and lowering of plunger and griffe for each pick.

**THE CATCHES.**

At IV., Fig. I., the "catches" for turning the cylinder at the lantern are illustrated. The distance of the centre of the screws which hold the catches to the frame is  $4\frac{3}{4}$  inches. Between these two catches the cylinder is adjusted to the batten, and the direction of its turning is regulated by the catch which is brought in contact with the lantern. If the catch, *y*, turns, the cylinder will turn the card situated on its top towards the needle-board, and if catch, *z*, is brought into contact with the lantern, the card hanging below the needle-board will be the next in turn to be pushed towards the needles.



FIG. III.

The entire length of the catches in the present illustration is 8 ins., allowing  $5\frac{1}{4}$  ins. for the catch itself and  $2\frac{3}{4}$  ins. for the part to which it is fastened. Making this catch in two pieces is preferable to the old style of one piece, because the moment of turning the cylinder can be more easily regulated.

**THE GRIFFE.**

Fig. III. illustrates the top view of the griffe. As mentioned before, the griffe is fastened to the plunger by means of screws. In the drawing the dark shaded places marked *f* are the hollow places in the griffe, through which the screws fasten the latter to the plunger. The griffe, like the other parts explained, is made of cast iron, and the machine is of the following dimensions:

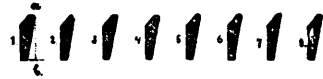

FIG. IV.

- Length of griffe, *a* to *b*, =  $9\frac{3}{4}$  inches.
- Depth " " *a* to *c*, =  $6\frac{5}{8}$  "
- Extension on each side, *e* to *f*, =  $1\frac{1}{2}$  "
- Distance of griffe-bars, *s* to *s*, =  $\frac{7}{8}$  "
- Length " " *m* to *n*, =  $9\frac{1}{4}$  "
- Height " " [see Fig. IV., sectional cut of griffe-bars,] =  $\frac{7}{8}$  inch.

FIG. V.

**THE HOOK.**

Fig. V. represents a hook as used in the present machine, made of No.  $13\frac{1}{4}$  bright spring wire. Height, *a* to *c*, =  $16\frac{5}{8}$  inches. Height of rest, *b* to *c*, =  $6\frac{5}{8}$  inches.

## THE NEEDLE.

Fig. VI. illustrates a needle, as used in connection with the hook. Distance from head to loop,  $9\frac{1}{8}$  inches, =  $a$  to  $c$ . Length of loop,  $1\frac{5}{8}$  inches, =  $c$  to  $d$ .  $10\frac{3}{4}$  inches entire length.



FIG. VI.

The distance from head to eye (for passing through the hook) is regulated according to the row in which the needle belongs. In the present illustration this is, Head to eye, = 7 inches, =  $a$  to  $b$ . The eye, =  $\frac{3}{8}$  inch, =  $b$ .

Eight different positions of the distance of the eye from head will be required by an 8-row machine. The needles are made of No.  $15\frac{1}{2}$  bright spring wire. The loop on the end,  $c$  to  $d$ , permits a pin to be inserted, [see Fig. VII.,  $o$ ], and also holds the needle in position.

Fig. VII. gives a clear understanding of the arrangement of hooks, needles, griffe-bars, springs, frame for holding the latter, and the needle-board. This drawing is in accordance with the preceding ones, executed one-fourth of the actual size, and represents the sectional cut of one cross-row in the Jacquard machine containing 8 hooks, (as it is an 8-row deep machine which we explain):  $e$  to  $e'$ , 1st hook;  $f$  to  $f'$ , 2d hook;  $g$  to  $g'$ , 3d hook;  $h$  to  $h'$ , 4th hook;  $i$  to  $i'$ , 5th hook;  $k$  to  $k'$ , 6th hook;  $l$  to  $l'$ , 7th hook;  $m$  to  $m'$ , 8th hook. These hooks are held in their required places by the eyes of the needles [see place  $v$  at hook 1], through which the former are passed.

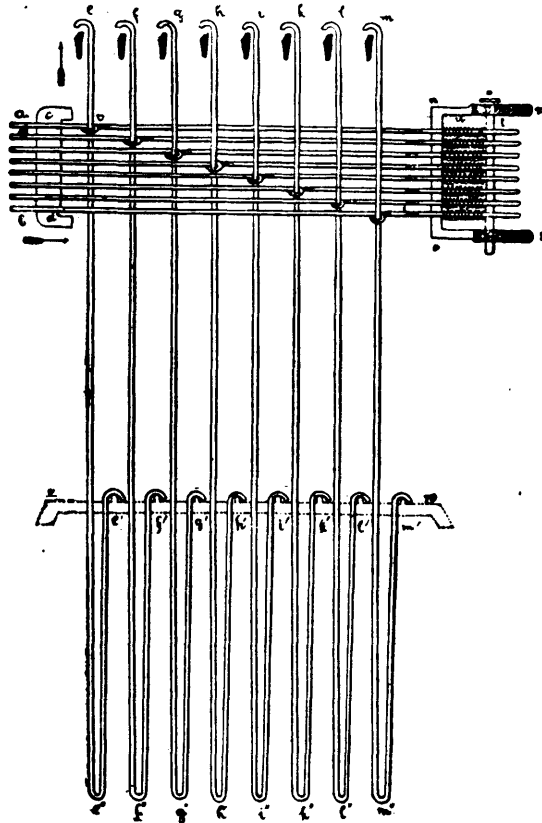

FIG. VII.

$r$ ,  $n$ ,  $p$ ,  $s$ , unshaded, is made of cast iron; the shaded part (extension) is constructed of wood. Below the upper crook of the hooks, the black sections represent a sectional cut of the griffe-bars;  $v$  to  $w$  indicates the rester for the lower hooks, which keeps the latter in their required position.

A study of this illustration will show that when the heads of the needles,  $a$ - $b$ ,

are pushed backwards, in the direction of arrow , the hooks are also moved. If the needles are not pushed, the upper crooks of the hooks will remain in position, as in drawing, over the griffe-bar; and raising the latter will consequently raise every one of these hooks. Therefore, if a blank card is pressed against the 208 needles of the machine, all the needles and hooks will be pushed back, out of the way of contact with the griffe-bars, thus causing an empty lift when they are raised; whereas, by pressing with an empty cylinder, or with a card, containing as many holes as the machine has needles, and so placed that the holes are exactly opposite the needles, none of them would be moved, and each hook would remain vertical over its griffe-bar; and raising the griffe will lift every hook.

As mentioned before, the springs, *u*, are attached to the needles between the needle-frame, *n-p*, and the pin, *o*. Fig. VI., the distance *e* to *f* indicates the part of the loop around which the spring is adjusted, and where it rests against the expansion of the loop. *f*, in Fig. VI., represents the place where pin, *o*, (as shown in Fig. VII.) passes through the loop and is fastened to the needle-frame on top and bottom. Pressing the needle at the head compresses the spring, as the latter is securely fastened on one end by the wider part of the loop, and on the other end by a pin inserted in the loop and fastened to the frame. Remove the pressure at the head of the needle, and the spring will return to its natural position, pushing the needle into its old place. These springs are made of thin brass wire.

It is necessary to keep the needle-eyes in the proper place, otherwise it would result in bending the hook out of its perpendicular position, and by lowering the griffe its bars would possibly come in contact with the head of the hook, crushing the latter, or doing more damage if not detected at once. Each needle or hook, if worn out, can be replaced by pulling out the pin, *o*, thus loosening the needle and giving a chance to work the required hook out of the needle-eye.

#### THE BATTEN MOTION.

Fig. VIII. represents the batten motion to be attached to the guiding-rod, [see No. 14, in Fig. I.], and the frame, [see No. 16, in Fig. I.] The batten, 2, is connected to a triangular lever by means of lever, *d*. Another vertical lever connects the lower part of this triangular lever to a projecting bolt, *k*, fixed to the guiding-rod of the griffe.

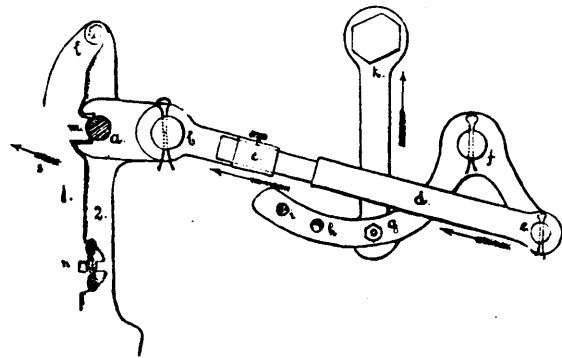

FIG. VIII.

By raising the guiding-rod, thus raising lever, *k*, in the direction of the arrow, the batten is thrown outwards, [see direction of arrow below *c*], returning again to its former position at the lowering of the griffe. *f* indicates the place where the triangular lever is fastened (movable) to the projecting bolt, extending out of the frame. *a* indicates the place for the cylinder. Part 1 of the batten is movable at *l* in the direction of arrow, *s*, allowing the cylinder to be inserted. Part 1 is fastened (after putting the cylinder in at *a*), to 2 by means of the screw, *u*.

### THE CYLINDER.

Fig. IX. represents the cylinder, with the lantern for turning the same by means of the catches. The dimensions for the cylinder in the present machine are as follows :

|                            |   |                        |
|----------------------------|---|------------------------|
| Height of cylinder,        | = | $2\frac{7}{8}$ inches. |
| Width " "                  | = | 13 "                   |
| " " lantern,               | = | $1\frac{1}{2}$ "       |
| Average length of spindle, | = | 2 "                    |

This cylinder is carried in the batten, the latter moving in the groove provided for it under 10, Fig. I. This batten has sufficient vibratory motion to enable it

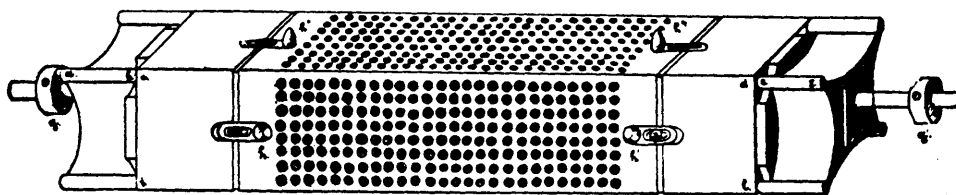

FIG. IX.

to move the required distance away from the needle-board. After coming in contact with the catch it still moves until the cylinder has performed a complete turn. The cylinder is steadied in the required position by the hammer pressing by the means of a spring towards the lantern from below.

### THE HAMMER.

Fig. X. illustrates the hammer as attached to the batten; *a* to *b*, (equals 3 inches in width in our present illustration), represents the head of the hammer, forming the foundation for steadying the cylinder in its turning. The hammer is pressed for this purpose towards the cylinder by means of the spring, *s* to *r*. Parts *h* and *k* guide the hammer in its up and down movements, and are solid parts of the batten. By turning the cylinder the hammer is pushed down in the direction of the arrow, *l*, thus compressing the spring, which returns to its normal position after the cylinder has completed its turn, ready for being advanced towards the needle-board.

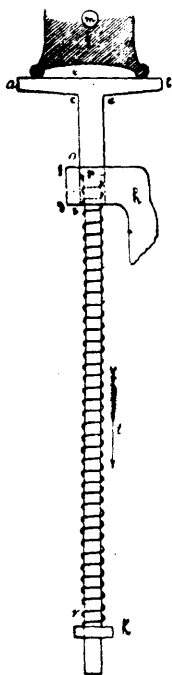

FIG. X.

The following are accurate measurements of this part of the machine :

|   |   |                     |
|---|---|---------------------|
| Height of head of hammer at <i>a</i> and <i>b</i> , | = | $\frac{1}{4}$ inch. |
| Thickness of hammer-head, <i>e</i> to <i>c</i> ,    | = | $\frac{3}{8}$ "     |
| Height of hammer-head when at rest                  |   |                     |
| above the top guiding part, <i>c</i> to <i>a</i> ,  | = | $1\frac{1}{2}$ "    |
| Width of the guiding-rod, <i>c</i> to <i>d</i> ,    | = | $\frac{1}{2}$ "     |
| Thickness of "top guide," <i>f</i> to <i>g</i> ,    | = | $\frac{3}{4}$ "     |
| "    "lower guide," <i>k</i>                        | = | $\frac{1}{4}$ "     |
| Distance between these guides,                      | = | 9 "                 |
| Total height of guiding-rod,                        | = | $10\frac{1}{2}$ "   |

The shaded part of the drawing above the hammer represents the cylinder, *z*, which has its shaft for turning at *m*.

#### THE NEEDLE-BOARD.

As before mentioned, the heads of the needles are passed through the needle-board. A drawing of this board, representing the front view, is shown in Fig. XI.

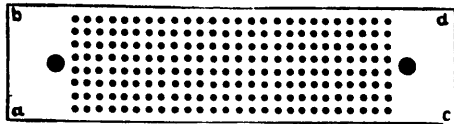

FIG. XI.

The following are the dimensions :  
 $a$  to  $c$ , =  $9\frac{1}{2}$  inches.  $a$  to  $b$ , =  $2\frac{3}{8}$  inches.  
 Each side of the prism, always technically called the cylinder, has a protruding peg about  $\frac{1}{2}$  inch in length. When in contact with the needle-board these pegs enter the black holes shown upon either side in drawing. The 208 needles and holes in the present machine are represented by a small spot for the former with an outside ring for the latter.

The lifting of the griffe, which in turn also operates the other parts of the Jacquard head, as explained before, is not always produced from above: very often this lifting is arranged to be done by means of a lever arrangement from below the griffe. This method of working the mechanism in the Jacquard machine is illustrated by Fig. XII., representing the perspective view of a 400 Jacquard machine.

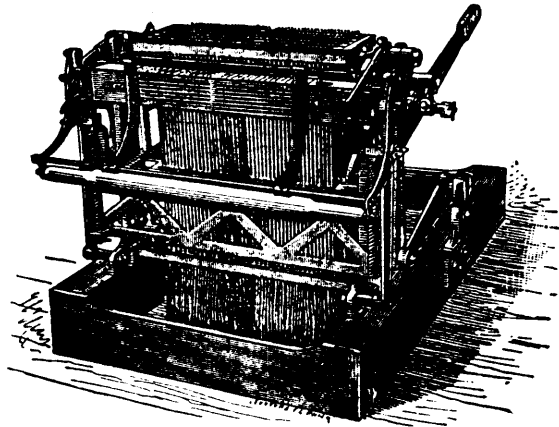

FIG. XII.

Fig. XIII. represents the same machine adjusted to the loom. On the longer arm of the lever a series of holes are found. These regulate the height of the lift by the vertical rod which provides the required movement. The nearer this rod is adjusted to the Jacquard head the higher the lift of the Jacquard harness, thus forming the shed.

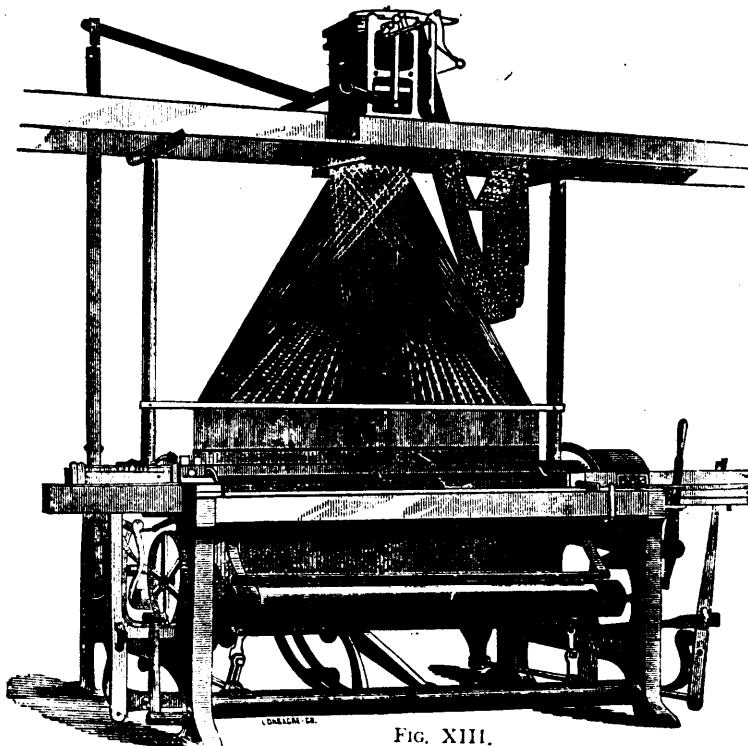

FIG. XIII.

#### THE JACQUARD CARDS.

Fig. XIV. represents a single Jacquard card, as required for the 200 Jacquard.

machine,  $\frac{1}{4}$  of its actual size. This shows 26 rows of holes in its width and 8 rows in its depth, 208 holes. These holes are shown in black, one for each hook in the machine. Besides these a large hole on each side permit the pegs of the cylinder to enter into the needle-board. The cards are interlaced in an endless arrangement.

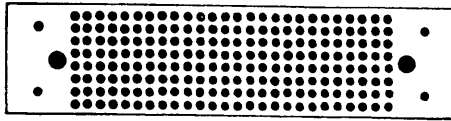

FIG. XIV.

The large holes (marked *d* in drawing) are peg holes to receive the pegs, *h, h', h'', h'''*, etc., of the cylinder, as shown in Fig. IX. These pegs are movable so that any small variations at cutting with different card-stamping machines can be rectified. The paper used for the cards must be of sufficient thickness to resist the wear caused by the needles, as well as to give steadiness to the cards when resting in the pegs of the cylinder.

The cards are interlaced in an endless arrangement; hence, one card is brought after the other in rotation towards the needles. The cards only refuse service by not fitting properly on the cylinder, *i. e.*, if the peg holes are too near together or too far apart; or if the cards are warped, which is liable to happen in a damp workshop.

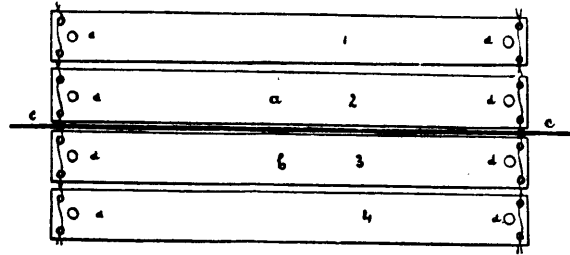

FIG. XV.

A careful examination of the cards fitting on the cylinder is absolutely necessary, otherwise a wrong lifting of the hooks destroying the cards by the pegs punching new holes would result. The cylinder with cards perfectly cut must be set so as to allow the needles to penetrate into the centre of the holes stamped for them in the card. Sometimes the cylinder is set too high or too low—too far in front or too far in rear. To ascertain the proper position, lift the machine and place some paint, or grease from the machine, on the heads of the needles. Afterwards let the machine “fall in,” which will bring the cards against the heads of the needles, producing an impression and indicating the exact position of the needle-heads. The cylinder

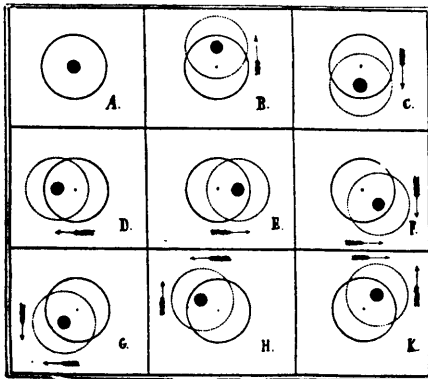

FIG. XVI.

is always set in its proper position when no marks are made by the entering needles on the margins of the stamped holes and where there are no holes the impression left by the needle head must be equally distant from the surrounding holes.

To get a clear understanding of this examine Fig. XVI. illustrating six different impressions of the needles. The circle shown with full lines in each of these six illustrations represents the correct position of the circumference of the hole, and the dotted circles the various errors that may exist.



Fig. A shows the cylinder set in its proper place, which is indicated by the impression of the needle in the centre.

Fig. B shows the cylinder is set too high, as indicated by the impression of the needle. [See arrow.]

In Fig. C the cylinder is set too low.

In Fig. D the cylinder is set too far to the left.

In Fig. E the cylinder is set too far to the right.

In Fig. F the cylinder is set too low and too far to the right.

In Fig. G the cylinder is set too low and too far to the left.

In Fig. H the cylinder is set too high and too far to the left.

In Fig. K the cylinder is set too high and too far to the right.

If the machine produces wrong lifts of the hooks and the trouble is not found in the setting of the cylinder, nor in the hooks or needles, then ascertain if the

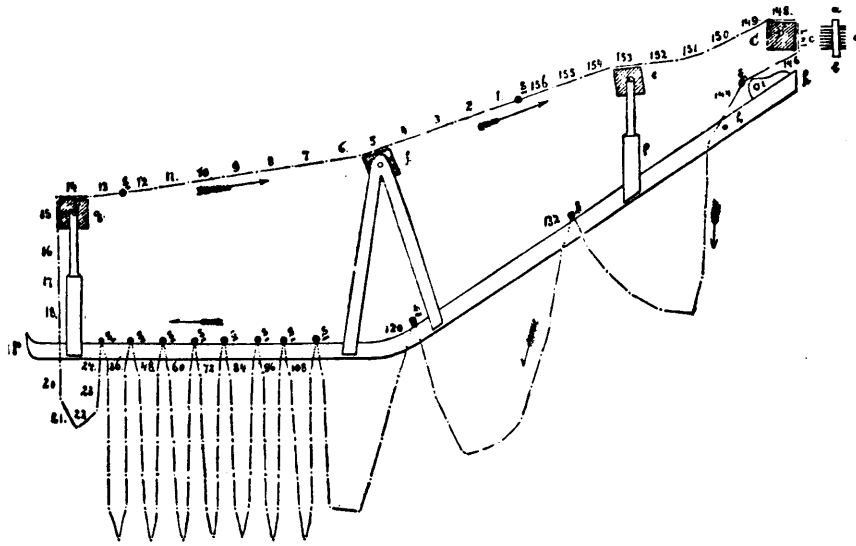

FIG. XVII.

cylinder is adjusted by means of the lever arrangement, close enough to the needle-board; for if it is not, the hooks will not be pushed far enough from the griffe-bars, and by raising the latter a wrong shed will be produced. When using a great number of cards in a set they are made to fold into a "rack." This is done by attaching a wire 1 to  $1\frac{1}{2}$  inches longer than the cards at the junction of, say every 12th, 15th, or 20th cards. [See *c* at Fig. XV.]

The cards fall through a wooden frame, Fig. XVII., but the wires attached to the cards, being longer, can not pass through, and the cards will remain suspended, and subsequently fold together in a very compact manner.

In Fig. XVII. we illustrate 156 cards arranged with wires attached to every twelfth card, as follows: between cards 156 and 1, 12 and 13, 24 and 25, 36 and 37, 48 and 49, 60 and 61, 72 and 73, 84 and 85, 96 and 97, 108 and 109, 120 and 121, 132 and 133, 144 and 145.

At *e, f, g*, are shown prisms of the size of the cylinder, by which the cards are guided and regulated in their run towards the cylinder, (direction of arrow); *i* and *h* represent round rollers, also placed in rack for guiding cards after leaving the cylinder, *c*; *a* and *b*, the needle-board; *c* and *d*, the needles of the machine. *S* represents the wires as inserted in cards for holding them in the frame.

### THE JACQUARD HARNESS.

To the lower end of the hooks (*c*. in Fig. V.) the neck-cords are adjusted. The latter are passed separately through one of the corresponding holes of the perforated bottom board (Fig. II.) To these neck-cords are fastened the leashes of the Jacquard harness about  $\frac{1}{2}$  to  $\frac{1}{4}$  inch above the frame containing the rods which guide the neck-cords vertically as the hooks are raised and lowered. The different harness-cords are threaded through the comber-board in various ways called "Tie-ups," which will be explained later.

#### The Comber-board and Methods of Figuring for it.

There are two kinds of comber-boards used upon Jacquard looms:

- 1st. Comber-boards made of a solid piece of material, either wood or porcelain.
- 2d. Comber-boards made in strips of either of the materials above named, and adjusted afterwards in a wooden frame.

#### Comber-boards Made of a Solid Piece of Material.

Before ordering a comber-board, it is necessary to know the texture of the fabric in the loom, and also the number or size of the machine to be used; for the number of holes per inch in the comber-board is regulated by this. Afterwards, we may, if we choose, arrange the number of holes in depth of the comber-board, according to the number of griffe-bars in the machine, (guided by the fabric to be made). We may have eight griffe-bars in the machine, and arrange the comber-board 4, 6, 8, 10, 12 rows deep; or we may have 12 griffe-bars in the machine, and arrange the comber-board 12, 10, 8, 6, 4 rows deep.

**RULE:** The number of holes to one inch in the comber-board must equal the texture of the fabric to one inch in loom.

**EXAMPLE:** Suppose a fabric with a texture in the loom of 100 threads, and we are to use a 600 Jacquard machine, with 12 rows. The width of the fabric in the loom is to be 36 inches.

*Required:* The number of holes in the width of the comber-board.

*Answer:*  $100 \times 36 = 3600$  holes in the comber-board.

$3600 \div 12 = 300$ , the number of holes in width.

The width and depth of the comber-board are regulated by the width of the cloth required and by the design to be used.

The greater the number of rows in depth the closer they must be; the same is true of the width.

It is necessary to take care not to have the comber-board too deep, as the consequence would be a bad shed; furthermore, we must not have the holes too close together, as in a high texture this would make trouble in the weaving through the catching of the heddles with the warp, and also cause useless chafing of the warp-threads and the heddles.

#### The Changing of Solid Comber-boards for Different Textures.

In Jacquard work we generally use the same texture, or as near as possible, as the loom is tied up for; but changes are sometimes unavoidable. If we reduce the texture of the fabric in a Jacquard loom tied-up for a solid comber-board, we must reduce proportionally the number of hooks and needles used in designing, and hence the number of heddles used per inch. These heddles will thus be left empty when drawing in the warp. To accomplish this lift the full machine and throw the hooks not to be used from the knives, lowering in this way every mail which is not to be used. Sometimes there may be only one, two, three, or four hooks to be thrown off, on account of the design. At other times it may be necessary that one-eighth, or one-fourth, or even one-half of the whole number shall be dropped for this purpose. For instance, suppose we have a dressgoods design of 596 threads and a 600 machine. These four ends left off the 600, if in 6, 7, 8, or more inches in width, would not affect the fabric nor the cost to any great extent; hence we may leave out the first or last four needles of the 600.

Suppose we have a texture of 100 in the comber-board, to lower to 66 ends per inch. 66 ends, or the nearest even part of 100 ( $66\frac{2}{3}$ ) is  $\frac{2}{3}$  of 100; hence, we only need two-thirds of our machine; and as the same is supposed to be arranged 12 rows deep, we need  $\frac{2}{3}$  of 12 rows, or 8 rows. The four rows thus found necessary to drop may be dropped from the ends, or alternately, as follows:

Every alternate 2 rows taken, 1 row missed, 4 times over, = 12 rows. Or, 2 rows missed, 8 rows taken, 2 rows missed, = 12 rows.

#### Comber-boards made in Strips and Adjusted afterwards in a Frame.

By these comber-boards which are used to a great advantage on narrow loom work up to 36 inch fabrics, we can change the texture for the fabric; for the strips composing the comber-board may be drawn apart, thus changing the higher texture to lower; whereas in a solid comber-board this could only be done by re-tying the harness or changing the number of needles used in the machine. To give a clear understanding Figs. XVIII., XIX., XX. are needed.

Fig. XVIII. represents an 8-row deep comber-board, *a, b, c, d*, composed of 10 strips which are set close together. By examining each strip 5 cross-rows of holes will be found, making the whole number of holes 400.

Suppose the comber-board as represented in Fig. XVIII. is intended for a texture of 100 ends per inch; this will give for the width of the fabric (*i, k, to l, m,*) 4 inches.

In Fig. XIX. the comber-board is arranged for a texture of half as many ends, or 50 holes per inch, and the 10 strips are arranged accordingly; the empty places

FIG. XIX.

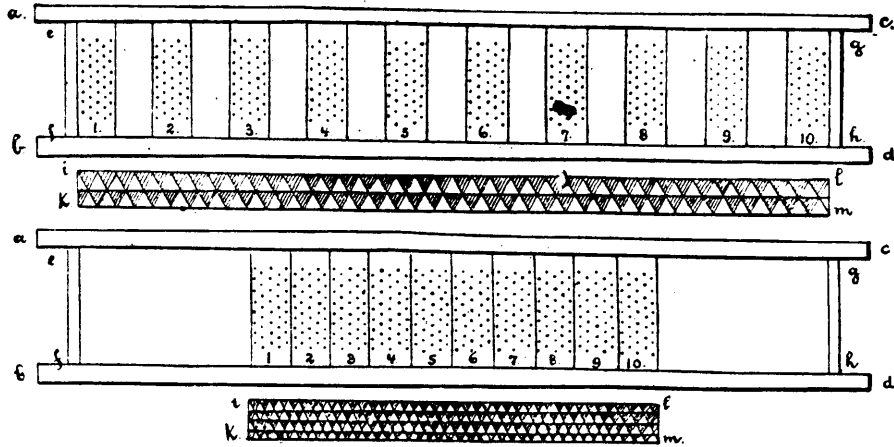

FIG. XVIII.

between the strips are of same size as the strips themselves, and the fabric design below the comber-board is arranged to correspond.

Fig. XX. illustrates the sectional cut of the comber-board used in drawings, Figs. XVIII. and XIX., and the letters indicating the different parts of these figures which correspond.

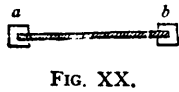

FIG. XX.

**Divisions of the Comber-board.**

Under this heading we classify one repeat of the arrangement of threading harness-cords in the comber-board, and therefore one repeat of the design of the fabric. We find fabrics in which are used one or more divisions of one system of threading harness-cords in the comber-board; again, there are others in which one or more divisions of one system are combined with one or more divisions of another, or even of two or three other systems.

**Heddles for the Jacquard Harness.**

After the harness-cords are threaded through the comber-board the heddles are adjusted. Of these there are two kinds:

A. The twine heddle, containing the mail for holding the warp-thread.

B. The wire heddle, similar in its construction to the regular heddle, used in the common harness-loom. These are very little used, and only in fabrics of a low texture.

Fig. XXI. illustrates a regular twine heddle one-fourth of its actual size.

b represents the mail, through the eye of which the warp-threads are passed.

a, the adjustment of the heddle to the harness-cord.

c indicates part of the lingo for weighting the heddle.



FIG. XXI.

Fig. XXII. illustrates the method observed for combining heddle and harness-cords. *a*, the guide-board, to get the mails regular in height; *b*, the knot combining heddle and harness-cord. [See *a* in Fig. XXI.] *c*, the mail. *d*, the lingo.

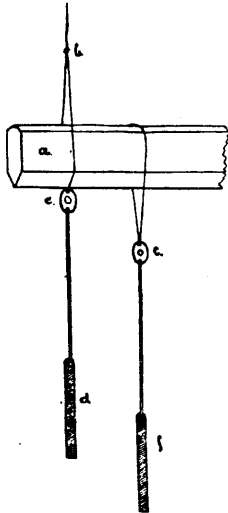

FIG. XXII.

Fig. XXIII. illustrates the average position of the mail in a loom. *a*, breast-beam of the loom. *c*, the warp-beam or guide-beam over which the warp runs on its way towards the harness. *b*, the position of the heddle. *d*, the lingo.

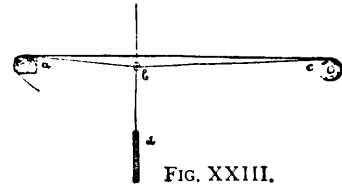

FIG. XXIII.

### The "Leasing" of the Harness.

This requires a clear conception of the rotation in which the different heddles are threaded, according to the tie-up employed. Two methods are in use: 1st. The heddle nearest the weaver is the first to be threaded, and the heddle of the same row in rear of the comber-board is the last. 2d. This principle reversed, thus arranging the leasing from rear to front.

The latter method is the one most generally observed. Every row in depth of comber-board is leased separately, and in rotation secured to the lease-twines, *a* and *b*, in Fig. XXIV., thus forming an uninterrupted line of heddles through the entire Jacquard harness. Through these heddles the warp is afterwards drawn in rotation.

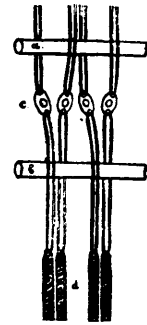

FIG. XXIV.

### TYING-UP OF JACQUARD HARNESS.

#### 1. The Straight-Through Tie-up.

This tie-up contains in its principle the foundation of all the others. Three methods are in common use, which we will now explain.

#### 1st. The Jacquard Harness threaded on the machine in the direction from Front to Rear.

This tie-up is represented in Fig. XXV.

As mentioned in the heading of this article, the Jacquard harness, or the leashes, are fastened to the machine in rotation from front to rear, the threading of the comber-board being done from rear to front. The comber-board is in three divisions. The machine used for illustrating is a 400 Jacquard 8-row machine, and the comber-board used is also 8 rows deep. This method of tying-up of the leashes forms what is technically known as "open harness." As the drawing is designed to explain a 400 machine, 8 rows drawn in the comber-board, also 8 rows deep, one row in height of the cylinder will equal one row in depth on the comber-board. In examining the illustration the eye must follow the line connecting the

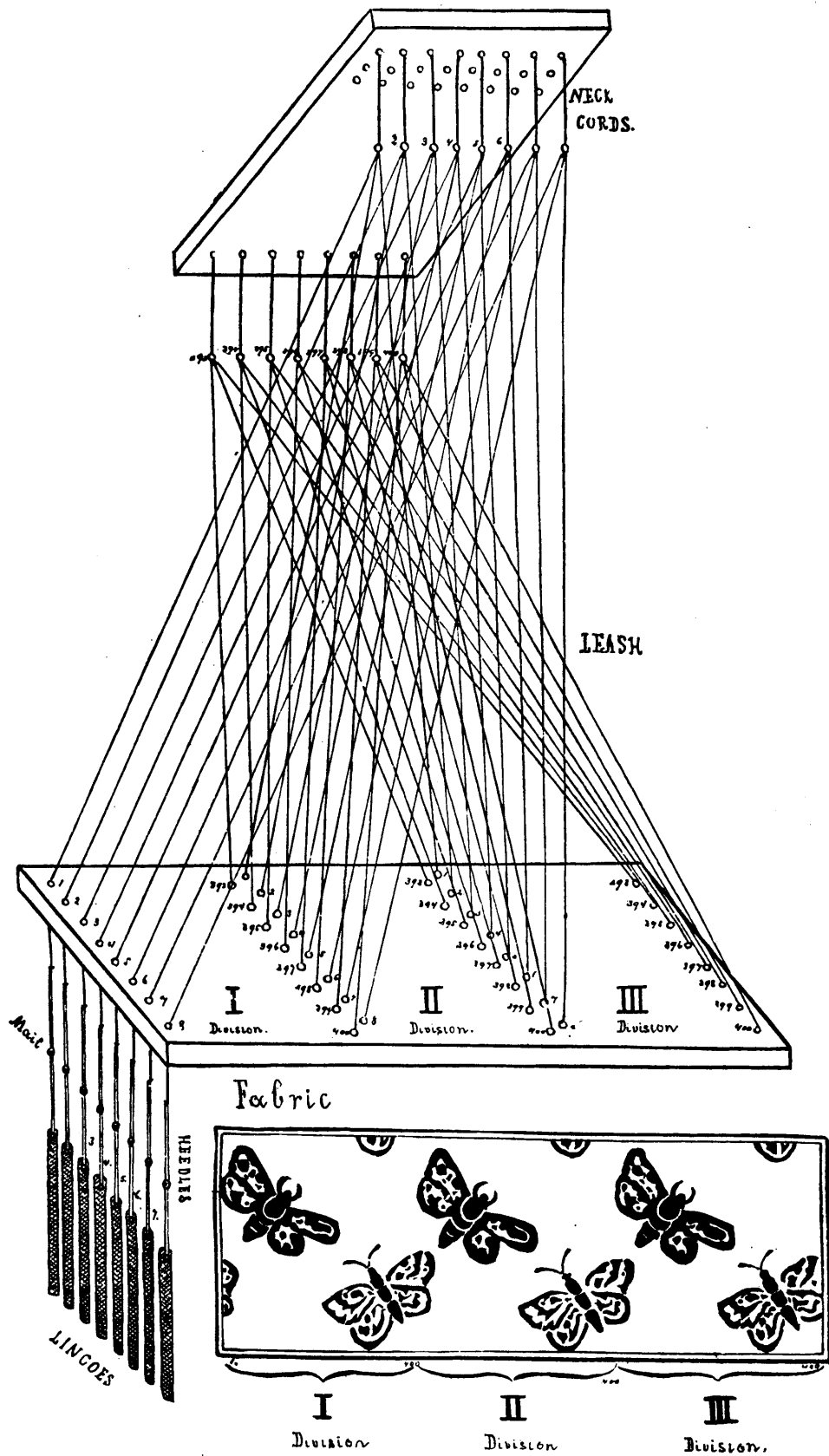

FIG XXV.

numbers on the neck-cords to the corresponding numbers near the holes on the comber-board. If this be done, the tie-up will readily explain itself. It will also explain the method of procedure if a machine is used containing a different number of needles and hooks, and a comber-board having as many rows in depth as there are griffe-bars in the machine. For example, a 600 machine, with 12 griffe-bars, needs for this tie-up a comber-board 12 rows deep; and a 200 machine, with 8 griffe-bars, requires a comber-board 8 rows deep, etc., etc.

The drawing shows a comber-board with 3 divisions, each division furnishing one harness-cord to each neck-cord, making in all three harness-cords to every neck-cord. The same tie-up will apply should the drawing contain a different number of divisions. The illustration shows only the first and last rows of each division in the comber-board, and also the first and last rows of neck-cords.

The design below the drawing represents a damask fabric to be executed on this tie-up, requiring the whole number of needles for one repeat of the pattern of 400 threads. In designing for these tie-ups it is necessary to arrange the design to repeat itself in the number of needles that will be used in producing the fabric.

The first and last threads must connect with each other, without interruption, forming a continuous design over all the divisions. Thus we find, in fabric design of a damask towel, Fig. XXVI., the repeat (division) from *A* to *B*. In the centre of the design marked *a*, and the main part of the border marked *c*, we find one repeat; whereas borders *b* and *b'* repeat 8 times.

In the fabric illustrated by design, Fig. XXVII., again a damask towel, the repeat, or one division, is also indicated by *A* to *B*. The centre of the fabric, *a*, repeats twice in one division; borders *b* and *b'* repeat four times in the same distance; whereas the main design of the border indicated by *c* requires one complete division.



FIG. XXVI.

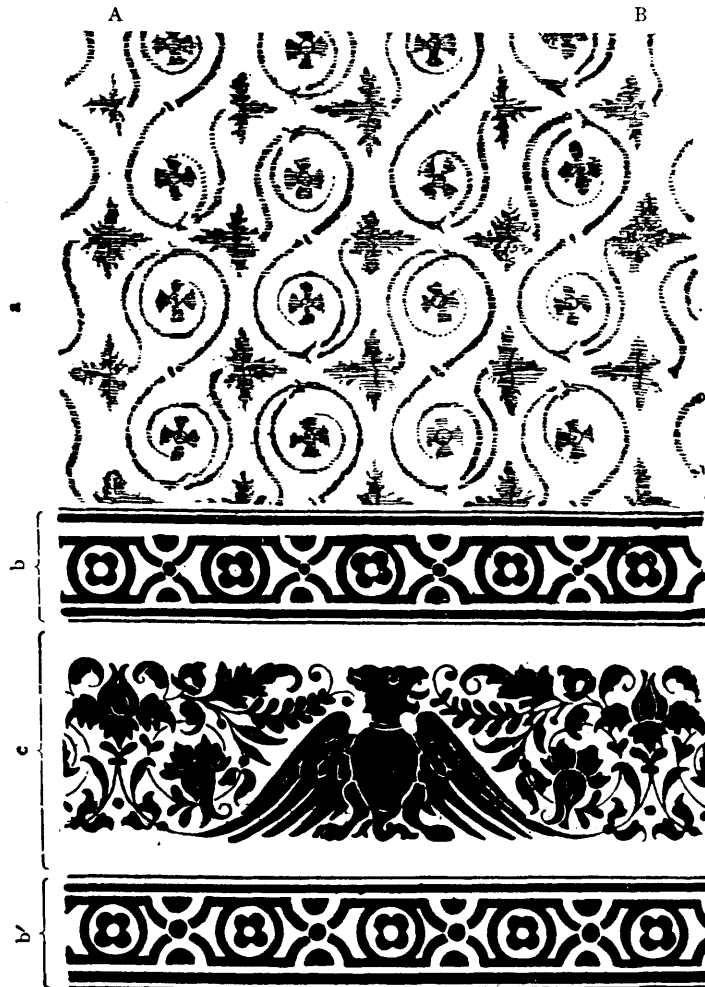

FIG. XXVII.

2d. The Jacquard Harness threaded on the machine from Rear to Front.

This is the second method for the straight-through tie-up, and is illustrated in Fig. XXVIII. The Jacquard harness is fastened to the machine, at the neck-cords, from rear to front. The threading of the comber-board is also from rear to front. In this method the work of attaching the leashes to the neck-cords is commenced in the rear instead of the front of the machine, thus giving a different view and arrangement of the tie-up. This disposition of the threads is called a "sectional harness arrangement."

The illustration shows a 400 Jacquard or 8-row machine, in connection with an 8-row deep comber-board, with one row in the comber-board requiring a corresponding row on the face of the cylinder. It will also explain the method of procedure with this tie-up in Jacquard machines with comber-boards of different sizes.

Fig. XXIX. represents the perforated board at the bottom of the machine through which the neck-cords pass, attaching the leash to the neck-cords. The first row, containing neck-cords numbered 1, 2, 3, 4, 5, 6, 7, and 8, and the 50th row, containing those numbered 393, 394, 395, 396, 397, 398, 399, and 400, are the only ones shown in Fig. XXVIII. illustrating the tie-up. The comber-board is divided



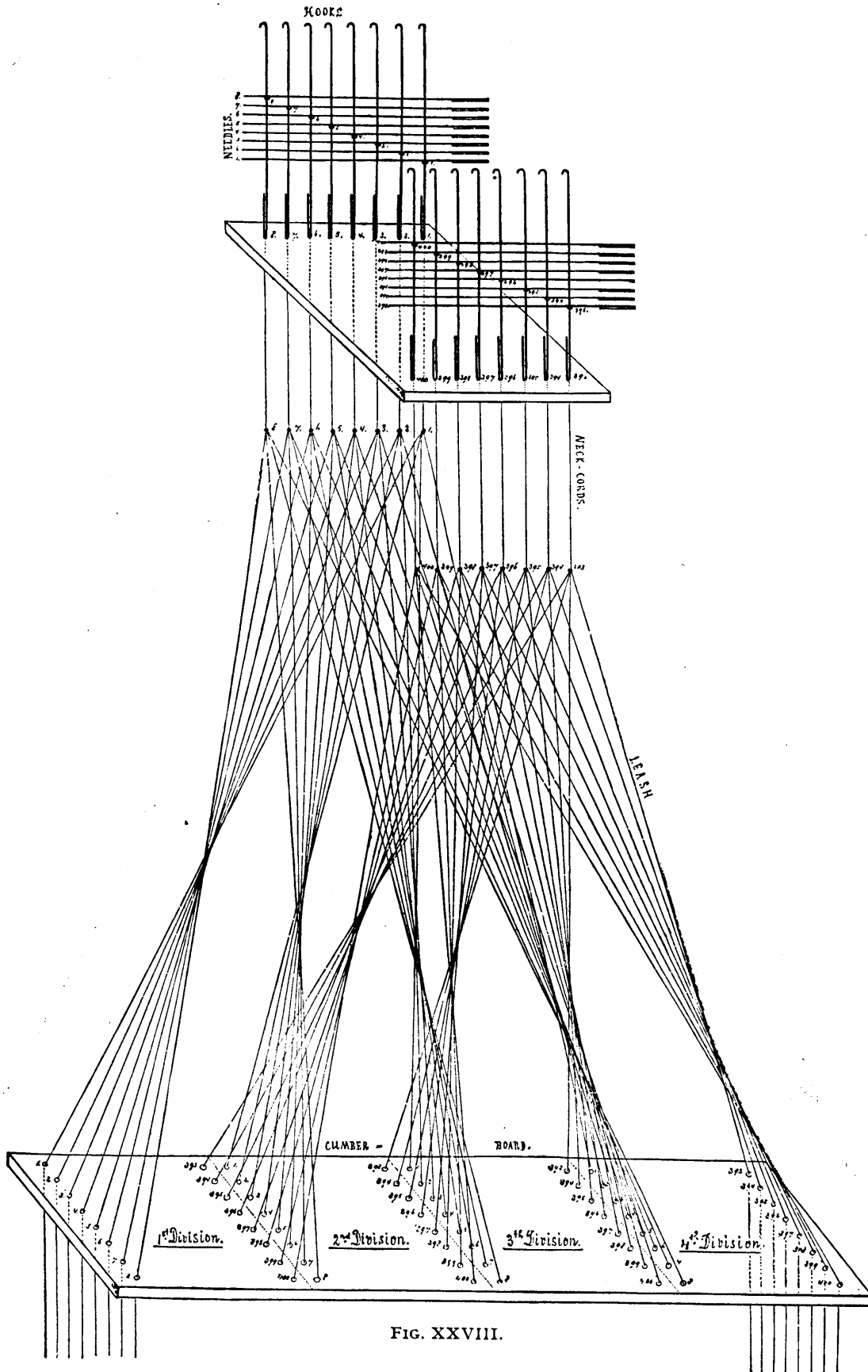

into four sections ; hence, the drawing, as represented in Fig. XXVIII., calls for a fabric with 1600 ends in width. 400 ends, or any number dividing into 400, can be used for the repeat of the pattern. The method followed in the illustration may be applied to any size of Jacquard machine, and also to any required number of divisions in the comber-board.

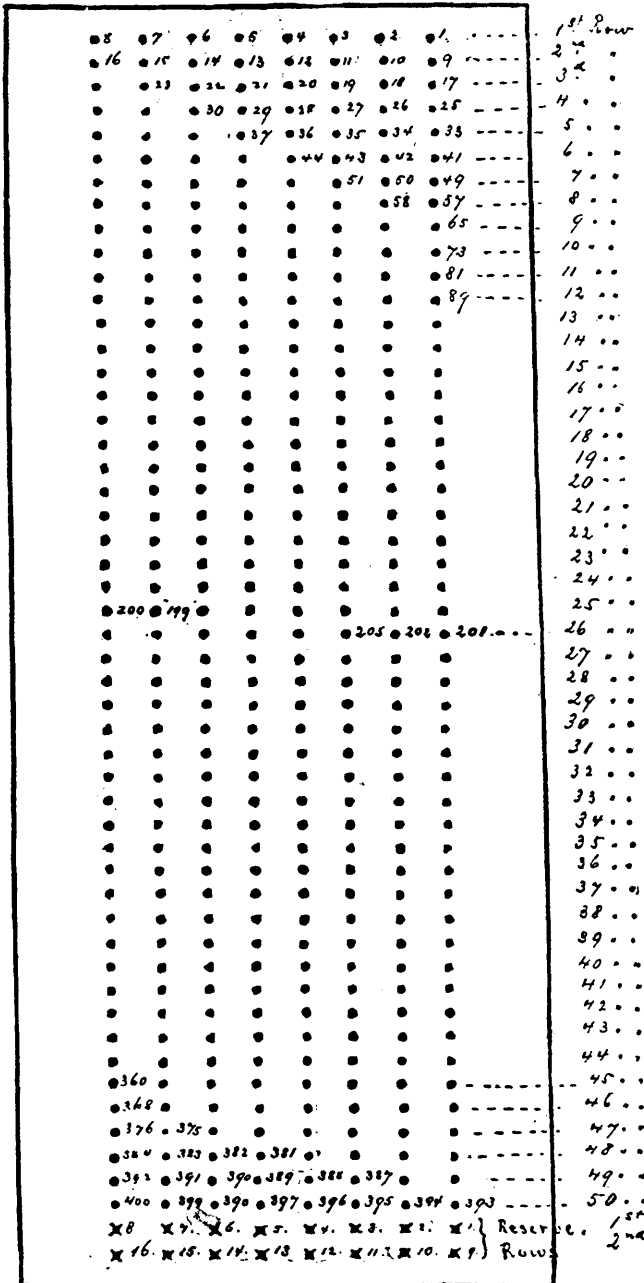

FIG. XXIX.

The 8 hooks of one cross-row (one hook from each of the 8 griffe-bars) run in the same thing, running in the direction of the width of the fabric. [See Fig. XXX.]  
The 8 hooks of one cross-row (one hook from each of the 8 griffe-bars) run in the

In ascertaining the number of hooks or needles for one repeat of the design, determine accurately if the repeat of the weave employed for binding *the ground* or the figure divides evenly into this number. For example, take bottom board, Fig. XXIX., calling for 400 hooks and 400 needles. Suppose the ground weave to be an 8-leaf satin, and the design to repeat once in the 400 hooks.  $400 \div 8 = 50$  repeats, showing an equal division. But suppose a 12-leaf satin is used; it is obvious that 12 is not an even factor of 400, as the division shows a remainder of 4. To dispose of this remainder two methods are open :

First. Omit last 4 ends and use only 396 hooks, a multiple of 12, giving 33 repeats ; or,

Second. Add 8 hooks from the reserve rows, elsewhere previously alluded to, thus increasing the number to 408, which is also a multiple of 12, giving 34 repeats.

3d. The Straight-Through Tie-up on the English System.

The English system, which is widely used, has the Jacquard machine so adjusted upon the loom as to have the cylinder lengthways, running in the same direction as the comber-board ; or, what is the

direction from the cloth beam towards the warp beam. Having the same number of rows in depth, in comber-board as there are griffe-bars, one may readily see the advantages of this tie-up. The first row in depth of the comber-board contains harness-cords from neck-cords 1 to 8. The second row deep of comber-board contains harness-cords from neck-cords 9 to 16, finishing each division on the last (25th) row, with harness-cords from neck-cords 193 to 200.

Should we have a 600 machine, with 12 rows, the comber-board would also have 12 rows, as the 600 machine contains 12 griffe-bars. The first row of the comber-board receives the harness-cords from Nos. 1 to 12; the second row from Nos. 13 to 24, and so on, finishing on the last (50th) row of comber-board with 589 to 600.

## II. Straight-Through Tie-up for Repeated Effects, in one Repeat of the Design.

This method of arranging the tying-up of the Jacquard harness is based upon the necessity for producing patterns having a larger number of warp-threads than the Jacquard used has needles. The principle to be observed is found in producing small effects which repeat themselves in the general design.

The number of cords for the leashes depends upon the frequency with which these repeats occur. Fabrics with stripe effects offer greater opportunities for reducing the number of hooks and needles than other designs. Fig. XXXI. illustrates such a design with its tie-up, using a 400 Jacquard machine with 8 rows. The pattern shows four distinct effects, as follows :

- A*, requiring rows 1 to 16, inclusive ; or harness-cords 1 to 128, inclusive.
- B*, requiring rows 17 to 21, inclusive ; or harness-cords 129 to 168, inclusive.
- C*, requiring rows 22 to 34 ; or harness-cords 169 to 272, inclusive.
- D*, requiring rows 35 to 50 ; or harness-cords 273 to 400, inclusive.

In this fabric we find 2 full repeats of the design: first, *E* to *F*; second, *E'* to

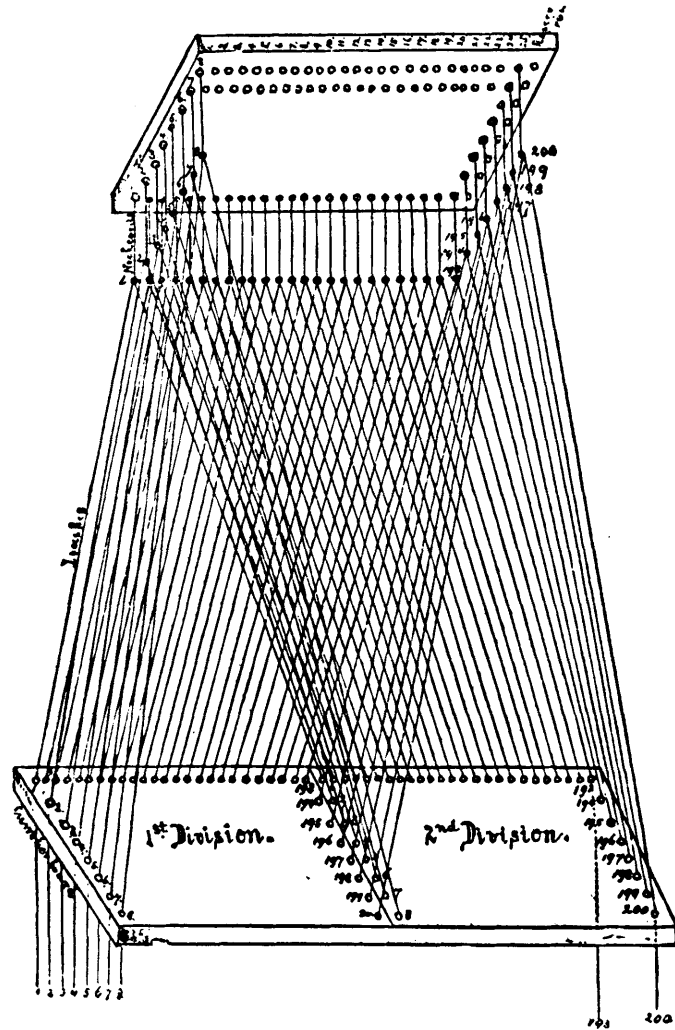
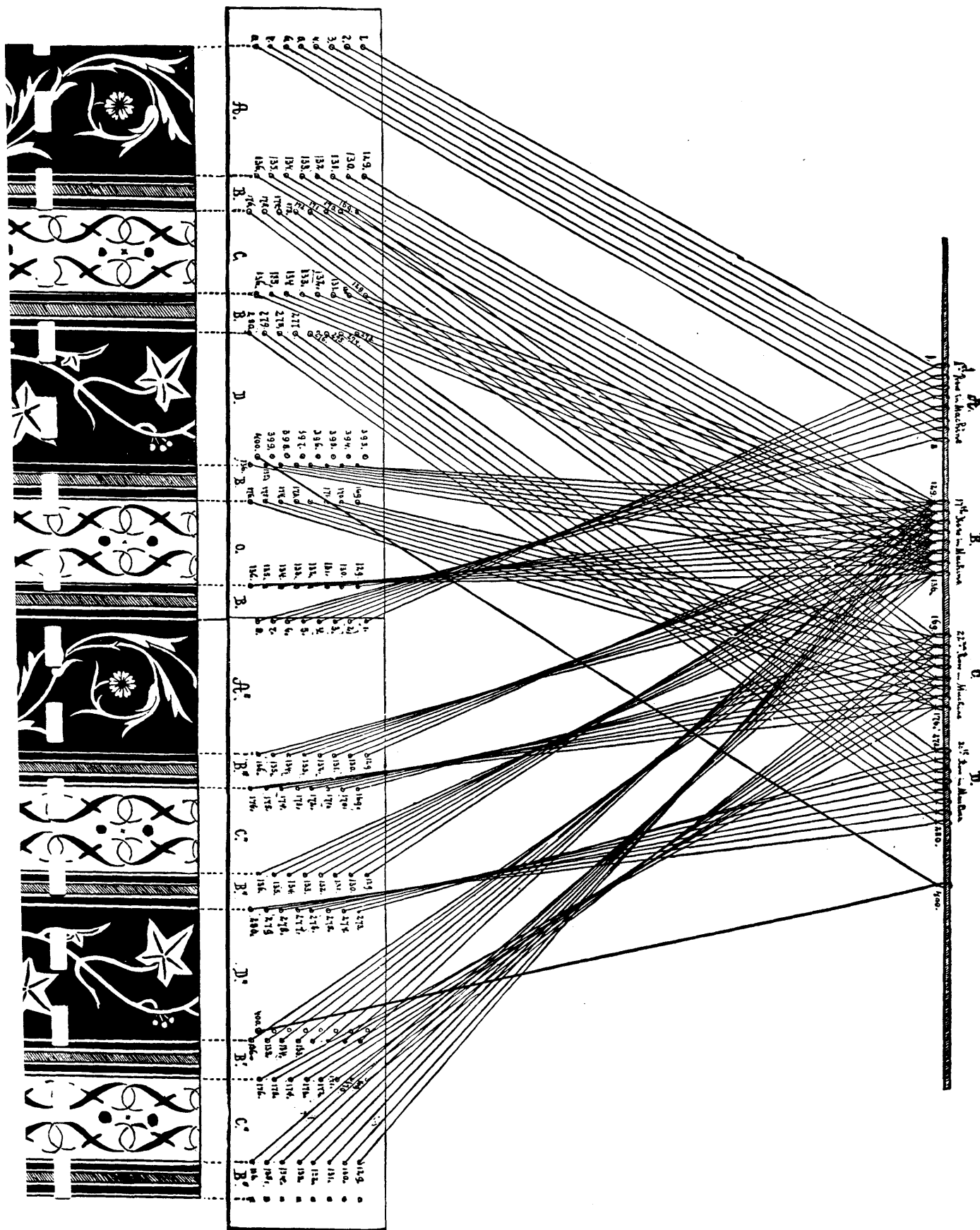

FIG XXX.



$F''$ , thus requiring two divisions in the comber-board, as indicated by the vertical line between  $F$  and  $E''$ .

The next subject to consider is the different arrangement of repeated effects in one division. Commence at the left-hand side of the fabric sketch with effect  $A$ , which repeats only once in one pattern or one division. The illustration shows two divisions, and also that each hook of rows 1 to 16, inclusive, in the first division can be connected with each hook of rows 1 to 16, inclusive, in the second division, because these rows produce the same effect in the design, which repeats itself in these two places. This connection forms what is technically called a leash, and it will always be found that for every harness-cord a leash contains, there will be found a repeat in the design to correspond.

Effect  $B$  is repeated four times in the design, or in each division. By having two divisions for the illustration we find that to produce the necessary repeats in the design each hook of rows 17 to 21, inclusive, requires 8 harness-cords to each leash.

Effect  $C$  repeats twice in one pattern or one division. Having two divisions for the illustration, each hook of row 22, including row 34, requires 4 harness-cords to each leash.

Effect  $D$  repeats once in pattern, once in division. This will give a result similar to  $A$ , two divisions, row 35, including row 50, with two harness-cords to each leash. This tie-up illustrates the first row of every effect, and also the last leash, 400.

Adding the number of warp-threads in the full repeat of the pattern, we have:

Effect  $A = 128$  threads.

“  $B = 40$  “

“  $C = 104$  “

“  $B = 40$  “

“  $D = 128$  “

“  $B = 40$  “

“  $C = 104$  “

“  $B = 40$  “

---

624 threads.

Or, in other words, we are producing with a “straight-through tie-up for repeated effects” on a 400 Jacquard machine, a design, which would require a 600 machine on a common straight-through tie-up, including the two reserve rows, or 624 needles; in other words, a saving is made of 224 needles in one full repeat of the pattern.

In designing for looms tied up for similar styles, the repeats of effects must be kept in mind. The general style of every design may be changed, but the arrangement of the repeated effects cannot be altered without changing the entire Jacquard harness.

### III. Straight-Through Tie-up of a Jacquard Loom having Front Harness Attached.

As mentioned in the beginning of this work, every Jacquard machine contains two reserve rows, which may be used for various purposes. One of the purposes to which these rows are frequently put is the enlargement of the design of the fabric by using harness on the front of the comber-board, technically known as "front harness." For example, in damask table-cloths, we may use the Jacquard harness for producing the border of the fabric. The centre part may be produced with front harness, forming a checkerboard, or some similar effect. This process may be reversed by designing the centre of the table-cloth for the Jacquard harness, and the border for the front harness.

A third method is to design part of the centre and part of the border for the Jacquard harness, the other parts being designed for the front harness. This tie-up is also used to a great extent in the manufacture of dressgoods, etc., where stripe effects produced by the front harness, alternate with floral or geometrical designs produced by the Jacquard harness.

In Fig. XXXIII. the centre of a table-cloth cover is shown to further illustrate this method of tying-up. One-half of the width of the design is for the Jacquard harness; the other half is for the front harness. To produce the required checkerboard effect these front harness are used here in two distinct sets.

The 1st set = 5 harness, working on the 5-leaf satin warp for face, alternating with the

2d set = 5 harness, working on the 5-leaf satin filling for face.

If only 8 front harness should be used for the design, we should have the 1st set = 4 harness, working on the 4 harness broken twill warp for face.

2d set = 4 harness, working on the 4 harness broken twill filling for face.

Set 1 to alternate with set 2 to form the check. Care must be taken that the number of checks formed by the front harness are evenly arranged to the figured part of the fabric. For example, Fig. XXXIII., in the front harness part of the design shows 5 warp checks and 5 filling checks in one row, = 10 checks.

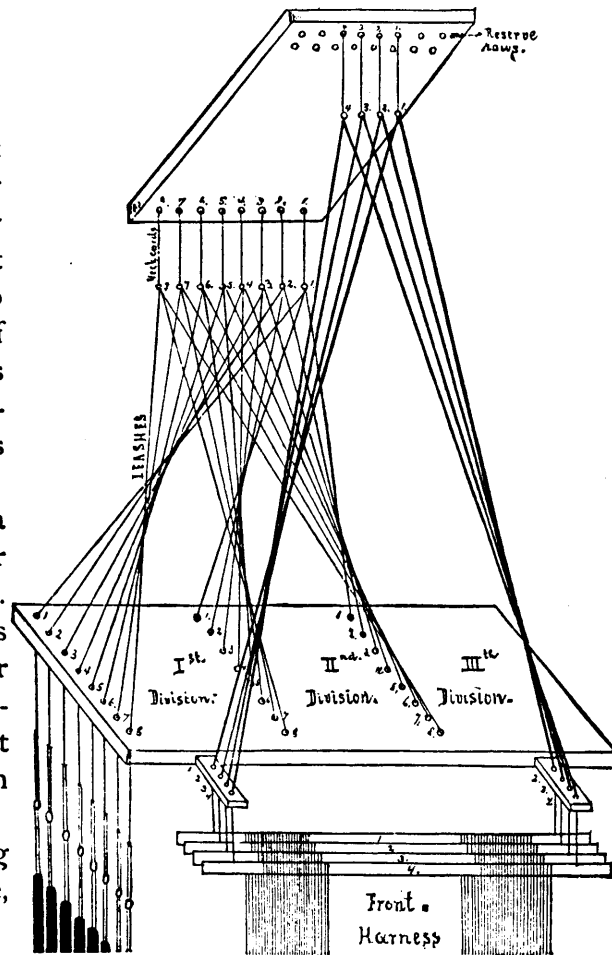

FIG. XXXII.

Suppose 10 front harness are used and 20 warp-threads allowed for each check; then  $20 \times 10 = 200$  warp-threads, all used for effects by the front harness.

This requires 200 warp-threads for figure effects to be used by the Jacquard harness.

The repeat of the pattern is therefore 400 warp-threads, which is produced by straight-through tie-up, front harness attached, with 200 hooks and needles for FIGURE PART of the design, plus 10 hooks and needles for CHECKERBOARD PART of the fabric taken from the 16 hooks and needles of 2 reserve rows, leaves 6 hooks and needles for selvedge, etc.

As previously stated, the front harness may be used for dressgoods fabrics. In this way the design may be enlarged to any required extent.

Fig. XXXII. illustrates this method, using an 8-row Jacquard machine, with 4 front harness adjusted, in common use for the manufacture of dressgoods fabrics, damásk's, etc.

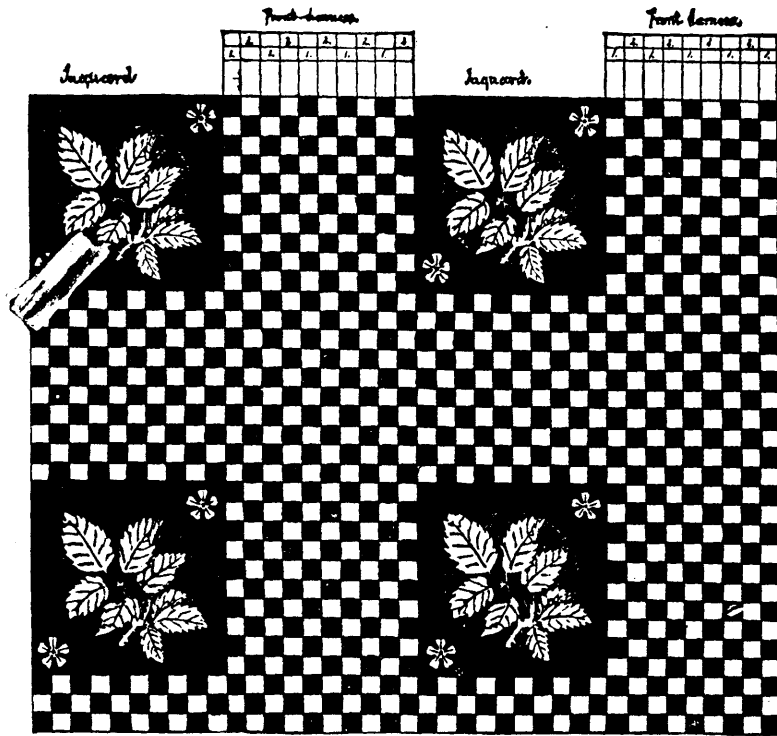

FIG. XXXIII.

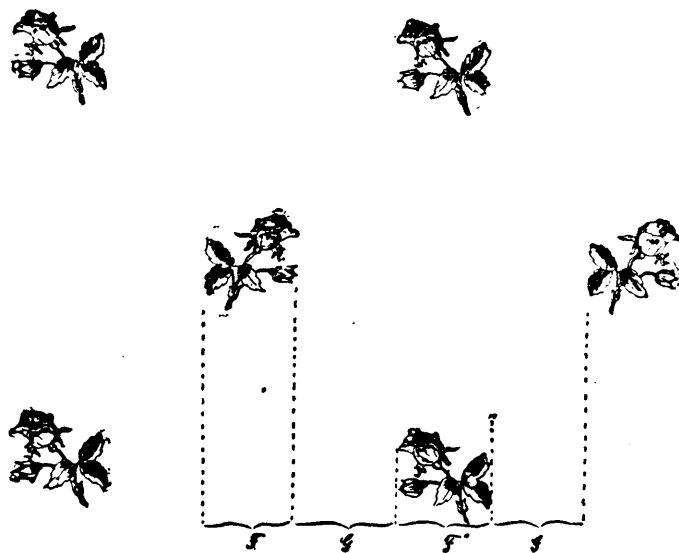

FIG. XXXIV.

Fig. XXXIV. shows a fabric designed for dressgoods forming an all-over-set pattern. In this design parts *F* and *F'* must be executed with the Jacquard leashes; parts *G* and *G'* can be executed with front harness. For example: parts *F* and *F'* require each 100 hooks, the ground part to be woven in 4 harness broken twill. We find the answer as to number of warp-threads in the repeat and number of hooks required for weaving as follows :

$F = 100$  threads.  
 $G = 100$  " (because covering the same distance as  $F$  in part of the fabric.)  
 $F'' = 100$  "  
 $G = 100$  "  

---

 400 warp threads in repeat.

$F = 100$  hooks.  
 $F'' = 100$   

---

 200 hooks for figure.  

---

 4 hooks for weaving the ground, front harness.  

---

 204 hooks required to weave design, Fig. XXXIV., repeating with 400 warp-threads.

#### IV. The Centre Tie-up.

The centre tie-up, also called the point tie-up, has for its purpose the enlargement of the design in fabrics such as table-covers, dressgoods, etc. This tie-up resembles in its principle that of a common point-draw on the harness-loom. After drawing

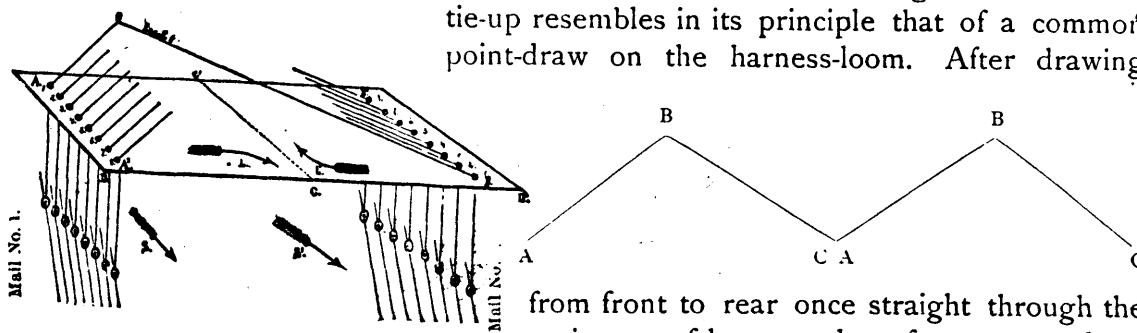

FIG. XXXV.

from front to rear once straight through the entire set of harness, draw from rear to front and repeat. The only difference between harness-work and Jacquard work is in the fact, that with harness we commence to draw in from the first harness straight through to the last,  $A$  to  $B$ , and back again,  $B$  to  $C$ ; but with the Jacquard tie-up on this method this is arranged through the threading of the comber-board, having a straight-through leasing of the heddles and drawing in of the warp.

In Fig. XXXV. there is a clear illustration given of the principle of the centre tie-up on an 8-row comber-board  $A, A', B, B'$ . In laying out the comber board, it must be divided by the line  $C, C'$ , into two equal parts,  $D, C$ , and  $C, D'$ . In the part  $A, A', C, C'$ , of the comber-board, we commence threading with leash 1 at the left-hand rear corner, running in succession towards the centre, as indicated by the arrow on this part of the comber-board.

In part  $B, B', C, C'$ , the threading begins in the opposite corner, to the right-hand in front, with number 1 leash, threading in rotation the number of leashes from the front towards the rear, as again indicated on the figure by an arrow. After leasing and threading the harness, No. 1 leash will contain in its two mails the first and the last of the warp-threads, as indicated in Fig. XXXV. by the numbers, and the rotation by the arrows,  $S$  and  $S'$ .



Fig. XXXVI. represents this centre or point tie-up applied to a 200 Jacquard machine; comber-board, 8 rows deep; two full divisions; *A, B*, the first division; *B, D*, the second division; *C* and *C'* forming the centre in each division. This machine will, if tied-up in this manner, produce a design requiring 400 warp-threads. We must arrange the design for this tie-up so as to repeat forwards and backwards respectively in the centre. Such a design will run upwards at a given angle to a definite point, then it will return by the same angle in an opposite direction until it reaches the base from which it originally started.

In this manner design, Fig. XXXVII., is constructed. *A, B, C, C', D*, correspond with the same letters used in Fig. XXXVI.; hence, it will readily

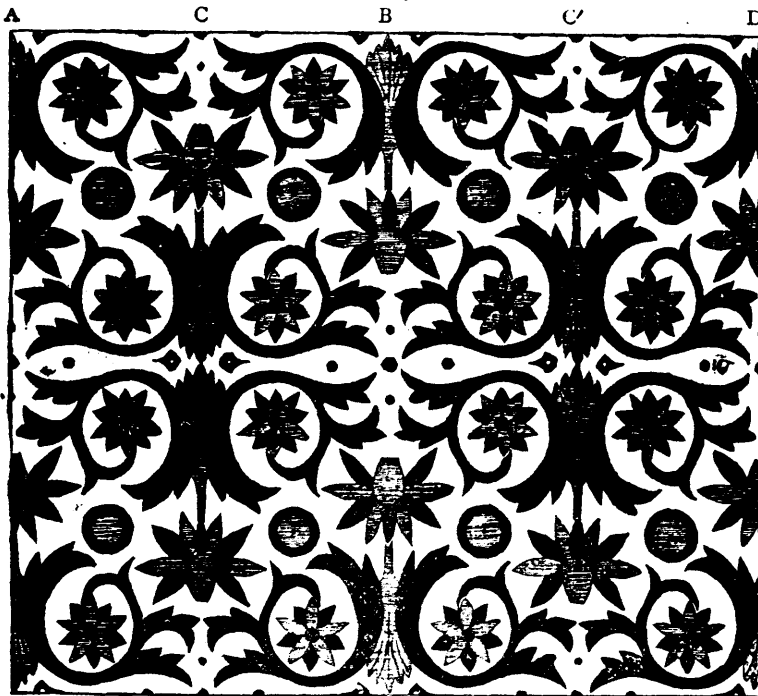
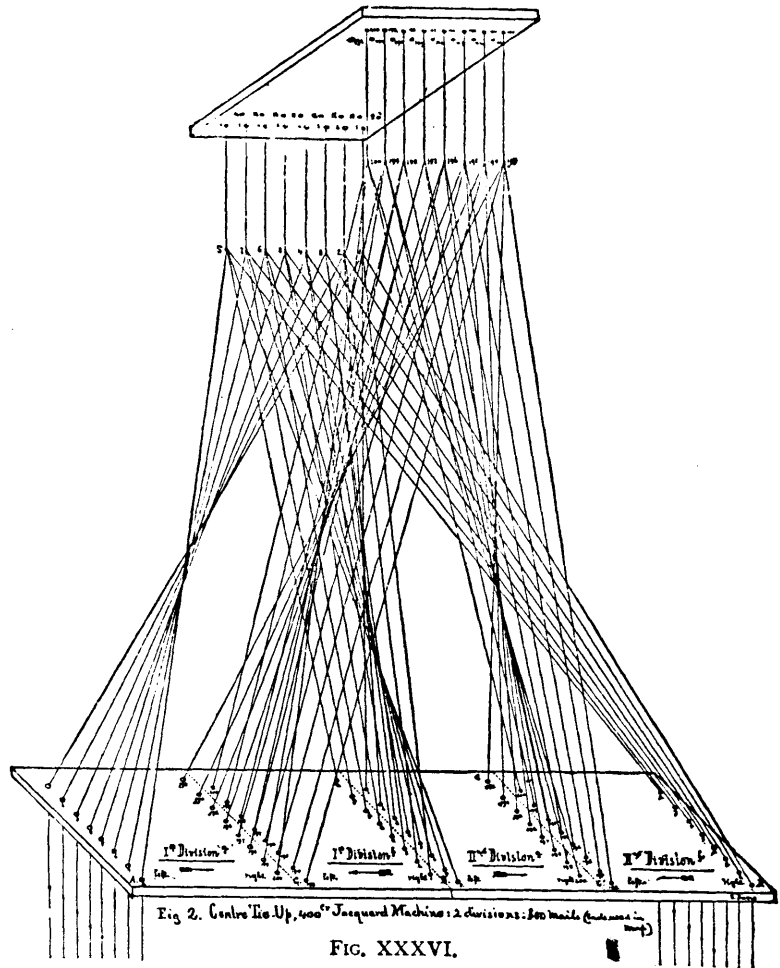

FIG. XXXVII.

explain itself, as well as the method to be observed in designing for this kind of tie-up. The design runs straight through from *A* to *C*, and repeats itself backwards from *C* to *B*, finishing at *B* the first full division.

$$\left. \begin{array}{l} B-C \text{ equal } A-C, \\ C-D \text{ " } C-B, \end{array} \right\}$$

forming the second division.

Any changes as to different sizes of machines, rows deep of comber-board, or number of divisions, must be executed upon the principle explained in this article.

V. "Straight-Through" and "Point" Tie-ups Combined.

A.—For fabrics requiring for their centres a straight-through tie-up and for their borders a point tie-up, one-half division of it for each border.

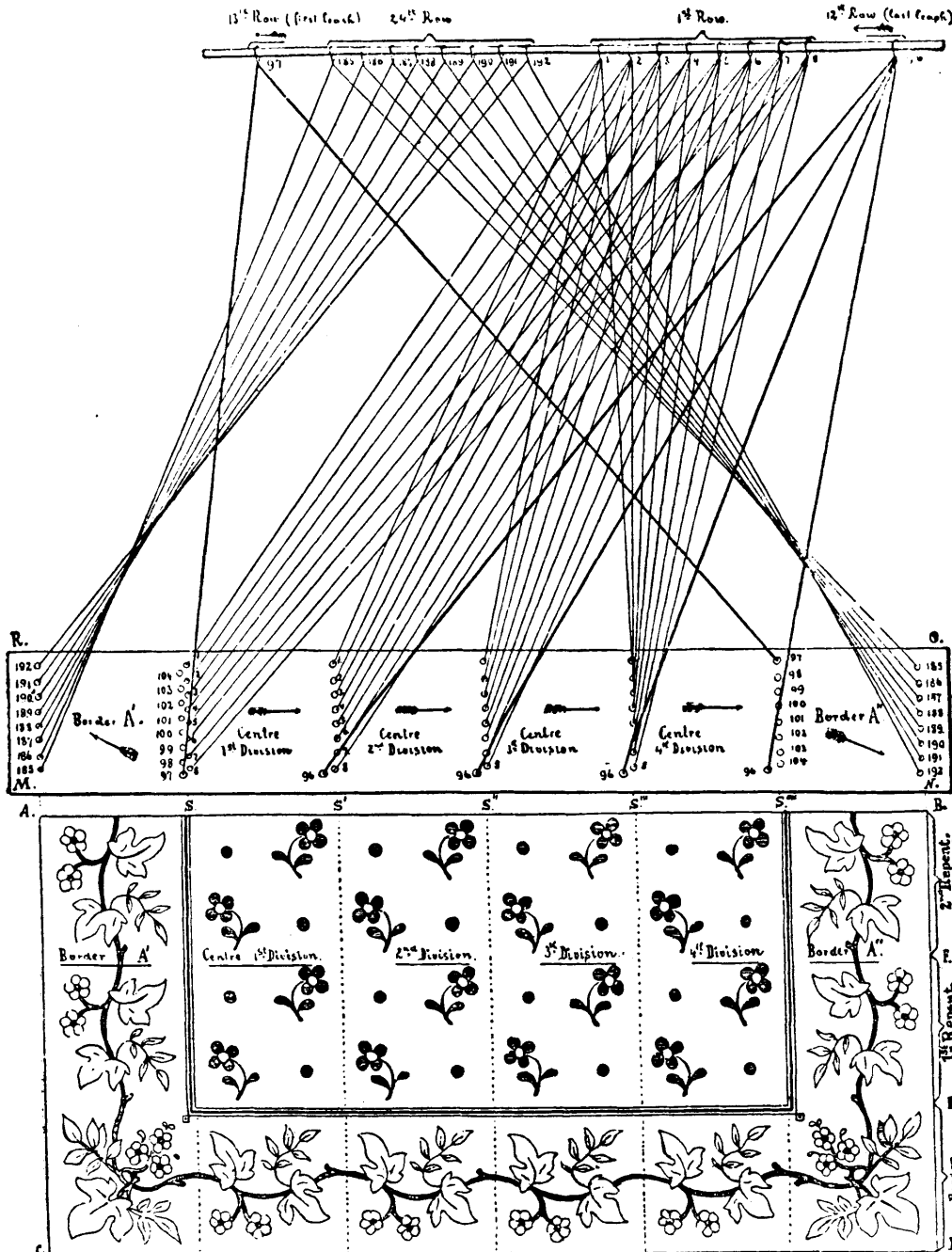

FIG. XXXVIII.

These tie-ups are used to a great extent for napkins, handkerchiefs, scarfs, and similar damask fabrics, in which the centre part of the fabric is worked on the straight-through method ; the borders on each side on the point tie-up, repeating equally from

centre towards the selvedge. In the other two borders to be woven at the beginning and the end of the fabric, the same principle is observed, thus producing four corner squares, only two of which need be designed, as the other two repeat through the arrangement of the tie-up, which must repeat equally towards both sides of the border at the connecting places.

Fig. XXXVIII. illustrates this method of tying-up a 200 machine, using 192 hooks and needles, equal to 24 long rows of a regular 8-row deep machine. The machine is divided into two sections, as follows:

Needles 1 to 96 for the 1st section or centre.

“ 97 “ 192 “ 2d “ “ the border.

4 repeats of centre,  $= 4 \times 96 = 384$  ends.

2 repeats of border, one for each side,  $= 2 \times 96 = 192$  “

576 ends in fabric not including selvedge.

The drawing represents four divisions for the centre, hence four harness-cords for each leash. The border, having only two repeats in the fabric, will contain only two harness-cords to one leash. In the drawing the first full row of the machine is indicated, which is equal to the first row deep of every centre division; containing harness-cords 1, 2, 3, 4, 5, 6, 7, and 8. We also show (heavy line) the last centre leash, No. 96 being the last hook of row 12 of the machine. The borders *A'* and *A''* are from the same design, but the figure runs in an opposite direction in each one, as indicated by the arrows in the comber-board above. Border *A'* commences with harness-cord from leash 192, ending with harness-cord from leash 97, near the centre design. Border *A''* commences with harness-cord from leash 97, near the centre design, ending with harness-

|              |                   |                   |                   |                   |       |                |
|--------------|-------------------|-------------------|-------------------|-------------------|-------|----------------|
| Corner<br>C' |                   |                   |                   |                   |       | Corner<br>C''  |
| A            | S                 | S'                | S''               | S'''              | S'''' | B              |
| C            | 1. <sup>000</sup> | 2. <sup>000</sup> | 3. <sup>000</sup> | 4. <sup>000</sup> |       | D              |
| A            | 1. <sup>00</sup>  | 2. <sup>00</sup>  | 3. <sup>00</sup>  | 4. <sup>00</sup>  |       | B              |
| C            | 1. <sup>0</sup>   | 2. <sup>0</sup>   | 3. <sup>0</sup>   | 4. <sup>0</sup>   |       | F              |
| A            | 1.                | 2.                | 3.                | 4.                |       | B              |
| C            |                   |                   |                   |                   |       | Corner<br>C''' |

cord from leash 192 near the selvedge. The great difficulty to be overcome in arranging these patterns for the loom is in the union of the two tie-ups, the straight-through and the point.

As previously stated, the borders *A'* and *A''* are made with the point tie-up, while the remainder of the borders are made with the straight-through tie-up. The combination of these two tie-ups occurs in the corner squares of the border, and the arrangement must be such as will permit the two sides of the corner patterns to properly unite with the design for the balance of the border.

Ground plan for above fabric: Letters *A, C, D, B, F*, correspond to same letters as used on the outside of fabric design. *S, S', S'', S''', S''''*, also correspond for centre division.

For the purpose of giving a correct comprehension of the foregoing explanation of tying-up, but under a different arrangement, Fig. XXXIX. was designed for a 600 machine, having the same arrangement of the borders, viz.: point tie-up, using

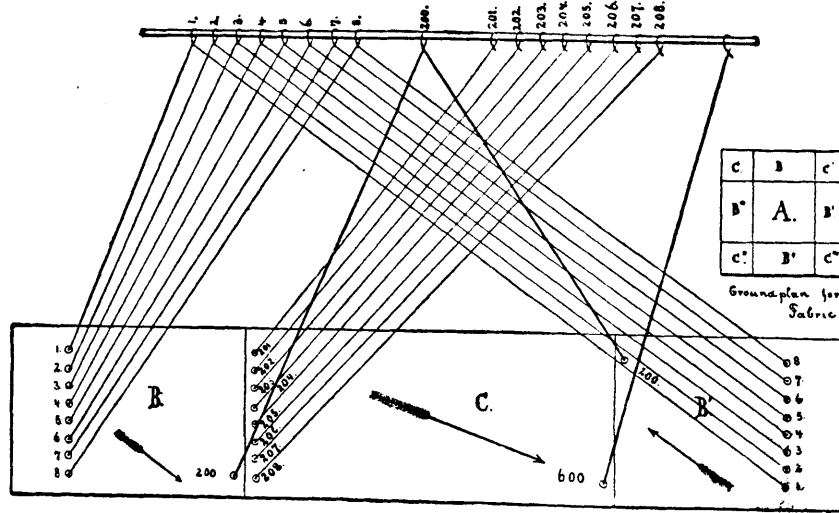

FIG. XXXIX.

one-half division for each side; the centre a straight tie-up, but employing only one repeat. The following particulars will explain the entire procedure:

200 needles and hooks are used for borders, point tie-up, once through, equals  $\frac{1}{2}$  division for each border. [See letters B and B' on comber-board.]

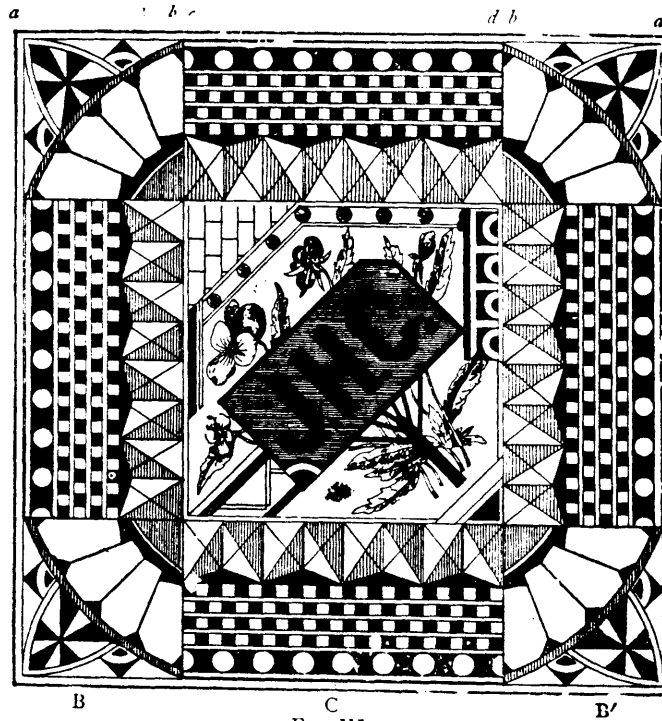
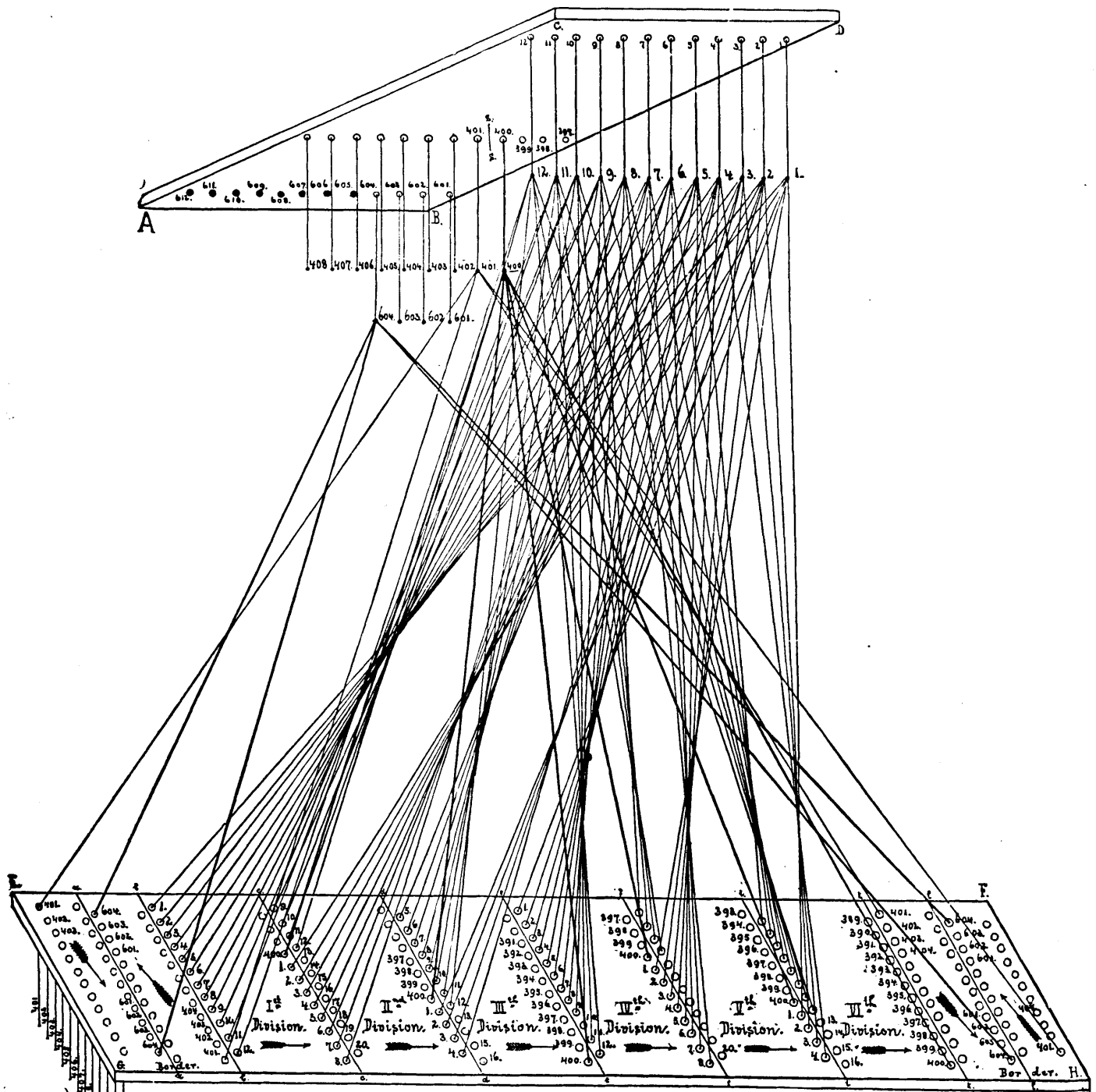

FIG. XL.

400 needles and hooks are used for centre, straight tie-up, one repeat. [See letter C on comber-board.]



**Tie-up for Damask Table covers, 600 Jacquard Machine.**

Centre part of fabric - 6 Divisions - "straight through" Tie-up =  $400 \times 6 = 2400$   
 Border of fabric - "Print" Tie-up - 1 Division for each side =  $200 \times 2 \times 2 = 800$   
 3200 Warp threads.

400 needles for Centre.  
 204 " " Border.  
 8 " " Margins.  
 616 needles Setstage etc.

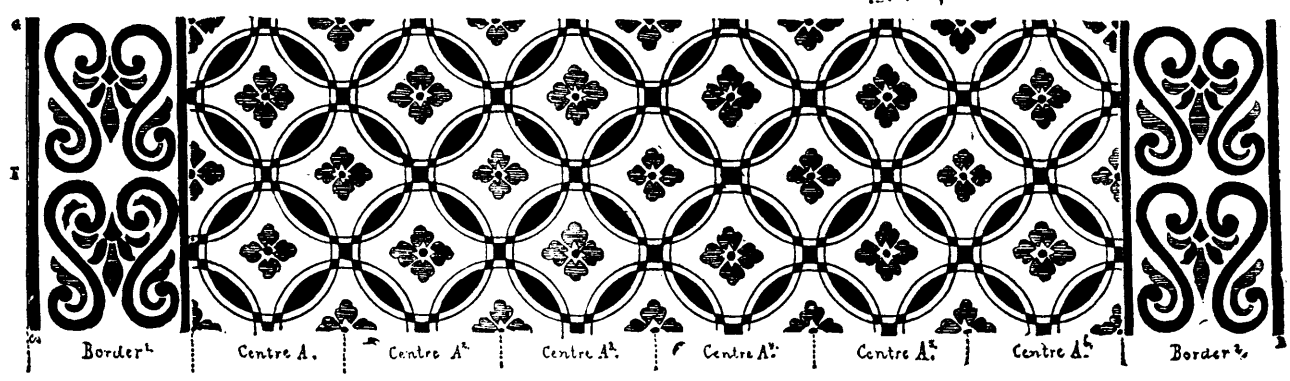

200 ends for each border, = 400 warp-threads.  
 " centre, = 400 "  

---

 800 warp-threads.

In the ground plan of the fabric *A* is the centre; *B, B', B'', B'''*, borders; *C, C', C'', C'''*, corners.

Fig. XL. is a fabric design executed on this principle: *a* to *b*, border; *c* to *d*, centre; *b* to *a*, repeat of the first border.

**Straight-Through and Point Tie ups Combined.**

*B.—For fabrics requiring for their centres a straight-through tie-up, and for their border on point tie-up one full division for each border.*

This arrangement of both foundation tie-ups resembles the preceding. The only difference is found in employing the full division of the centre or point tie-up for each border instead of the half division.

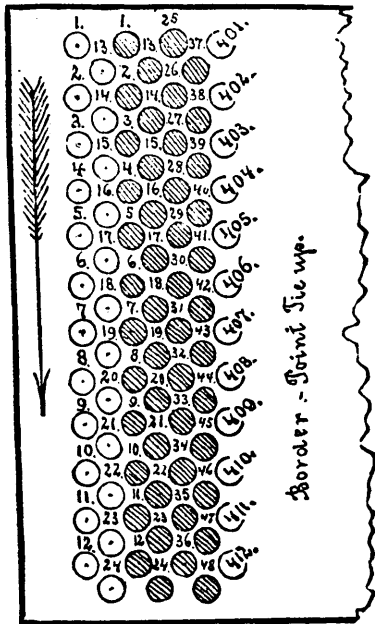

○ Selvage.  
 ● Margin.  
 ○<sub>1st</sub> 1st row of Border.

FIG. XLII.

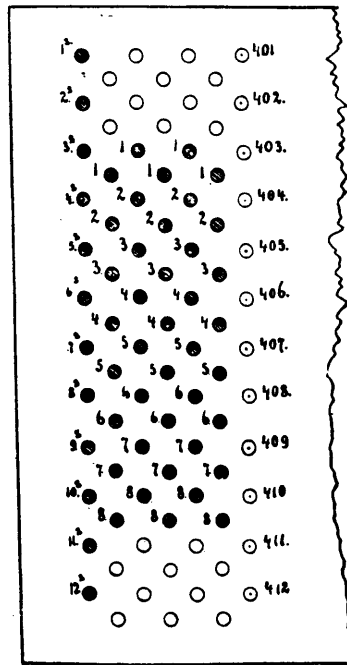

FIG. XLIII.

Fig. XLI. illustrates this method of tying-up adjusted to a 600 Jacquard machine. The centre of the fabric requires 400 needles and hooks in 6 repeats or divisions, or  $400 \times 6 = 2400$  warp-threads. The border calls for 204 needles and hooks, point tie-up, one full division for each side, or  $204 \times 2 \times 2 = 816$  warp-threads. The arrangement of margin and selvage, as applied on each side, is explained

separately through ground plan of comber-board by fig. XLII. The margin calls for 8 needles and 8 hooks in machine, 6 repeats of same for each side, or 96 warp-threads. The selvedge is formed by 2, 4 or 8 needles, (working plain), and has 24 heddles for each side or 48 selvedge-threads in warp. These selvedge ends may, if preferred, be drawn two ends in one heddle. By adding these different systems of threads we find :

|          |   |       |                                     |
|----------|---|-------|-------------------------------------|
| Centre   | = | 2400  | warp-threads.                       |
| Borders  | = | 816   | " " (814 if point drawn only once.) |
| Margin   | = | 96    | " "                                 |
| Selvedge | = | 48    | " "                                 |
|          |   | <hr/> |                                     |
|          |   | 3360  | threads in warp.                    |

For the centre part of the fabric, needle and hook 1 to 400 are used.

|          |   |   |   |   |     |   |     |   |
|----------|---|---|---|---|-----|---|-----|---|
| " border | " | " | " | " | 401 | " | 604 | " |
| " margin | " | " | " | " | 605 | " | 612 | " |

Leaving one complete row of the reserve to use for selvedge, etc., if required.

In drawing, Fig. XLI., we only illustrate centre and border of the tie-up, so as not to confuse the eye by too many lines, and, as mentioned at the beginning, employed Fig. XLII. for illustrating the ground plan for selvedge and margin. In selvedge and margin the harness-cords are indicated by consecutive numbers, thus :

Margin, 1 to 48.

Selvedge, 1 " 24.

When threading margin in comber-board :

|    |     |     |     |     |     |                          |
|----|-----|-----|-----|-----|-----|--------------------------|
| 1, | 9,  | 17, | 25, | 33, | 41, | call for the same leash. |
| 2, | 10, | 18, | 26, | 34, | 42, | " " "                    |
| 3, | 11, | 19, | 27, | 35, | 43, | " " "                    |
| 4, | 12, | 20, | 28, | 36, | 44, | " " "                    |
| 5, | 13, | 21, | 29, | 37, | 45, | " " "                    |
| 6, | 14, | 22, | 30, | 38, | 46, | " " "                    |
| 7, | 15, | 23, | 31, | 39, | 47, | " " "                    |
| 8, | 16, | 24, | 32, | 40, | 48, | " " "                    |

Leashes in centre part of fabric, 1 to 400 call for 6 harness-cords.

|                                  |   |     |   |     |   |    |   |   |
|----------------------------------|---|-----|---|-----|---|----|---|---|
| " border                         | " | 401 | " | 604 | " | 4  | " | " |
| " margin                         | " | 605 | " | 612 | " | 12 | " | " |
| " for selvedge if using 4 hooks, |   | 613 | " | 616 | " | 12 | " | " |

This tie-up is the one most frequently employed in the manufacture of damask table-covers. Not only will drawings and explanations lead to a thorough understanding of the procedure, but they will also readily show the great variety of textile fabrics to which the principle of this tie-up may be applied.

Fig. XLIII. illustrates the margin arranged 8 threads for each row, and 5 rows or 40 threads for each side. The selvedge in this drawing is illustrated by one complete row of 12 double threads for each side. The selvedge and margin holes are all represented shaded. The selvedge is marked S in addition to the number. The five margin rows are indicated each by figures 1 to 8. The

nearest row of border is also represented, being numbered 401 to 412, corresponding to Fig. XLI. This method of using only 8 rows of the 12-row deep comber-board is extensively used in fabrics of a common texture, employing an 8 harness satin for the margin as weave, which repeats once for each row in comber-board. Besides, a great advantage results from being able to tie-up 8 leashes threaded 8 rows deep in comber-board to the 8 hooks in 1 row of the machine, which the weave calls for.

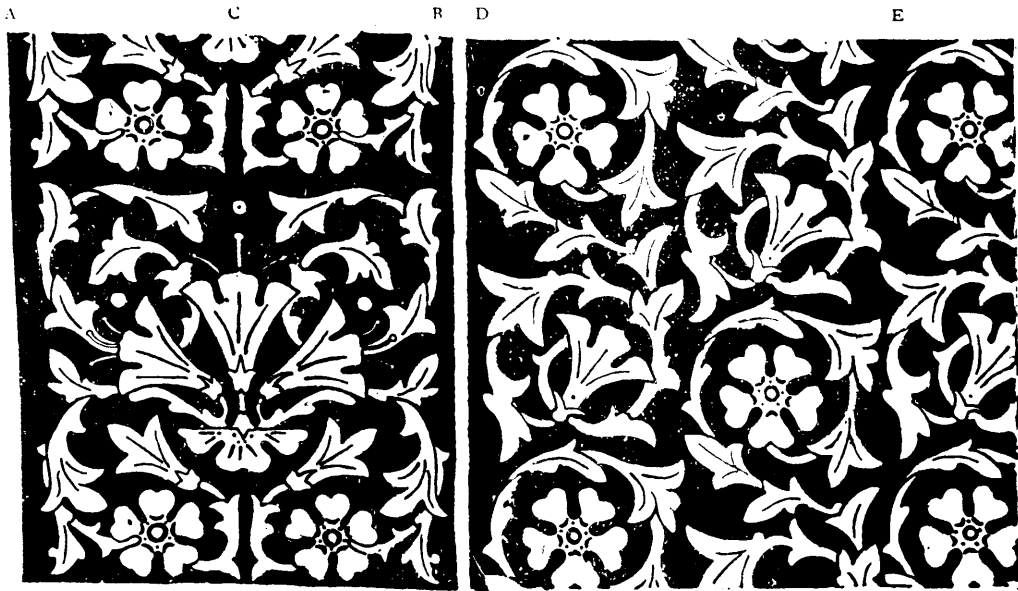

FIG. XLIV.

Fig. XLIV. and Fig. XLV. represent designs for fabrics executed on this method of tying-up.

Fig. XLIV.—*A* to *B* = border, *C* the centre.

*B* " *D* = margin, between centre and border.

*D* " *E* = 1 repeat of the centre, 6 times over in width of fabric.

Fig. XLV.—*A* to *B* = border, *C* its centre.

*B* " *D* = centre, 6 times over in width of fabric.



FIG. XLV.



Straight-Through and Point Tie-ups Combined.

*C.—For fabrics having the centre for straight-through, with the border for straight-through, and point tie-ups, (half divisions), combined.*

This method of tying-up is illustrated in Fig. XLVI., and the fabric produced in Fig. XLVII. With this method of tying-up is usually introduced an extra margin for the purpose of separating the ornamentation of the design, so as to permit of a clearer definition. This is tied-up on 8 needles and hooks, situated between border and centre, (24 ends) shown at margin *B* in the design. The centre of the fabric, (two



FIG. XLVIII.

divisions only illustrated out of ten actually used), is tied-up on the straight-through method, requiring for its working, harness-cords 1 to 240. The border has the point tie-up in half-sections; these half sections have a straight-through tie-up design in its centre. Harness-cords 241 to 456 are used for the straight-through section, and 457 to 600 for the point tie-up section. The margin is produced by harness-cords 601 to 608, leaving 16 needles and hooks of the machine unemployable, which may be used for selvedge or other purposes. The drawing of this tie-up and fabric illustrates only the right-hand side. The complete design requires, in addition to the borders and margins, 10 divisions or repeats in the centre. The figure shows only two of these repeats and border and margins of one side. The number of ends in the fabric is found as follows:

|  |                    |
|--|--------------------|
| Centre, 10 × 240   | = 2400 ends.       |
| Border, { point, 4 × 144 = 576 }<br>{ straight, 2 × 216 = 432 }                                    | = 1008 “           |
| Margin, { between border and centre, 24 × 2 = 48 }<br>{ between border and selvedge, 48 × 2 = 96 } | = 144 “            |
| Selvedge, not indicated in drawing of tie-up,  | = 48 “             |
|  | 3620 ends in warp. |

Centre A. - A'

Border II

Border C.

Margin B

FIG. XLVI.

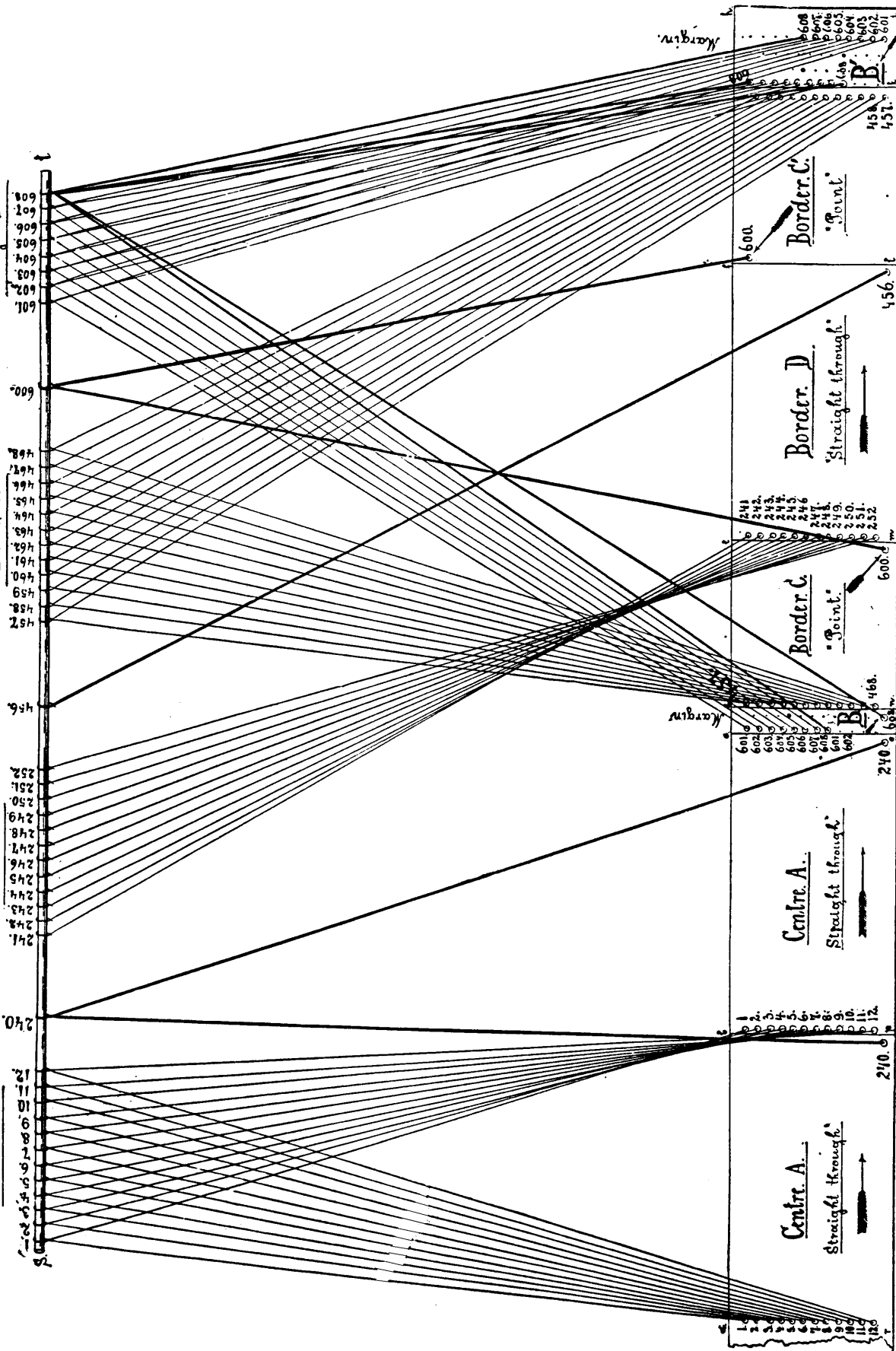

Number of harness-cords required for each leash:

|         |           |                        |   |     |
|---------|-----------|------------------------|---|-----|
| Leashes | 1 to 240  | = 10 cords to 1 leash. |   |     |
| "       | 241 " 456 | = 2                    | " | 1 " |
| "       | 457 " 600 | = 4                    | " | 1 " |
| "       | 601 " 608 | = 18                   | " | 1 " |

Selvage leashes, if worked by 4 needles and hooks, = 12 cords to 1 leash.

Fig. XLVIII., on page 42, illustrates another fabric design to be executed on this method of tie-up.

$\mathcal{A}$  to  $\mathcal{D}$  = Border {  $\mathcal{A}$  to  $\mathcal{B}$  = point tie-up with  $\mathcal{C}$  to  $\mathcal{D}$ .  
 $\mathcal{B}$  to  $\mathcal{C}$  = straight-through part.  
 $\mathcal{D}$  to  $\mathcal{E}$  = Centre, first repeat, division, for straight-through.

**Straight-Through and Point Tie-ups Combined.**

*D.*—For fabrics composed of the straight-through tie-up for centre; the point tie-up, half divisions, and the point tie-up, full divisions, for borders.

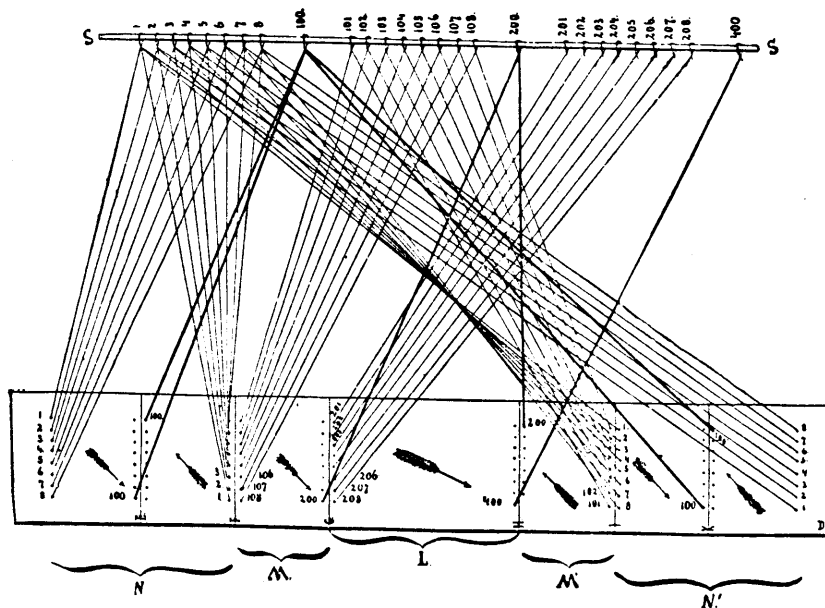

FIG. XLIX.

This method of tie-up is used to a great extent in the manufacture of damask napkins, containing in its centre the monogram of hotels, restaurants, or private names. This effect is produced by floating the filling.

In this manner, we find tie-up, Fig. XLIX., and fabric sample, Fig. L., executed, using for explanation a 400 Jacquard machine, certainly very low texture for these fabrics. In case of a higher texture being necessary, each effect must be proportionally increased. The machines most generally used for this class of fabrics are of the 900-1200 denomination.

Taking the present tie-up into consideration, we find the centre for forming the monogram, containing 200 harness-cords tied-up straight-through the borders on

each side of the monogram, is executed on the point tie-up, one-half section for each side, taking 100 needles and hooks, or harness-cords. The outside border on each side is executed on the point tie-up, using one complete division of it for each side; and in addition, 100 harness-cords for the working. Adding these various divisions of the harness-cords gives the number of warp-threads as follows, viz.:

|   |                  |  |                                     |
|---|------------------|--|-------------------------------------|
| Border, <i>N</i> , 100 needles on point | = 200 threads,   | (199 if omitting the point the second time). |                                     |
| “ <i>M</i> , 100 needles on straight    | = 100            | “  |                                     |
| Centre, <i>L</i> , 200 “                | “ straight = 200 | “  |                                     |
| Border, <i>M'</i> , 100 “               | “ return = 100   | “  |                                     |
| “ <i>N'</i> , 100 “                     | “ point = 200    | “  | (199 if omitting the double point.) |
| —                                       |                  |  |                                     |
| 800 threads.                            |                  |  |                                     |

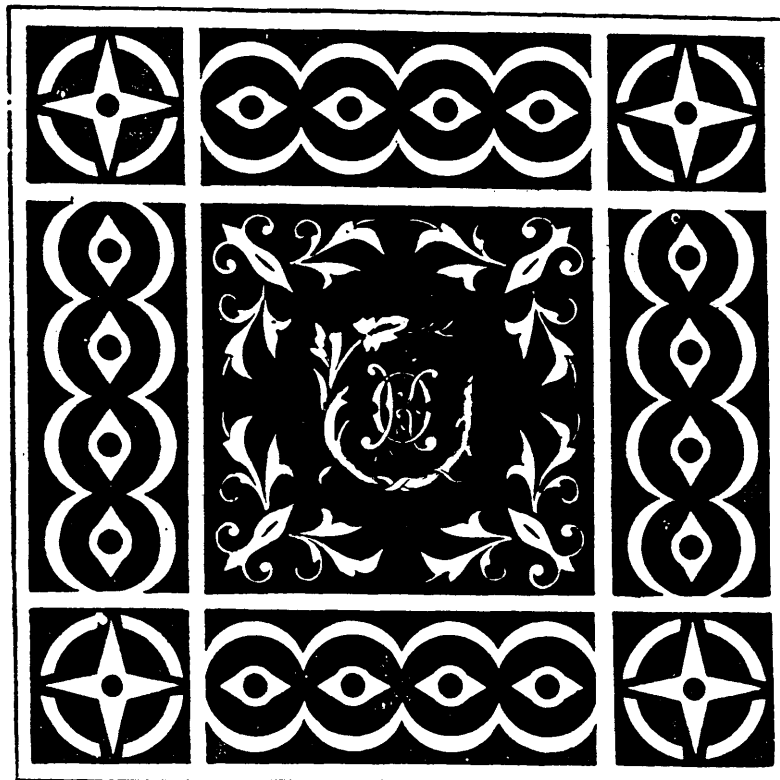

FIG. L.

For number of harness cords to each leash we find:

|                    |             |                          |   |   |   |
|--------------------|-------------|--------------------------|---|---|---|
| Needles and hooks, | 1 to 100    | = 4 cords to each leash. |   |   |   |
| “                  | “ 101 “ 200 | = 2                      | “ | “ | “ |
| “                  | “ 201 “ 400 | = 1 cord                 | “ | “ | “ |

Fig. LI. illustrates a fabric, damask table-cover, to be executed on the same principle



Margin =  $a$  to  $b$  and  $h$  to  $i$ .

Border  $\left\{ \begin{array}{l} \text{small} = \left\{ \begin{array}{l} b \text{ to } c \text{ and return } c \text{ to } d \\ f \text{ " } g \text{ " " } g \text{ " } h \end{array} \right\} \text{ Point.} \\ \text{main} = \left\{ \begin{array}{l} d \text{ " } e \text{ " " } e \text{ " } f \end{array} \right\} \text{ " } \end{array} \right.$

Centre = 1st division  $i$  to  $k$ , straight-through.

This fabric can also be executed on the tie-up explained through Fig. XLI., as follows:

Border =  $a$  to  $i$  on point tie-up,  $e$  for centre or point.

Centre = 1st division  $i$  to  $k$ , straight-through.

### Straight-Through and Point Tie-ups Combined.

#### *E.—Mixed Tie-up.*

Containing in one repeat of the design the straight-through tie-up and the point tie-up, one full division, for the centre; the point tie-up, in half divisions, repeating once through on each side of the fabric, to make the border. These arrangements of tie-ups are used to a great extent in the manufacture of damask fabrics of every denomination.

The principle of using mixed tie-ups, Fig. LII., is found in the necessity of producing large designs, containing varied effects, with a proportionally smaller Jacquard machine. Under whatever management the straight-through and the point tie-ups are combined, their principle remains undisturbed. Every time we arrange a Jacquard loom on a mixed tie-up, we must consider that any subsequent design must be arranged with reference to the same principle as the one in use, otherwise the work must all be rearranged, which would have to be done even for the smallest change in the number of ends for each effect.

Take for illustration a damask fabric, Fig. LIII., handkerchief, bureau scarf, an square, etc. The details given will make the work quite plain:

Part of comber-board from  $A$  to  $B$ , or  $D$  to  $C$ , illustrates one-half of the board and procedure of tying-up. The design below also shows only one-half of the fabric. Arrow,  $G$ , near comber-board, and arrow,  $M$ , near fabric, are placed to indicate the direction in which a repeat is obtained. The fabric will form its centre at  $D$ , repeating towards each border and selvedge. This is illustrated in the comber-board by the 1-row deep, outside of line  $A, D$ . Harness-cords indicated by dotted lines. The threading of this last mentioned row, as well as the threading of the half division of the point tie-up, is indicated by arrows  $H$  and  $K$ , forming the centre by means of harness-cords 193 and 193. The straight-through tie-up part of the fabric is found between  $E$  and  $F$ , containing 12 repeats in the centre, and also the same number in the lower border. In the comber-board is illustrated this arrangement, repeating the first row, containing harness-cords 1, 2, 3, 4, 5, 6, 7, 8, twelve times, and the last hole of the third row containing harness-cord No. 24, twelve times. On the bottom of the comber-board these 12 repeats are indicated by 12 small arrows between parts  $E$  to  $F$ .

The first row in the first division of the straight-through tie-up is completely

FIG. LII.

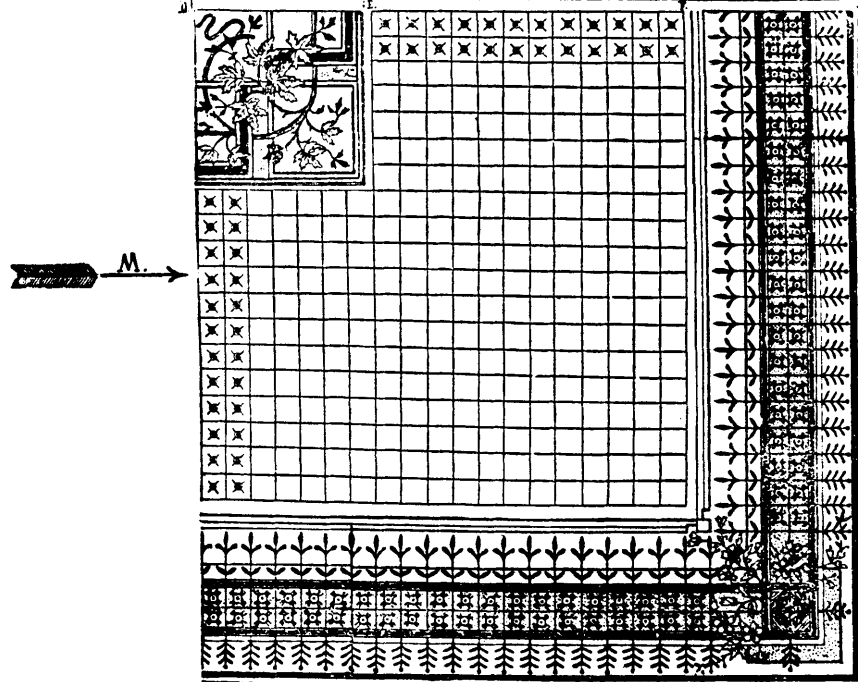
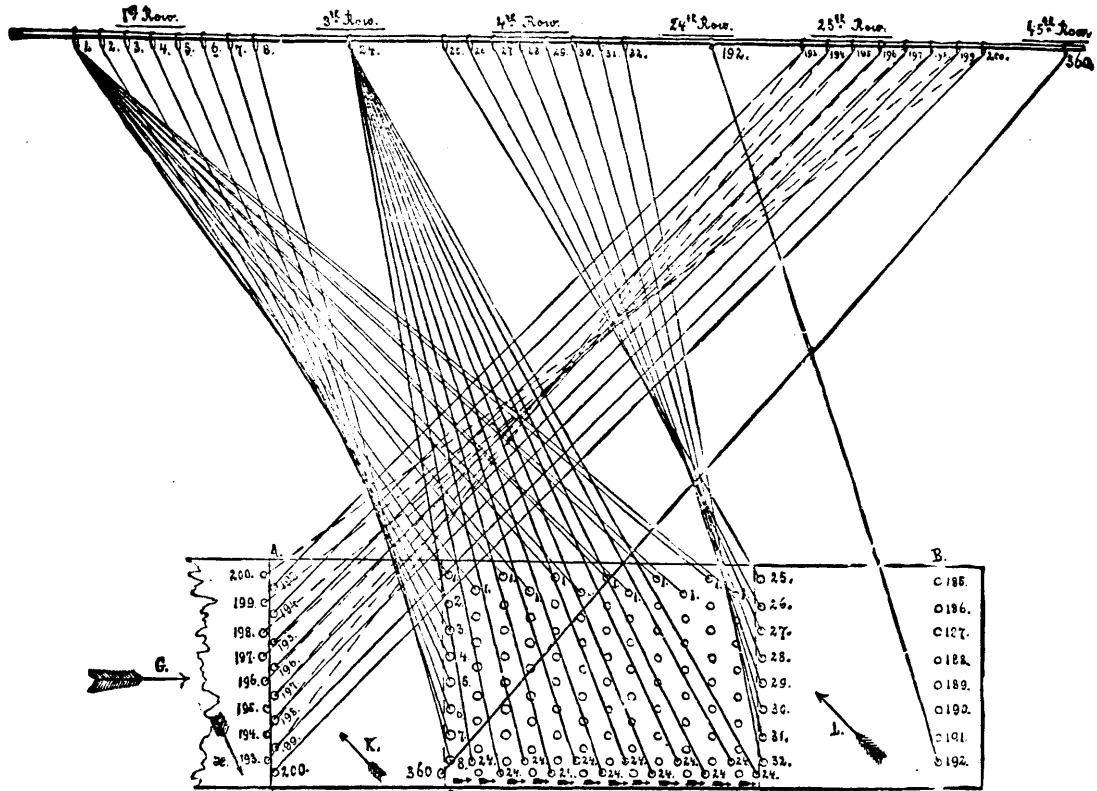

FIG. LIII.

threaded; the other eleven have only the harness-cord from leash 1, as indicated; this is done so as not to confuse the eye with too many lines. The border of the fabric is arranged for harness-cords 25 to 192 on the point tie-up, having one-half division

on each side. Arrow *L* indicates the right-hand border. The border on the left requires the same harness-cords which are threaded in comber-board from right to left; hence the borders of the fabric contain the same design repeating from the centre towards the selvedge.

At the beginning we stated that the use of mixed tie-ups made it possible to employ a smaller size Jacquard machine for large designs containing various effects. The following analysis of Fig. LII. shows very clearly how this is done.

Number of warp-ends in one complete repeat in width of the fabric:

|                       |   |       |                      |
|-----------------------|---|-------|----------------------|
| Border, right-hand,   | = | 168   | threads.             |
| Centre, straight-tie, | = | 288   | "                    |
| " point-tie,          | { | = 168 | "                    |
|                       | { | = 168 | "                    |
| " straight-tie,       | = | 288   | "                    |
| Border, left-hand,    | = | 168   | "                    |
|                       |   | 1248  | ends warp in fabric. |

Number of needles required to produce the design:

Border, = 168 needles.

Centre on straight-tie, = 24 needles.

Centre on point-tie, = 168 needles.

360 needles required for producing the complete design, thus saving the difference between 1248 and 360, or 888 needles; all of which is accomplished through the use of the mixed tie-up.

Number of harness-cords required for each leash:

Leashes 1 to 24 contain 24 cords for one repeat of the entire design. Leashes 25 to 360 contain 2 cords for one repeat of the entire design. It is not always practicable to reduce the effects in a design to the lowest possible number of needles. On account of the changes in styles, it is best to arrange these tie-ups with a view to giving as much opportunity as possible to the designer. In the present tie-up experience teaches that it will be more advantageous to arrange the straight-through tie-up either for 6 divisions to 48 ends each, or 4 divisions to 72 ends each. 360 needles, as figured at the beginning, require a 400 machine, or, counting reserve rows, 416 needles; hence we can, without disadvantage, increase 360 needles to 384 or 408, which will give a greater scope, if required, to make a new design.

## VI. The Straight-Through Tie-up in Two Sections.

### *A.—Using machine and comber-board in two equal sections.*

This tie-up, Fig. LIV., is used on fabrics having two different kinds of warp, which, as a rule, are of different colors. One of these warps is shown working at *B* in the comber-board, and also at the bottom-board. The other warp employed for the figure effect is shown working at *A*. Fabrics that are made on this tie-up can also be made on the common straight-through; but the work of designing and card stamping will be largely increased. In the illustration all the figure-



threads, and also all the threads used for the weave (binder-threads) can be designed without interruption to each other. The breaking off of the figures is thus avoided, a thing quite impossible where the regular straight-through tie-up is used. The drawing given herewith represents this straight-through tie-up in sections applied to a 200 Jacquard machine. The reserve rows are omitted. The machine and the comber-board, it will be observed, are divided into two even parts. In one part, the rear of *A*, of the comber-board we thread only in the leashes from needles 1 to 100, and in the other part, front of *B*, from needles 101 to 200. Hence, the first row of the comber-board contains leashes 1 to 4 and 101 to 104; the second row will contain leashes 5 to 8 and 105 to 108; the third row will contain leashes 9 to 12 and 109 to 112, and so on, each division finish-

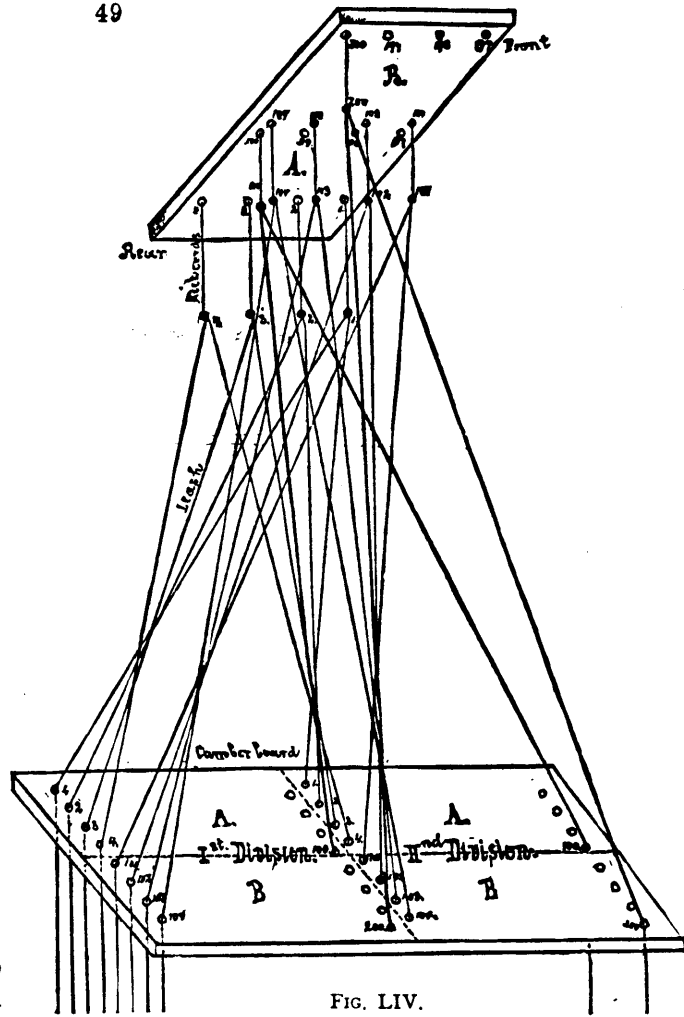

FIG. LIV.



FIG. LV.

ing on the last row (25th) with leashes 97 to 100 and 197 to 200.

The leasing of the threads is always done by alternately threading the harness-cords of section *A* with section *B*. Hence, first thread of the warp draws in first mail of leash No. 1; second thread of the warp draws in first mail of leash No. 101; third thread of the warp draws in first mail of leash No. 2; fourth thread of the warp draws in first mail of leash No. 102.

Fig. LV., a fabric design for cloaking for straight-through tie-up in two sections. *A*, face warp, black silk; *B*, back warp, black cotton.

*B. Using two machines and a comber-board having equal sections.*

Sometimes two or more machines are employed in producing fabrics having two systems of warps; each machine working on its own system. In this manner Fig. LVI. is executed, representing a straight-through tie-up arranged for two Jacquard machines, *S* and *H*, in which the warp is drawn in the Jacquard harness as follows: one end from machine *S*, one end from machine *H*. For explanation two 100 Jacquard machines are used for the purpose of simplifying the arrangements of laying out and threading the comber-board. A larger Jacquard machine for the illustrations would require more leashes, and the explanation would be more difficult.

The comber-board, *a, b, c, d*, is divided into two equal parts, *S* and *H*. Each part containing the harness-cord for one machine only. The drawing of the tie-up is arranged for two divisions, and also readily explains any tie-up for more divisions.

The leasing of the Jacquard harness, *K*, is arranged (as illustrated in the drawing by leash-rods *p* and *r*) to commence as follows:

The leasing of the Jacquard harness, *K*, is arranged (as illustrated in the drawing by leash-rods *p* and *r*) to commence as follows:

1st end: harness-cord fastened to No. 1 needle of machine, *S*; 2d end to No. 1° needle of machine, *H*; 3d end to No. 2 needle of machine, *S*; 4th end to No. 2° needle of machine, *H*; 5th end to No. 3 needle of machine, *S*; 6th end to No. 3° needle of machine, *H*; 7th end to No. 4 needle of machine, *S*; 8th end to No. 4° needle of machine, *H*.

These eight ends, forming the first complete row of the comber-board, will use the first row of both machines; the second row of the comber-board will use the second row of both machines; and so on, until every row of the comber-board, with corresponding row of the Jacquard machine, is taken up. In the drawing we

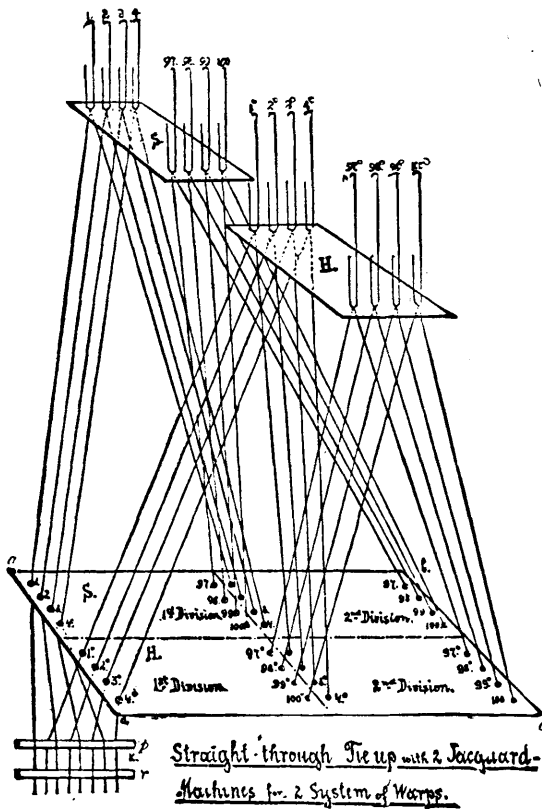

FIG. LVI.

have indicated, as usual, besides the first row, the last row of the machine and the comber-board; or, in other words, we show the threading of

|               |                                 |                   |            |
|---------------|---------------------------------|-------------------|------------|
| Warp end 193: | harness-cord fastened to No. 97 | needle of harness | <i>S</i> . |
| " 194:        | " " " 97°                       | " "               | <i>H</i> . |
| " 195:        | " " " 98                        | " "               | <i>S</i> . |
| " 196:        | " " " 98°                       | " "               | <i>H</i> . |
| " 197:        | " " " 99                        | " "               | <i>S</i> . |
| " 198:        | " " " 99°                       | " "               | <i>H</i> . |
| " 199:        | " " " 100                       | " "               | <i>S</i> . |
| " 200:        | " " " 100°                      | " "               | <i>H</i> . |

This method of using two Jacquard machines, on the principle explained, is employed on Jacquard looms for dressgoods figured with an extra warp, on upholstery goods, and similar textile fabrics.

Fig. LVII. shows a fabric design for a curtain, to be executed on the straight-through tie-up in two sections.

*C.—Using one machine and one comber-board: the machine unequally divided and the comber-board equally divided.*

To explain, take the regular upholstery fabric tie-up known as "petty point," on a 600 machine 12 rows in depth.  $600 \div 12 = 50 + 2$  rows reserve = 52 rows in width. We find used—

1 row for selvedge.

10 rows for binders (B).

41 rows for figure (A).

52 rows.

41 (rows figure)  $\times$  12 (needles for one row) = 492 needles to be used for figure.

10 (rows binder)  $\times$  12 (needles for one row) = 120 needles to be used for binder.

Suppose we have four divisions in loom, hence, four harness-cords to one leash, for the figure section, or  $492 \times 4 = 1968$  ends of warp used for figure. 1968 threads of figure warp require the same number of threads of ground warp, which must be divided by 120, the number of needles and hooks set apart for it in the machine, or—as each needle and hook carries one leash—120 leashes.  $1968 \div 120 = 16$  repeats; and 48 leashes, or four rows in the machine, must each have 17 harness-cords carrying 816 threads; and 72 leashes, or six rows in the machine, must each have 16 harness-cords carrying 1152 threads, = 1968.

**VII. Tying-up a Jacquard Harness for Figuring Part of the Design with an Extra Warp, (part for Two Sections, part for Single).**

This tie-up (the character of which is indicated in Fig. LVIII.) is used for textile fabrics having two distinct warps in part of the fabric, and a single warp in the

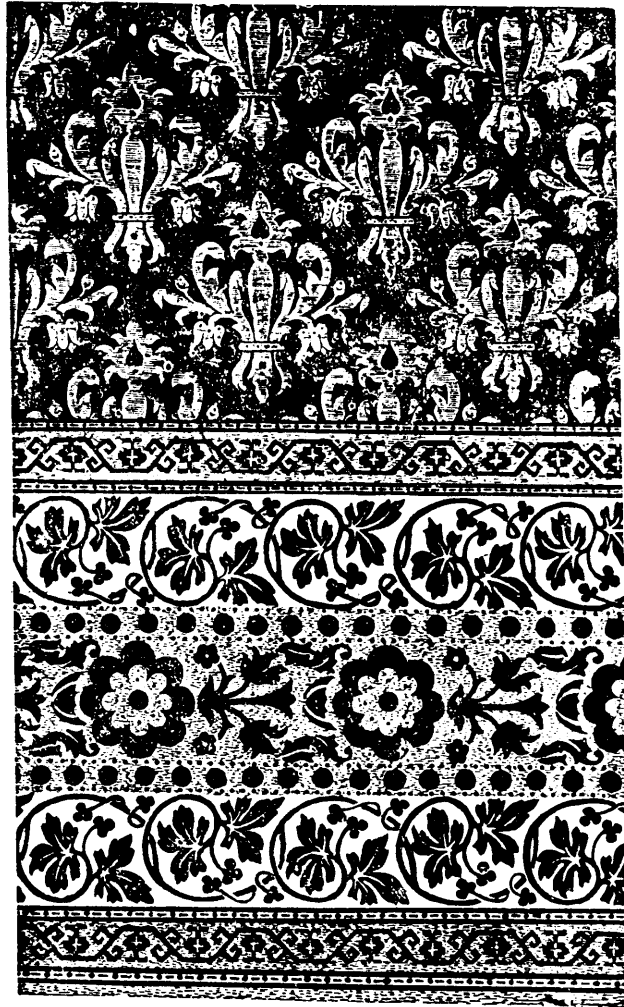

FIG. LVII.

remainder, for ground only. It will readily be seen in the drawing which explains this tie-up that one part of the fabric will have to contain more ends of warp per inch than the other, as the figuring is done with an extra warp upon the regular ground cloth. The number of ends of ground warp per inch will, as a general rule, be the same

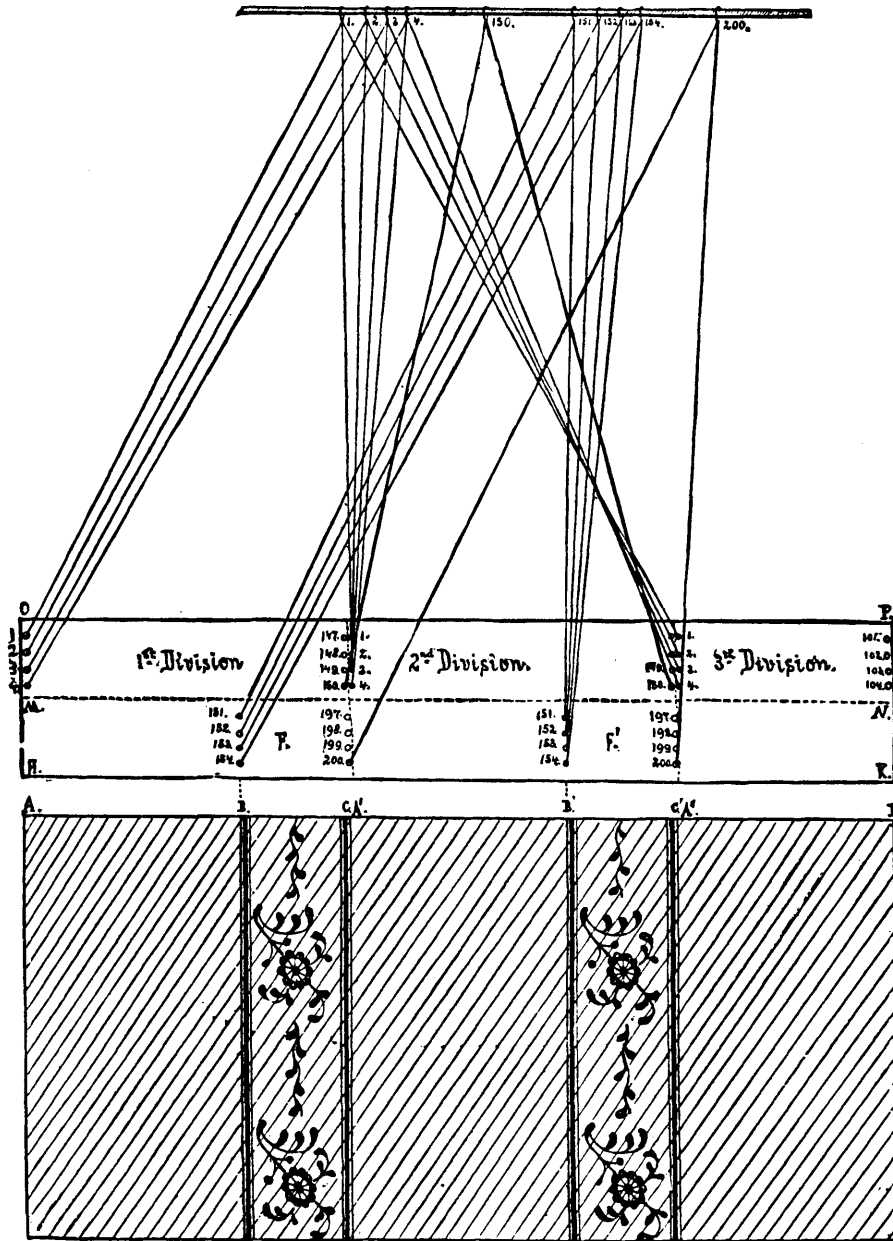

FIG. LVIII.

throughout the fabric. In Fig. LVIII., explaining this method of tying-up, the texture is twice as high in the figure stripe as in the ground part of the fabric. If 40 ends of warp per inch are used for the ground, 80 ends per inch must be used in the figured part, B to C, B' to C').

A 200 machine is used in the illustration, divided as follows :

150 needles for the ground over the entire fabric, *A* to *B''*.

50 needles for the figure effects, *B* to *C*, and *B'* to *C'*.

The comber-board, therefore, must be arranged accordingly, ( $2\frac{2}{3}$  divisions in drawing executed). The depth of the comber-board is divided into two parts: *H, M, N, K*, the first; *M, N, O, P*, the second. The first contains leashes fastened to neck-cords attached to needles 151 to 200, or the figure part, *F* and *F'*; the second contains leashes fastened to neck-cords attached to the needles 1 to 150, or the ground part for the entire fabric. In the drawing of lines showing the harness-cords of the Jacquard harness we have only indicated :

*A.* The ground part, leashes Nos. 1, 2, 3 and 4 in rotation, and No. 150. This last leash of the ground warp we have indicated by a heavy line.

*B.* For the figure part, needles 151 to 200 are used. Leashes 151, 152, 153, 154, are indicated in rotation, also the leash operated by hook 200; this latter one being also lined more distinctly than the others.

These explanations readily show how to adapt the tying-up for any textile fabric made upon this principle to any number Jacquard machine.

#### VIII. The Straight-Through Tie-up in Three Sections.

The straight-through tie-up in three sections, which is illustrated by drawings, Figs. LIX. and LX., is largely used in the manufacture of fancy plushes and velvets, and also in the construction of any other kinds of fabrics in which the face is figured in three systems of warps, or in two systems of warps for the face and one system for the binder.

If it were required, these fabrics could be made on the straight tie-up, (Figs. XXV., XXVIII. and XXX.), but, as will readily be seen, they may be worked to much better advantage, both for designing and card-stamping, upon the method shown here.

Fig. LIX. illustrates the method of adjusting the leashes to the neck-cords and threading the comber-board. In the example, we use for describing the method a 900 Jacquard machine, and follow the English system for placing it on the loom. The machine is divided into three sections: Section 1, using hooks and needles 1 to 300; Section 2, using hooks and needles 301 to 600; Section 3, using hooks and needles 601 to 900, leaving the two reserve rows (generally found in every machine) out of the illustration.

The comber-board is divided into two divisions lengthways, (but the same method must be observed if more than two divisions are used), and also into three sections in its depth. The number of sections in the comber-board must correspond to the number of sections in the machine.

The threading of the machine is done from the rear towards the front, and from the left towards the right. The threading of the comber-board is done in a corresponding manner. 300 ends for each section in one division, divided by 4 rows deep each section, making 75 cross-rows. Threading of the Jacquard harness is as follows :

- No. 1 from Section 1, white.
- 301 " " 2, shaded.
- 601 " " 3, black.
- 2 " " 1, white.
- 302 " " 2, shaded.
- 602 " " 3, black.
- 3 " " 1, white.
- 303 " " 2, shaded.
- 603 " " 3, black.
- 4 " " 1, white.
- 304 " " 2, shaded.
- 604 " " 3, black.
- 5 " " 1, white.
- 305 " " 2, shaded.
- 605 " " 3, black.

And so on; all of which are shown separately in Fig. LX.

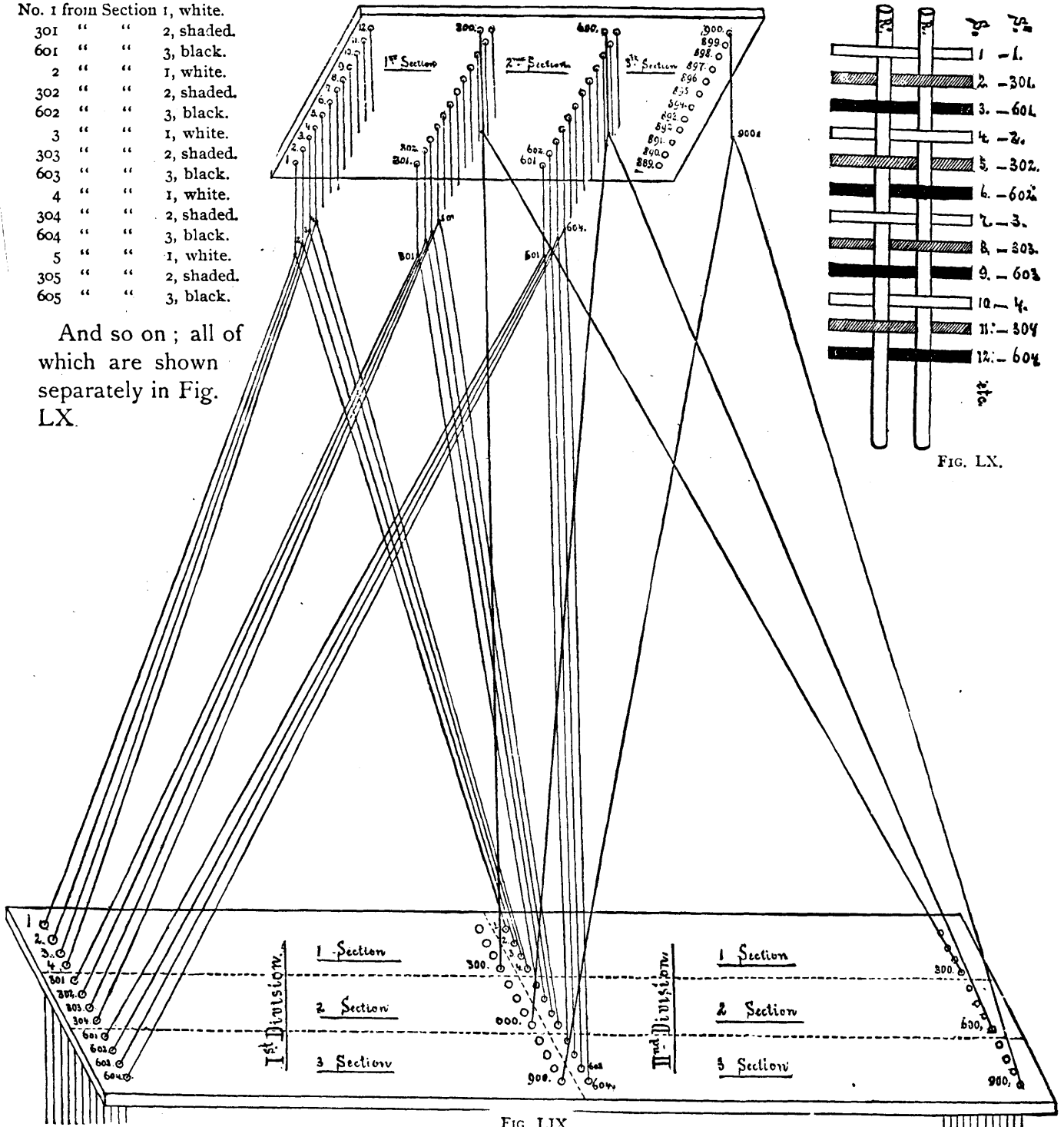

FIG. LIX.

*R* and *R''* are for the two-lease strings; *S*, the successive order of threads; *S'*, the number of leases. Hooks and needles correspond with drawing *A*. White warp-threads indicate section 1; shaded warp-threads, section 2; black warp-threads, section 3. The fine lines in Fig. LIX. indicate the leases for the first

row deep of the comber-board; the heavy lines indicate the last leash for each section.

Fig. LXI. illustrates a fabric designed for this tie-up. The various small star effects are arranged on the principle of the 5-leaf satin.

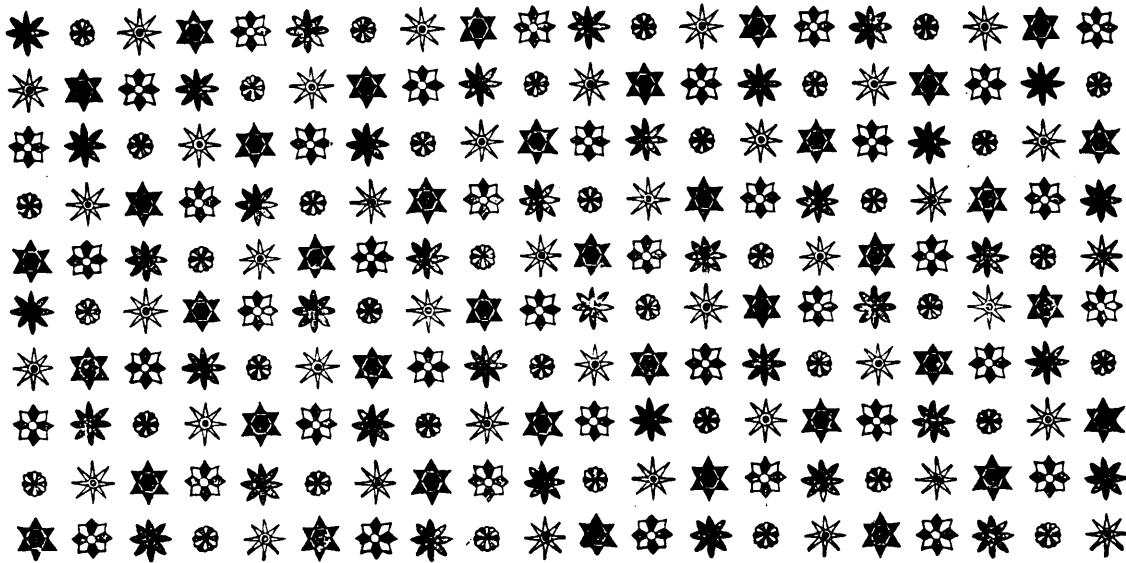

FIG. LXI.

IX. The Point Tie-up in Three Sections.

This method of tying-up Jacquard looms shows the point tie-up applied to the three-section arrangement, on the same principle as the straight-through in paragraph VIII.

Fig. LXII. shows the comber-board divided into three distinct sections, marked

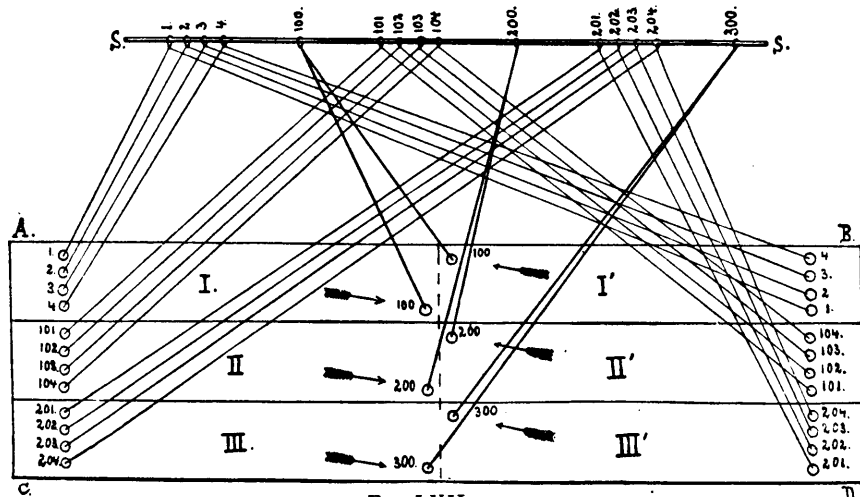

FIG. LXII.

*I.*, *II.* and *III.* For explanation, take a 300 machine; allow 100 needles and hooks for each section, distributed as follows: Section *I.*, 1 to 100; Section *II.*, 101 to 200; Section *III.*, 201 to 300. Each section contains 200 warp-threads; and the complete

division of three sections, 600 threads. The threading of three sections, illustrated in Fig. LX., is applied to the present tie-up, as follows:

|                       |     |                 |   |               |   |
|-----------------------|-----|-----------------|---|---------------|---|
| 1st end, from section | I., | attached to No. | 1 | harness-cord. |   |
| 2d                    | “   | II.,            | “ | 101           | “ |
| 3d                    | “   | III.,           | “ | 201           | “ |
| 4th                   | “   | I.,             | “ | 2             | “ |
| 5th                   | “   | II.,            | “ | 102           | “ |
| 6th                   | “   | III.,           | “ | 202           | “ |
| 7th                   | “   | I.,             | “ | 3             | “ |
| 8th                   | “   | II.,            | “ | 103           | “ |
| 9th                   | “   | III.,           | “ | 203           | “ |

And so on.

#### X. Combination Tie-up in Two Sections. (“Tie-up Amalgamate.”)

This tie-up illustrates the point tie-up and the straight-through combined on the two-section system. In Fig. LXIII., a 600 machine is used for illustration; the

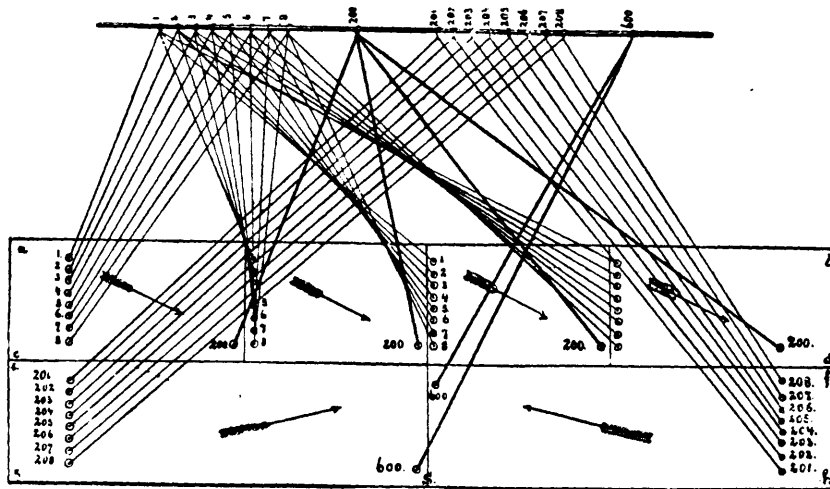

FIG. LXIII.

comber-board being divided into two parts: *a, b, c, d*, for No. 1 section; *e, f, g, h*, for No. 2 section.

No. 1 section requires the use of needles and hooks 1 to 200 on the straight-through principle, four divisions, taking 800 warp-threads.

No. 2 section requires the use of needles and hooks 201 to 600 on the point principle, one division, taking 800 warp-threads. The two sections thus use 1600 warp-threads in one repeat.

The threading of the harness is as follows: 1-201, 2-202, 3-203, etc., ending with 200-201.

This tie-up, as well as any changes in the arrangement and the number of needles, (but not changed in its principle), is used for double color figures of warps of large design, with a small all-over figure effect (No. 1 section) for the ground. Fig. LXIV. is executed on this tie-up.



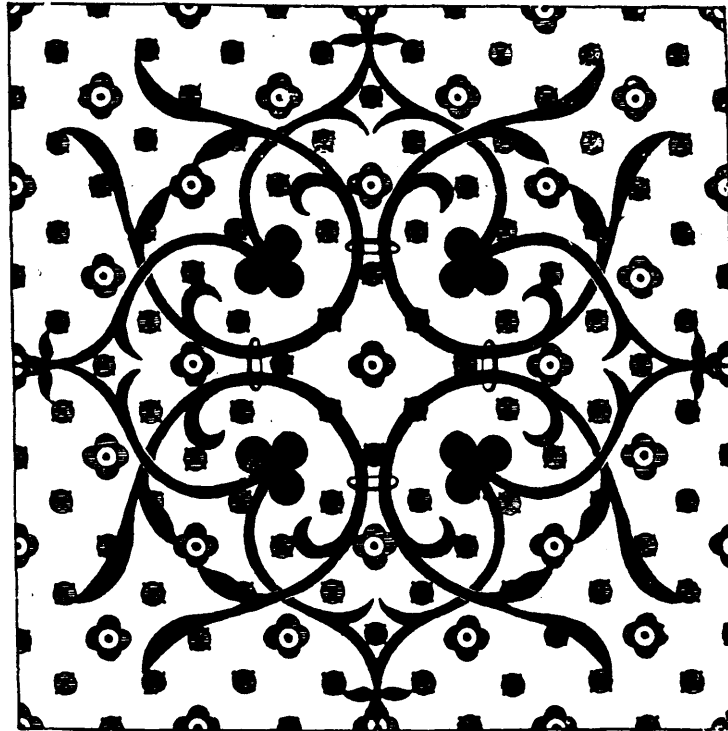

FIG. LXIV.

XI. The Straight-Through Tie-up in Four Sections.

Fig. LXV. shows 384 needles and hooks of the Jacquard machine, threaded in four sections in comber-board, *A*, *B*, *C*, *D*. The threading of comber-board is as follows :

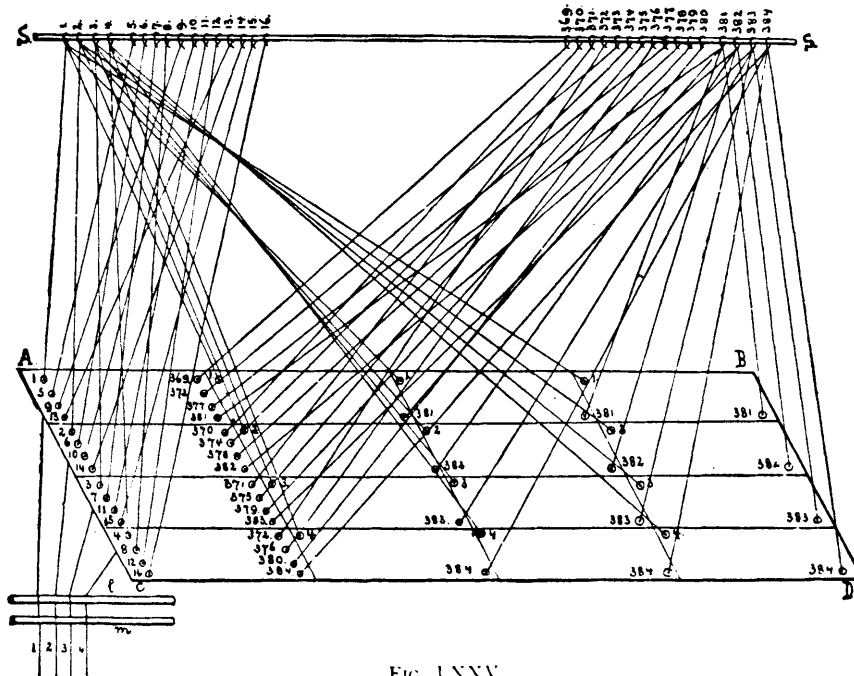

FIG. LXV.

|          |   |       |    |         |    |
|----------|---|-------|----|---------|----|
| 1st, No. | 1 | leash | in | section | 1. |
| 2d, "    | 2 | "     | "  | "       | 2. |
| 3d, "    | 3 | "     | "  | "       | 3. |
| 4th, "   | 4 | "     | "  | "       | 4. |
| 5th, "   | 5 | "     | "  | "       | 1. |
| 6th, "   | 6 | "     | "  | "       | 2. |
| 7th, "   | 7 | "     | "  | "       | 3. |
| 8th, "   | 8 | "     | "  | "       | 4. |
| 9th, "   | 9 | "     | "  | "       | 1. |

And so on. The threading of the harness is explained below the comber-board, *l* and *m* indicating the leash-strings; and warp-threads 1, 2, 3, 4, from leashes 1, 2, 3, 4, are indicated as threaded.

384 times 4 divisions make 1536 warp-threads.

## XII Tying-up of Jacquard Looms with Compound Harness attached.

Tying-up of Jacquard looms with extra compound harness, consists in applying two separate systems of harness in the loom. The warp-threads, after having passed through the Jacquard harness, are passed through harness in front. Each system of harness performs special duty, although they are both working the same warp. The Jacquard harness is used for forming the general design on a large scale; the second harness divides this pattern into detail, (twills, satins, or any other desired weave). The above tie-up is necessary in the manufacture of rich damasks and similar fabrics, where a large number of warp-ends is required, with a correspondingly small number of picks per inch. Suppose a damask fabric to contain 300 ends warp per inch, with only 75 picks per inch; or in the proportion of 4 to 1. Now, to employ this principle of making four ends warp equal to one filling, the size of the design would be produced in the fabric, but the richness, and also the fineness, of the face of the fabric would be entirely lost. To prevent this it should be the object of the designer to keep the fine warp-threads entirely on the surface, to interweave the proportion of ends varying between warp and filling (as in example above, four warp-threads) separately. This principle of textures requires the compound harness to be attached; or, in other words, a machine must be used which is capable of raising not only every alternate thread, but every third, fourth, or eighth thread, if required, for the formation of the body of the cloth.

Fig. LXVI. illustrates as plainly as possible the principle of tying-up to do this work, using a 100 Jacquard machine for figuring, comber-board threaded in three divisions, four heddles to each leash, eight compound harnesses.

In the tying-up of Jacquard harness four heddles to one leash are generally used, as illustrated at *c*, in Fig. LXVI.; each heddle containing one warp-thread. Fig. LXVII. shows the arrangement of these four warp-threads, when using only one heddle to each leash, but in which the mail contains four eyes. This method is less frequently employed. Instead of using a 100 machine, as in Fig. LXVI.,

|                                  |              |                  |                    |
|----------------------------------|--------------|------------------|--------------------|
| A 200 machine (straight-through) | will require | 800 warp-threads | for each division. |
| 300                              | "            | "                | "                  |
| 400                              | "            | "                | "                  |
| 600                              | "            | "                | "                  |
| 900                              | "            | "                | "                  |
| 1200                             | "            | "                | "                  |

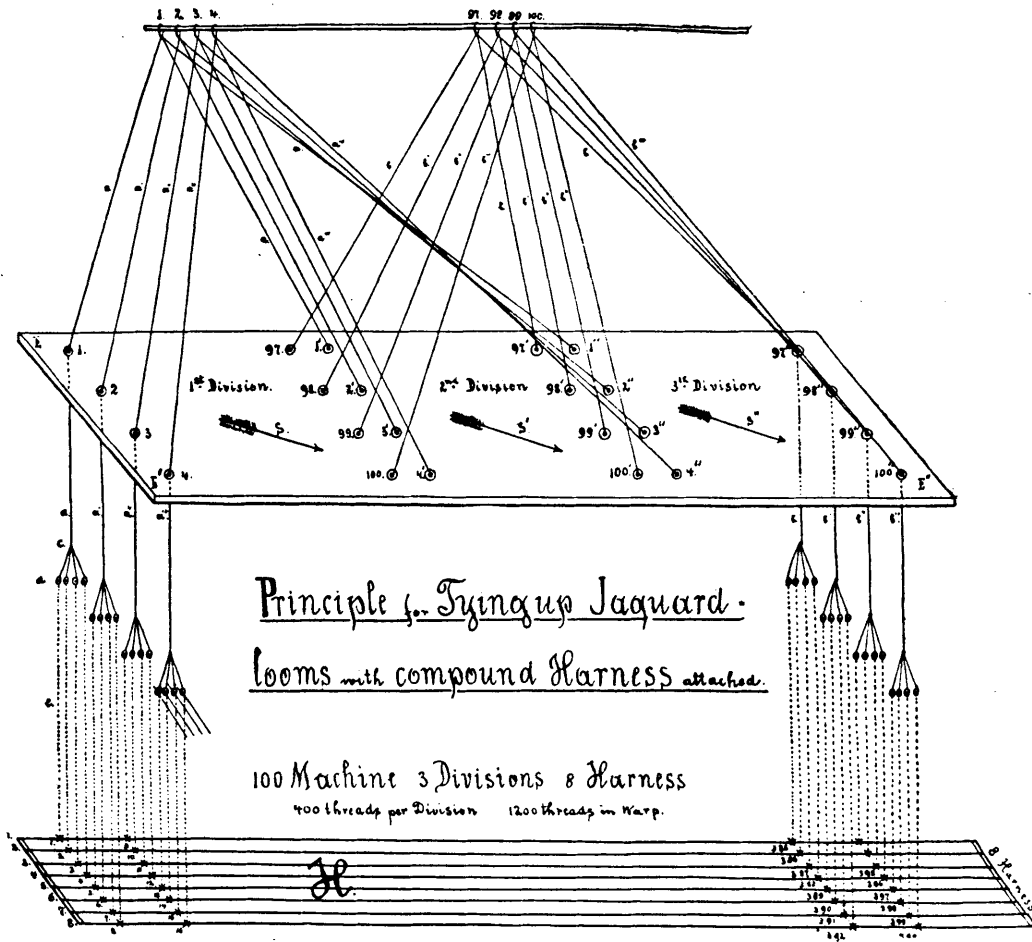

FIG. LXVI.

To change the tie-up principle from the straight-through method to the point method, taking a 1200 machine using four heddles per harness-cord, 9600 warp-threads will be required for each division for repeat of pattern.

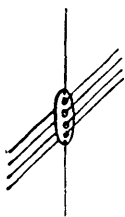

FIG. LXVII.

This little example plainly shows the great advantage of this method of tying-up looms for making the finest damasks, etc.

To explain the general method of this tie-up, commence with Fig. LXVI., which represents a 100 machine, three divisions, four heddles to one leash, eight compound harnesses.

It will not be necessary to explain the threading of the comber-board, as

this is always done on the same plain principles. The four heddles of the first row deep of comber-board emerge below the board at the beginning of the first division, marked *a*, *a'*, *a''*, *a'''*. The first row deep in comber-board in the first division, and the last row deep in comber-board in the third division only are shown; but as these two rows also indicate the first and last rows in the Jacquard machine, and as the principle of *a*, *a'*, *a''*, *a'''*, and *b*, *b'*, *b''*, *b'''*, has to be observed in every one of these 75 rows deep in width of comber-board *E'* to *E''* taken, it will explain the tie-up for the entire number. At *c*, in leash *a*, four distinct heddles are adjusted; the same thing is repeated in every one of the eight leashes extended in drawing below the comber-board, giving in return, thus: four heddles and three divisions in a 100 machine =  $4 \times 3 \times 100$ , or 1200 warp-threads for the entire fabric.

Now, following the first heddle downwards on leash 1, *a*, *c*, marked on drawing, *d*, (indicated by dotted lines), No. 1 harness of the compound harness, *H*, is reached. The cross X on this harness indicates that the warp-thread drawn through mail fastened on heddle, *d*, must also be drawn through No. 1 harness; the next heddle from the same leash will reach No. 2 harness; and so on until No. 4 harness is taken up, which will finish No. 1 harness-cord of No. 1 leash in the first division. The second harness-cord, *a'*, will use harness 5, 6, 7, 8; the third harness-cord, *a''*, will use harness 1, 2, 3, 4, over again, as used by *a*; the fourth harness-cord, *a'''*, will use harness 5, 6, 7, 8, over again, as used by *a'*.

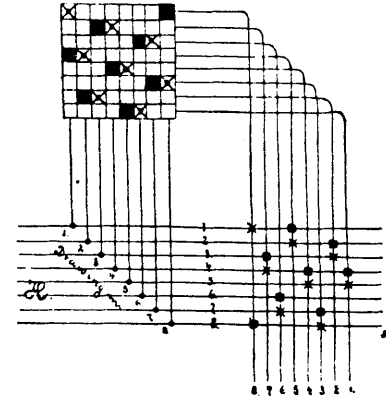

FIG. LXVIII.

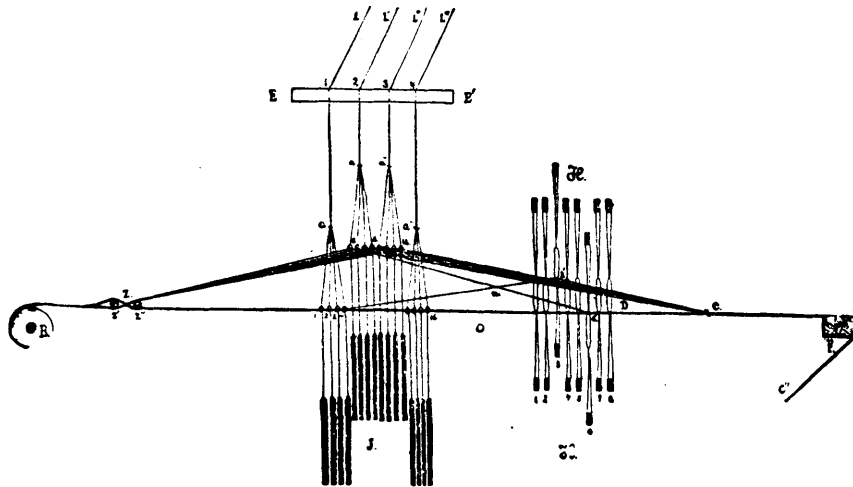

FIG. LXIX.

Continue in this manner until leash 100 in the first division on harness 5, 6, 7, 8, is finished. The second and third divisions strictly repeat the first.

Fig. LXIX. represents the side elevation for Fig. LXVI. In both of these drawings some of the letters and figures correspond, as follows: harness-cords

$a, a', a'', a'''$ , in first row deep of comber-board,  $E, E'$ .  $H$  shows compound harness set 1, 2, 3, 4, 5, 6, 7, 8; figures 1, 2, 3, 4, on top of comber-board represent the first row deep from the front elevation in drawing.

New letters:  $B$ , the warp-beam;  $Z$ , the lease of the warp formed by rods  $Z'$  and  $Z''$ ;  $O$ , the distance between the Jacquard harness and compound harness set  $H$ .  $D$ , the shed, as formed in loom when weaving. For illustration of this shed pick No. 7 in Fig. LXVIII., shows that leashes 2 and 3, or  $a'$  and  $a''$ , are raised at the same time. Leashes 1 and 4, or  $a$  and  $a'''$ , are not raised.

The principle of forming the shed for picking the shuttle will be more particularly explained later on by Figs. LXX. to LXXV.

At  $c$ , in Fig. LXIX., the beginning of the shed is shown; also the last woven part of the fabric,  $c, c', c''$ , which is indicated as passing around the breast-beam,  $F$ .  $L, L', L'', L'''$ , indicate leashes 1, 2, 3, 4, extending to the Jacquard machine towards neck-cords 1, 2, 3, 4.

Fig. LXX. represents a warp-thread forming the bottom part of a shed. Mail,  $L$ , and harness,  $H$ , occupy a position similar to that of mail and harness for warp-thread passing through No. 1 heddle of leash  $a$ , and harness 1 in Fig. LXIX.

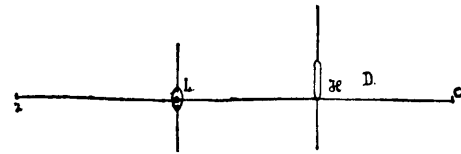

FIG. LXX.

Warp thread No. 2, passing through leash  $a$ , and harness 2, in Fig. LXIX. is the same.

|   |   |     |   |   |          |   |    |   |   |   |
|---|---|-----|---|---|----------|---|----|---|---|---|
| " | " | 4,  | " | " | $a$ ,    | " | 4, | " | " | " |
| " | " | 13, | " | " | $a'''$ , | " | 5, | " | " | " |
| " | " | 15, | " | " | $a'''$ , | " | 7, | " | " | " |
| " | " | 16, | " | " | $a'''$ , | " | 8, | " | " | " |

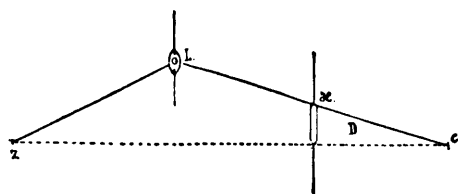

FIG. LXXI.

Fig. LXXI. shows a warp-thread forming part of the top shed by raising the leash; hence mail,  $L$ , is shown raised. The compound harness is supposed to be resting, which allows the warp-thread to slide up to the height of the required size of shed. This figure illustrates plainly the following warp-threads in Fig. LXIX.

Warp-thread No. 5, passing through leash  $a'$ , and harness 5, in Fig. LXIX. is the same.

|   |   |     |   |   |         |   |    |   |   |   |
|---|---|-----|---|---|---------|---|----|---|---|---|
| " | " | 7,  | " | " | $a'$ ,  | " | 7, | " | " | " |
| " | " | 8,  | " | " | $a'$ ,  | " | 8, | " | " | " |
| " | " | 9,  | " | " | $a''$ , | " | 1, | " | " | " |
| " | " | 10, | " | " | $a''$ , | " | 2, | " | " | " |
| " | " | 12, | " | " | $a''$ , | " | 4, | " | " | " |

Fig. LXXII. illustrates the side view of a warp-thread where the hook of the Jacquard is not raised; hence, the mail remains in its resting place. Following the warp-thread towards  $c$ , the compound harness is shown raised, thus forming part

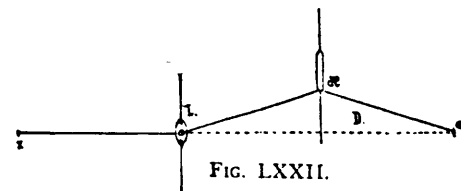

FIG. LXXII.

of the top of a shed. This figure is designed to show the passage of the warp-thread through mail No. 3 of leash  $a$ , and harness No. 3, in Fig. LXIX.

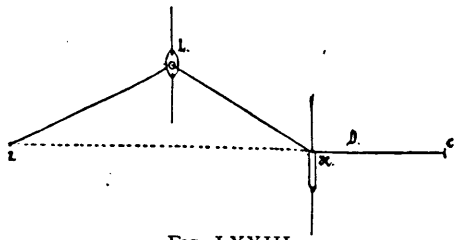

FIG. LXXIII.

Fig. LXXIII. illustrates a thread forming part of a lower shed. In the drawing the mail is raised, but at the same time the heddle of harness is lowered, compelling the thread to rest on the bottom of the lay. This figure is designed to show warp-thread passing through mail No. 6, of leash  $a'$ , and harness No. 6, in Fig. LXIX.

Fig. LXXIV. is a side view of a thread forming the upper part of a shed where mail and harness have been raised the same as in Fig. LXIX., the warp-thread passing through mail No. 11 of leash,  $a''$ , and harness No. 3.

Fig. LXXV. illustrates mail not raised and harness down.

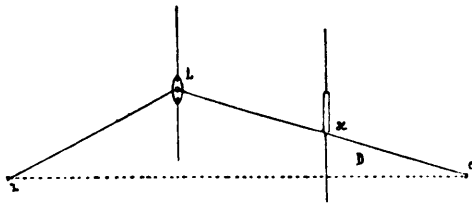

FIG. LXXIV.

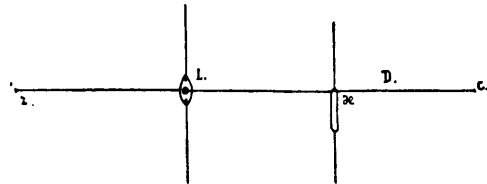

FIG. LXXV.

In Figs. LXX. to LXXV. the following letters correspond with the same letters in Fig. LXIX. :  $Z''$ , nearest lease-rod to Jacquard harness;  $D$ , shed for picking shuttle;  $C$ , starting point of shed or last woven place of fabric.

#### *The Kind of Heddles Required for Compound Harness.*

The eyes of these heddles are much longer than those of common heddles. They must be sufficiently long to allow the six movements illustrated in Fig. LXX. to LXXV., hence the height of these heddle eyes will influence the height of the shed.

#### *Working the Compound Harness by a Separate Machine.*

For working compound harness a separate small witch-loom is generally used, thus saving, to a great extent, the Jacquard cards. In this manner the ground may be easily altered without changing any cards, it being only necessary to change the small set of cards on the witch-loom controlling one repeat of the body weave for the harness. The number of picks for the harness can also be readily adjusted to one change in the Jacquard figure without disturbing the cards of any consequence. For example: in manufacturing a damask fabric, suppose four harness picks make one change of figure in the Jacquard machine, and it is necessary to reduce these four picks to one change of figure, on account of having to use some heavier filling, or other similar reason; this alteration can be easily made when using two separate machines.

*Number of Compound Harness to Use.*

The number of harness used is regulated by the weave required for raising, and the weave required for lowering.

The number of harness may vary to a large degree, as we may use any suitable weave from the 4-leaf twill up to the 16-leaf satin. As a general rule, for fine damasks we use the 8-leaf satin, requiring 8 harness.

*Positions of Compound Harness During Weaving.*

FIG. LXXVII.

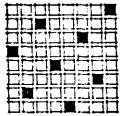

Filling Weave as raised in the upper shed by harness.

■ Risers.  
□ Sinkers.

There are three distinct positions for the harness: 1st, centre; 2d, up; 3d, down.

Fig. LXVIII., p. 60, illustrates the 8-leaf satin combining filling and warp up in one design.

*A few Different Weaves for Working Compound Harness.*

FIG. LXXVI.

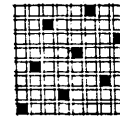
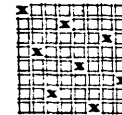

FIG. LXXVIII.



Warp Weave to interweave in lower shed through harness.

□ Warp on face.  
X Warp down.

FIG. LXXIX.

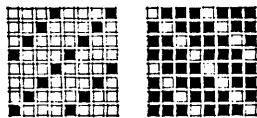

A. Filling up. B. Warp up.

A great variety of combinations of different weaves for this class of textile fabrics exist. It is only necessary to illustrate a few more examples to guide us in finding the principles underlying these changes.

FIG. LXXX.

5-LEAF SATIN.

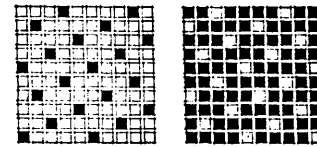

Filling. Warp.

FIG. LXXXI.

7-LEAF SATIN.

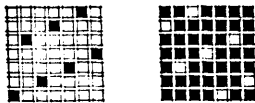

Filling. Warp.

FIG. LXXXII.

8-LEAF SATIN. 8-HARNESS BROKEN TWILL.

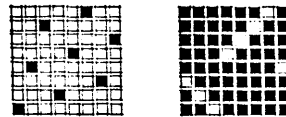

Filling. Warp.

FIG. LXXXIII.

8-LEAF SATIN. 8-HARNESS FANCY TWILL.

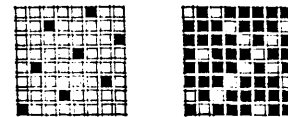

Filling. Warp.

Fig. LXXIX. is an example of warp and filling, binding in a 4-leaf twill. Both systems are illustrated for a clear understanding: ■ Fig. A, indicates the raising of the harness for forming the upper part of the shed; □ Fig. B, indicates the rotation of drawing warp-threads from the upper shed into the lower shed. Drawing-in draft is for 4-harness (straight).

FIG. LXXXIV.

10-LEAF SATIN. 10-LEAF SATIN.

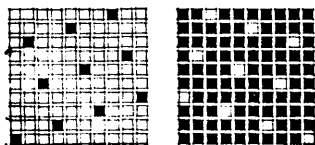

Filling. Warp.

FIG. LXXXV.

10-LEAF SATIN. 5-HARNESS SATIN.

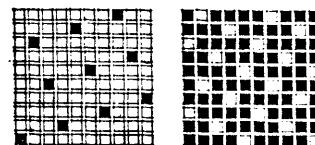

Filling. Warp.

FIG. LXXXVI.

12-HARNESS SATIN.

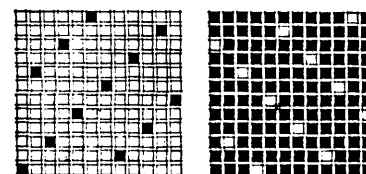

Filling. Warp.

### XIII.—Tying-up Jacquard Looms for Gauze Fabrics.

Gauze fabrics are produced by a separate system of weaves, which have the peculiar characteristic of warp-threads not lying parallel to each other. One kind of this warp is called the “douping warp” or “whip-threads;” these are twisted around the ground-warp. The ground-threads, as well as the whip-threads, which work together, must be drawn into one dent.

Jacquard gauze can be worked in various ways; for example: One whip-thread against one or more ground-threads. More than one whip-thread against one or more ground-threads.

There are two methods of tying-up for gauze fabrics: 1st. A tie-up in which the doups are worked by one, two, three or four shafts in front of the Jacquard harness. 2d. A tie-up in which the gauze figuring is done all over the fabric, requiring each doup to be arranged for working separately. If the ground-threads and whip-threads are worked from the same Jacquard machine, the latter must be divided into two sections: 1st section for the ground-threads with ground heddles; 2d section for the whip-threads with standard heddles.

If a fabric contains the gauze in the form of a stripe, arranged one end ground and one end whip, the same number of hooks are required for the ground and whip-threads of each section, and an extra dead harness must be employed; but if this arrangement of one end ground and one end whip must form figures, then the ground and whip-threads must form the first section, and the whip-threads alone the second section. In this case the second section requires only half as many hooks as the first; and for the same reason, if we are forming figures with two ground-threads and one whip-thread, the first section will contain three times as many hooks as the second, etc. Very often two whip-threads are used for twisting, in which case they must be drawn together in the doup. If several whip and ground-threads are drawn into one reed they usually work independently at first on a regular weave; following this is the gauze weave formed by a certain number of whip-threads raised either on the left or right of the ground-threads contained in the same dent. This movement brings into operation the second section of the machine containing the harness-cords for the standard heddles. The technical terms for these various combinations are: single-thread gauze, double-thread gauze, triple-thread gauze, etc.

The tie-up most generally used requires two-thirds of the needles for ground heddles and one-third of the needles for standard heddles; hence, if using a 200 machine we find: 128 needles and hooks for the ground heddles, and 64 needles and hooks for the standard heddles. [See Fig. LXXXVII., p. 65.]

The comber-board is divided into two sections. The rear part ( $\frac{2}{3}$ ) is used for the ground, the front part ( $\frac{1}{3}$ ) is used for the standard.

#### *Threading of the Harness.*

Thread the warp into the ground heddles in the same manner as a common straight-through tie-up. Then take the first left-hand thread of the warp and draw it through the doup. The next two warp-threads draw above the first one on the



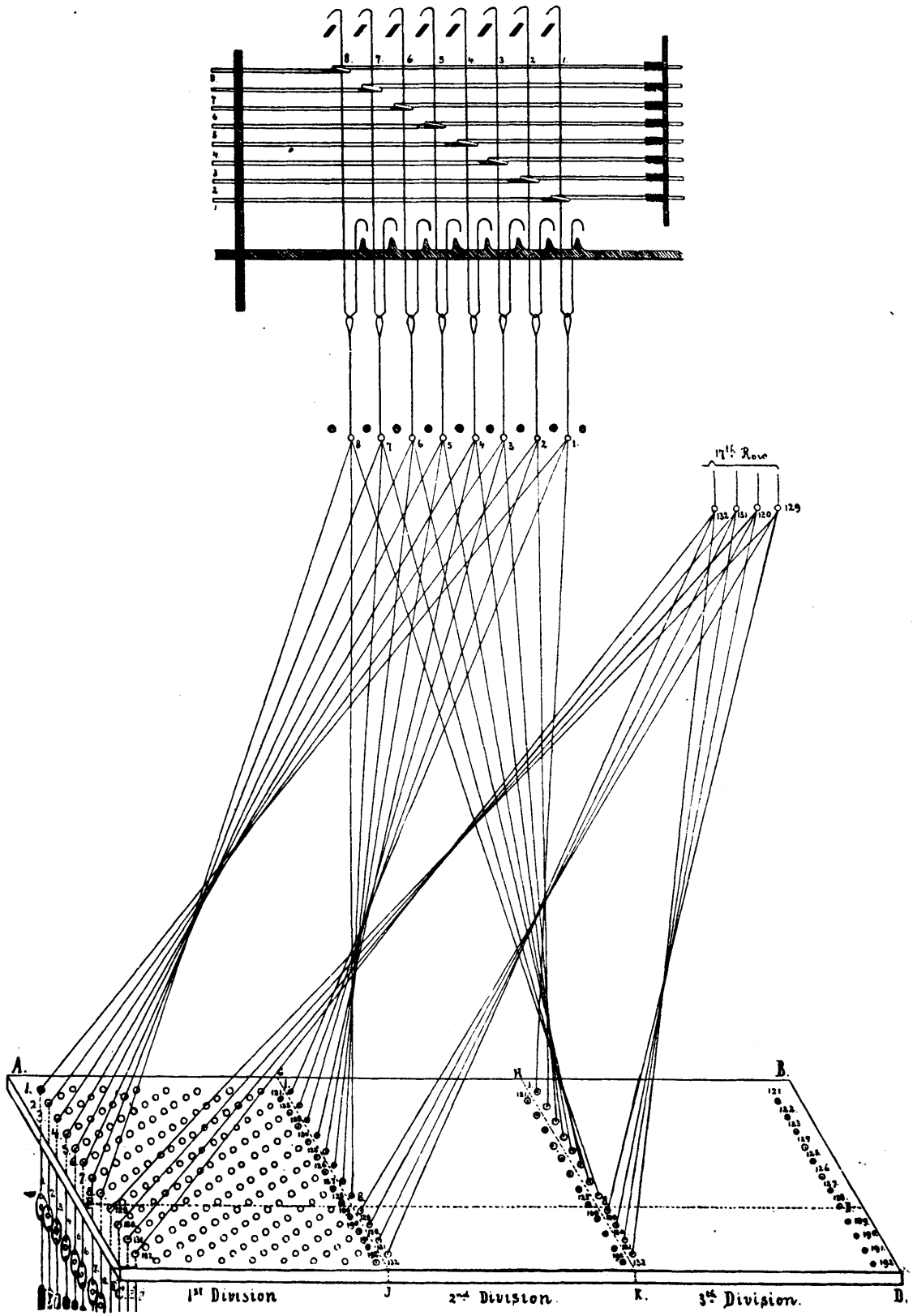

FIG. LXXXVII.

left-hand side of the same doup. These three warp-threads must be drawn together in one dent. After drawing the first pair in one dent, leave one, two, or more dents empty, according to the fabric. The 4th, 5th and 6th warp-threads, also each subsequent pair, are threaded the same as the first.

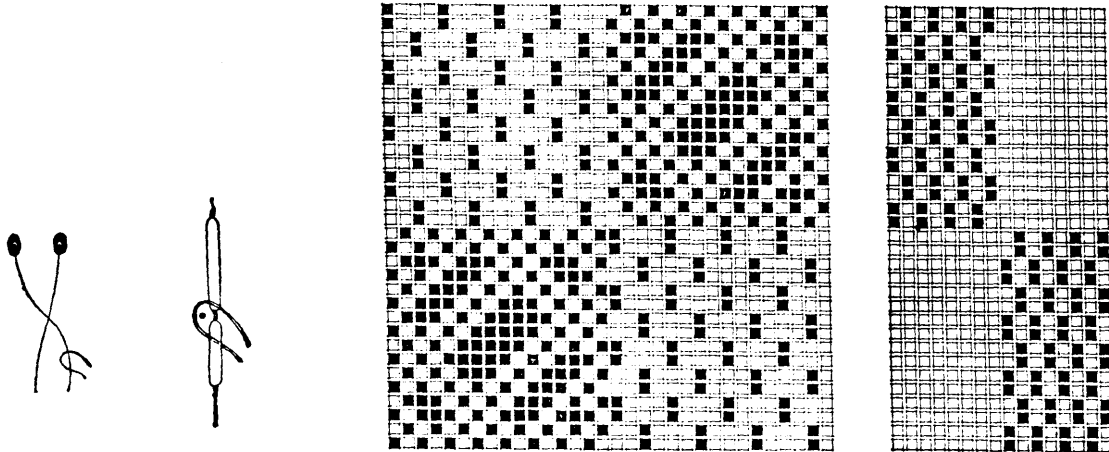

FIG. LXXXVIII. FIG. LXXXIX.

FIG. XC.

Figs. LXXXVIII. and LXXXIX. are designed for illustrating this point. The lingoes for the doups are about one-half the weight of those used for the ground heddles.

Fig. XC. represents a fancy gauze to be executed in this manner.

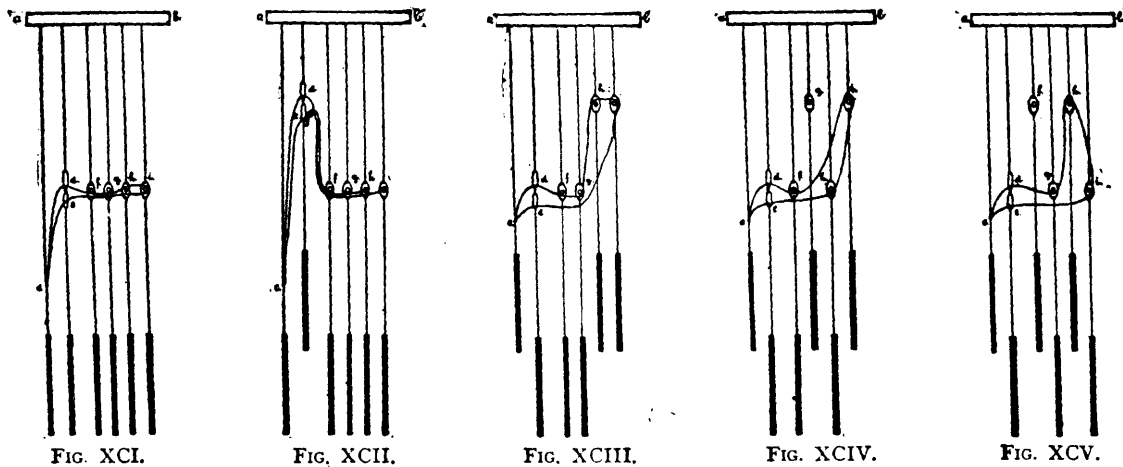

Fig. XCI. represents the threading of the harness for a gauze fabric: *f*, *g*, first and second warp-thread, over the doup; *h*, *i*, third and fourth, through the doup.

Figs. XCII. and XCIII. illustrate the two movements of the harness in the gauze weave.

Figs. XCIV. and XCV. illustrate the movements of the harness in the regular weave: *a*, *b*, represents the comber-board; *c*, the place where the doup is fastened to the dead harness; *d*, *e*, the standard heddle; *f*, *g*, *h*, *i*, the mails of the common heddles.

The following are the fourteen different movements that might be required in regular weaving. The figures show the number of threads up and the number down, thus:  $\frac{1}{3}$  equal first warp-thread up; second, third, and fourth down.

1.  $\frac{1}{3}$  = *f* up.
2.  $\frac{1}{2}$  = *g* up.
3.  $\frac{1}{2-1}$  = *h* up, doup raised.
4.  $\frac{1}{3}$  = *i* up, doup raised.
5.  $\frac{2}{2}$  = *f* and *g* up.
6.  $\frac{2}{1-1}$  = *g* and *h* up, doup raised.
7.  $\frac{2}{2}$  = *h* and *i* up, doup raised. [Illustrated by Fig. XCIII.]
8.  $\frac{1-1}{1}$  = *f* and *h* up, doup raised. [See Fig. XCV.]
9.  $\frac{1-1}{2}$  = *f* and *i* up, doup raised.
10.  $\frac{1-1}{1-1}$  = *g* and *i* up, doup raised. [See Fig. XCIV.]
11.  $\frac{3}{1}$  = *f*, *g*, and *h* up, doup raised.
12.  $\frac{3}{1}$  = *g*, *h*, and *i* up, doup raised.
13.  $\frac{2-1}{1}$  = *f*, *g*, and *i* up, doup raised.
14.  $\frac{1-2}{1}$  = *f*, *h*, and *i* up, doup raised.

These fourteen different movements cover all the possible changes in regular weaving. The movement (7) illustrated in Fig. 8, in addition to forming the regular weave, is also necessary to the formation of the gauze weave.

These few explanations clearly show the great variety of effects possible for the designer; for he can figure with the regular method of weaving, and can also figure gauze weaving to exchange with regular weaving, forming a separate design on the fabric.

---

## Modifications of the Single Lift Jacquard Machine.

Having thoroughly described the construction and action of the regular Jacquard machine, it now remains to illustrate and explain its modifications. Among the most prominent are:

- 1st. The Double Lift Single Cylinder Jacquard Machine.
- 2d. The Double Lift Double Cylinder Jacquard Machine.
- 3d. The Arrangement of Substituting "Tail-cords" in place of the Hooks, etc.

### I. Double Lift Single Cylinder Jacquard Machine.

The principle of this machine consists in raising the warp-threads any number of times in succession without allowing the shed to close, thus performing the work in nearly half the time, and with less wear and tear on the warp.

Fig. XCVI. represents the sectional cut of one row across all the griffe-bars. The machine selected for the illustration is of the 12-row type. Jacquard machines of this description have two hooks to one needle; therefore in the drawing twenty-

four hooks are represented. Two griffes are provided, each working every alternate hook.

In Fig. XCVI. the sectional cut of both griffes is shown, and in Fig. XCVII. the top view of both griffes; the first set is represented shaded, the second black.

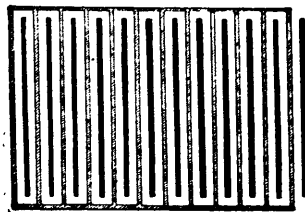
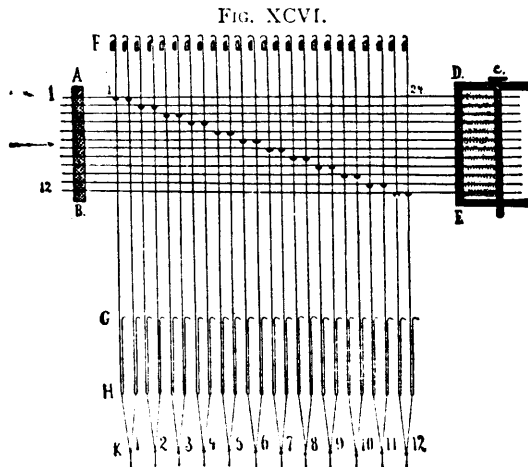

the former requires hooks Nos. 1, 3, 5, 7, 9, 11, 13, 15, 17, 19, 21, 23, and the latter Nos. 2, 4, 6, 8, 10, 12, 14, 16, 18, 20, 22, 24.

This arrangement permits either hook to be lifted separately by the griffes, and a corresponding elevation of the leash. As these griffes work in opposition, one descends while the other ascends; this motion prevents the leash from dropping the entire length of the cords, since the ascending griffe catches it at half distance as the two griffes pass each other. In this operation the shed is never entirely closed, and a corresponding gain in speed is attained. It will thus be seen that the "double lift" single cylinder has great advantages over the ordinary machine. Of course, the warp-thread must make its complete journeys up and down when called for by the design; but when once up, it need not be brought down until absolutely required by the pattern. The

warp is thus subjected to less friction in working, and it is possible to use yarns with less twist and obtain good results.

The advantages arising from not closing the shed may be seen in the following example of a warp-thread working on an 8-leaf satin, in which seven picks are up in succession.

By the single lift machine this warp-thread must travel seven times up and seven times down, thus closing the shed absolutely seven times, with a corresponding wear and tear. The double lift single cylinder arrangement does not require the warp-thread to make these seven complete journeys to the "race-board" of the lay, but instead it makes seven half trips. The saving may be shown by the following analysis: Single lift machine, warp-thread, seven picks up in succession, in 8-leaf satin (warp-face) requiring fourteen complete movements.

Double lift single cylinder machine requiring for the same effect:

|                              |   |   |
|------------------------------|---|---|
| Up the first time,           | = | one complete movement.                    |
| Six times down,              | } | half movements, = six complete movements. |
| Six times up,                |   |   |
| Down the last time,          | = | one complete movement.                    |
| Or eight complete movements. |   |   |

Showing the utility of the two machines to be to each other as 8 to 14, or 4 to 7.

Fig. XCVIII. illustrates the complete double lift single cylinder Jacquard machine. In this drawing both griffes are distinctly visible; also their mode of operation by means of the double-acting lever. This machine has the set of hooks for each griffe-bar protected by a plate of sheet iron, thus steadying the hooks in their motion, and enabling smaller crooks to be used for the latter.

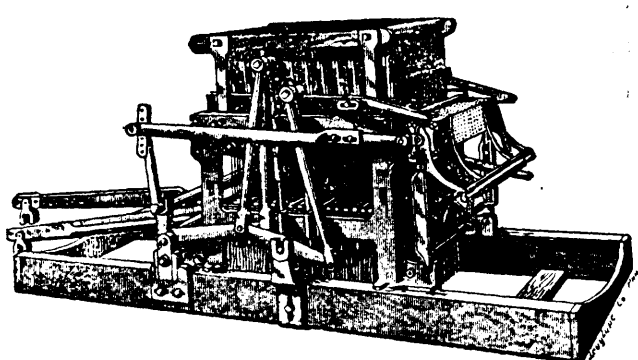

FIG. XCVIII.

Fig. IC. represents a double lift single cylinder Jacquard machine as built by Thomas Halton, Philadelphia, attached to a regular broad loom, (Knowles or Crompton), and tied-up for upholstery work. The griffe-bars in this Jacquard machine are constructed of such height that when lifted they never rise above the crooks of the hooks, which are thrown out of operation by the descent of the other griffe.

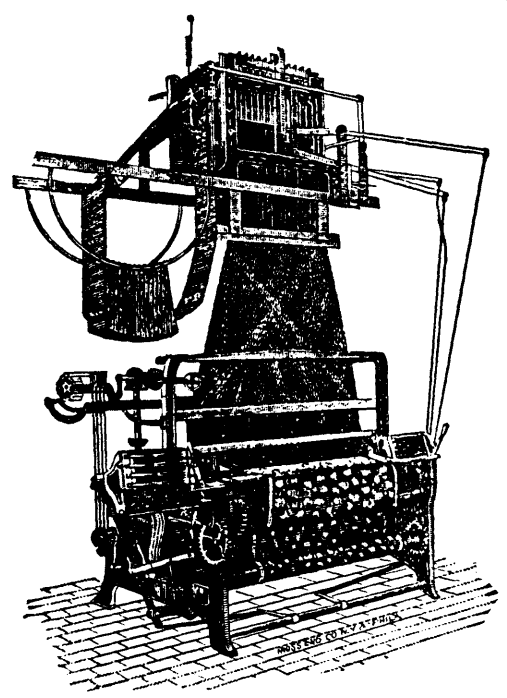

FIG. IC.

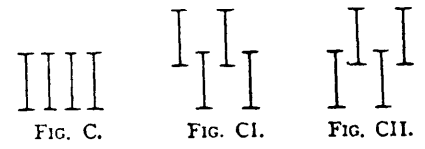

Fig. C., hooks at rest.  
 Fig. CI., hooks 1 and 3, etc., raised, = 2 and 4, etc., at rest.  
 Fig. CII., hooks 2 and 4, etc., raised, = 1 and 3, etc., at rest.

**II. Double Lift Double Cylinder Jacquard Machine.**

The principle of this machine consists in the combination of two separate Jacquard machines. Two hooks (one of each machine) are connected to one leash of the Jacquard harness, and as each machine is operated alternately, a high speed is attained, which is the purpose of the

machine. For example: 140 picks per minute (speed of loom) only requires 70 picks per minute from each part of the double lift double cylinder.

In Fig. CIII. this is clearly illustrated. It shows two 12-row machines (*E* and *F*) combined, thus giving 24 griffe-bars for the complete double machine, as the griffes work within each other. As explained for double lift single cylinder, every alternate bar is connected with a separate griffe, and these two griffes are worked alternately on the same double lever arrangement.

*O* to *P* and *O'* to *P'*, represent the two needle-boards; *P* to *R* and *P'* to *R'*, represent the two corresponding needle-boxes.

These double lift double cylinder Jacquard machines are mostly used in the manufacture of turkey-red goods and similar table-cover fabrics, using tie-ups similar to the one illustrated below, which is a combination of the straight-through and point tie-up, which may be alluded to once more by way of explanation in this particular case.

The illustration represents a double lift double cylinder machine containing two 600 machines, which equals an ordinary 600 machine for the tie-up.

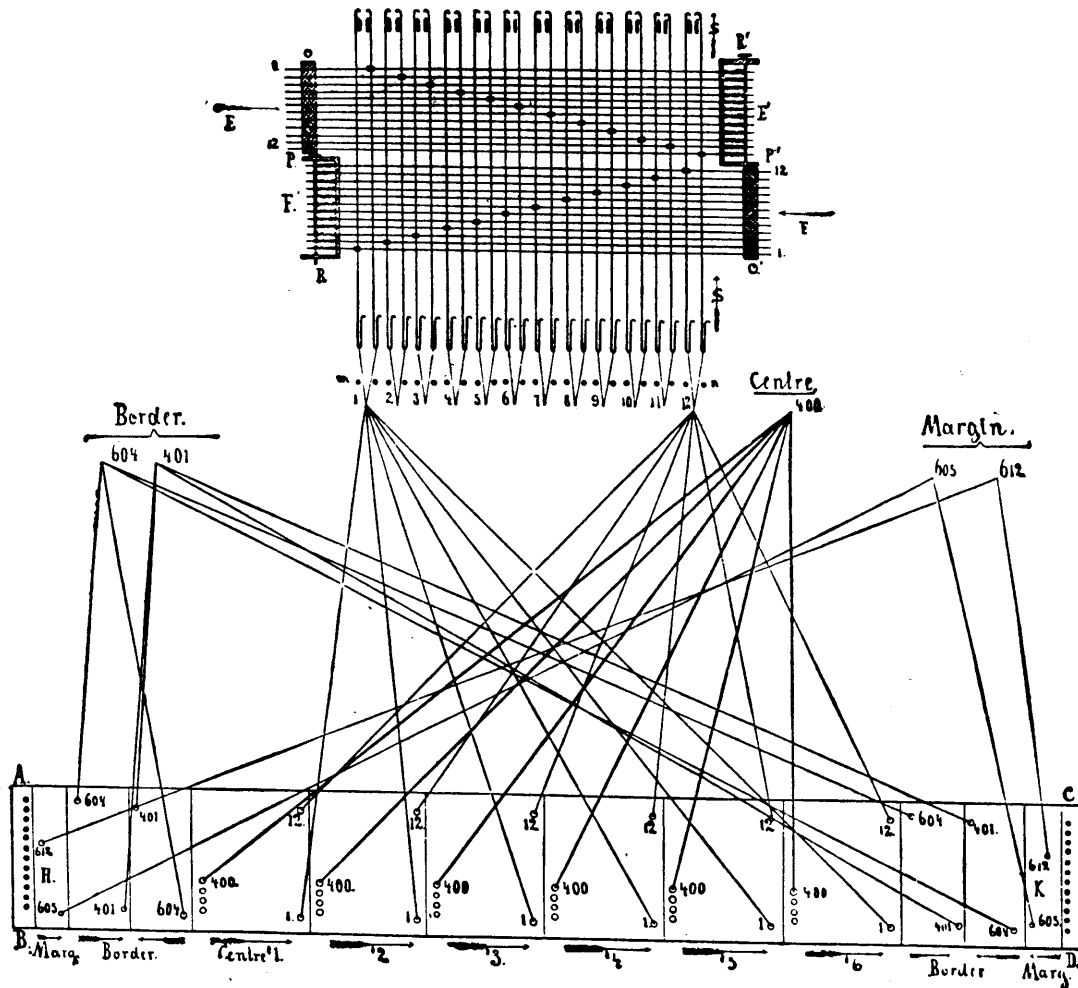

FIG. CIII.

This tie-up contains six divisions for the centre straight-through, and requiring leashes 1 to 400 from each part of the double machine. Leashes 1, 12, and 400 (heavy lines) only are illustrated in drawing.

The borders are constructed on the point tie-up, and require leashes 401 to 604 from each part of the double machine. The first and last leash only are illustrated. The margins between border and selvedge are worked by leashes 605 to 612. Centre and border are 12 rows deep, arranged in the comber-board; the margin 8 rows deep, on account of working it (as is generally done) on an 8-leaf

satin. One complete row in machine, (both parts), as well as in the comber-board, (illustrated on each side in drawing), is left for the selvedge.

Fig. CIV. represents this machine (built by Thomas Halton, Philadelphia,) attached to a Clipper loom. In this drawing both sets of cards (one to contain the even numbers, and the other the uneven numbers) are clearly visible, and also the double lever arrangement for working every cylinder alternately. As the cylinders run at only half speed, the wear on the cards is reduced to a minimum.

### III. The Substitution of Tail-cords for Hooks.

Jacquard machines having this construction are generally employed in the manufacture of ingrain carpets.

Fig. CV. represents the sectional cut of one row of needles across the machine; also the necessary boards for

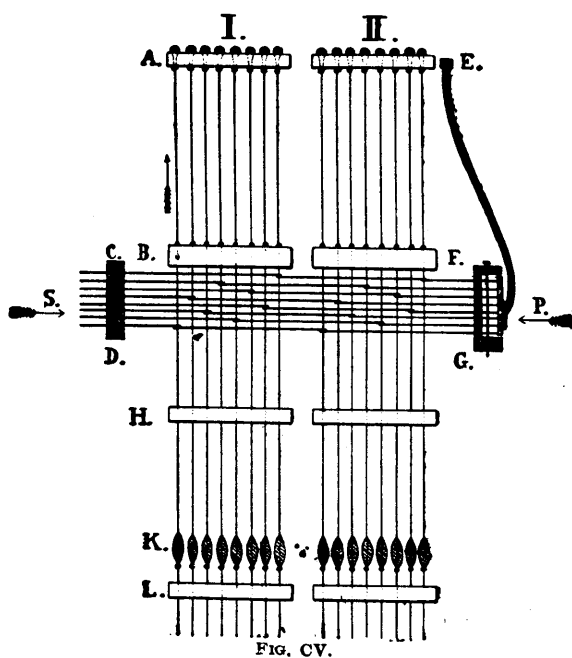

FIG. CV.

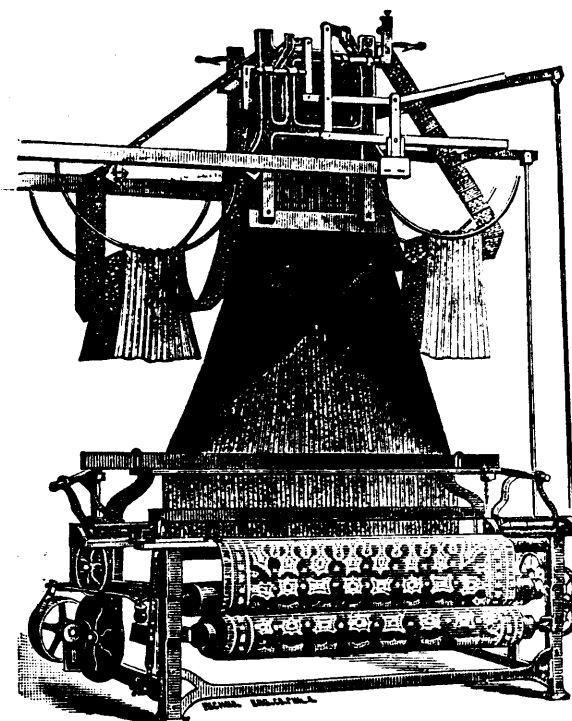

FIG. CIV.

guiding and operating the tail-cords. This machine consists of two divisions (I. and II.,) which are worked alternately for the common 2-ply ingrain carpet.

*A*, represents the top board, to which the tail-cords are fastened around a wire by knot shown below the boards. Each board is  $6\frac{1}{4}$  by  $\frac{3}{4}$  inches, with a distance of  $1\frac{1}{4}$  inches between them.

*B*, represents the "Lifter-boards" (trap-boards) which are shown in top view in the special article devoted to the manufacture of ingrain carpets. (Fig. CIX., p. 74.) Its dimensions are  $6\frac{1}{4}$  inches by 1 inch. Distance from top-boards to lifter-boards,  $9\frac{1}{4}$  inches. *C* to *D*, needle-board. Arrow, *S*, the direction of working the cylinder towards the needles. *F* to *G*, the needle

box with its pin for holding the needles in position. Each needle is connected to two tail-cords, as indicated in the drawing, one for figure and one for ground. *H* and *L* are the two guide-boards for the tail-cords. Distance from *B* to *H*,  $7\frac{1}{4}$  inches, from *H* to *L*,  $8\frac{1}{2}$  inches. Dimensions of each guide-board,  $6\frac{1}{4}$  inches by  $\frac{3}{4}$  inch. Each tail-cord is weighted by a small lead weight, as shown at *K* in drawing.

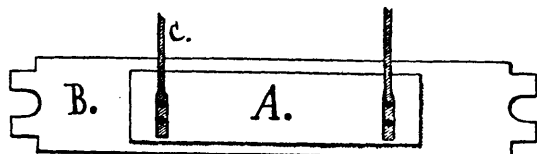

FIG. CVI.

pressing the needles, *A*. *C* shows the hanger, which is attached (movable) to the top of the machine. [See *E*, in Fig. CV.]

In this machine the springs for the needles are omitted, and a board large enough to cover the ends of all the needles, substituted. [See arrow, *P*.]

Fig. CVI. illustrates the rear view of the needle-box, *B*, and the board for

## Tying-up of Jacquard Harness for Two-ply Ingrain Carpets.

WITH A GENERAL DESCRIPTION OF THE WORKING OF THE LOOM AND  
CONSTRUCTION OF THE FABRIC.

Two-ply Ingrain Carpet is an article composed of two fabrics, produced on the regular double-cloth system. These two fabrics are arranged in the loom to form figures by a simple exchanging of positions. A great variety of colors may be put into each of these separate fabrics, (ground and figure), and the most elaborate designs may be used. On every part of the carpet where these two fabrics do not exchange, each works on the plain weave. The exchanging of these two fabrics binds both into one, thus forming the ingrain carpet. In the manufacture of this carpet four sets of warp-threads, and also four sets of filling-threads are generally employed; but, if occasionally more or less should be used, in warp or in filling, or in both, in the same fabric, the principle of exchanging is still observed. If employing four sets in warp and filling, two sets of each are used for forming the figure, the other two sets forming the ground, each of the figure-threads having as its mate one of the ground-threads. These threads are so arranged that when a figure-thread appears upon the face of the fabric its mate appears upon the back, and when the figure-thread appears upon the back the corresponding ground-thread appears upon the face.

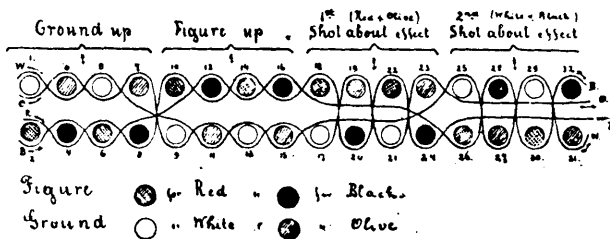

FIG. CVII.

To give a clearer understanding of the foregoing, a sectional cut of an Ingrain carpet fabric is given in Fig. CVII.