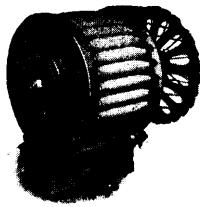


HAND BOOKS OF THE TEXTILE INDUSTRY, VOL. 2

**NARROW WOVEN FABRICS**

E. A. POSSELT, PHILADELPHIA



# **NORTHROP LOOMS**

**TRADE MARK REGISTERED**

---

**EARN MORE WAGES FOR THE WEAVER  
LARGER DIVIDENDS FOR THE MILL**

---

**DRAPER COMPANY  
HOPEDALE MASS.**

J. D. Cloudman, Southern Agent, 188 South Forsyth St.,  
Atlanta, Ga.

**CROMPTON & KNOWLES**

**LOOM WORKS**

---

**Builders of LOOMS for every  
known woven fabric**

---

**WORCESTER, MASS.**

**Providence, R. I.**

**Philadelphia, Pa.**

**Posselt's** <sup>W</sup>  
**Textile Journal**  
*A Monthly Journal of the Textile Industries*

*Table of Contents*

Dictionary of Weave Changes	5
Review of the Month's Publications: News and Journal Work	6
Ribbon, Trimmings, Edgings, Etc.	11
Dyeing Blue Silk	14
Dyeing Blue Silk	15
Silk Throwing	15
Woolen Cloth	16
Cotton Spinning: The Ring Frame	16
Review of the Market	20
Microscopical Comparison of Flannel and Plainweave	24
Obituary of Sir John Lubbock	27
Shoddy and Waste Trade	27
Shoddy and Waste Trade	27
Natural and Artificial Light upon Colors	29
How to Test the Various Finishes of Cotton Goods	31
China's Effects on Silk	31
The Market for Sewing Cottons	34
Review of the Month's Publications: News and Journal Work	34
Dyeing and Finishing of Hosiery and Knit Goods	38
Batterworth's Gas Squeegee Machine	41
Bill News	41

Printed by Messrs. J. B. Riddle, Philadelphia, Pa. under the Joint Management of Messrs. J. B. Riddle & Co., Philadelphia, Pa.

**E. A. Posselt, Publisher, 2152-2154 N. 21st St., Philadelphia, Pa.**  
 European Agents: Messrs. Lee, Hurst & Co., Ltd., 100 Southwark Street, London, E. S.

# Posselt's Textile Journal

E. A. POSSELT, *Editor and Publisher*

From the standpoint of the practical information which it contains it is of value to every manufacturer, superintendent, overseer and operative, among whom it is widely circulated. It is the leading and by far the most valuable of all textile trade publications.

Special features in every issue: Discussions on Designing and Fabric Structure; Cotton, Woolen and Worsted Spinning; Silk from the Raw Fibre to the Finished Fabric; Cloth Analysis and Calculations; Dyeing and Finishing Processes; Reviews of the Market and Suggestions as to the Creation of New Styles, Color Combinations, etc.; as well as a general report on the News of the Textile Mills.

Another interesting subject this Journal contains is the serial issue of the "Dictionary of Technical Terms Relating to the Textile Industry," as appearing regularly every month, nothing of its kind being published in any language.

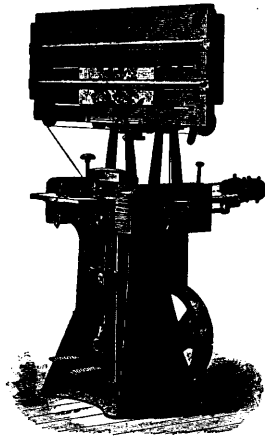
**Subscription, \$2.00 per year. Canada, \$2.50. Foreign, \$3.00**  
*Sample copies mailed upon application.*  
**POSSELT'S TEXTILE JOURNAL, Philadelphia, Pa.**



**JACQUARDS** All Types  
& Sizes  
8 to 32 Harness  
Single & Double Index **DOBBIES**  
THOS. HALTON'S SONS - Philadelphia

---

**BETTER FACILITIES**

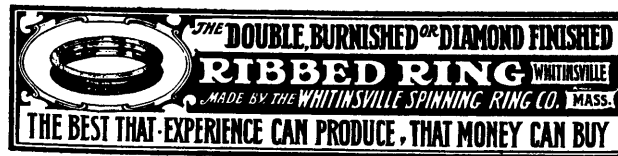


for preparing Jacquard cards  
— The Royle Card-Cutting  
Machines. Automatic move-  
ments; dependable action  
throughout.

—  
*Write for catalog*  
—

**John Royle & Sons**  
PATERSON, N. J., U. S. A.  
PIANO MACHINES, LACERS,  
REPEATERS

---



# Jno. Dunlop's Sons Quality Organzines

---

We get the finest selection of Japan silk imported by Mitsui & Co. and Morimura, Arai & Co. This gives us the first choice of over half the silk reeled in Japan. Our facilities and organization for producing the finest quality are unexcelled. We specialize in Organzine, *especially Double Extra.*

*"Merito" Chop — Double Extra*

*"Red Highlander" Chop—Extra*

*"White Highlander" Chop —  
Best No. 1 to Extra*

**Jno. Dunlop's  
Sons**

*Thrown Silk*

254 Fourth Avenue  
NEW YORK

Colt Building - - PATERSON



**HAND BOOKS OF THE TEXTILE INDUSTRY, VOL. 2**

---

**Manufacture**  
of  
**Narrow Woven Fabrics**

**RIBBONS, TRIMMINGS, EDGINGS, ETC.**

Giving

Description of the Various Yarns Used

**The Construction of Weaves**

and Novelties in Fabric Structures

Also

Descriptive Matter as to Looms, Etc.

**E. A. POSSELT**

Editor of "Posselt's Textile Journal"

---

*Over 240 Illustrations*

---

**TEXTILE PUBLISHING COMPANY**

2154 North 21st Street, Philadelphia

London, Eng.: Sampson Low, Marston & Co., Ltd

## TABLE OF CONTENTS

---

### Various Yarns Used.

Cotton Yarns .....	2
Silk Yarns .....	5
Spun or Chappé Silks .....	7
Artificial Silks .....	8
Worsted Yarns .....	9
Woolen Yarns .....	9
Linen and Jute Yarns .....	10
Ramie Yarns .....	11
Metal Threads .....	11
Rubber Strands .....	11

### Foundation Weaves.

Taffeta Weave .....	13
Twills .....	14
Satin Weaves .....	16

### Derivative Weaves.

Rib Weaves .....	18
Basket Weaves .....	20
Subdivisions of Twills .....	20
Shading of Weaves .....	26
Two Systems Warp .....	29
Face, Interior and Back Warp .....	31
Two Systems Filling .....	33
Face, Interior and Back Picks .....	34
Tubular and Double Cloth Weaves .....	35
Tubular Selvages .....	38
Full and Three-quarter Hollow Selvages .....	39
Three-quarter Hollow Selvages .....	46
Half Hollow Selvages .....	47
Rib Fabrics, With Two Systems of Filling.....	50
Hollow-cord Weaves .....	51
Weaves with Stuffer and Figuring Threads.....	56
Weaves for Double Cloth Fabrics.....	59
Piqué Weaves .....	64

*Table of Contents.*

Hollow, Double Cloth Weaves with Stuffer Picks...	65
Three and More Ply Fabrics .....	67
Connected Weaves .....	68
Figured Rib Weaves .....	70
Intersected Weaves .....	70

**Special Weaves and Effects.**

Pile Fabrics .....	71
Influence of Twist in Yarn Upon the Fabric .....	82
Entering Threads .....	87
Gauze or Leno Weaves .....	96
Ribbons Made with Open-work Stripes.....	105
Passamenterie Trimmings .....	107
Conical Shaped Ribbons .....	110
Ribbons Showing Raised Loops .....	112
Ribbons Showing Cat-stitch Effects .....	117
Bindings .....	119
Producing Figures in Smooth Ribbons.....	120
Formation of Curved Edges .....	138
Color Effects in Ribbons .....	141
Other Effects in Ribbons .....	142
Drawing-in Draft and Chain for Figured Ribbons..	143
Fringes and Pearl Edges .....	152
Lamp Wicks .....	157

**Looms and Devices.**

Looms for Narrow Woven Fabrics .....	165
Elastic Webbing Looms .....	167
Ribbon Looms .....	168
Lay of the Crompton & Knowles Ribbon Loom....	170
Take-up Rollers of the Take-up Mechanism.....	176
Shuttle-operating Mechanism .....	179
To Prolong Life of Shuttle and Shuttle-block.....	182
Another Shuttle Driving Mechanism .....	184
Take-up for Narrow Fabric Looms .....	187
Warp-Let-off for Narrow Fabric Looms .....	188
Equalizing Device for Silk Ribbons .....	192
Individual Take-up for Narrow Fabric Looms.....	194
Improvement to Take-up of Narrow Fabric Looms....	197

## **MANUFACTURE OF NARROW WOVEN FABRICS.**

### **Ribbons, Trimmings, Edgings, etc.**

Narrow woven fabrics are as much subjected to fashion as other fabrics, thousands of new designs being introduced in the market every season, hence the designer must be equally competent in his profession as the designer for men's wear, dress goods, upholstery goods, carpets, rugs, etc., is, in fact more so, since in many instances he deals with weaves and fabric structures not known by the other branches of the textile industry referred to.

The various narrow woven fabrics we come in contact with are:

Smooth Ribbons for all purposes interlaced with Taffeta-, Twill-, Satin-, Rib-, etc., weaves made from Cotton, Silk, Worsted, Linen, Ramie, etc., Yarns, used by itself or in combination with each other.

Gents' and Ladies' Hat-bands, Belts, etc.

Tube-ribbons and Tube-ties, Ribbons for Buttons.

Ribbons with Initials or Names, Badges.

Wash-ribbons, Corset and Apron-trimmings.

Embroidered-ribbons, figured in warp or filling.

Suspenders, Garters, Elastic-webbings.

Ribbons for Curtains and Point-laces.

Velvet-ribbons, Carriage-trimmings, Reins, Girdles.

Furniture-passementerie.

Upholstery-trimmings.

Ribbons for Venetian-blinds.

Ribbon-loom-embroidery.

Church-trimmings.

Dress-protectors.

Collar- and Coat-stiffenings.

Boot-straps.

Fancy-ribbons and Figured-trimmings, made of various yarns, interlaced with the greatest variety of weaves and fancy effects possible, as the constant change in fashion dictates.

### **VARIOUS YARNS USED.**

With reference to the yarns used by the industry, the same covers every possible source: Cotton, Silk, Spun or Chappe Silk, Artificial Silk, Worsted, Wool, Linen, Ramie; Metal-threads, Rubber-strands, Glass, Straw and Feathers; also partly made fabrics like Chenille, Tassels, Cords, Beads, etc.

#### **Cotton Yarns.**

On account of their low cost compared to the other yarns, they form the bulk of the yarn used in the manufacture of narrow ware. The quality of the yarn depends upon where the cotton is grown.

*Sea Island* is the best grade of cotton in the world; such as raised on its respective islands off the coast of South Carolina and Georgia, or directly on the coast, having a staple of from  $1\frac{3}{4}$  to  $2\frac{1}{2}$  inches. The fibre closely resembles silk, being extremely fine, strong and clean, permitting it to be spun readily into 150's and, if the case should require, up to 400's for ply yarn. Such of this cotton as grown further away from the coast in Georgia and South Carolina averages from  $1\frac{1}{2}$  to 2 inches in length of staple and closely resembles the actual *Sea Island* cotton, from which it is grown, permitting, if required, its spinning into 150's and up to 200's for ply yarn.

*Florida Sea Island Cotton* is grown on the mainland of Florida from *Sea Island* seed. It has a white, glossy, strong fibre, a little coarser than strict *Sea Island*, from  $1\frac{1}{4}$  to  $1\frac{3}{4}$  inches in length, and is not as carefully handled during cultivation. It is suited for lower grades of *Sea Island* yarns spun up to 150's and 200's for ply.

*Sea Island* cottons are always combed and extensively used for thread and lace making purposes; again, if dealing with special fabrics, where a very strong fibre is required in connection with heavy counts of yarns, *Sea Island* cotton is sometimes used.



Although the Sea Island is American cotton, yet this name is never used in connection with it; the name *American* meaning the typical cotton of the world grown in what is considered the mainland cotton belt; of these the Gulf (or New Orleans), Benders or Bottom Land varieties are the most important, varying as to length of staple from 1 to  $1\frac{5}{8}$  inches, permitting spinning up to 80's yarn. Cottons brought in the market as Mobile, Peelers and Allan Seed, belong to the same variety and are next in importance, while Mississippi, Louisiana, Selma, Arkansas and Memphis cottons, also belonging to this variety, are slightly inferior. Texas cotton varies from  $\frac{7}{8}$  to 1 inch in length of staple, and is suited for yarns up to 40's. Next in importance are the Uplands cotton, having a length of staple of from  $\frac{3}{4}$  to 1 inch, permitting spinning into 30's to 40's yarn.

*Egyptian Cotton* stands high in the estimation of the commercial world, the success of growing being largely due to the equability of the climate in the delta of the Nile. Of the different varieties grown there, Brown Egyptian is the best known, permitting ready combing on account of its regularities of staple. The color itself varies from dark cream to a brown tint, according to soil in which it is grown. The length of its fibre varies from  $1\frac{1}{8}$  to  $1\frac{1}{2}$  inches and is spun up to 100's yarn.

Cotton is also raised in other countries, but such does not come into consideration.

Cotton Yarns have for their standard 840 yards (equal to 1 hank) and are graded by the number of hanks 1 lb. contains. Consequently if 2 hanks, or  $2 \times 840$  yards = 1680 yards are necessary to balance 1 lb. we classify the same as number 2 cotton yarn. If 3 hanks or  $3 \times 840$ , or 2520 yards are necessary to balance 1 lb., the thread is known as number 3 cotton yarn. Continuing in this manner, always adding 840 for each successive number gives the yards the various counts or numbers of cotton yarn contain for 1 lb.

#### 4 *Manufacture of Narrow Woven Fabrics.*

Cotton Yarns are frequently manufactured into 2-ply. In such cases the number of yards required for 1 lb. is one-half the amount called for in the single thread.

*Example:* 20's cotton yarn (single) equals 16,800 yards per pound, while a 2-ply thread of 20's cotton, technically indicated as 2/20's cotton, requires only 8400 yards, or equal to the amount called for in single 10's cotton (technically represented as 10's cotton).

If the yarn be more than 2-ply, divide the number of the single yarn in the required counts by the number of ply, and the result will be the equivalent counts in a single thread.

*Example:* Three-ply 60's, or 3/60's cotton yarn, equals in size ( $60 \div 3 =$ ) single 20's cotton yarn.

In the manufacture of fancy yarns the compound thread is often composed of two or more minor threads of unequal counts.

If the compound thread is composed of two minor threads of unequal counts, divide the product of the counts of the minor threads by their sum.

*Example:* Find the equal in single yarn to a two-fold thread composed of single 40's and 60's.

$$40 \times 60 = 2400 \div 100 (40 + 60) = 24 \text{ Ans.}$$

If the compound thread is composed of three minor threads of unequal counts, compound any two of the minor threads into one, and apply the previous rule to this compound thread and the third minor thread not previously used, or: Divide one of the counts by itself, and by the others in succession, and afterwards by the sum of the quotients.

*Example:* Find equal counts in a single thread to a 3-ply yarn composed of 60's, 20's, and 15's.

$$60 \div 60 = 1$$

$$60 \div 20 = 3 \quad 60 \div 15 = 4 \text{ Ans.}$$

$$60 \div 15 = 4$$

**Silk Yarns.**

Silk is the simplest, and in its properties the highest and most perfect of all spinning materials. It differs from the other textile fibres, both as to its nature as well as the machinery used in preparing it for the loom, the machinery used being much simpler and less cumbersome than the processes employed in preparing other fibres.

It is the hardened, structureless secretion produced, in the form of thread by silk worms as a suitable covering, at the time of entering the chrysalis stage.

Silk is of two varieties: *a* True Silk, *b* Wild Silk.

TRUE, CULTIVATED OR MULBERRY SILK is the thread produced by the larva of the silk moths *Bombyx mori*.

WILD SILK is the product of one of the species of wild silk moths, found principally in India, China and Japan, and of which *Tussah* is the most important variety. It is somewhat stiff if compared to cultivated silk.

Silk yarns are graded as to their count either by the denier or the dram system, the first being generally used as applying to raw silk, the other to indicate the size of thrown silk.

*Denier System:* The length of skein adopted for basis is 450 meters and the unit of weight  $\frac{1}{2}$  decigram; thus the count is expressed by the number of  $\frac{1}{2}$  decigrams that 450 meters silk weigh.

450 meters = 492.12 yards.

1 lb. = 453.6 grams.

1 gram = 20 deniers.

1 lb. = 9072 deniers.

1 denier = 492.12 yards.

9072 deniers = 4,464,513 yards.

*Dram System:* The length of the skein adopted for basis is 1000 yards and the unit of weight 1 dram, which equals 256,000 yards per lb. The count is expressed by the number of drams (and fractions of drams) that 1000 yards weigh.

6 *Manufacture of Narrow Woven Fabrics.*

*Deniers : Drams.*

4,464,513 yards to 1 lb. in denier system  
256,000 " " 1 " " dram "

Dividing the first number by the last number gives us 17.44 deniers equal to 1 dram.

*Cocoon Basis for Count:* When dealing only with a short length of yarn, for example, a few inches of silk taken from a fabric sample and of which we have to ascertain the count, but which sample is too small, even for the most delicate pair of scales, we then must resort to practical experience, taking the original reeling of cocoons in the raw silk thread into consideration. It is usually assumed that the average of a true silk filament is about 3 deniers, hence by untwisting your thread, liberating the cocoon filaments and counting them under a magnifying glass, you then will obtain a fair idea as to the count of the yarn in question, taking into consideration that the thickness of a filament often differs materially throughout its length and that the reeler for this reason may have found it desirable to increase or decrease the number of filaments.

The usual method observed is to reel five cocoons into 13/15 denier silk.

The usual sizes into which true silk is reeled is 10/12, 12/14, 13/15, 14/16 and 16/18; finer or coarser counts may be reeled, but if so it is a rare occurrence.

The filament of the tussah wild silk is heavier, an eight cocoon tussah averaging 35/40 deniers.

The count or size of a silk yarn is always given for their gum weight, *i. e.*, the condition before boiling-off and where silk loses from 2 to 28 per cent. in its weight, according to the amount of gum, *i. e.*, sericin has to be removed from the threads, the first being known as Ecreu Silk (2 to 5%), the other as Soft Silk (up to 28%). When from 5 to 12% of the gum is removed, such silk is then known by the trade as Souple Silk.

DOPPIONE SILK is coarse and uneven, and as a rule, of a light yellow color. This silk is reeled from double

cocoons, *i. e.*, where the worms have spun their cocoons side by side, and so joined that it is necessary to reel the cocoons together, the end of neither cocoon being free without the other. The production is comparatively small, and its unevenness makes it unsuitable for a good class of work; hence its use is confined to the manufacturing of the cheapest materials where heavy counts of yarns are used.

#### **Spun or Chappe Silks.**

The product known as spun, chappe, or filoselle silk is obtained from the following classes of silk waste: (1) The coarse, loose, outer layers surrounding the true cocoon; (2) the cocoons that are defective or from which the moth has escaped, and which are therefore difficult or impossible to wind; also doubled cocoons and those from diseased larvæ (choquettes); and (3) the parchment-like skin (strusa) left behind on winding the sound cocoons.

By means of a troublesome spinning process these waste products are converted into coarse inferior yarns, the sericine being first destroyed by maceration, and the mass then washed successively with hot and cold water. When dry, the purified material is separated into fibres, more or less short, and finally converted into yarn by combing, roving, and fine spinning.

Spun silks are calculated as to the size of the thread, on the same basis as cotton (840 yards to 1 hank), the number of hanks one pound requires indicating the counts. In the calculation of cotton, woolen or worsted, double and twist yarn, the custom is to consider it as twice as heavy as single; thus double and twisted 40's (technically 2/40's) cotton, equals single 20's cotton for calculations. In the calculation of spun silk the single yarn equals the two-fold; thus single 40's and two-fold 40's require the same number of hanks (40 hanks equal 33,600 yards). The technical indication of two-fold in spun silk is also correspond-

ingly reversed if compared to cotton, wool and worsted yarn. In cotton, wool and worsted yarn the 2, indicating the two-fold, is put in front of the counts indicating the size of the thread (2/40's), while in indicating spun silk this point is reversed (40/2's), or in present example single 80's doubled to 40's.

A lower grade of spun silk is known as **BOURETTE SILK**, which is obtained from working up combings (stumba) of spun silk and the product naturally occupies the lowest position among silk yarns. It is graded the same as spun silk.

#### **Artificial Silks.**

There are three class of artifical silk met with :

(a) **COLLODION SILK** also known as *Chardonnet* silk, named after its inventor, it being the first artificial silk brought in the market.

(b) **CUPRAMMONIUM SILK**, also known as *Pauly, Linkmayer*, and more often as *Thiele* silk.

(c) **VISCOSE SILK**, also known as *Cross & Bevan*, and *Stearn* silk.

The characteristic properties of natural silk, which render it so much esteemed as a textile material, are its beautiful lustre, softness, elasticity, strength, and covering power, and the ease with which it can be dyed. With regard to lustre, the artificial silks exceed the natural fibre, some having almost an undesirable metallic lustre. In softness and general handle, most varieties of artificial silk are somewhat deficient; but this defect has recently been entirely overcome by building up the thread of a large number of fine filaments, so that a thread of 40 denier may contain 40 to 80 of such filaments. All the artificial silks are, however, somewhat difficult to manipulate in winding and in the loom.

The numbering of these artificial silk yarns is done on the same basis as true silk calculated by the legal denier (which is 450 meters = 0.05 grams) *i. e.*, 9,000 meters = 1 gram.

**Worsted Yarns.**

Worsted yarns have for their standard measure 560 yards to the hank. The number of hanks that balance one pound indicate the number or the count by which it is graded. Hence if 40 hanks each 560 yards long, weigh 1 lb. such a yarn is known as 40's worsted. If 48 hanks are required to balance 1 lb. it is known as 48's worsted. In this manner the number of yards for any size or count of worsted yarns is found by simply multiplying the number or count by 560.

Worsted yarns are frequently manufactured into 2-ply. In such cases the number of yards required for 1 lb. is one half the amount called for in the single thread.

*Example:* 32's worsted yarn (single) equals 17,920 yards per pound, while a 2-ply thread of 32's worsted, technically indicated as 2/32's worsted, requires only 8,960 yards, or the same amount called for in 16's worsted.

If the yarn be more than 2-ply, divide the number of the single yarn in the required counts by the number of ply.

*Example:* Three-ply 90's, or 3/90's worsted yarn equals in size ( $90 \div 3 =$ ) single 30's worsted yarn.

If dealing with compound threads, composed of minor threads of unequal counts, explanations given before in connection with cotton yarns refer also to worsted yarns.

**Woolen Yarns.****(a) RUN SYSTEM.**

Woolen yarns are with the exception of the mills in Philadelphia and vicinity, and parts of the West, graded by *runs* which have for their standard 1600 yards. Consequently 1 run yarn requires 1600 yards to 1 lb., 2 run yarn 3200 yards to 1 lb., etc., always adding 1600 yards for each successive run. In addi-



tion to using whole numbers only, as in the case of cotton and worsted yarn, the run is divided into halves, quarters, and occasionally into eighths, hence: 200 yards equal  $\frac{1}{8}$  run; 400 yards equal  $\frac{1}{4}$  run, and so on.

The run basis is very convenient for textile calculations by reason of the standard number equaling 100 times the number of ounces that 1 lb. contains; thus by simply multiplying the size of the yarn given in run counts by 100, and dividing the result into the number of yards given (for which we have to find the weight), gives us as the result the weight expressed in ounces.

*Example:* Find the weight of 7200 yards of 4 run yarn.

$$4 \times 100 = 400.$$

$$7200 \div 400 = 18 \text{ oz. } \textit{Ans.}$$

(b) CUT SYSTEM.

Woolen yarn is also graded by the *cut* system. 300 yards is the basis or standard; consequently, if 300 yards of a given woolen yarn weigh 1 lb., we classify it as 1 cut yarn; if 600 yards weigh 1 lb. we classify it as 2 cut yarn, and so on; hence the count of the woolen yarn expressed in the cut multiplied by 300 gives as the result the number of yards of respective yarn that 1 lb. contains.

Woolen yarn is most frequently used in single; if referring to 2 or more ply yarn of uniform, or of varying counts of minor threads, the explanation given for cotton and worsted yarns are identical.

**Linen and Jute Yarns.**

The same are graded or have for their standard 300 yards to the hank (called *lea* in connection with linen), the number of hanks that 1 lb. contains being the number of the yarn, or in other words these yarns are graded the same as woolen yarn *cut* basis. In 2 or more ply yarn the minor threads are spun cor-

respondingly finer, a 2/60's = single 30's in count; a 3/90's = single 30's in count, and so forth.

**Ramie Yarns.**

Ramie yarns were perfected and made a commercial article first in Germany, and they are using the metric system. France followed and they are using the metric system also, which is 496 yards to the pound making one number.

As to the size and the weight of hanks, that depends greatly upon what the merchandise is made for. If the linen people use it, they want a full size hank, same length and weight as they use in their linen count, *i. e.*, 300 yards to the hank and the number of hanks that weigh 1 lb. indicates the count of the yarn. On the other hand, if it is used by cotton people 54 inch hanks are used and half the size of the former.

**Metal Threads.**

Metal threads, Gold, Silver, Steel, Copper, Aluminum, etc., are used either by itself, rolled out in fine, flat ribbon-shaped strands, or thin fine threads of it are twisted with a silk or cotton thread, and they then are known as tinsel yarns.

No rules as to calculations for these yarns can be given, since the same must vary, and allowances must be permissible, since the amount of this yarn used for one yard of fabric (ribbons, trimmings, edging, etc.) will be little; the price of the goods, in which these yarns are used, will allow a fair margin.

**Rubber Strands.**

Rubber strand or Elastics are the product of the caoutchouc-tree.

The number is calculated by the section of the thread and by the number of threads that can be placed side by side to one inch. It is sold by the weight and comes in the market in strings about 66 yards long.

**The Construction of Weaves.**

Every ribbon, the same as any other woven fabric is formed with two sets of threads; Warp-threads which rest lengthwise in the fabric and Filling threads which cross the former at a right angle, the latter being inserted by the shuttle, hence commonly called picks.

The diagram designed to indicate the interlacing of warp and filling is known as the weave plan.

The paper used for the latter is known as textile designing paper or more conveniently point paper. The same has its surface crossed with numberless horizontal and vertical lines forming either squares or rectangles, depending on the texture of the fabric under consideration.

The space between any two vertical lines represents a warp-thread, that between any two horizontal lines a filling thread, and the small square, where the respective row of horizontal and vertical squares meet, is the point where it then remains for the designer to indicate which of the two systems of threads is to be up (in that spot) or down.

The design, *i. e.*, the weave is then produced by the designer painting or indicating otherwise, on every vertical space, which of the warp-threads are to be up, on the respective pick, and which are to be down, and in turn covered by the filling.

In some instances it may be found advisable to paint the design in the reverse way—in this instance a memorandum must be made on the design paper, *i. e.*, take white or empty for warp up.

Point paper is ruled to conform with the finished texture (warp-threads and picks) of the fabric to be made, for which reason point papers are ruled in an endless combination.

Point paper ruled  $8 \times 8$  or  $12 \times 12$ , etc., *i. e.* point paper ruled even, means that warp-threads and picks in the finished fabric will be equal.

Point paper ruled  $12 \times 6$  means that finished fabric is to contain twice as much warp-threads as

picks to one inch. Explanations thus given refer more particularly to large figured designs, where the latter must represent a true representation of the general appearance of the design or weave in the fabric.

For the average design on the harness loom the common  $8 \times 8$  paper is the one mostly used, no consideration to the texture of the fabric being then paid.

For convenience of counting, point paper is overlined with heavy squares, to make it easier to count the repeat of the weave.

*Example:*  $8 \times 8$  paper. 64 warp-threads repeat of weave are easily counted by taking the heavy over-ruling into consideration and when 8 heavy over-rulings indicate the repeat of the weave, whereas if paper was not over-ruled a mistake might occur, a mistake hard, if not impossible, to correct.

WEAVE means the method of interlacing warp and filling threads.

THE REPEAT of a weave comprises the smallest number of threads and picks in which the pattern is once completely contained.

#### FOUNDATION WEAVES.

There are three systems of weaves from which any weave met with is derived. The same are: Taffeta, Twills, and Satins.

##### Taffeta Weave.

Fig. 1 shows us a portion of a fabric interlaced with this taffeta weave, which in the cotton, woolen, worsted, etc., industries is known as the plain or cotton weave. It is the closest, and at the same time the most simple interlacing of warp and filling. On every pick, half the number of ends are raised, the other half forming the lower shed. In the next pick the positions of the threads in the shed are reversed, two warp-threads and two picks form one repeat of the weave. As a rule 4-harnesses are used, and when harnesses 1 and 3 are raised on one pick, and harnesses 2 and 4 or

the other pick. It will be found advisable to have harnesses 1 and 2 rise somewhat in advance of its mate harnesses, which will mix up the warp-threads in their travel from one shed to the other; they will place themselves more equally divided above and below the filling, in turn imparting to the fabric a better cover.

If dealing with a high texture in the warp and using only 2 or 4-harness, this will result in too much friction to the outside warp-threads, in turn breaking these threads more or less on account of the heavy chaffing. Using in this case 6, 8 or more harnesses will considerably remedy this breaking of the outside warp-threads, if not preventing it at all, since then a slightly narrower width of the heddles in the harness is obtained.

Fig. 2 shows in *full* type the weave for a Taffeta ribbon for 18 warp-threads. Below the weave, in *cross* type, the drawing-in draft is given, showing harnesses 1 and 2 to carry each 3 warp-threads, and harnesses 3 and 4 to carry each 6 warp-threads. The advance in raise of the harnesses (previously referred to) belongs in this instance to harnesses 3 and 4.

#### **Twills.**

Twill weaves, also called *croisè* or *serge* weaves produce in the fabric oblique, in a diagonal direction, running twill lines. On account of the less interlacing of the warp-threads and the filling, compared to the taffeta weave, they produce a looser fabric.

The lowest number of harnesses on which a twill may be designed is 4-harness, after which they can be made on any number of harness.

Twill weaves can be divided into uneven sided and even sided twills. In the first the warp or the filling predominates on the face of the cloth, whereas with even-sided twills, warp and filling show up equally if dealing with an even texture and counts of yarn.

UNEVEN SIDED TWILLS.

Fig. 3 shows two repeats, each way, of the  $\frac{1}{2}$  3-harness uneven sided twill.

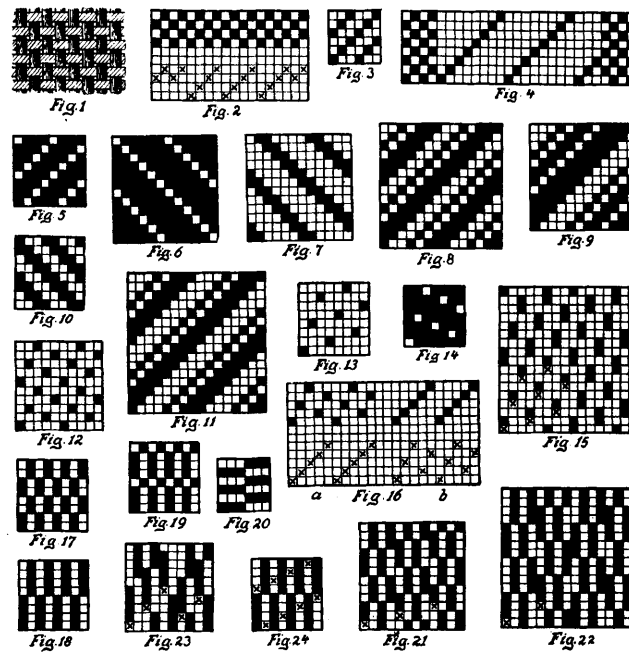


Fig. 4 shows a weave-plan for a ribbon, having for its body 19 ends,  $\frac{1}{7}$  8-harness twill and for each selvaige 4 ends taffeta. Place the harnesses which carry the selvaige threads in front, *i. e.*, next to the reed, since they have to make four changes to every one change of a twill harness, and when then, the nearer to the reed the less high said harness has to be raised, hence the less strain on the thread.

Fig. 5 is the 4-harness, uneven sided (warp effect) twill.

Fig. 6 is the 6-harness, uneven sided (warp effect) twill; direction of twill from right to left, or the reverse direction from that of the former twills given.

Fig. 7 is the  $\frac{2}{4}$  6-harness twill, twilled to the left.

Fig. 8 is the  $\frac{3}{1\frac{1}{2}}$  7-harness twill, twilled to the right, and

Fig. 9 the  $\frac{4}{1\frac{2}{1}\frac{1}{3}}$  12-harness twill.

#### EVEN SIDED TWILLS.

Fig. 10 is the 4-harness even sided twill, twilled to the left.

Fig. 11 is the  $\frac{3}{1\frac{1}{3}}$  8-harness even sided twill.

#### Satin Weaves.

The object of this system of weaves is to produce a smooth lustrous face to the fabric. To obtain this result, arrange the points of interlacing of the warp and filling so that they will be covered by the joining warp or filling floating threads, again be sure to distribute them well all over the repeat of the pattern so that no two points join. The smallest number of harness for which satin weaves can be designed is five, after which they can be made for any number but six (explained by rules given later on).

The number which tells how many warp-threads the point of interlacing must miss on every successive pick is called the *counter*, whereas the number which indicates how many picks the point of interlacing raises on the next warp-thread is called the *grade*.

In order to obtain the number for the *counter* or for the *grade*, divide the number of the repeat of the satin you want to construct in two parts under the following conditions:

- (a) neither part can be 1.
- (b) neither can they be equal.
- (c) neither can they be equally divisible between each other.



(*d*) they must not be divisible equally by a third (1 excluded) number.

Either one of the pair of numerals thus obtained can then be used either for *counter* or for the *grade*.

*Example:* 8-harness, the following pairs of numbers can be made.

1 and 7 — no good — see rule *a*

2 and 6 — no good — see rule *c*

3 and 5 can be used

4 and 4 — no good — see rule *b*

This will give us numerals 3 and 5, either one of which can be used as *counter* or *grade* numeral for obtaining the 8-harness satin.

It must be mentioned that when one of the numbers of the pair thus obtained is used as *counter*, the other is not always the *grade* number in that example.

Fig. 12 is the 5-harness (filling effect) satin, two repeats each way are given.

No regular satin can be designed for 6-harness, according to conditions *a*, *b*, *c* and *d* previously quoted. To obtain an irregular 6-harness satin, divide the points of interlacing of the weave so that the filling taken successively calls in turn for the 1st., 3rd., 5th., 2nd., 6th., and 4th., warp-thread.

Fig. 13 is the 8-harness (filling effect) satin, one repeat only being given.

Fig. 14 is the 7-harness (warp effect) satin, one repeat only being given.

#### DOUBLE SATINS.

are obtained from our regular satins by adding one (or more) additional point of interlacing to the original satin spot, placing the same either on top or on bottom or in an oblique direction to the original spot.

Fig. 15 shows two repeats each way of the 5-harness double satin. In the left hand lower corner, the foundation is shown by *cross* type.

If with a satin chain, a few warp-threads in the fabric have to weave twill, then draw said warp-threads in the harness with a satin draw and the result will be twill in the fabric.

In the same way, if with a plain chain a few warp-threads have to weave satin, then draw the latter threads with a satin draft in the harness.

Fig. 16 explains the subject. *Full* type shows harness chain, *dot* type shows draft; the result in both instances is the same in the fabric—the 5-harness satin; or in other words:

The 5-harness satin as chain, with a straight draw (see diagram *a*) = 5-harness satin in fabric.

The 5-harness satin as chain, with a satin draw = 5-harness twill in fabric.

The 5-harness twill as chain, with a straight draw = 5-harness twill in fabric, and

The 5-harness twill as chain, with a satin draw (see diagram *b*) = 5-harness satin in the fabric. The same also refers to any other regular satin than five.

## DERIVATIVE WEAVES.

### Rib Weaves.

The same have for their foundation the taffeta weave, their characteristic rib lines running either warp or filling ways; hence they are known either as warp or filling ribs.

In connection with warp ribs, the warp forms the face and back of the fabric, the filling resting imbedded between the warp-threads; the rib-lines running in the fabric in the direction of the filling.

With filling ribs, the affair is reversed, the filling then forms face and back of the fabric and the warp rests imbedded between the filling; the rib lines run in this case warp ways in the fabric.

Fig. 17 is the  $\frac{2}{2}$ , 2 by 4 warp effect, rib weave.

Fig. 18 is the  $\frac{4}{4}$ , 2 by 8 warp effect, rib weave.

Fig. 19 is the  $\frac{3}{1}$ , 2 by 4 warp effect, rib weave.

Fig. 20 is the  $\frac{3-3}{3}$ , 6 by 2 filling effect, rib weave.

Fig. 21 is the  $\frac{3-3}{3}$ , warp effect rib weave, transposed with four warp-threads in a set, after the 3-harness twill for motive (see *cross* type). Repeat of weave 12 by 6.

Fig. 22 is the  $\frac{4-4}{4}$ , warp effect rib weave, transposed with four warp-threads in a set, two picks higher (see *cross* type), repeat 8 by 8.

Fig. 23 is the  $\frac{5-5}{5}$ , warp effect rib weave, transposed with two warp-threads in a set after the 5-harness satin (see *cross* type) for its motive. Repeat of weave 10 by 10.

Fig. 24 shows how to strengthen a too loosely interlacing rib weave; the weave used being  $\frac{4-4}{4}$ , 2 by 8 rib weave warp effect, the strengthening of the cloth being done with the  $\frac{1-3}{3}$  4-harness uneven sided twill (see *cross* type). This procedure, however, results in what we technically term a one side fabric.

#### STRENGTHENING THE STRUCTURE BY MEANS OF AN EXTRA WARP OR FILLING.

Provided the fabric has to present face and back to be the same, the interlacing of the warp-threads (while floating on the back) into the structure, in order to impart strength and body to the fabric, is not permissible. Resources then must be taken to an extra warp, interlacing the same with a closely intersecting weave; the plain weave is the one most generally used. This extra warp is then placed in combination with the regular rib weaving warp in a proportion to suit texture of the fabric, the more of these plain weaving warp-threads there are used, the stiffer the resulting fabric structure. The most often met with combinations are:

4 ends rib : 1 end plain.

6 ends rib : 1 end plain.

Weave Fig. 25 explains the subject, showing the  $\frac{6-6}{6}$  warp rib weave (see *full* type) strengthened with a plain weaving thread (see *cross* type) every

six warp-threads; repeat of weave 14 by 12. This plain weaving thread is not visible on the face nor the back of the fabric—it rests in the body of the structure.

If dealing with filling effect rib weaves, an extra pick (binder-pick) interlacing closely, like for example the plain weave, is then inserted after every four or six (or any other combination) rib picks.

Weave Fig. 26 illustrates the subject showing six picks rib weave (see *full* type) to alternate with one pick plain weave (see *cross* type); repeat of weave 12 by 14. The same as in the previously given example in connection with a binder warp, the binder pick in the present example is neither seen on the face or the back of the fabric.

Strengthening the fabric structure by means of a binder warp is the plan most often met with. Two warp-beams are then required in the loom, on account of the difference in the take-up of both warps, *vis*: one beam for carrying the rib warp and a second beam for the binder warp; the latter will take up more at the weaving compared to the rib warp.

#### **Basket Weaves.**

The same are, from a theoretical point of weave formation, the combination of mate, warp and filling effect, rib weaves. The same as with filling rib weaves, two or more warp-threads are drawn on one harness, previous to drafting onto the next harness; in the same way two or more picks are inserted in one shed previously to changing on the other shed.

Two examples are given, *vis*:

Fig. 27 the  $\frac{2}{2}$  4 by 4 plain basket weave, and

Fig. 28 the  $\frac{2}{2}$  4  $\frac{2}{2}$  14 by 14 basket weave.

#### **Subdivisions of Twills.**

New weaves are obtained from our foundation twills by distributing warp or filling threads after a given arrangement. Results obtained can be again distributed by the same, or another arrangement, in this way resulting in an endless variety of new weaves.

For the ribbon industry the following subdivisions of twills come under consideration :

(A) BROKEN TWILLS.

*Rule:* Run a given number of warp-threads of your foundation twill in one direction, arrange a *break*; reverse drafting for a certain number of warp-threads and arrange again a *break*. Continue this procedure for the required number of drafts in both directions until the repeat for the new weave is obtained.

By the *break* of the weave, previously referred to, we mean "skip half the number of harness of your foundation twill, minus one".

Fig. 29 shows us two repeats each way of the 4-harness broken twill, filling effect, having for its foundation the  $\frac{1}{3}$  4-harness twill, the latter being drawn for two threads from left to right, break, two threads drawn reverse, break, and repeat.

$4 \div 2 = 2 - 1 = 1 =$  skip *one* harness for your break, *i. e.*, draft your broken twill from your foundation twill thus: 1, 2, 4, 3. Repeat 4 by 4.

Fig. 30 is what we consider a fancy broken twill, having for its foundation the  $\frac{3}{1} \frac{1}{3} \frac{1}{1}$  10-harness twill, given in Fig. *a*, produced by what we must consider an imperfect break. The drafting done is: take three warp-threads and break, and continue this until repeat is obtained.

The break used in this instance is not a perfect break as could have been done by skipping ( $10 \div 2 = 5 - 1 =$ ) 4 warp-threads when drafting the broken twill from the foundation twill, or skipping 4-harness whenever reversing drawing-in after drawing three warp-threads in one or the other direction.

Using foundation twill *a* for the harness chain, will give us drawing-in draft for weave Fig. 30 thus: 1, 2, 3—6, 5, 4—7, 8, 9—2, 1, 10—3, 4, 5—8, 7, 6—9, 10, 1—4, 3, 2—5, 6, 7—10, 9, 8. Repeat of weave: 30 by 10.

*(B) POINTED TWILLS.*

This subdivision of twill weaves differs from those previously referred to, in that the drafting of the foundation twill in either direction is done without missing any warp-threads in drafting the weave (or skipping harnesses in drawing-in the warp-threads) when reversing the twill in either direction. This gives us one thread or harness to be known as the point thread or point harness, which can be claimed by either direction of twill, hence must be deducted when considering repeat of weave. The next two examples will explain subject.

Fig. 31 has for its foundation the 4-harness uneven sided twill, warp effect, drafted for 4 warp-threads (alternately) in either direction.

$4 + 4 = 8 - 2$  (points) = 6 warp-threads and 4 picks, repeat of weave.

Fig. 32 has for its foundation the  $\frac{3-1}{1-1}$  6-harness twill, drafted respectively for 6, 4, 4 and 6 ends = 20 ends — 4 (points) = 16 warp-threads and 6 picks; repeat of weave.

*(C) COMBINATION BROKEN TWILLS.*

The same refers to combining the two mate (warp and filling) effect twills. Since this refers to two different weaves, or to two impure even sided weaves as we might say, no reduction in harnesses takes place, each foundation twill requiring its own set of harnesses.

Weave Fig. 33 explains subject.

Foundation weaves:  $\frac{3-1}{1-3}$  and  $\frac{1-3}{3-1}$  8-harness twills.

Draft each weave for 6 warp-threads, one twill in one direction, the other the reverse, having a clear break between these twills. Repeat of weave 12 by 6.

*(D) SKIP TWILLS.*

The same have for their foundation pure even sided twills, like the  $\frac{2}{2}$  or  $\frac{3}{3}$  or  $\frac{1-1}{2-2}$ , etc., twills.

*Rule:* Run foundation twill for a given number of warp-threads and arrange break; continue this until

repeat of new weave is obtained. Break means the same as explained in connection with broken twills, *viz.*: skip one half the number of warp-threads or harnesses of the foundation twill, less 1.

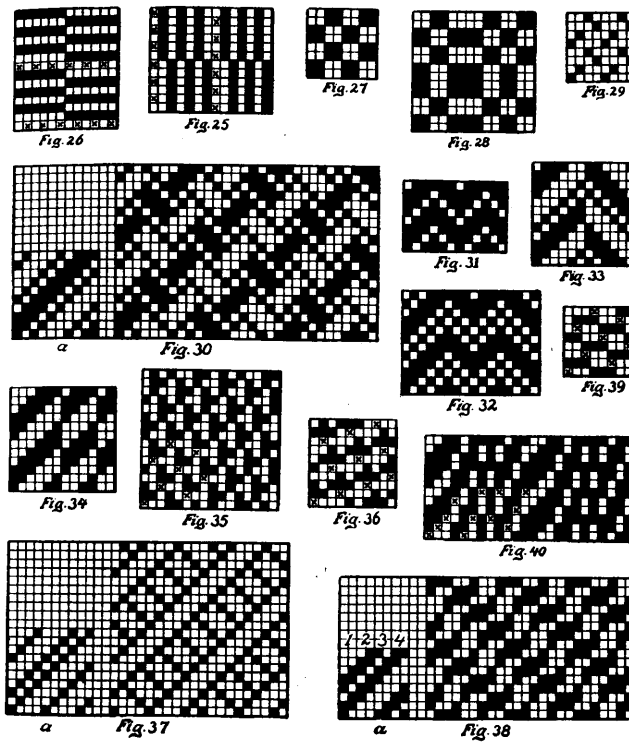


Fig. 34 shows us a skip twill having for its foundation the 6-harness even sided twill, drafted in sections of 6, 4 and 2 warp-threads respectively. Repeat of weave 12 by 6; can be drawn on 6-harness if so desired.



24 *Manufacture of Narrow Woven Fabrics.*

(E) GRANITE WEAVES OBTAINED BY SATIN-DRAFTS FROM TWILLS.

In their construction, twills are distributed after a satin motive. Another way to obtain the same result is to plan the satin weave (filling-effect) first, and add to each spot the interlacing of one repeat of the foundation twill. Weaves Figs. 35 and 36 will explain subject.

Fig. 35, *cross* type shows the 8-harness satin, filling effect. To each of these spots we added on top of it 2 risers, 1 sinker, 1 riser, 3 sinkers, obtaining in this way one of our most frequently met with granite weaves.

Another way of obtaining this same granite weave is to use the  $\frac{3}{1} \frac{1}{3}$  8-harness twill for harness chain in connection with an 8-harness satin for drawing-in draft, hence the name satin-draft twills. Repeat of weave: 8 by 8.

Fig. 36 *cross* type shows 10-harness satin, filling effect. To each of these spots we added on top of it 2 risers, 1 sinker, 1 riser, 3 sinkers, 1 riser, 1 sinker, obtaining another good granite weave. Its foundation twill to be used with its proper satin draft is the  $\frac{3}{1} \frac{1}{3} \frac{1}{1}$  10-harness twill. Repeat of weave: 10 by 10.

(F) FANCY TWILLS OBTAINED FROM REGULAR TWILLS BY SATIN DRAWS.

Weave Fig. 37 explains subject, the same having for its foundation the  $\frac{1}{1} \frac{1}{3} \frac{1}{3}$  10-harness twill (shown at *a*) drafted after the 10-harness satin-draw thus: 1, 8, 3, 10, 5, 2, 7, 4, 9, 6. Repeat of weave: 10 by 10.

(G) FANCY TWILLS OBTAINED BY SECTION DRAWING.

Weave Fig. 38 explains subject. *a* is the foundation twill, the  $\frac{2}{1} \frac{2}{3}$  8-harness twill. The same is divided in 4 sets of 2 threads each, *vis*:

Set 1: warp-threads 1 and 2  
 " 2: " " 3 " 4  
 " 3: " " 5 " 6  
 " 4: " " 7 " 8

as indicated by numerals of references on top of foundation twill.

Starting drafting with set 4 first, set 3 next, set 2 next, and closing with set 1 gives us weave Fig. 38, repeating on 8 by 8, a most often met with weave in practical work.

(H) OBTAINING GRANITE-WEAVES FROM FANCY TWILLS.

Dividing one repeat of weave Fig. 38 filling ways in four sets of two picks each (starting from the bottom of weave Fig. 38) will give us:

Picks 1 and 2 = Set 1  
 " 3 " 4 = " 2  
 " 5 " 6 = " 3  
 " 7 " 8 = " 4

Starting to construct the new weave beginning at the bottom with set 4, and follow it up with sets 3, 2 and 1 in rotation, in turn will give us weave Fig. 39.

The latter weave may also be considered as a granite, *cross* type showing the 8-harness satin foundation, to which are added above and to the right hand to each satin spot three risers (see *full* type). Repeat of weave 8 by 8.

(I) CURVED TWILLS.

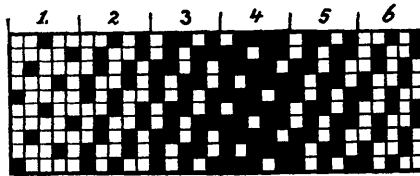
The same are a combination of regular, *i. e.*, 45 deg. twills in combination with steep twills of 63, 70, etc., deg. grading, imparting in turn to the fabric the curved twill effect.

Weave Fig. 40 explains the subject, showing a curved twill having for its foundation the  $\frac{4}{2}$  6-harness twill, drafted (see *cross* type) alternately 3 ends each of 45, 63, 70 and 63 deg. twill. Repeat of weave 12 by 6.

**Shading of Weaves.**

For this purpose either twills or satins are employed, the latter being the ones most often used.

To produce a shaded weave, paint its foundation weave, filling effect, all over the desired repeat of the new weave combination, after which separate the latter into the required number of divisions, to suit the scope of the foundation weave as well as the value of shading desired.

*Fig. 41*

If using a foundation of a large repeat (for example the 8-harness satin) we can produce a more delicate shading as compared to one of a smaller repeat (for example the 5-harness satin) since the former presents more possible changes from its filling to its warp effect (7 to 4 in the two examples quoted).

Either all possible changes of the foundation weave may be called upon, and what is most often the case, again one or more of these possible changes may be omitted. Using every possible change at our disposal, will result in the most gradual shading possible produced, whereas omitting a change will make the shading correspondingly more abrupt, a feature which however in some instances may be desired.

Having divided the repeat of the weave plan with the foundation weave (filling effect) inserted into the required number of divisions, leave your first division as it is. In the next division add, either warp or filling ways, one riser to each original riser of the foundation weave. Add in the same way two risers

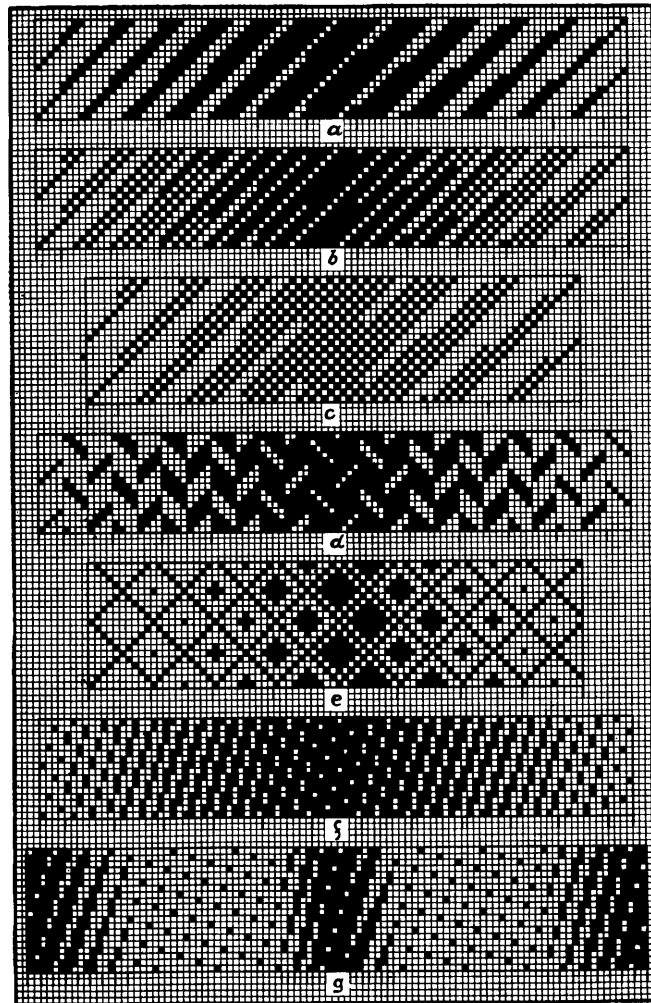
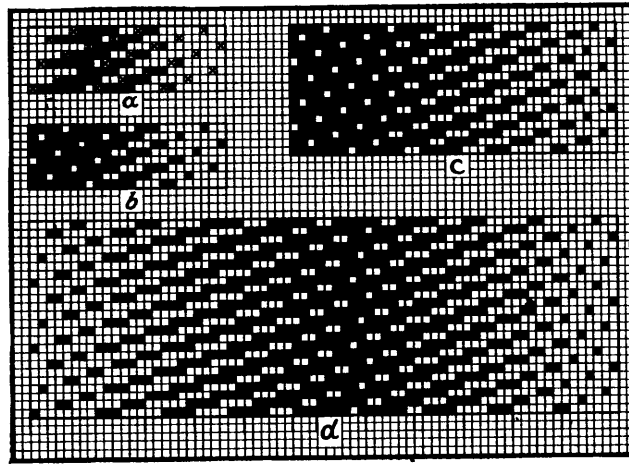


Fig. 41\*

to the original foundation riser in the third division, and proceed similarly, adding one additional riser in each division until finally obtaining the warp effect, and when then, provided a shading back is desired, the reverse procedure (subtract one riser) is observed with every successive division, until returning to the original filling effect of the foundation weave.



*Fig. 41\*\**

Weave Fig. 41 explains subject, using the 5-harness satin for the foundation weave. Above this weave plan we find the latter divided into six divisions of 5 warp-threads each, hence repeat of shaded weave to be  $(6 \times 5 =) 30$  warp-threads.

- 1 shows foundation weave (filling effect).
- 2 “ add one riser to foundation.
- 3 “ add two risers to foundation.
- 4 “ add three risers to foundation (warp effect).
- 5 “ add only two risers to foundation.
- 6 “ add only one riser to foundation.

In the same way as we thus treated the 5-harness satin, any other satin or twill can be dealt with.

Collections of shaded weaves Fig. 41\* and Fig. 41\*\* are given to illustrate subject, and when in connection with the first collection of weaves,

*a* shows twill shading in stripes, using the 8-harness twill for basis, with 8 warp-threads for every possible change from filling to warp effect and vice versa.

*b* shows another method of shading of the 8-harness twill.

*c* shows the shading of the 10-harness twill to a plain weave, and vice versa.

*d* shows twill shading in stripes, using the 8-harness broken twill for basis, in connection with seven changes, each extending for 8 warp-threads.

*e* shows twill shading in stripes, using the 10-harness pointed twill for the basis of the new weave, with 10 warp-threads for each effect.

*f* and *g* show different values of satin shading; *f* has the 8 and *g* the 10-harness satin for its basis.

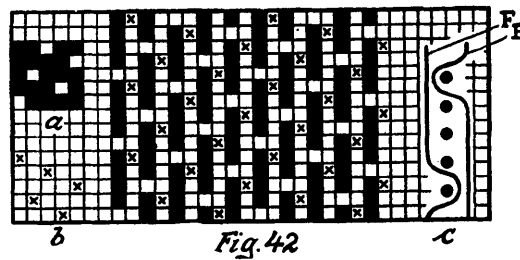
Satin weaves can also be shaded by adding the additional spot or spots as until now placed on top to the foundation satin riser, either to the right or left of the latter. Collection of weaves Fig. 41\*\* explain subject, all having the 8-harness satin for their basis. *a* shows the planning for *b*, the foundation satin being shown in *cross* type; *c* shows an enlargement of effect *b*, and *d* shading in both directions.

#### Two Systems Warp.

In this instance a face warp and a back warp is used in connection with one system of filling in the construction of the fabric, the latter interlacing with both systems of warp-threads. These weaves find use in connection with double faced ribbons, coat and shoe straps, etc. Any warp effect satin, twill, etc., may be used for face, its mate or any other filling effect weave being used for interlacing the back warp.

The interlacing of the two systems of warp with

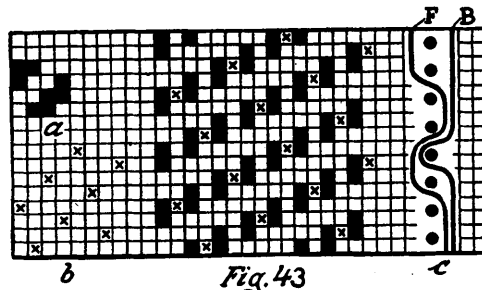
the filling must be so arranged that the same is not noticeable on either side of the fabric. For this reason place the sinkers of the face warp so that every one



*Fig. 42*

comes between two sinkers of the back warp, and vice versa place your risers of the back warp so every one comes between two risers of the face warp.

Weaves Figs. 42, 43 and 44 are given to illustrate subject. In all three examples the face warp is shown by *black* type, and the back warp by *cross* type.



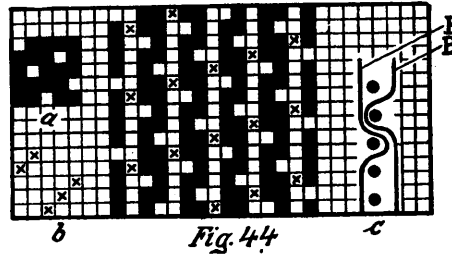
*Fig. 43*

Fig. 42 shows a weave where each side of the fabric will show 5-harness satin, warp face. Diagram *a* shows the weave used for interlacing the face warp-threads and *b* the weave for interlacing the back warp-threads. Diagram *c* shows a section of the fabric, the latter being cut warp ways: *F* indicates the face warp, *B* indicates the back warp, and *circles* the sections of the filling.

Fig. 43 shows a weave in which the face warp interlaces with the 4-harness even sided twill, and the back warp with the 8-harness satin.

The arrangement of Face warp: Back warp, in weaves Figs. 42 and 43 is 1:1, or balanced; this arrangement however, is not always used.

Fig. 44 gives us an example where said proportion is 2 ends Face warp to alternate with 1 end Back



warp. The weave used for the face is the 5-harness satin, warp effect, and that for the back the 5-harness filling effect twill.

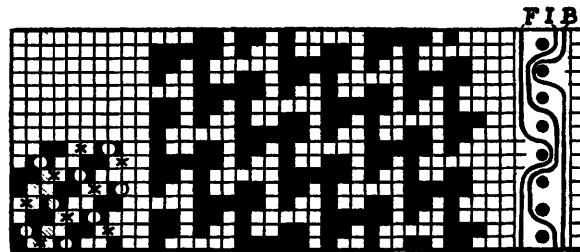
In both weaves, Figs. 43 and 44, letters of reference as well as kind of type used, correspond to those used and explained in connection with weave Fig. 42.

**Face, Interior and Back Warp.**

In fabrics constructed with these 3 systems of warp quoted (and one system of filling) the face and back warps only show, the interior warp (as its name indicates) resting in the interior, *i. e.*, the centre of the fabric; in some instances the latter may be also used for producing figures, either on the face or the back of the fabric. One set of filling only is used. When planning these weaves, remember that the interlacing of face warp-threads (sinkers) is done between two interior warp-threads which tie down (sinkers) on the same pick; again the rising of the back warp-threads



must be done between two interior warp-threads raised on the same pick. The weaves most suitable for the



*Fig. 45*

interlacing of the interior warp-threads are even sided weaves.

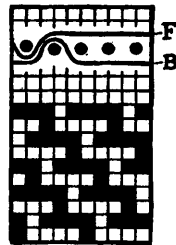
Previously to laying out a weave of this kind, put your interior weave on a piece of point paper and ascertain whether the sinkers of the face warp and the risers of the back warp suit, *i. e.*, will combine, after rule previously referred to, with said interior warp. If such is the case, care must be exercised when planning the final 3-warp weave, that the positioning (relation) of the face and back warp-threads to that of the interior warp-threads remains the same as in the plan previously experimented with.

Fig. 45 shows such a weave with 8-harness satin for face and back warp, and 4-harness even sided twill for the interior warp. In the experimental plan shown at the left of weave, *cross* on the line means sinker for face warp, and *circle* on the line means riser for back warp.

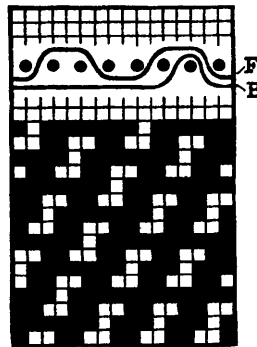
At the right hand side of the weave the interlacing of one end each of face, interior and back warp is given, in connection with eight picks. *F* in said fabric-section indicates the face warp, *I* the interior, and *B* the back warp threads.

**Two Systems Filling.**

In connection with weaves constructed with a face and a back filling (in connection with one system of warp) neither system of filling should show on its reverse side. This will result if observing in the construction of these weaves the following rule:



*Fig. 46*



*Fig. 47*

In the back picks only such warp-threads can be lowered which are down in the preceding and the following face pick.

In the face picks only such warp-threads can be raised which are also raised, on the preceding and the next following back pick.

Fig. 46 shows such a weave with 5-harness satin for the interlacing of face and back filling.

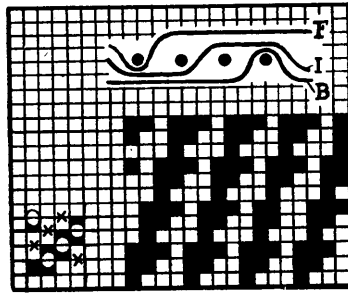
Fig. 47 shows a weave with 4-harness even sided twill for the interlacing of the face filling, and 8-harness satin for the interlacing of the back filling.

Above weaves Figs. 46 and 47, a section of each respective fabric structure is given, showing face and back filling marked respectively *F* and *B*, the section of the warp threads (one repeat of weave) being shown by *circles*.

**Face, Interior and Back Picks.**

In this instance, on the face of the fabric, the face pick only shall be seen, and on the back of the fabric the back pick only, the interior pick being introduced into the structure solely to increase the bulk of the latter and is neither visible on its face nor its back.

For warp-threads to be raised at the face pick select such threads as are up on the interior pick preceding and following said face pick, whereas in connection with the back pick, sinkers of the warp then used must be down on the interior pick preceding and following said back pick.



*Fig. 48*

Fig. 48 shows us such a weave, having the  $\frac{1-3}{3}$  4-harness twill for face picks, the 4-harness even sided twill for the interior picks and the  $\frac{3-1}{1}$  4-harness twill for the back picks.

Above the weave a section of the fabric structure as interlaced with this weave is given, showing one pick each of face (F) back (B) and interior (I) filling.

In the experimental plan given at the left of the weave, a *cross* indicates warp-threads down at back picks; and *circle* warp-threads up at face picks.

**Tubular and Double Cloth Weaves.**

By means of these weaves two independent fabrics (one above the other) are constructed in the loom. According to the way of entering the filling, respectively in the upper and the lower fabric structure, the two structures are either not at all connected with each other, or they are connected with each other either at one or both edges.

Two independent fabrics, minus connections, are obtained if using a separate shuttle for each ply of the fabric, an arrangement which however is seldom (if ever) used in connection with narrow ware fabrics.

Using only one shuttle in connection with a double cloth structure, arranged one pick face to alternate with one pick back, the result will be that the two plies are connected at their edges, *i. e.*, a hollow, tubular fabric is formed.

Using one shuttle in connection with double cloth, arranged two picks face: two picks back, will result in a fabric connected only at one edge, the other edge, showing the two independent plies (double edge gal-lons, double edge velour edgings).

The warp-threads, in connection with these weaves are divided into such as will interlace only either in the face or in the back ply.

When planning for the construction of these weaves, be sure that all back warp-threads are down when interlacing the face ply, since if threads of the lower ply would then be raised, both plies would be united into one fabric.

On the face picks (light picks, since then the least warp-threads are raised) only such risers, *i. e.*, face warp-threads up, are marked as refer to the weave of the face ply only, face warp-threads not raised resting inside of the tubular fabric structure. All warp-threads of the back ply are down on these face picks.

### 36 *Manufacture of Narrow Woven Fabrics.*

On the back picks (heavy picks, since then the greater portion of the warp-threads are raised) lift every face warp-thread, since otherwise the face ply would interlace into the back ply. Next indicate the risers for the back structure for said pick, *i. e.*, such of the interlacings of warp-threads as in the structure rest in the inside of the tubular fabric. The raised face ply warp-threads and the lowered back ply warp-threads form the outside of the tubular fabric structure.

If constructing a tubular or double cloth weave which shall show on its outside (on face and back) the  $\frac{3}{1}$  4-harness twill, the face warp-threads must then be raised on three successive face picks and lowered on one face pick, whereas the back warp-threads must be lowered on three successive back picks and raised on the next back pick.

When planning tubular or double cloth weaves, indicate on your weave plan which are the face and which the back warp-threads and picks, after which:

- (1) raise all face warp-threads on all back picks.
- (2) plain weave for the face fabric on face picks, considering face warp-threads only; all back warp-threads are left down.
- (3) plain weave for back ply on the back picks, considering back warp-threads only; all face warp-threads are raised.

If using a stuffer warp, for the interior of a tubular structure, the same must be raised on all back picks and lowered on all face picks.

To illustrate subject, weave plans Figs. 49, 50, 51 and 52 are given; no selvages are taken into consideration, they being dealt with later on in connection with the articles on tubular selvages and tubular cords.

In connection with weaves Figs. 49, 50, 51 and 52, the face warp-threads and the face picks are indicated

respectively at the bottom and at the side of the weave by means of a *dash*. In the left hand lower corner of each illustration one repeat of the weave is shown executed in different types, to illustrate the building up of the double cloth structure, and where *cross* type represents the interlacing of the face warp (*up*) in the face picks. *Diamond* type in the weave indicates the interlacing of the back warp (*up*) in the back picks. *Dot* type in the weave indicates the raising of all the face warp on every back pick.

Weave Fig. 49 shows the placing of two plain woven fabrics, one above the other. Above said weave is given a diagram of the positioning of the warp-threads in connection with one face (*F*) and one back (*B*) pick.

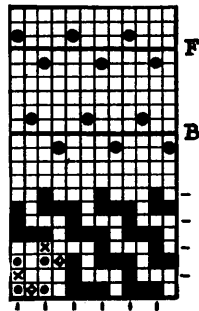


Fig. 49

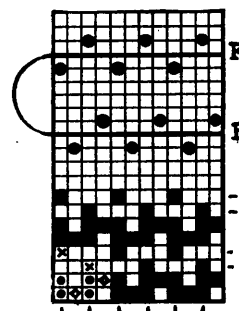


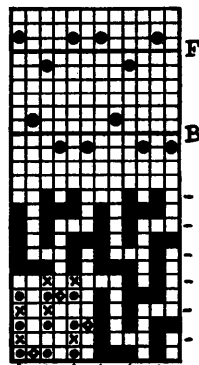
Fig. 50

Fig. 50 shows us a double plain weave, arranged 2 picks face to alternate with 2 picks back, showing in the section of the fabric, as given above the weave, the connection of the two fabrics on one side; *i. e.*, the filling, after interlacing with the plain weave for 2 picks in one of the plies, then passes for 2 picks, plain weave, in the other ply.

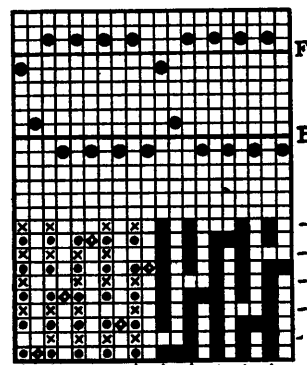
Fig. 51 shows us a tubular fabric interlaced with 3-harness twill, and Fig. 52 a tubular fabric interlaced with 5-harness satin.

**Tubular Selvages.**

The same play a most important part in the manufacture of ribbons and appear either as full, half or three-quarter tubular selvages.



*Fig. 51*



*Fig. 52*

FULL TUBULAR SELVAGES contain a separate face and back structure (face and back warp and filling), both having the same number of warp-threads.

HALF TUBULAR SELVAGES are such as contain a face and a back filling, but only one system of warp, and which interlaces with the face filling, the back filling floating, *i. e.*, is not interlacing with the warp-threads.

THREE-QUARTER TUBULAR SELVAGES have a face and back warp and filling; however, the face carries in this case more selvage threads. The term three-quarter is only taken to indicate the difference between full and half tubular selvages, it has nothing to do with the proportion of face and back selvage threads used, and which vary according to character of fabric structure under consideration.

For double face ribbons as well as the better class of one face structures, full hollow selvages are mostly used, the other two kinds of selvages referring more particularly to the medium and cheaper grades of one faced structures.

**Full and Three-quarter Hollow Selvages.**

The weaves used for these selvages belong to the class described before under Tubular and Double Cloth Weaves. In addition to directions then given, be careful that a perfect edge (no curling up) of the selvage is produced by the filling traveling from one ply into the other.

When planning the draft for such a fabric be sure to indicate on the point paper the entering of the first pick into the structure, *i. e.*, whether said pick enters the shed at the left or at the right, and after this trace the run of the filling throughout the repeat of the weave.

The filling traveling on every two picks from one ply into the other is the cause of connecting the face and back selvage structures. These two picks, successively following each other, are known as a *return pick*. Severing the hollow selvage, next to the structure lengthwise in the fabric, and opening out the same so as to represent a single cloth structure, such a return pick will then show as one pick. Provided the shuttle enters the shed at the left, the first return pick for the right hand selvage then will be picks 1 and 2, the second return picks, picks 3 and 4 and so on. At the same time the first return pick for the left hand selvage then will be picks 2 and 3, the second return pick, picks 4 and 5, etc. Changing the entering of the shuttle will naturally also change the number of the two picks as form a return pick. Having obtained a clear understanding of this return pick, remember that when planning the weave, these return picks must form perfect single cloth if opened out as before explained. How to proceed, will be best explained in connection with a practical example.

Suppose a hollow selvage showing 3-harness warp effect twill is required. After indicating on your point



paper face and back warp-threads and picks, as well as return picks, raise first all the face warp-threads on every back pick. The method of interlacing of the 3-harness twill (warp effect) is *2 up 1 down* and what we change in the present instance to *2 out 1 in*. Following this formula, insert the weave for the face structure in plan mapped out previously on the point paper; next insert the weave in the back ply, being careful that the formula in the back pick, as forming with the face pick together a return pick, connects properly to the respective face pick, remembering at the same time that *2 out* in connection with the back pick, means the lowering of 2 back warp-threads and *1 in* the raising of a back warp-thread, since in the lower ply the *down* of the back warp-threads forms the face of the fabric.

Any number of warp-threads can be used for these selvages, the number to use depending upon the character of the fabric under consideration.

The accompanying four diagrams Fig. 53 *A, B, C* and *D*, illustrate sections of differently interlaced hollow selvages and their plans of interlacing if severed from the fabric and turned flat, as we previously referred to.

The face warp-threads are shown in full black circles.

The back warp-threads are shown in shaded circles.

*a* to *b* = face pick.

*b* to *c* = back pick.

Diagram *A* shows a perfectly interlacing return pick in connection with interlacing face and back structure with the plain weave (see *b* in flat diagram).

Diagram *B* shows the same weave used in connection with an imperfectly interlacing return pick (see *b* in flat diagram, showing 2 warp-threads up, *i. e.*, interlacing the same).

Diagram *C* shows a perfectly interlacing return pick in connection with the 3-harness twill warp effect (see *b* in flat diagram), whereas

Diagram *D* shows an imperfectly interlacing return pick (see *b* in flat diagram, showing 4 warp-threads up, side by side, in place of 2, the formula of the 3-harness twill).

If dealing with Jacquard work, it will be found advisable to balance the interlacing of the two selvages of the fabric with reference to face and back pick,

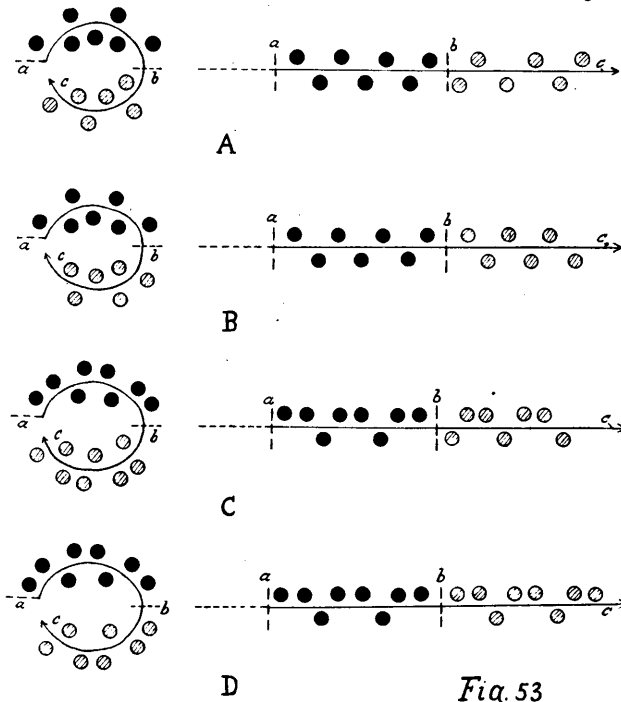
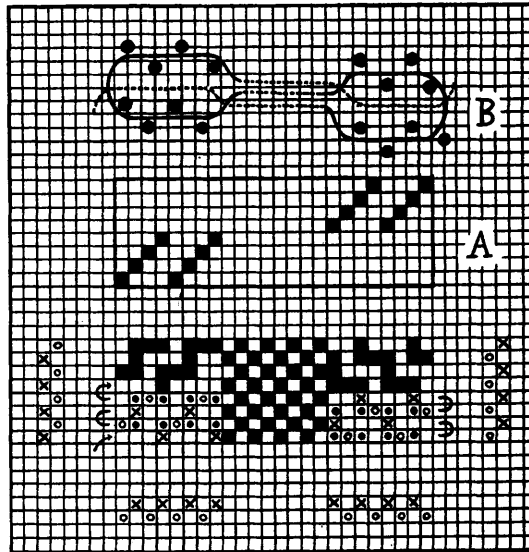


Fig. 53

*i. e.*, when one of the selvages interlaces back pick, plan in your design that the other weaves face pick, and vice versa. In connection with harness work, to reduce the number of harnesses required, this feature is, as a rule, not made use of.

Stuffer warp threads, inserted into these hollow selvages, so as not to show on either side of the fabric, must be raised on every back pick and lowered on every face pick.

Diagrams Figs. 54, 55, 56, 57, 58 and 59 show six examples of these hollow selvaige weaves. The centre of the ribbon is shown in Fig. 54, but is omitted (shown black) in the other five diagrams.



*Fig. 54*

Fig. 54 shows a weave plan for a hollow selvaige, plain face and back, reverse working.

x = face warp and filling.

o = back warp and filling.

Centre of ribbon = common plain weave, *i. e.*, taffeta weave.

Selvaige requires 8 harnesses, *i. e.*, four harnesses for each side (see Diagram *A*), no attention being

taken to the centre of the ribbon, and for which 4 or any other multiple of 2 harnesses, additional, are required.

*B* shows diagrammatically the interlacing of one return pick from both selvages.

Combining a hollow selvage with taffeta, *i. e.*, plain weave for centre of ribbon, see that the first

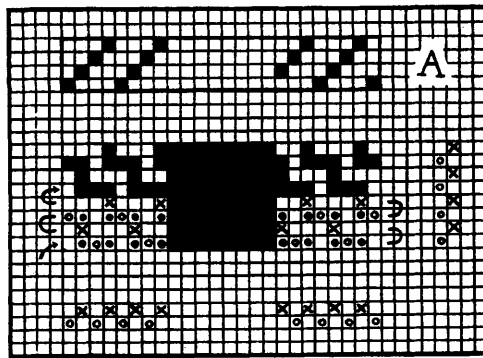


Fig. 55

taffeta thread next to the selvage, raises on the face pick of the latter, and is down on the back pick of the latter; the reverse being the cause of it simply acting as a stuffer for the selvage.

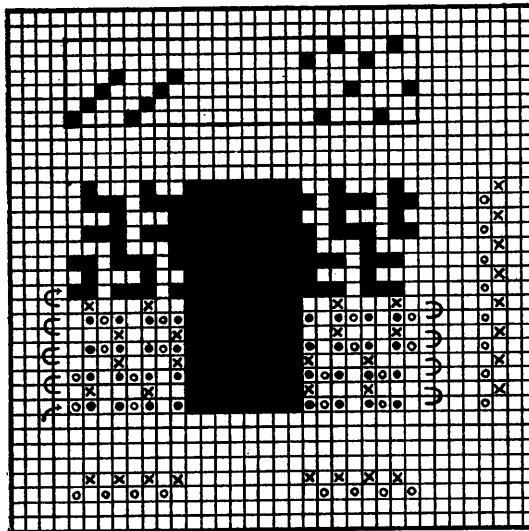
Diagram Fig. 55 shows a similar hollow selvage as the one just explained, only that in this case selvages are working face and back pick alike, requiring only four harnesses for their execution (see Diagram *A*).

Fig. 56 shows us a hollow selvage produced with the 2 by 4 warp rib weave, *i. e.*, 2 picks in a shed of the plain weave.

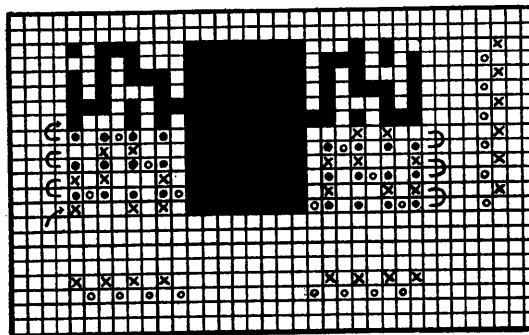
Fig. 57 is a hollow selvage with 3-harness twill, warp effect, for both sides of the selvage.

Fig. 58 shows us a hollow selvage with 5-harness satin, warp effect, for both sides of the selvage, showing also the application of stuffer warp-threads.

Selvage threads and stuffer warp-threads are shown



*Fig. 56*



*Fig. 57*

in fabric section *A*, showing two return picks in connection with it.

Fig. 59 illustrates a hollow selvage with a 4-harness

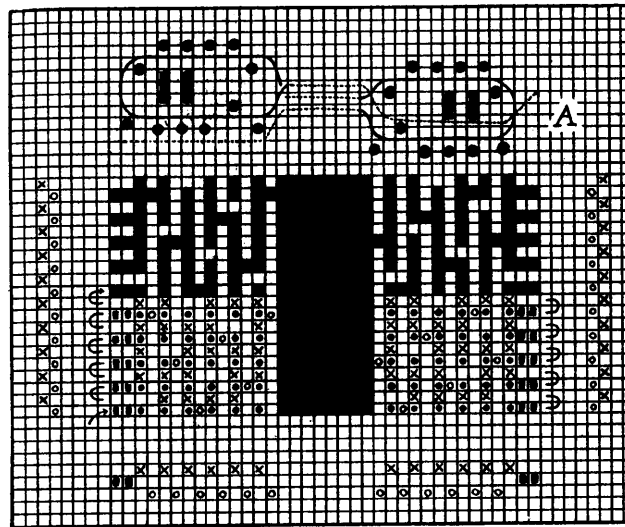


Fig. 58

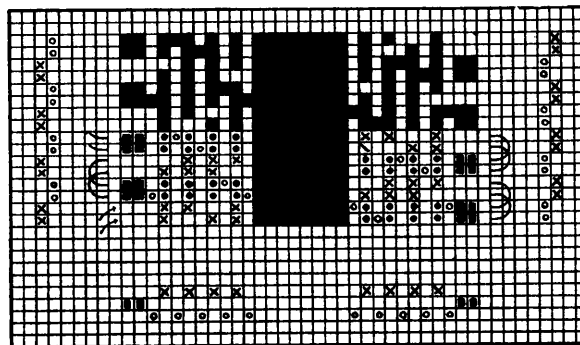


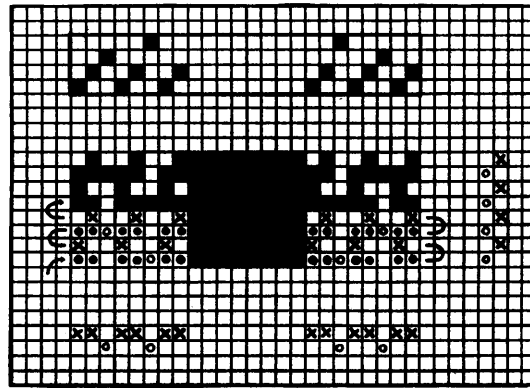
Fig. 59

broken twill, warp effect, for face and back, designed for using 2 shuttles; each shuttle successively interlac-

ing once in one ply then in the other ply. If using the arrangement of one face to alternate with one back, the threads as coming from one of the shuttles would cross only in the face warp, the other in the back warp, obtaining no hollow selvage but a double selvage minus interlacing face and back ply.

**Three-quarter Hollow Selvages.**

The same are worked similar as the complete hollow selvages. It must be remembered that the outside warp-thread of the back warp connects properly with the outside warp-thread of the face warp, since the same are not always drawn-in side by side, as is the case in connection with the construction of complete hollow selvages. Diagram Fig. 60, shows us such a

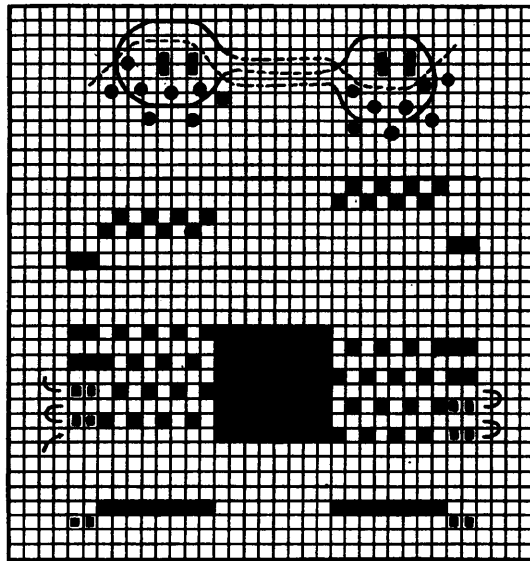


*Fig.60*

three-quarter hollow selvage, requiring four harnesses for its execution on the loom. Below the weave is given the scheme for the warp, at the right hand side, the scheme for the filling, and above the weave, the drawing-in draft.

**Half Hollow Selvages.**

These selvages contain two systems of filling and one system of warp; the latter interlaces only with



*Fig. 61*

one of these systems of filling, the other floating respectively, either on the face or the back of the structure, in the loom, according to whether the fabric is weaving face or back up. As will be readily understood, in the finished fabric, the floating picks of the filling rest on the back of the structure.

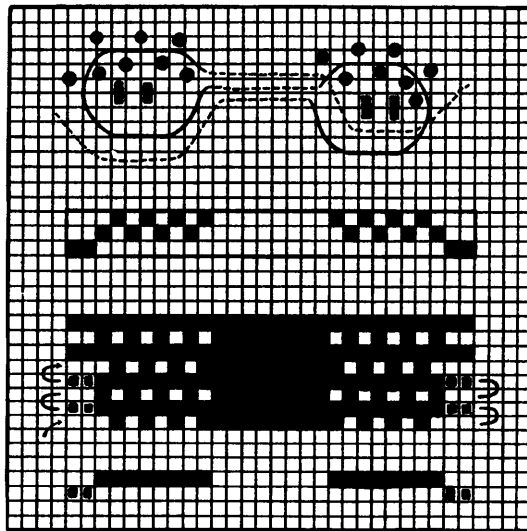
If using a rather tight tension on the filling, the outside warp-thread will be drawn somewhat towards the back of the structure.

Fig. 61 is the weave for such a half hollow selvedge, calling for six harnesses; viz: four harnesses for the face warp and two harnesses for the stuffer warp (using one harness for the left, and one harness for



the right hand selvage). Considering *full squares* for risers, the weave is given with face down (cut *empty squares*, if face up in the loom is desired).

Below the weave is indicated the scheme for the warp, *viz*: 2 ends stuffer, 8 ends face warp, for left



*Fig. 62*

hand selvage, and the reverse arrangement for the right hand selvage.

Above the weave is given the drawing-in draft—for six harnesses, and above the latter, a diagrammatical section of the fabric structure.

Fig. 62 shows us another weave for such half hollow selvage. The plain weave is used again for interlacing every other pick, both selvages either interlacing or floating the filling on the same pick, with the result of using only two harnesses, where the arrangement in the preceding weave, called for four harnesses.

In the same way are the stuffer warp-threads interlaced, with one harness in place of the two harnesses called for in the preceding weave. The scheme for the warp, drawing-in draft and diagrammatical fabric section are also given. *Full* squares for warp up, show face up in the loom.

Fig. 63 shows us another weave for such a half hollow selvage. The interlacing is, in this instance, done with the 3-harness twill. The filling either interlaces or floats simultaneously on both selvages, hence only three harnesses are required for both selvages, plus one harness for the stuffer warp. The scheme for the warp, drawing-in draft and diagrammatical fabric section are also given. *Full* squares for risers show

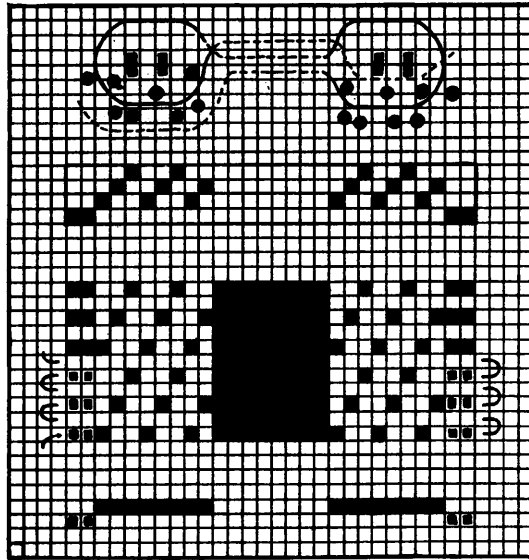


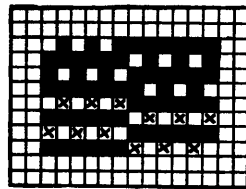
Fig. 63

face down in the loom, hence take *empty* squares for warp up, *i. e.*, risers, to have face of fabric up in loom.

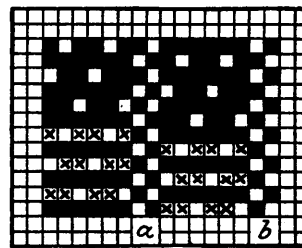
**Rib Fabrics, Formed With Two Systems of Filling.**

This system of weaves is extensively used for the body portion of narrow ware fabrics, and closely resembles in their construction the half hollow selvages previously explained.

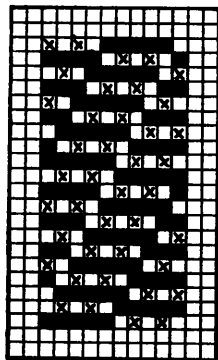
Two picks of any one of these weaves always act as companion picks, *i. e.*, when one of them, for a



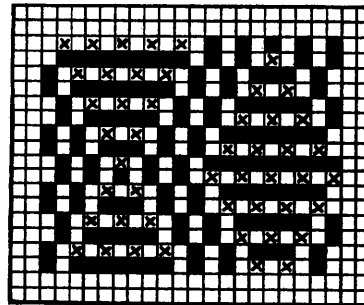
*Fig. 64*



*Fig. 66*



*Fig. 65*



*Fig. 67*

certain number of warp-threads, interlaces as face pick, the other floats on the back of the structure, and vice versa.

This exchanging of the picks results (at the places where the same occurs) in indentations in the fabric structure, which, if so desired, may be made more pronounced by having two or three warp-threads interlace at these places as single cloth in the fabric.

Four weaves are given to explain the subject. In the same, *cross* type indicates the interlacing of the filling with the warp as a face pick.

*Cross* type and *full* type indicates warp up, *i. e.*, the floating pick rests on the back of the fabric structure.

Weave Fig. 64 shows the plain weave (see *cross* type) used for the interlacing of the face of the fabric structure. The cut lines in the fabric run with the direction of the warp. Two repeats of the weave filling ways are given.

Weave Fig. 65 shows again the plain weave (see *cross* type) used for the interlacing of the face of the fabric structure, the cut lines in the fabric in this instance being arranged to run in an oblique direction.

Weave Fig. 66 shows the 3-harness twill, warp effect, used for the interlacing of the face of the fabric structure. In order to increase the *cut* effect in the fabric, we used in this instance two series of warp threads (see *a, b*) in the repeat of the weave to interlace in single cloth, *i. e.*, the pure, plain weave in this instance.

Weave Fig. 67 shows a figured effect, showing again the plain weave used for interlacing the rib-fabric structure as figured (diamond pattern) upon by a single cloth warp rib effect ground.

#### Hollow-cord Weaves.

In connection with fabrics interlaced with these weaves, the filling intersects alternately in the lower and then in the upper fabric structure. The filling, in passing at the edges from one structure into the other, is the only connection made in uniting the two structures into one fabric.

The weave for the warp threads must be carefully planned to correspond to the insertion of the filling, *i. e.*, the back pick must connect perfectly onto the preceding face pick on one edge of the fabric, and vice versa, the face pick onto the back pick on the

other edge of the fabric; for which reason the side from which the shuttle is to be entered, must be taken into consideration by the designer when planning a new weave and be correspondingly marked on the weave plan for reference by the weaver. For instance, in connection with satin cords, the filling must interlace with the face and back warp so that in the woven fabric it is impossible to distinguish face from back structure.

This feature makes it not possible for the designer to use any number of warp threads, but, he must according to weave to be used and the entering of the shuttle (whether this is done from the left or the right) first ascertain the *foundation number* for the respective weave, adding to the latter any number of repeats of the weave, to suit texture and width of fabric to be made. This *foundation number* is the lowest number of warp-threads possible to be used in the formation of a hollow-cord, in which the weave runs out perfectly in the filling.

If severing such a hollow-cord fabric in the direction of the warp, *i. e.*, cutting the filling, such a structure, if then opened out flat, must present a perfect single cloth structure. Treating the fabric in this way, every pick then consists of one face and one back pick of the original double cloth structure—appearing in the single cloth structure as if inserted all in one direction, *i. e.*, either from left to right or from right to left. This characteristic position of the filling in turn serves for the ascertaining of our *foundation number* previously referred to.

To obtain the latter by theory, paint one repeat of the single weave you intend to use and indicate on the point paper from which side the first pick is to be entered. This single weave consider now as the fabric obtained by cutting the hollow-cord structure as before referred to, *i. e.*, that the picks are all entered from one side. If considering the entering of the filling by the first edge from the left, the interlacing of the

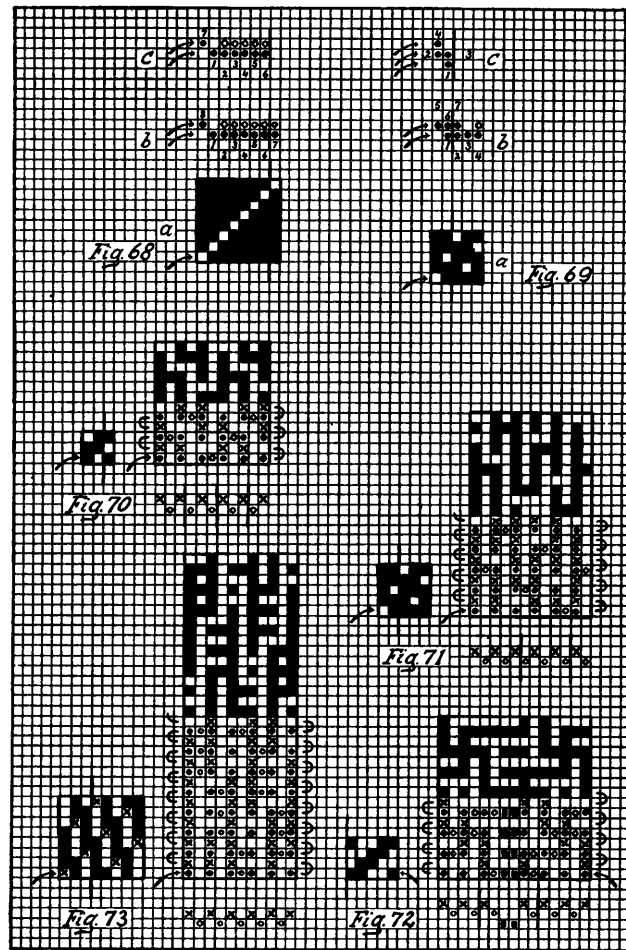
next pick must then connect from the left onto the right hand side of the preceding pick. If, however, considering the entering of the pick from the right hand side, then the interlacing of the next pick must connect from right onto the left hand side of the preceding pick. Add to the repeat, or take away from it, as many warp-threads as necessary, until a proper connection is obtained; the number of warp threads of one repeat thus required is the *foundation number* previously referred to.

Fig. 68<sup>a</sup> illustrates one repeat of the single weave, the 8-harness satin, warp effect, interlacing 7 *up* 1 *down*; *i. e.*, after one end down, seven warp threads are raised. Considering pick 1 (entering the pick from the left) shows us warp thread 1 down, and warp threads 2 to and inclusive 8, raised. In the second pick, warp thread 1 is up and warp thread 2 is down. Considering then the down of both picks (see Fig. 68<sup>b</sup>) shows us 8 warp threads up (7 on pick 1 and 1 on pick 2—both shown in black circles) in place of the required standard 7, or one too many. To remedy this trouble, strike off one warp thread from the single weave (see Fig. 68<sup>c</sup>), and when the *foundation number* then is  $(8 - 1 = 7)$  seven.

If, however, considering the entering of the filling from the right hand side, we then find only 6 warp threads up between the two sinkers and when consequently one warp thread must be added to the repeat of the weave. The foundation number then is  $(8 + 1 = 9)$  nine.

Fig. 69 shows us the 5-harness satin, warp effect, used as the single weave. The interlacing of this weave is 4 *up* 1 *down*. Considering the entering of the filling to be done from the left, we then find if reading from the first to the second sinker, 7 risers in the place of 4 (see Fig. 69<sup>b</sup>). For this reason, we then have to cross off three warp threads from the repeat of the weave, obtaining in this manner the foundation number  $(5 - 3 = 2)$  two.

However, if entering the filling from the right hand side, the foundation number then would be three.



The most often used arrangement of face and back is 1: 1, although others may be called upon.

Fig. 70 is a hollow-cord weave interlacing with the 3-harness twill. The foundation number is 2. The design shows three repeats of the single weave plus the foundation number ( $3 \times 3 + 2 = 11$  ends). The weave formation for the single 3-harness twill is *2 up 1 down*, for the double cloth weave *2 outside 1 inside*.

Considering the first pick of the weave (back pick from left to right) shows the first two back warp threads outside (down); the third, inside (high); the next two back warp threads outside (down).

With the second pick (face pick from right to left) the first face warp thread must (from the right) consequently rest inside (down), the two next outside (up), the fourth face warp thread inside (down) etc.

Filling ways, build up the weave as explained in the chapter on hollow selvages (*i. e.*, double cloth, minus stitching).

In connection with complete weave, Figs. 70, 71, 72 and 73, *empty* squares indicate sinkers, all others, risers.

Fig. 71 shows us a 5-harness, warp effect satin, hollow-cord weave, showing two repeats, plus the foundation number ( $2 \times 5 + 2 = 12$  ends). The weave plan, *4 outside 1 inside*, is then (according to the insertion of the picks) on the back pick placed in the back warp threads and at the face picks in the face warp threads. Provided the correct foundation number is obtained, the satin weave will then connect properly.

Fig. 72 shows us a hollow-cord weave, interlacing with the 4-harness even sided twill, having stuffer ends in the centre.

Fig. 73 is a hollow-cord weave, showing the *5 up 3 down* 8-harness  $70^\circ$  steep twill. One repeat plus the foundation number ( $8 + 3 = 11$  ends) is given. The filling interlaces after the following formulæ: *2 up 1 down 2 up 1 down 1 up 1 down* and which, considering the fabric structure, means: *2 outside 1 in-*

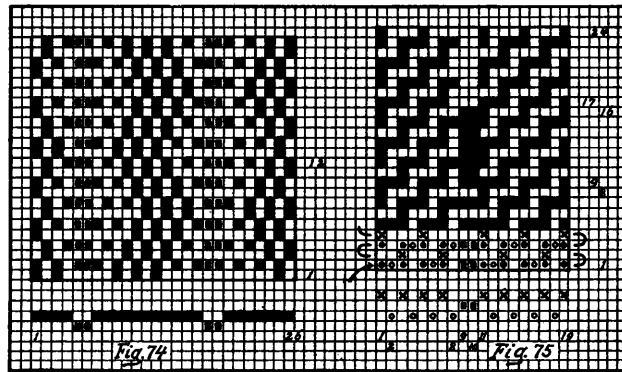


*side 2 outside 1 inside 1 outside 1 inside*; this arrangement is then indicated onto the warp threads.

Not every weave can be as successfully used as a hollow-cord weave, for instance, no perfect edge can be designed in connection with the warp effect rib weave.

**Weaves with Stuffer and Figuring Threads.**

In these fabrics the stuffer warp-threads rest, *i. e.*, float between face and back structure not visible on either side of the fabric, being for this reason raised on every back pick and lowered on every face pick.



If said stuffer warp-threads at the same time are also used for the purpose of figuring on the face or the face and back of the fabric, they then must be raised on the respective face picks when required to be seen on the face of the fabric, and lowered on the respective back picks when required to show on the back of the fabric structure.

Fig. 74 shows us a specimen of a weave of this class, showing two sets of 2 stuffer warp-threads each, in one repeat of the weave, floating between face and back picks throughout the entire repeat of said weave.

These stuffer warp-threads refer to threads 5, 6 and 18 and 19 of our weave, being shown in *heavy dot* type so as to contrast with the balance of the weave as is shown in *full* type, the complete weave repeating on 26 warp-threads and 12 picks; two repeats filling ways of the weave are given. The arrangement of the warp-threads, as shown by gamut below the weave is thus:

4	ends	regular
2	"	stuffer
11	"	regular
2	"	stuffer
7	"	regular

—  
26 warp-threads in repeat of pattern.

Weave. Fig. 75 shows us in an otherwise double plain fabric structure in which 2 extra warp-threads are used part of the time as a stuffer warp, or floating, *i. e.*, figuring on face or on the back of the fabric structure.

Examining our weave in detail we find

Warp-threads 1 to 8 = double plain.

" " 9 and 10 the 2 extra warp-threads  
previously referred to.

" " 11 to 19 = double plain.

With reference to the double plain portions, its construction is shown in the first 4 picks in different type to illustrate the rules of constructing double cloth, viz.:

*Dot type* = Raise every face warp-thread on every back pick.

*Cross type* = Insert face weave (the plain weave in this instance) on every face pick, considering the face warp-threads only for this purpose.

*Circle type* = Insert weave for back structure (again the plain weave in this instance) on every back pick, considering the back warp-threads for this purpose only, in turn obtaining the regular double plain, minus stitching, *i. e.*, two separate fabric structures,

united on their sides, or selvages, by means of the filling passing from one structure into the other, as clearly shown in the weave and where the filling enters (see arrow at left of pick 1) in the back structure. Leaving the latter (see starting of connecting bow line at the right hand of the first pick) it then enters in the formation of the second shed, *i. e.*, pick 2 and which is a face pick. This connects the two fabric structures. The shuttle upon leaving pick 2 (see bow line at the left hand side of the weave) then enters pick 3, or a back pick, in turn connecting the two fabric structures on this side. After this the affair is similarly repeated, over and over again, throughout the entire repeat of the weave.

With reference to warp-threads 9 and 10 and which are the characteristic features of this system of weave formation, the same are shown at:

Picks 1 to 8 to act as a stuffer warp, *i. e.*, rest between face and back filling. In the first four picks they are shown by *heavy dot* type, after that the same as the rest of the weave by uniformly *full* type.

Picks 9 to 16 show these two warp-threads to float (*i. e.*, figure) for eight picks on the face of the fabric structure.

Picks 17 to 24 show the reverse effect, produced by these two warp-threads, *i. e.*, they are made then to float for eight picks on the back of the fabric structure.

This clearly explains the three possible positions for these figuring warp-threads:

- (1) stuffer = not visible on face or back of fabric structure.
- (2) figuring, by showing on the face of the fabric structure.
- (3) figuring, by not showing on the face of the fabric structure, *i. e.*, floating on the back.

Repeat of weave Fig. 75 is 19 warp-threads and 24 picks.

Below the weave the gamut (scale) for the disposition of the warp-threads is given thus:

1 end face, <i>cross</i> type	}	× 4
1 " back, <i>circle</i> type		
2 ends figure warp, <i>heavy dot</i> type		
1 end face, <i>cross</i> type	}	× 4
1 " back, <i>circle</i> type		
1 end face <i>cross</i> type, to produce a uniform appearance of two edges to the fabric.		

#### Weaves for Double Cloth Fabrics.

##### STITCHING BOTH STRUCTURES.

Three different ways are at our disposal for accomplishing this, *viz.*:

- (1) Using a special binder warp,
- (2) Stitch back warp to face filling,
- (3) Stitch face warp to back filling.

##### (1) USING A SPECIAL BINDER WARP.

This arrangement is extensively used in connection with Suspender Webs, Horse Reins, etc. By it, the narrow-ware fabric, by means of two warp-threads weaving single cloth, is subdivided into a series of hollow ridges or tubes, *i. e.*, hose-structures, running side by side of each other warp ways in the web, and which hollow tubes are, as a rule, filled with rubber strands and stuffer warp-threads.

The weave used for these two ends, interlacing in single cloth, is either the plain (*taffeta*) or more frequently the 2 by 4 rib weave, warp effect.

Fig. 76 shows us such a suspender weave, interlaced with taffeta.

The arrangement of warp-threads used in the dressing of the warp is thus:

- 2 ends, warp rib (warp-threads 1 and 2, see *cross* type), *i. e.*, single cloth,
- 3 ends, face warp (warp-threads 3, 4 and 5, see *full* type)
- 1 end, back warp (warp-thread 6, see *dot* type)
- 1 end, rubber (warp-thread 7, see *rectangle* type)



- 1 end, stuffer warp (warp-thread 8, see *circle* type)
- 1 end, back warp (warp-thread 9, see *dot* type) and
- 3 ends, face warp (warp-threads 10, 11 and 12, see *full* type).

---

12 ends, in repeat of pattern.

The rubber and the stuffer warp-threads (7 and 8) rest in the tube weaving portion of the fabric.

This repeat of the pattern is duplicated as often as required by the width of the suspender web to be made (2 repeats only are given in our example) closing the web on the right hand side with 2 ends rib weave, *i. e.*, single cloth, the same as it was started on the left hand side of the web.

Fig. 77 shows us a suspender weave using the 3-harness twill, warp effect, for the interlacing of face and back warp.

The arrangement of warp-threads used in the gamut is:

- 2 ends, warp rib, single cloth (*cross* type)
- 3 ends, face warp (*full* type)
- 2 ends, back warp (*dot* type)
- 1 end, rubber warp (*rectangle* type)
- 1 end, stuffer warp (*circle* type)
- 3 ends, face warp (*full* type)
- 2 ends, back warp (*dot* type)

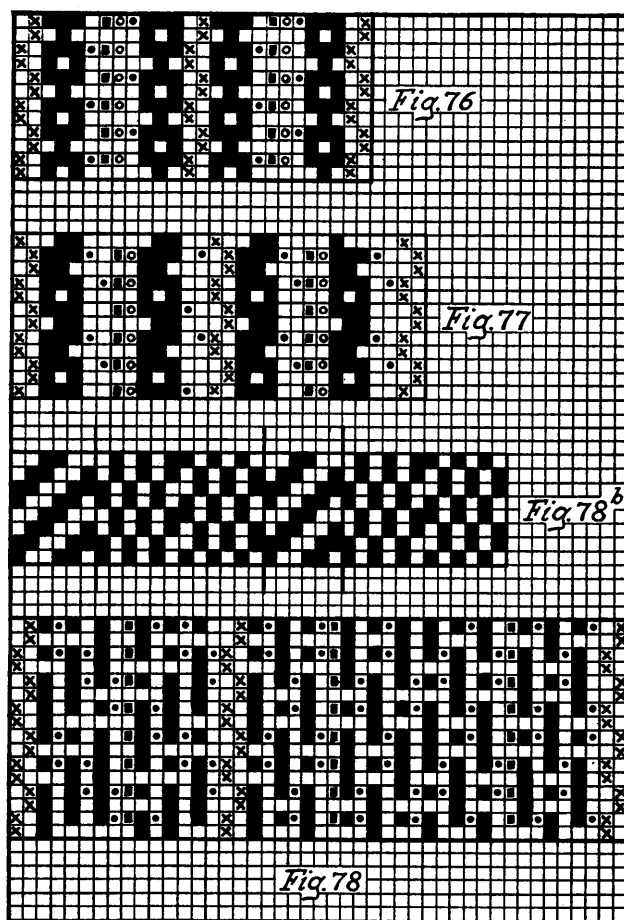
---

14 ends, in repeat of pattern.

Two repeats of this pattern, plus the 2 ends single cloth which form the selvage on right hand side of web are given in the weave plan. The number of repeats of the patterns to use depends on the width of the fabric made.

Fig. 78 shows us a weave for horse reins, arranged with one end face (see *full* type) to alternate with one end back (see *dot* type) warp and filling ways,

in the double cloth tube sections of the fabric, using also a stuffer warp (see *rectangle* type). Warp rib,



*i. e.*, two ends single cloth (see *cross* type) are used for uniting the double cloth structures in one fabric.

Fig. 78<sup>b</sup> shows two repeats of the face weave (the same being used for both sides) of the fabric, the heavy lines, extending above and below the weave, indicating where the two warp-threads weaving single cloth (2 by 4 warp rib), produce cut lines in the fabric structure.

(2) STITCHING BACK WARP INTO FACE FILLING.

*Rule:* Raise the back warp-thread on the face pick when the joining face warp-threads (the face warp-thread on either side, next to the back warp-thread thus raised) are in the upper shed, in order that said face ends will cover the stitch. At the same time arrange the back weave so that a riser precedes and follows the stitch, that is, provided the back weave has two successively following risers. If there are only individual risers in the back weave, have the same either precede or follow the stitch. This will result in an easier handling of the warp by the loom and at the same time, the fabric will present a smoother face.

The accompanying two examples will explain the subject:

Fig. 79. In the same *a* shows the weave for the face and *b* the weave for the back structure. *c* is the double cloth weave and *d* a corresponding section of the fabric structure, cut between the first and second warp thread of weave *c*.

In the latter diagram

*Black* type indicates the weave for the face structure,

*Dot* type: Raise every face warp thread on every backing pick.

*Cross* type shows the weave for the back structure.

*Circle* type shows the stitching of the back warp onto the face filling (Risers).

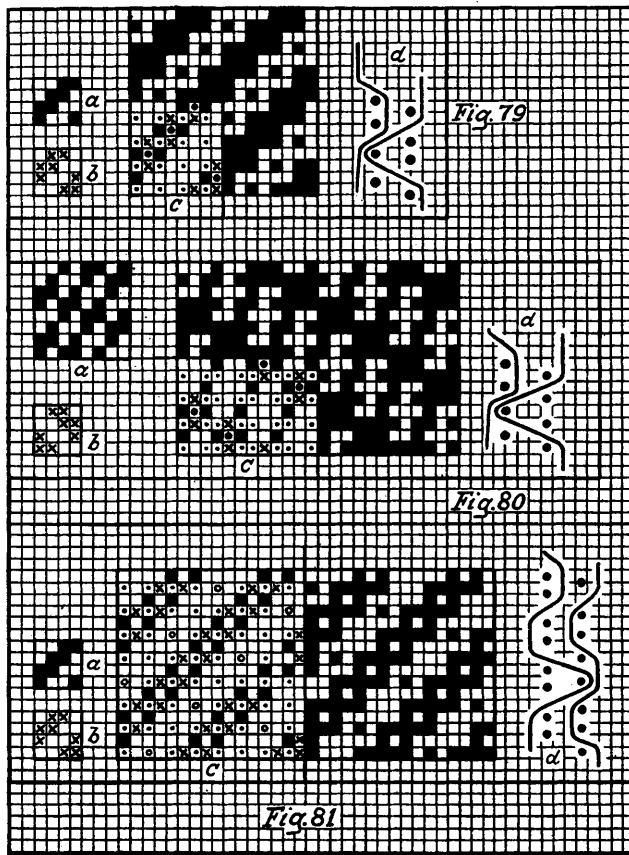
*Arrangement* of Face and Back, in Warp and Filling, is 1 : 1.

*Weave* for Face and Back is the 4-harness even sided twill.



Stitch: The 1 up 3 down, 4-harness twill.

Repeat of Weave: 8 warp threads and 8 picks.



One repeat is shown in the different kinds of crochet type quoted before, the other three repeats are shown in one kind of type.

Fig. 80 shows us another example of this class of

weaves. Letters of references and style of crochet type used correspond to those as used in the preceding example, hence will explain the subject without any further comment on it, the only difference being, that in the present instance, the arrangement of face to back warp is 2 : 1, that of the face and back filling being again 1 : 1.

Repeat of weave *c* is 12 warp threads and 8 picks.

### (3) STITCHING THE FACE WARP INTO THE BACK FILLING.

*Rule:* Lower the face warp thread on the back pick when the joining back warp threads are also in the lower shed, at the same time, arrange said stitch between the two sinkers of the joining two face picks, *i. e.*, that three sinkers show in rotation lengthways in the double cloth weave.

Fig. 81 explains the subject.

Letters of references and style of crochet type used, correspond again to those used in the two preceding examples, the only difference being that *circle* type (the stitch) in this instance stands for *sinkers*, having used for this reason an outlined circle.

*The weave* used for the stitching is the 8-harness satin, filling effect.

*Arrangement* of Face to Back in warp and filling is 1 : 1.

*Repeat* of weave *c* is 16 warp threads and 16 picks. Two repeats of the weave are given, one in a selection of crochet type to show the construction of said double cloth weave, the other repeat being given in one kind of type.

### **Piqué Weaves.**

In the construction of fabrics interlaced with these weaves we use a face and a back warp. The first, as a rule, interlaces with *taffeta* (plain weave) and comes with a light tension from one warp beam, whereas the back warp comes heavily weighted from another warp

beam and is made to rest in the fabric structure for several picks without interlacing with the filling. It interlaces only at certain spots with the face structure, for which reason the latter, on account of the less tension on its warp, forms itself embossed (raised) over the back warp.

Weave Fig. 82 shows such a piqué weave; in the same the back warp is stitched onto the face cloth in the shape of an oblique square.

Weave Fig. 83 shows us a piqué weave in which the stitching of the back warp into the face cloth forms cross stripes, it being a weave frequently met with in the manufacture of ribbons.

Crochet type used in the one repeat showing construction of weave Fig. 82 indicates thus:

*Full* type = the weave for the face structure,  
*Dot* type = raise every face warp thread on every backing pick,  
*Cross* type = the weave for the back structure, and  
*Circle* type = stitching of back warp into face filling.

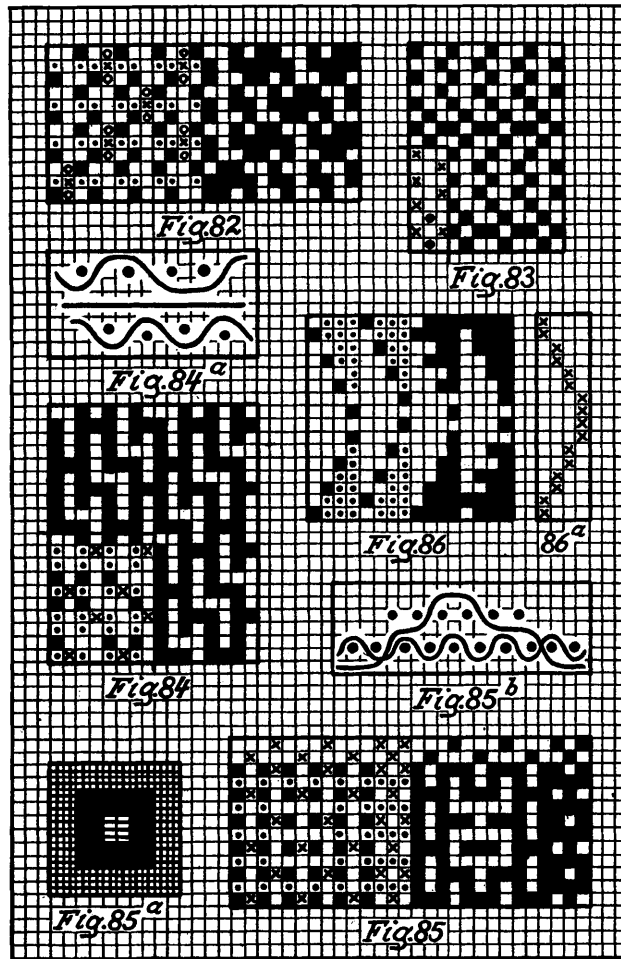
In weave Fig. 83 (in the one repeat, showing construction) the face warp threads are shown by *cross* type and the back warp threads by *dot* type.

#### **Hollow, Double Cloth Weaves with Stuffer Picks.**

Stuffer picks are used to fill out, raise or emboss. in hollow, double cloth weaves, the empty space between the stitchings which unite the two fabrics. This procedure in turn imparts to the design a prominent, raised, *i. e.*, embossed effect.

If using the stuffer pick only for the purpose of a *wadding*; face warp threads then must interlace above, and back warp threads below, said stuffer pick.

If however using the same also in the formation of the effect or design, said stuffer pick then rests off and on, as directed by the design, either above the face structure or below the back structure.



Weave Fig. 84 is constructed with three kinds of filling, *viz.*: Face Back and Stuffer. The face structure is interlaced with 4-harness twill, warp effect; the back structure with plain. The stuffer pick rests between face and back structure.

In the diagram Fig. 84<sup>a</sup> the section of the fabric is given, showing respectively the interlacing of one face, one back and one stuffer pick.

Weave Fig. 85 is constructed with two kinds of filling, *viz.*: a ground pick and a stuffer pick. The back structure interlaces with taffeta weave. The face warp, and which is used minus a face filling, produces a design (a square) on this taffeta ground work. The stuffer pick in turn raises, *i. e.*, embosses this square, producing inside this large square a second small square, resting on all other portions of the repeat of the weave below the fabric structure.

In diagram 85<sup>a</sup> we have shown a sketch of the pattern, and in diagram Fig. 85<sup>b</sup> a section of the fabric structure, *viz.*: a ground and a stuffer pick, the latter resting part the time below the structure, part the time between figure and taffeta warp and part the time above the figure warp.

### Three and More Ply Fabrics.

Rules observed in constructing these fabrics are identical with those observed in constructing two-ply structures.

For this reason; for example, if constructing a four-ply fabric:

*1st.* Plan for lowermost situated structure, considering only warp-threads and picks belonging to it, at the same time raising all the warp threads belonging to the three structures that are to rest above it.

*2nd.* Introduce the weave into the warp-threads and the picks of the structure as is to rest above the first, leaving all the warp-threads of the latter down,

raising at the same time all the warp-threads of the two structures as are to rest above it.

*3rd.* In connection with the picks destined for the third structure, consider then only the warp-thread and picks belonging to the latter fabric structure when inserting the weave, raising all the warp-threads of the face structure, lowering at the same time all the warp-threads belonging to fabric structures one and two.

*4th.* Insert the weave into the face structure, leaving then all the warp-threads of the other three structures down.

As a rule, arrange the successive picks to interlace in rotation in structures 1, 2, 3 and 4, returning back again to structures 3, 2 and 1.

The various structures may be united into one compact fabric, either by using a separate binder warp, or by stitching one structure into the other, using either risers or sinkers for the purpose.

Fig. 86 shows the weave for a 4-ply fabric, each ply interlacing with taffeta (plain).

The introduction of the filling into the various plies is shown at the right hand side in Diagram Fig. 86<sup>a</sup>, viz.:

2	picks	in	<i>first</i>	ply	(bottom)
2	"	"	<i>second</i>	ply	
2	"	"	<i>third</i>	ply	
4	"	"	<i>fourth</i>	ply	(top)
2	"	"	<i>third</i>	ply	
2	"	"	<i>second</i>	ply and	
2	"	"	<i>first</i>	ply	(bottom)

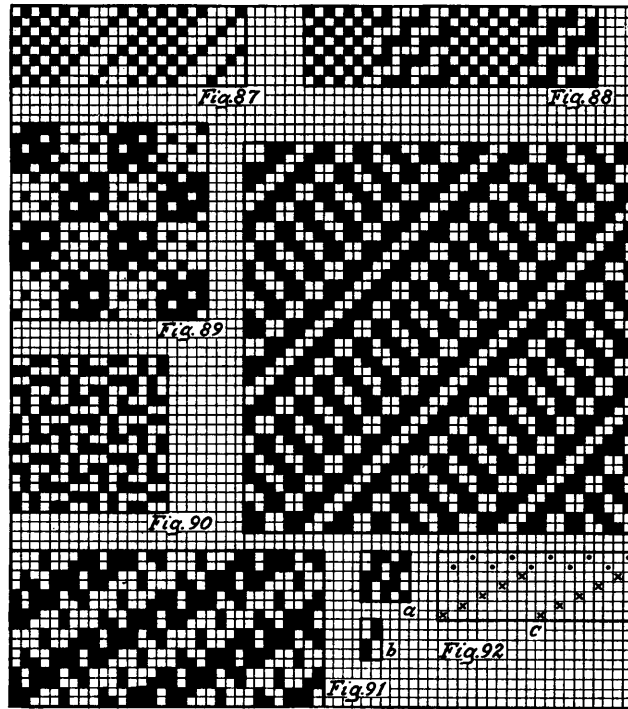
#### **Connected Weaves.**

Two totally different weaves are in this case combined in a new combination weave, forming either stripes or checks.

In designing these weaves always try and arrange a clear break where the two weaves join, *i. e.*, place risers of one weave opposite sinkers of the other weave

and vice versa, whenever possible. Weaves Figs. 87, 88 and 89 explain subject.

Weave Fig. 87 shows how to connect the plain weave (taffeta) with the four harness unevensided twill, filling effect.



Weave Fig. 88 shows the connecting of the plain weave (taffeta) with double plain (double cloth), and

Weave Fig. 89 shows squares of five threads and five picks of 5-leaf satin warp effect, to exchange warp and filling ways with similar size squares of 5-leaf satin filling effect.

**Figured Rib Weaves.**

The same are the checkerboard combinations of warp and filling effect rib weaves, imparting to the face of the fabric a well broken up granite effect.

Weave Fig. 90 explains the subject, showing checkerboards of 4 warp-threads and 4 picks of the 2 *up* 2 *down* rib weave, warp effect, to exchange alternately with similar size checkerboards of the same rib weave filling effect.

**Intersected Weaves.**

Two or more weaves may be in this way used in the formation of a new weave. We may in this way intersect either the warp-threads of the foundation weaves, or its picks, the first mentioned arrangement being the one generally used. Weave Figs. 91 and 92 are given to explain the subject.

Weave Fig. 91 shows us a fancy twill obtained by combining, *i. e.*, drafting alternately (1: 1) warp-threads from the 4 *up* 4 *down* 8-harness regular twill with those of the 2 *up* 2 *down*, 2 by 4 rib weave. Repeat of the resulting fancy twill weave, 16 warp-threads and 8 picks.

Weave Fig. 92 shows the result of intersecting (1: 1) the warp-threads of the 5-harness corkscrew (see diagram *a*) with those of the 2 by 4 rib weave (*b*). Diagram *c* as given below the new weave, shows the plan for drafting, *cross* type standing for the warp-threads drafted from one weave (the 5-harness corkscrew) and *dot* type standing for the warp-threads drafted from the other weave (the 2 by 4 rib weave). Repeat of the new weave obtained is 20 warp-threads and 20 picks.



## SPECIAL WEAVES AND EFFECTS.

### Pile Fabrics.

These fabrics consist in a ground structure into which are secured (interlaced during weaving) floating threads which afterwards are severed in the centre, forming the characteristic pile known as velvet or plush to said fabrics, or loops are formed and left uncut, producing what is technically known as terry pile to the fabric. Cotton, wool, worsted or silk are used for these pile threads.



*Fig. 93*



*Fig. 94*

If a pile thread rests only below one pick or one warp-thread (whether dealing with a filling or a warp pile fabric) previously to entering and leaving the ground structure, such interlacing is known as *Pile-up* (see Fig. 93). If however said pile thread interlaces with several of the ground threads previously to again leaving the ground structure, the same is termed *Pile-through* (see Fig. 94 and where the pile thread interlaces on plain weave for three ends).

There are three distinct pile fabric structures:

- (a) Filling velvet or velveteen,
- (b) Warp velvet or plush, and
- (c) Terry or loop pile fabrics.

#### (a) FILLING VELVET.

*Rule:* After inserting one ground pick (interlacing tightly with the warp-threads) insert several pile picks, *i. e.*, picks floating for a certain number of warp-threads; the length of these floats is regulated by the height of the pile desired.

Drawing the woven fabric warp ways under tension over a table will prominently raise said filling floats, and which are then cut in their centre with a specially shaped, sharp pointed knife, the pile ends thus produced being then in turn, by means of finishing

(sizing) brushing, etc., secured to the ground structure. The longer the floats of the pile picks, the higher the resulting pile will be.

Fig. 95 shows us such a filling velvet weave; one pick taffeta to alternate with 5 pile picks. Repeat of weave, 10 warp-threads and 12 picks. The weave used for the interlacing of the pile picks is the 5-harness satin, considering only every other row of vertical squares in the weave plan.

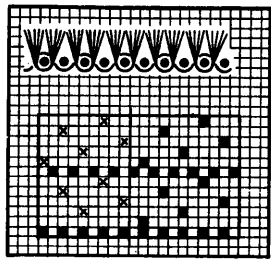
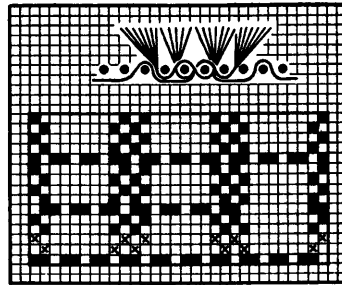
*Fig. 95**Fig. 96**Fig. 97*

Fig. 96 is the filling velvet weave technically known as *Genoa corduroy* (so termed after Genoa, the prominent city of Italy, and where it is said, this weave was first used). The arrangement employed in connection with this weave is: 1 pick ground to alternate with four pile picks. The weave employed for interlacing the ground structure is the 3-harness twill, warp effect. Two sizes of floats for the pile picks are formed, one over six warp-threads, the other over eight warp-threads, this combination imparting to the cord a nice rounding.

These filling velvet weaves also find use in the manufacture of Velveteen Bindings, as used for Dress Protectors. The latter are made either with a single

or a twofold filling, consisting in a ribbon having a velvety edge attached to it during weaving. These bindings are made either of a plain or a fancy structure, in the latter case figures being produced either by an extra warp or extra filling; in some instances these Bindings are woven of a conical shape, serving for connection to the edge of the garment, or they are made in double cloth structures (and when the upper ply is then worked as a figured braid) between which plies the edge of the garment is inserted.

On the ribbon loom each set of warp-threads, technically known as a *gang* (one of the sections of the complete warp) serves for forming two of these bindings. Diagram Fig. 97 is given to illustrate the subject. Starting at the left, it shows one of these bindings by means of the heavy black line, woven in the regular way either as single or double cloth structure. Next, several dents are missed in the reed, after which a few "cutting" threads are drawn in the latter (see dark centre of our diagram) to be followed by empty dents and in turn the other binding. Wool and worsted are used in connection with the better class of these fabrics, cotton for the lower grades.

After the binding is woven, the same is severed lengthways in the centre of the cutting threads (see dark centre of our diagram) and the latter drawn out of the two separated bindings. These cutting threads may also be omitted, the eye then being the only guide in the matter of severing the floating picks between the two fabric structures, each provided on one side with a velour, velvet or velveteen edge. If dealing with a woolen filling, by means of steaming the cut pile edges will become more bushy; again, the more picks per inch inserted, the fuller the pile will be.

(b) WARP VELVET OR PLUSH.

Two systems of warp-threads are used in the construction of these fabrics.

- (1) the warp for the body or ground structure, and
- (2) the pile warp.

The body or ground warp-threads form, by interlacing with the filling, a solid fabric structure.

The pile warp-threads are interwoven with an easy let-off, interlacing off and on into the body structure. After a certain number of picks have been interlaced with the body warp-threads, all the latter are then made to remain in the lower shed, and when in connection with smooth (plain) plush structures, all the pile warp-threads are raised; in connection with figured velvet or plush fabrics only such of the pile threads are raised as required by the design.

At this pick no filling is entered, a brass or steel rod known as a pile-wire, being inserted in its place between the body structure and the raised pile warp-threads. These pile warp-threads are in turn afterwards interlaced again into the body structure of the fabric, thus forming loops, after the pile wires are withdrawn; the height of these loops depends upon the height of the pile wires used.

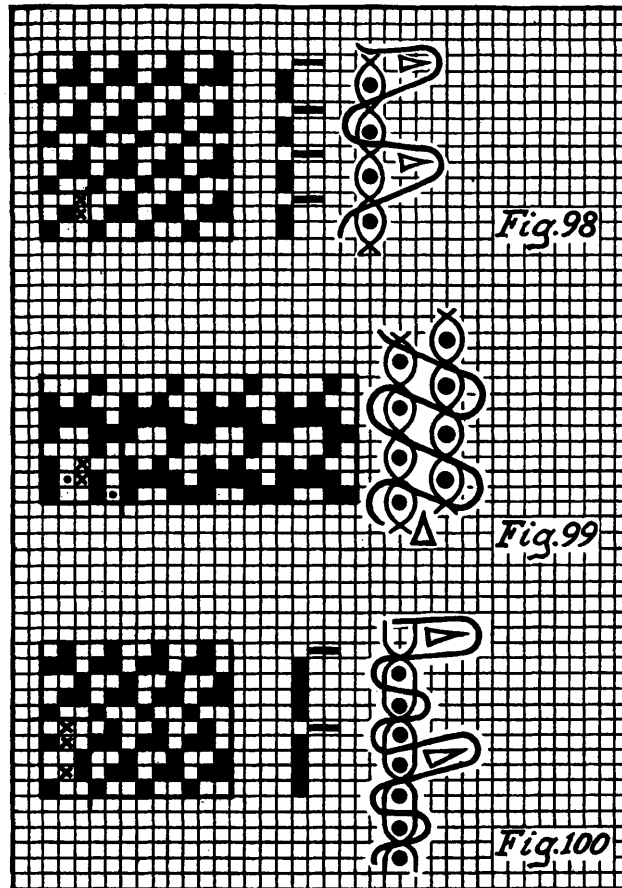
Two kinds of pile wires are used, destined respectively either for uncut or cut pile.

The first are either round or rectangular in their section, resulting in what is termed loop piles in the fabric.

The other kind of pile wires are again of two constructions; either they have one of their ends formed, *i. e.*, enlarged and shaped, into a knife, which severs the loops when the wire is pulled out, or they are plain wires, provided on their top with a groove into which extends the knife of the *trevette* and which knife is made to travel therein across the width of the fabric. Either kind of wires used results in what is known as cut, velvet or plush pile.

Cut and uncut pile in one fabric structure are produced by raising the pile warp-threads over two wires,

a cut and an uncut pile wire. This procedure results in a somewhat higher cut pile compared to the pile not



cut, permitting a clipping of the protruding cut pile later on by the shear, without the blades of the shear cylinder touching the uncut pile. An interesting fea-

ture to note is the fact that in connection with unicolor fabrics, figured with cut (velvet) and uncut (loop) pile, the first will show a darker shade. The number of wires to use per inch at the loom depends upon the character of the fabric structure.

In connection with Double Plush, two body fabric structures are woven on the loom, one above the other. The pile warp-threads interlace in both structures, traveling between said points of interlacings, from one fabric structure to the other.

The pile thus woven is in turn automatically severed in its centre during weaving by a specially constructed knife, traveling near the breast beam of the loom, thus severing said double cloth structure into two single cloth plush fabrics. Two small grindstones are provided over which the knife travels thus keeping itself automatically sharp to produce a perfect severing of the pile warp-threads. One of these grindstones acts, *i. e.*, comes in contact with the one side of the knife, whereas the other grindstone (as located on the other side of the loom) keeps the other side of the knife's edge properly sharpened.

In connection with narrow ware weaving, warp pile weaves are used with velvet ribbons, belts, etc.

Fig. 98 shows us a single plush, *pile-up* weave, using one system of pile warp (see *cross* type) in connection with two picks ground and one wire. The arrangement of the warp, reading from left to right, is:

2 ends ground, see *full* type

1 end pile, see *cross* type

---

3 ends in repeat.

At the right hand side, near to the weave, the scheme for the arrangement of the filling is given, *vis*:

2 picks ground, see *full* type.

1 wire, see *dash* type.

At the extreme right a section of the woven fabric is given, representing the interlacing of the two ground and one pile warp-thread used in one repeat of the weave. Black circles indicate the sections of the filling, of which two repeats are given. The pile wires are indicated by triangles.

Fig. 99 illustrates a weave for a double plush fabric using one system of pile warp to travel from one ply to the other, interlacing the latter with the ground structures of each ply with a *pile-up* arrangement.

Considering one repeat of the weave, 5 warp-threads and 4 picks (see lower left hand corner of weave) we find the following arrangement used for the warp:

- 1 end ground, upper ply, see *full* type.
- 1 " " , lower ply, see *dot* type.
- 1 " pile warp, see *cross* type.
- 1 " ground, upper ply, see *full* type.
- 1 " " , lower ply, see *dot* type.

5 ends in repeat of pattern.

Four picks form the repeat of the pattern.

At the right hand side of the weave a diagram showing the interlacing of the double plush weave is given, both plies interlacing on plain weave and the pile warp interlacing with the ground structures on the *pile-up* principle. Triangle on bottom of fabric section indicates by its point the knife for cutting the pile warp.

Fig. 100 shows us again a weave for a single plush fabric, having its pile warp interlace on the *pile-through* principle.

The weave for the ground structure is the 2 by 4 rib weave.

Repeat of complete weave (see left lower corner of weave) is 3 by 5.

The arrangement of the warp is :

- 1 end ground, see *full* type.
- 1 “ pile, see *cross* type.
- 1 “ ground, see *full* type.

---

3 warp-threads in repeat of pattern.

Diagram next to weave illustrates the arrangement of the filling, to read: 4 picks ground, see *full* type, to alternate with 1 wire, see *dash* type.

Next to it, at the right, is given a diagram showing the interlacing of warp and filling of the fabric structure. The pile wires are indicated by triangles. Following the run of the pile warp throughout the diagram clearly shows its *pile-through* principle of interlacing with the ground structure.

Fig. 101 shows us the weave for a carriage border, constructed with two ground picks and two figure picks, using every time as the fifth pick a wire. The back warp interlaces with taffeta and the face pick is bound by three ends taffeta, of which every time the first and third interlaces with the back structure. One stuffer warp-thread rests in every repeat of the weave, between face and back structure.

The four pile threads, considered in rotation from left to right in our weave, interlace respectively in:

- 1st end, *pile-through*;
- 2nd end, *pile-up*, and
- 3rd and 4th end, part the time *pile-through*, the other time *pile-up*.

In order to accommodate the varying take-up, either pile warp must be put on a separate beam.

Threads 4, 6, 8, 10, 14, 16, 18, and 20 are back threads; threads 7 and 17 are stuffer threads; threads 1, 2, 3, 11, 12, 13 regular warp threads; rows of squares 5, 9, 15, 19 (see *cross* type) indicate the interlacing of the pile warp-threads.

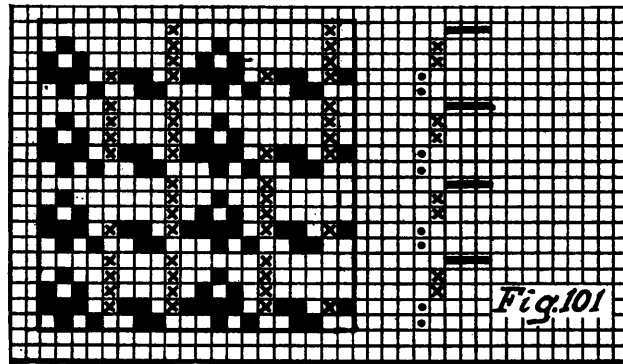
At the right hand side of the weave is given the scheme for the filling and the wire; the back picks are



indicated by *dot* type, the face picks, by *cross* type and the wires, by *dash* type.

DOUBLE VELVET RIBBONS are frequently woven with two shuttles, both traveling in the same direction through the shed, and not, as is the case with Rubber Elastics, in opposite directions.

For such entering of the filling, a double shed must be formed. The warp-threads of the lower structure rise from the bottom to centre (height of the lower single shed); the warp-threads of the upper structure rise from centre to top of upper shed (*i. e.*, the height of the upper single shed). The pile threads in double



plush travel the same as the binder threads in Elastics do, from one ply to the other, through the centre of the fabric, hence have a considerably greater distance to travel as compared to the ground warp-threads of either ply of the double plush.

A loop pile effect, minus the use of wires, is occasionally produced in connection with ribbon weaving by using a heavy count of a cheap yarn, two picks in a shed, to interlace in place of a wire. In order that these two picks do not draw out of the fabric structure, they are made to interlace around a wire at the edges of the fabric, in the same way as is practised in connection with pearl edges.

After the fabric comes from the loom, this waste filling is then pulled out of the fabric structure, re-wound and in turn re-used. This permits us in connection with ribbon looms fitted with banks of shuttles to use them for loop pile structures, minus a wire attachment.

(c) TERRY OR LOOP PILE FABRICS.

In these fabrics the pile is produced, *i. e.*, raised, without the aid of pile wires. They are woven on looms specially constructed for the manufacture of this class of fabrics.

Two systems of warp (on two beams) are necessary, one to carry the pile warp for the formation of the loop, and the other to carry the ground warp for forming the body of the fabric. Only one system of filling is used.

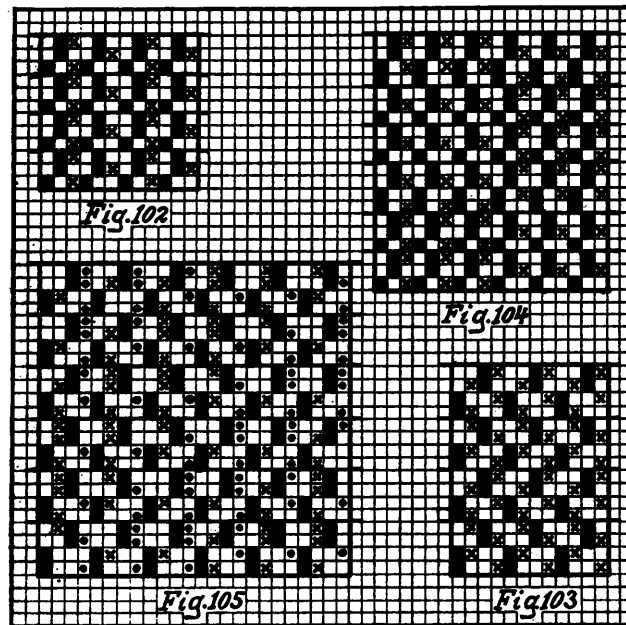
In the process of weaving these fabrics, the terry series of the warp is weighted much looser than the body series, or its warp beam is arranged to let off the proper length of pile warp required at every third or fourth (the tight) pick, so as in either case to allow the loops to be formed on the surface of the fabric, by the lay being driven fully up to the fell of the cloth every third or fourth pick; the two or three previously inserted picks are driven only partly home by the reed. The three or four picks so interwoven, slide on the ground warp, which is let off with a more or less tight tension during the entire process of weaving.

The interlacing of the pile threads correspond to the last pick of the preceding, and the first pick of the successively following ground pick. When high the loop will be driven on the face, when low the loop will be driven on the back of the fabric.

Provided you want to change the position of the loops from face to back, at least four picks must be used before the change in the weave occurs.

This system of pile weaving, in connection with narrow ware fabrics is used for the trimming of plush slippers, velvet and loop pile belts, etc.

Fig. 102 shows one of these loop pile weaves, the arrangement of the filling being three picks for each loop. The arrangement of warp is two ends ground



warp to alternate with one end pile warp. Warp-threads 1, 2, 4 and 5, see *full* type, are the ground warp-threads; warp-threads 3 and 6, see *cross* type, are the pile warp-threads.

Pile thread 3 forms loops on the face of the fabric, on account of interlacing 2 *up* 1 *down*, whereas pile thread 6 forms loops on the back of the fabric, on account of interlacing 1 *up* 2 *down* in the repeat.

Fig. 103 shows us a loop pile weave, arranged with four picks for each loop. The arrangement of the warp is one end ground (see *full* type), to alternate with one end pile (see *cross* type).

Every pile warp-thread, when driving up the picks, rests once on the face, the next time on the back of the structure.

Fig. 104 shows us the pile warp-threads (see *cross* type) arranged to exchange face and back after a checkerboard motive, the loops forming themselves according to this motive either on the face or on back of the fabric. Three picks are used for each group, with four picks at the change of the effect.

Fig. 105 shows us loop piles arranged to form stripe effects, both sides being reversible. The pile threads are shown by *cross* type, and *dot* type.

The heavy horizontal lines drawn in all four weaves thus quoted, show where the lay beats up close to the fell of the cloth, in order to form the characteristic loop, either on the face or the back of the fabric, as previously explained.

#### **Influence of the Twist in the Yarn upon the Fabric.**

Threads in which you take out twist provided you twist them with your hand towards the left, and to which you add twist provided you twist them towards the right, are technically known as *right hand twist*, whereas such threads which untwist provided you twist them towards the right and to which twist is added provided they are twisted to the left are known as *left hand twist*.

Fig. 106<sup>a</sup> shows right hand twist, warp yarn;

Fig. 106<sup>b</sup> shows right hand twist, filling yarn;

Fig. 107<sup>a</sup> is a left hand twist, warp yarn, and

Fig. 107<sup>b</sup> is a left hand twist, filling yarn.

Provided we use in a fabric, warp and filling spun with a hard twist, it will then be advisable to use the same direction of twist for both systems of threads, since in this way the spirals of the twist of warp and

filling will cross, in turn slightly raising the warp threads in the fabric.

Provided we use for the warp a different twist than that used for the filling, the spirals of the twist of both will then more or less interlock with each other, giving in turn a flat appearance to the fabric.

Fig. 106<sup>a</sup>Fig. 106<sup>b</sup>Fig. 107<sup>a</sup>Fig. 107<sup>b</sup>

Besides the twist in the yarn, you must also take into consideration the direction of the twill in the weave.

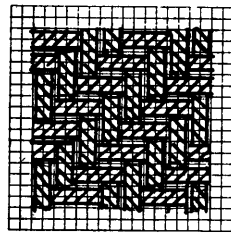
Fig. 108 shows us the 4-harness even sided twill, with its twill line running from left to right, *i. e.*, a right hand twill as we call it; used in connection with a right hand twist warp yarn. The twist of the yarn in this instance runs the proper way, *i. e.*, against the direction of the twill in the weave. Using the other direction of twist for the warp yarn, *i. e.*, a warp yarn twisted to the left, in connection with the same direction twill in the weave would then have the direction of the twist in the warp yarn run in the same direction as the twill in the weave, a combination you will have to omit wherever possible.

For the filling we have used right hand twist yarn, so that the spirals of the twist in the filling run against the spirals of the twist in the warp yarn.

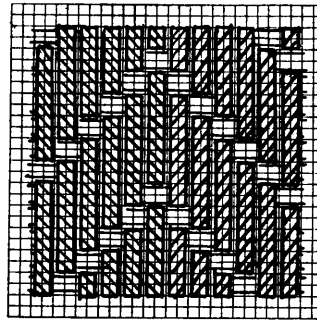
Fig. 109 shows us a pointed twill constructed with proper selection of twist for the warp yarn, *i. e.*, we changed the direction of the twist used for the warp yarn with the change in direction of the twill in the weave. This will explain that in order to properly

bring up these pointed twill effects, *i. e.*, one direction of twill as prominent as the other, both kinds of twist (right and left hand twist yarn) must be used for the warp-threads, according to the direction of the twill.

Of the greatest of importance in the manufacture of ribbons having pearl edges (loop effects produced by floating the filling outside the edges of the ribbon) is the direction of the twist of the filling. These pearl edges, to suit the pattern desired, are produced either on one or on both sides of the ribbon by inserting horse hair threads, or steel or brass wires next to the warp-threads of the ribbon, in the reed. These wires or horse hair threads are secured at their rear ends to the rear framing of the loom, and are drawn into a heddle eye of the harness, and then passed through the reed, close to the side of the fabric, the wire extending close to the breast beam, after which it then pulls itself (during the progress of weaving) automatically out of the loops of the woven fabric. These wires or horse hairs are raised or lowered by the



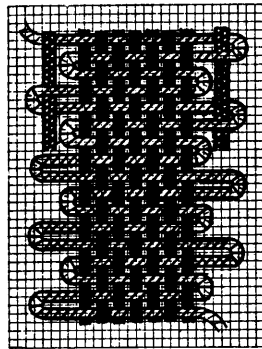
**Fig. 108**



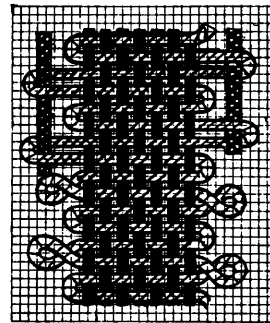
**Fig. 109**

respective harnesses they are threaded to, to suit the desired shape, number and length of loops in the fabric, etc. The filling is caught during weaving by these horse hairs or wires. The take-up of the loom

draws the fabric, as mentioned before, out of the respective horse hairs or wires, in turn forming the characteristic loops to the fabric.



**Fig. 110**



**Fig. 111**

Two kinds of these loops are produced: (a) such as form an open eye, and (b) such where the eye twists itself. As a rule, the first mentioned loops are those desired.

Using a right hand twist filling, and wanting to produce an open loop, have these the wires producing said loop, on both sides of the ribbon in the upper portion of the shed when the shuttle enters from the right hand side, since then the position of the filling around the wires equals untwisting of the latter. If you want to produce with right hand filling a twisted loop, have then your wires which form the loop, on both sides of the ribbon in the upper shed when the shuttle enters from the left hand side. Position of the filling around the wire then equals additional twist to the filling while forming the loop, the latter then, as we call it, hitting themselves upon their heads.

With a left twist filling, in order to obtain an open loop, the wires on both sides of the ribbon must be in the upper shed when the shuttle enters from the left,

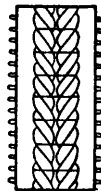
the reverse entering of the shuttle having to take place when a twisted loop is required.

Fig. 110 shows us a fabric sketch of a taffeta ribbon, with open loops, using a right hand twist for the filling. In the upper part of the illustration, the wire, as forming the loop is shown dotted white on a black background, so as to distinguish them from the warp-threads.

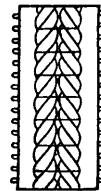
The warp-thread nearest the wire, in every instance, must be in the lower shed when the wire is raised, and vice versa, otherwise this warp-thread would interlace in the loop.

Fig. 111 shows us a fabric sketch of a taffeta ribbon, containing twisted loops, using a right hand twist yarn for the filling. The same as in the previously quoted example, the upper part of the illustration shows the wire as used for the forming of the loop dotted white on black background.

Fancy effects, produced in connection with heavy counts of yarns, containing pronounced curves of twist, are frequently used for the formation of special



*Fig. 112a*



*Fig. 112b*

effects on the face of ribbons; for example, cotton threads twisted with spun silk threads or mercerized cotton, etc. Using two such effect threads, one twisted to the left, one twisted to the right, will produce the pattern as shown in sketch Fig. 112<sup>a</sup>. If we change the position of both threads, the result will be the effect shown in Fig. 112<sup>b</sup>. The more lustrous the material used for these yarns, the more prominent the



curves of the twist will appear to the eye, on account of the reflection of the light.

Using hard twisted warp or filling threads of one direction of twist, the count of which compared to the other threads of the ribbon is considerably heavier (for example, metal twists) the ribbon then will roll itself in the direction of the twist of said threads. To prevent this, have a right hand twisted thread alternate with a left hand twisted thread.

#### **Entering Threads.**

The same refer to fancy edges of ribbon produced by an outside warp-thread or threads floating for a certain number of picks outside of the body of the fabric structure, after which the same interlace similar to the filling into a portion of the ribbon, in turn producing a fancy edge (loop) to the fabric. Either one or both sides of the ribbon may thus be ornamented. These warp-threads are called entering threads, for the reason that they are entered into the body of the fabric structure by means of the filling pulling them into the shed and thus interlacing them.

These entering threads may be used either for the formation of raised figures, for the embossing of warp figures, for producing multi-colored effects, and finally to substitute a cheaper yarn in certain places of the ribbon for a more expensive one.

The chief requirement for a perfect entering of said warp-threads in the body of the fabric structure is that they are let off from their spools under a very loose tension, whereas the filling must come from its bobbin under sufficient tension to pull the entering thread (after engaging with it) for a certain distance across, and into the fabric. Single, two or more fold threads may be used as an entering thread.

If the entering thread rests on the right hand side of the fabric, as shown in Fig. 113, then draw said

entering thread, after all the body warp-threads are drawn in the harness, as the next warp-thread towards the right, using for it a separate harness.

Considering fabric sketch Fig. 113 we see that the filling is first entered for portion *a* to *b* of the fabric in its regular way (plain weaving, for example, throughout the width of the fabric) the entering warp-thread *x* not interlacing with the filling. At *c* we then see that the filling, as entering into the shed from the left, then interlaces with plain weave, up to *d*, the point to which the entering warp-thread *x* is drawn into the fabric structure; from *d* to *e* only those warp-threads are raised as are to rest above the entering thread *x*.

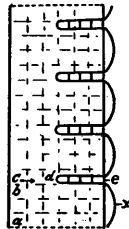
The entering warp-thread, according to its twist, is either raised at the first entering pick and lowered at the second, or vice versa; being caught by the filling, on account of its slack tension, it then can be readily drawn by the latter into the fabric structure.

The second entering pick, coming from the right, after having itself interlooped with the entering warp-thread, pulls the latter into the fabric for the portion *e* to *d* of the shed, which for this purpose corresponds with that of the previous pick, whereas from *d* to *c* regular plain weaving of the warp-threads takes place. The filling, on account of the shed from *d* to *e* being the same for both picks, pulls itself out of this part of the shed, compelling the entering thread to follow into the shed up to the point *d*.

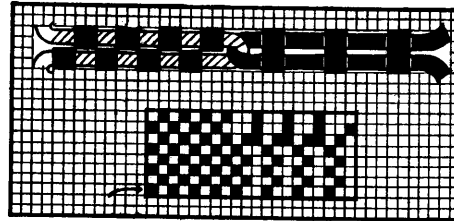
Fig. 114 shows the weave plan for fabric sketch Fig. 113. Above this weave plan, we have diagrammatically shown the connecting, *i. e.*, looping, of the entering warp-thread with the filling. The entering warp-thread is shown in black, the regular filling in outline—shaded and the regular warp in black.

Provided it is desired that the entering thread is to form a larger loop, the same is then made to travel around a wire, passed through the reed, near to the

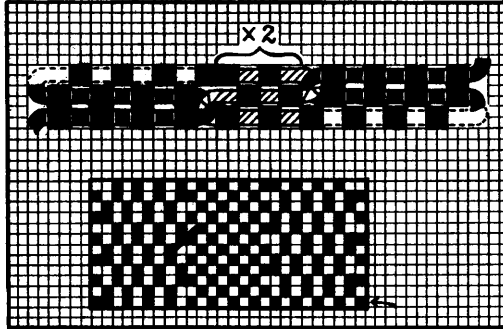
edge of the fabric, and which will hold the entering thread somewhat away from the edge of the fabric, in order to produce the more prominent loop desired. The wire must be alternately raised for two entering picks and in turn lowered for the next two entering picks.



*Fig. 113*



*Fig. 114*

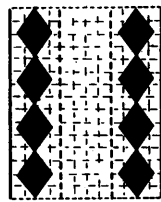


*Fig. 115*

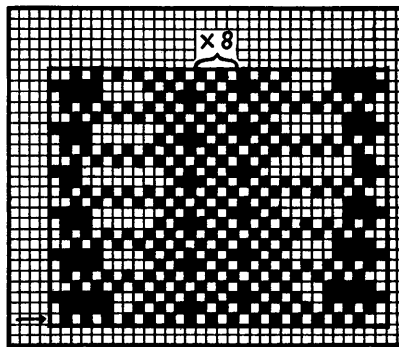
If the entering thread rests at the left hand side of the fabric structure, the entering is done in the same way as in Fig. 114, having the shuttle enter for the first pick from the right and for the next from the left.

Fig. 115 shows the working of an entering thread situated on both sides of the fabric structure. These

entering threads are drawn between the 2 by 4 warp rib, as used for the interlacing of the edges of the fabric, to the center portion of the structure which



*Fig. 116*



*Fig. 117*

interlaces with the taffeta weave. Above the weave is given a plan, showing the interlacing of right and left hand situated entering threads, in connection with its two entering picks. The filling is shown in outlines (shaded) the entering threads and the regular warp-threads being shown in black.

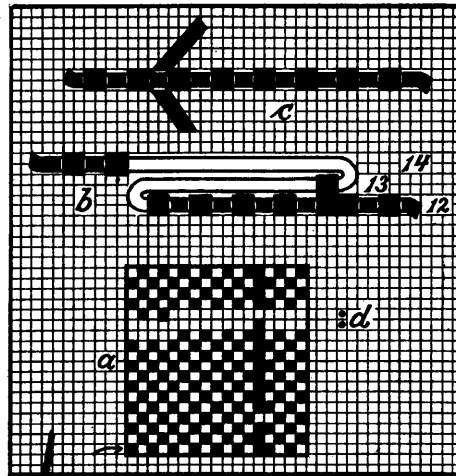
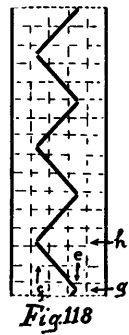
Fig. 116 shows a fabric sketch in which two entering threads form a geometrical figure. Fig. 117 shows the weave-plan for the fabric, face up in the loom.

In connection with fabric sketch Fig. 118, one entering thread is used, the same resting in a *zig-zag* position on the face of the fabric structure. This entering thread is placed into the lower shed on such places where said entering thread has to interlace with the fabric structure, *i. e.*, in places indicated by letters of reference *e* and *f*.

Fig. 119<sup>a</sup> is the weave-plan for producing fabric sketch Fig. 118. The entering thread, shown at *e* in Fig. 118, interlaces with the fabric at the fourth pick

of the weave, by means of being pulled in the lower shed (see *g* in Fig. 118). The filling is then entered, interlacing with taffeta, in the warp-threads up to and including pick 11, the entering thread being, on these picks, always raised.

At pick 12 (see *h* in Fig. 118), the filling is then made to interlace in taffeta up to the point to which the entering thread is to be pulled into the structure (see *f* in Fig. 118) and from there floats above the



warp-threads. Pick 13 passes over all the body warp-threads, but under the entering thread.

Pick 14 rests above the entering thread, the latter being caught by pick 13 and 14, and in turn entered so far until the filling again interlaces with the body warp-threads (see *f-h* in fabric sketch 118).

These three entering picks thus referred to are shown in diagram Fig. 119<sup>b</sup> in detail. The portions of the filling shown in outline, draw themselves together.

On picks 13 and 14, the cloth take-up motion of the loom is automatically brought out of operation, in order to push these picks as close as possible in the shed, said two picks for this purpose being indicated by *d* at the right hand side of weave Fig. 119<sup>a</sup>. Pushing the three picks as close as possible together, they naturally will only occupy the space of one pick on the face of the fabric, as is shown in Fig. 119<sup>c</sup>, and which will at once explain the interlacing of these entering threads in the body structure of the fabric, as shown in fabric sketch Fig. 118.

The best way of drawing-in these entering threads in the harness is to arrange them, so that picks 1 and 3 are entered in the direction in which the entering threads have to be pulled in, the tension of the filling in this way taking better hold upon the entering thread.

Fig. 120 is a fabric sketch showing two entering threads working in opposite directions on the face of a ribbon, forming in this way, a diamond pattern. To produce such an effect in the best possible manner, place the two entering threads where they will work the furthest apart, *i. e.*, points indicated by *a* and *b* in Fig. 120. The drawing together of the two entering threads in the center of the fabric, is accomplished either by means of three or five picks, both arrangements equalling in effect one pick on the face of the fabric, the take-up device on the loom, at these picks being arrested so as to equal the introduction of only one pick with reference to the take-up of cloth roller.

Fig. 121<sup>a</sup> shows us the weave for producing the fabric according to sketch Fig. 120, with three entering picks. On the second pick of this weave, both entering threads are secured to the fabric by means of being pulled into the lower shed. Pick 9, of Fig. 121<sup>a</sup> is the first pick of the three entering picks. The

filling, entering from the left, interlaces in taffeta until coming to the point where the entering threads have to be drawn into the fabric, passing after this below the right hand situated entering thread, sur-

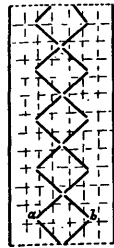


Fig. 120

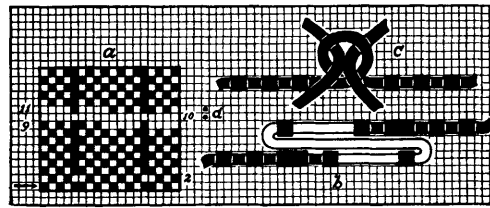


Fig. 121

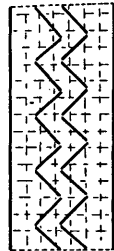


Fig. 123

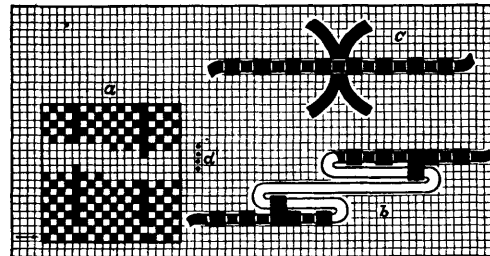


Fig. 122

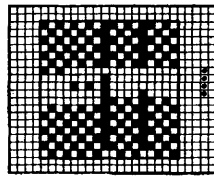


Fig. 124

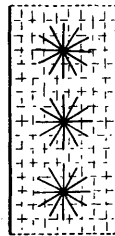


Fig. 125

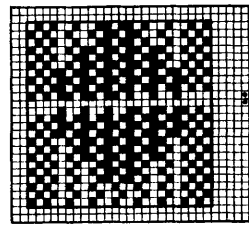


Fig. 126

rounding then, in union with pick 10, this entering thread as situated on the right hand side of the design.

Pick 10, in unison with pick 11, loops around the left hand situated entering thread; pick 11 forming in the body of the fabric the continuation to pick 9.

Fig. 121<sup>b</sup> shows these three entering picks. On account of the tight tension given the filling, and the temporary arresting of the cloth take-up for these three picks, the latter will show in the fabric as one pick. Fig. 121<sup>c</sup> illustrates the position these three picks occupy in the woven fabric, illustrating at the same time the loop, *i. e.*, securing of the two entering threads to the body structure of the ribbon.

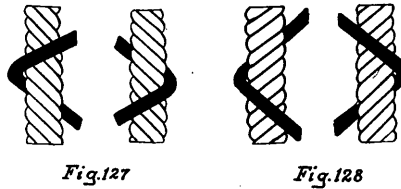
The entering threads which rest in the center of the ribbon, must be added in the advance-reed, the body warp being threaded regularly. Fig. 121<sup>d</sup> shows the two picks where the cloth take-up is thrown automatically out of action.

Fig. 122<sup>a</sup> shows us the weave necessary for producing fabric shown in sketch Fig. 120 with five entering picks. The second and the third entering pick loop with the entering warp-thread as situated at the left hand side, the third and fourth entering pick looping with the entering thread as situated at the right hand side of the fabric, a procedure clearly shown in diagram 122<sup>b</sup>. Portions of threads shown in outline are compressed in the loom, resulting in the appearance shown in diagram Fig. 122<sup>c</sup>, the compressing of the five picks into apparently one, on the face of the fabric being accomplished by means of temporarily arresting, at these five picks, the take-up motion of the cloth roller. Using five picks produces a smoother interlacing of the entering threads compared to that of using only three. Fig. 122<sup>d</sup> indicates the four picks where the take-up of the cloth roller is thrown out of action.

Fig. 123 shows us two entering threads resting parallel with each other on the face of the ribbon. Either entering thread must be connected to the fabric by means of a separate pick, as shown in weave plan Fig. 124.



Fig. 125 shows us a sketch for a ribbon, executed with six entering threads, all of which, as shown in weave Fig. 126 are drawn together in the middle of the ribbon by means of three entering picks. The entering threads must, in connection with this pattern,



on account of their different interlacing in the fabric structure, be divided into 3 warps @ 2 threads.

If using for the entering threads a yarn showing prominent sharp twisted spirals, place the entering loops of the filling so that the latter will not be caught in the spirals of the entering threads.

Fig. 127 shows proper looping of a left and a right hand situated entering thread having right hand twist spirals.

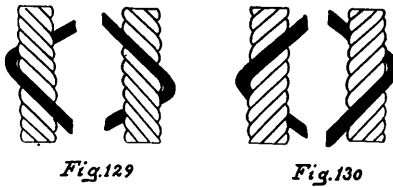


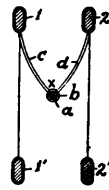
Fig. 128 shows proper looping of a left and a right hand situated entering thread having left hand twist spirals.

Fig. 129 shows wrong looping of two entering threads having right hand twist spirals.

Fig. 130 shows wrong looping of two entering threads having left hand twist spirals.

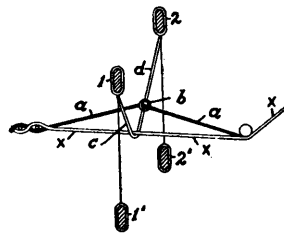
**Gauze or Leno Weaves.**

Two different systems of warp-threads are used in connection with these weaves:

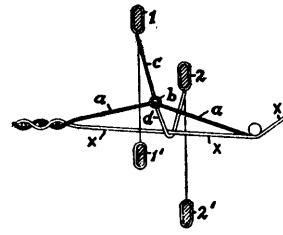


*Fig. 131*

- (1) The Standard threads, also termed stationary threads, which are weighted heavily, and
- (2) The Whip or Douping threads, which twist or doup (back and forth) around the standard threads.



*Fig. 132*



*Fig. 133*

They work with a somewhat looser let-off, to allow for their douping.

This twisting, *i. e.*, douping of the whip threads around the standard threads may be done either from above or below. The latter way is the one most

frequently made use of, *i. e.*, the whip threads are raised from below, alternately on one and then on the other side of its mate standard threads, being in either instance held in position by one or more picks, as the pattern designates.

The standard and its mate whip thread (or threads of either system, provided more than one thread for each system is used), as twisting against each other, must be threaded into one dent, so as to permit douping.

The raising of the whip thread or threads cannot be done by means of common heddles, requiring for this work douping devices, of which we will refer to those most often met with:

#### DOUPING HARNESES PROVIDED WITH HALF HEDDLES.

This arrangement of douping is best explained in connection with diagram Figs. 131, 132 and 133.

Two empty harness frames 1, 1' and 2, 2' are used. The whip thread *a* is threaded into a round glass or porcelain eye *b* to which on either side is also threaded a douping heddle *c* and *d*, the first being secured to the top rod 1 and the latter secured to the top rod 2, of the respective harness frames. The standard warp-thread *x* is threaded above the eye *b* as carrying the whip thread *a*.

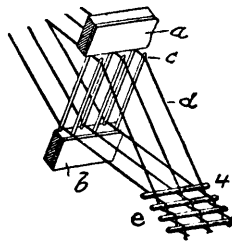
Raising harness 2, 2' and lowering harness 1, 1' (see Fig. 132) will cause the raising of the whip thread *a* at the right of its mate standard thread *x*.

Reversing the lift of the harnesses (see Fig. 133) raises the whip thread *a* at the other side of its mate standard thread *x*. In either case the standard thread remains down.

If the twisting is to be done from above, secure the douping heddles to the lower rods 1' and 2' of its respective harness frame, placing the standard warp-thread then below the glass or porcelain eye, as carrying the whip thread. In order to more clearly show

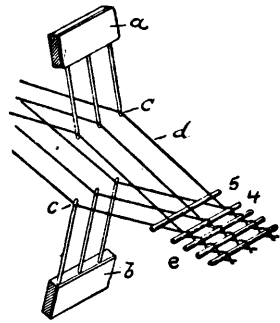
up the twisting of the whip thread *a* around its mate standard thread *x*, the first is shown in Figs. 132 and 133 in full lines, the latter in outlines.

DOUPING BY MEANS OF NEEDLE COMBS.

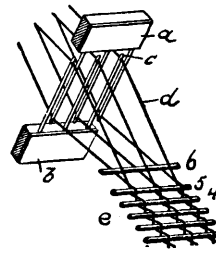


*Fig. 134*

Diagrams Figs. 134, 135 and 136 are given to illustrate subject. In this instance a pair of needle combs take the place of the doup harness, its half



*Fig. 135*



*Fig. 136*

harness, and the two ground harnesses as are used in the regular way of doubling, later on referred to under the sub-heading of Douping with Half Harnesses. As seen from the three illustrations referred

to, two combs are provided, the same working in unison. One of the combs, indicated by *a* in our illustrations, has its needles pointing downwards, whereas its mate comb *b* has the needles pointing upwards.

Each needle in both sets of combs is provided with an eye *c* through each of which one warp-thread *d* is drawn. One needle of one comb works with one needle of the other comb as its mate, throughout the entire operation of weaving.

The operation of doubling, with reference to the accompanying three diagrams (illustrating the needles or prongs of the comb as carrying the warp-threads in the three different extreme positions during weaving) is thus:

The eyes in the needles of both combs are shown threaded with the warp-threads *d*, while the picks are indicated by letter of reference *e*.

Fig. 134 shows both combs closed, pick 4 being inserted.

Fig. 135 shows the combs parted from each other (one raised—one lowered) and what will interlace, *i. e.*, tighten pick 4 to the web, giving us a chance to introduce pick 5 in the shed produced by the loom.

Next, a side way movement is imparted automatically by the loom to the comb *b*, causing the warp-threads to twist around each other when both combs come again together as shown in Fig. 136. Pick 5 is then beaten up by the reed to the fell of the cloth, and a new pick (see 6) inserted into the shed.

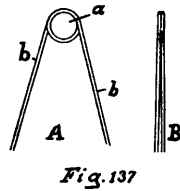
Both combs in turn again separate from each other, pick 6 being bound in by the warp-threads, the reed driving pick 6 up to the fell of the fabric and when a new pick is then inserted in the shed.

A sideways movement is then again imparted to comb *b*, but this time in the reverse direction from that before, and when upon closing both combs the

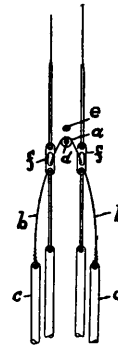
position of the needles referred to in connection with Fig. 134 is again obtained, and the round of douping is completed.

METAL DOUPS.

The same are made use of more particularly in connection with Jacquard ribbon weaving, although off and on they are also used in connection with harness work. Said metal doups (see diagram Fig. 137, of which *A* is the front and *B* its side view) are made to form an eye *a* on their top for carrying



*Fig. 137*



*Fig. 138*

the whip thread. Its two legs *b* are inserted into the mails (eyes) of the two harness heddles, which by means of raising and lowering, produce the crossing, *i. e.*, twisting of the whip thread with its mate standard thread. It will be advisable to use for these two heddles, *i. e.*, harness cords, if possible the first two cords of the row deep in the comber board.

After inserting the two legs into the mails of the respective harness cords, fasten to them their lingoes; next pass the standard warp-thread between the two harness cords and above the eye of the metal doup.

Diagram Fig. 138 is given to illustrate the sub-

ject, and where letters of reference indicate thus: *a* the eye of metal doup, *b* the legs of said doup, *c* the lingoos of the metal doup, *d* section of whip thread, *e* section of standard thread, and *f* the mails of the two harness cords.

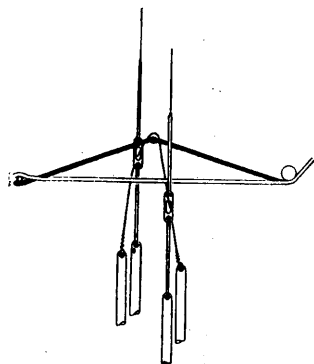


Fig. 139

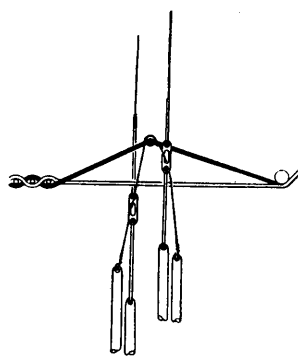


Fig. 140

Raising one of the harness cords, for instance the one at the left of the standard, will raise (see Fig. 139) the whip thread on that side of the standard thread.

Raising in turn the other harness cord (the one at the right hand side of the standard) will raise (see Fig. 140) the whip thread on that side of the standard thread.

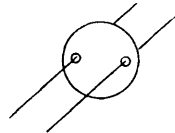
Never raise both harness cords at one time, since this would raise the whip and the standard thread, the filling then passing below both.

In connection with metal doups, or douping harnesses provided with half heddles (see Figs. 131, 132 and 133) the standard threads remain continually either in the lower or in the upper shed; no special harnesses or harness cords are thus required for carrying the standard threads. However, if besides

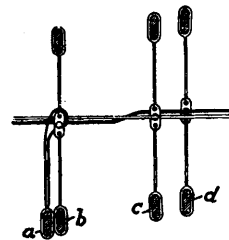
douping, regular weaving has to be done at times throughout the repeat of the pattern, special harnesses or harness cords are then required for carrying the standard threads. When twisting has to take place, at that pick the standard warp-thread must be always in the lower shed.

WHEEL OR DISC DOUPS.

In connection with some fabrics, wheel or disc doups are used. Diagram Fig. 141 shows us such



*Fig. 141*



*Fig. 142*

a doup with two warp-threads threaded into it. During weaving, this wheel or disc is then, by means of any suitable contrivance (cams or gearing), alternately turned in one direction and then in the other. The result is not actual gauze or leno weaving, but only a twisting of the threads alternately in one and then the other direction.

DOUPING WITH HALF HARNESSSES.

Diagrams Figs. 142, 143 and 144 are given to explain this system of douping.

Fig. 142 shows the standard warp-thread entered in the heddle eye of the regular harness *c*; in a similar manner the whip thread is threaded first in the heddle eye of its mate regular harness *d*, after which it is passed through the doup which is secured to the bottom of the half harness *a* and threaded to the eye



of its mate harness *b*. The whip thread is shown threaded at the left from the doup.

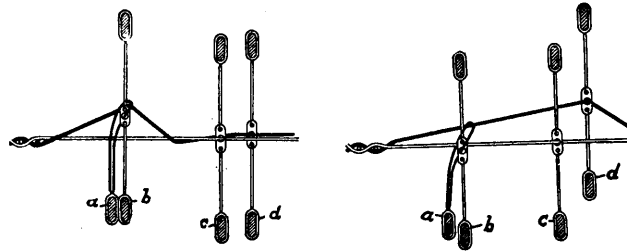


Fig. 143

Fig. 144

Raising harness *b* and half harness *a*, and which means the complete doup, will raise the whip thread, resulting in a twisting of the latter to the right hand side of the standard thread (see Fig. 143).

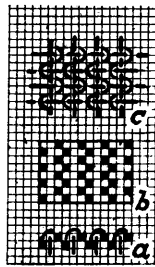


Fig. 145

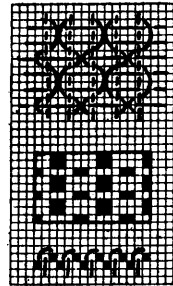


Fig. 146

Raising harness *d* will raise the whip thread (drawing with it the doup *a* with its raised half harness) at the left hand side of the standard thread (see Fig. 144).

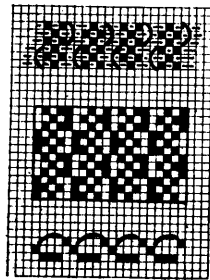
*A Few Gauze or Leno Weaves.*

Fig. 145 shows us at *a* the arrangement of the

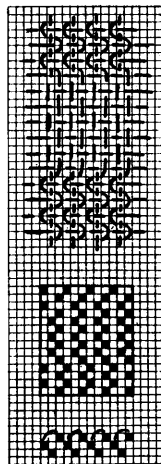
doups and the standard threads. Such of the threads as are shown connected by brackets belong to one set. *b* indicates the weave and *c* a diagram of the fabric structure.

Fig. 146 illustrates a larger doup effect.

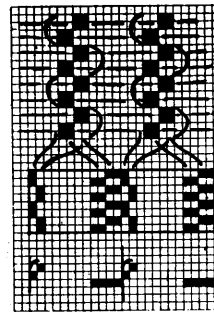
Fig. 147 shows one thread doubling around three standard threads as are interlacing with the plain weave.



*Fig. 147*



*Fig. 148*



*Fig. 149*

Fig. 148 shows a fancy gauze fabric, threads interlacing part the time with gauze and part the time with regular weaving.

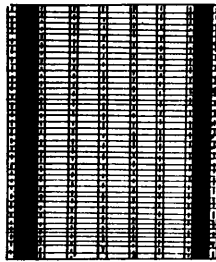
Fig. 149 illustrates a gauze weave for Jacquard fabric structure using a 12 row deep harness. To the first two mails of every row of harness cords (row deep in the comber board) metal doups are provided. The rear four harness cords carry the standard threads as work on plain weave.

**Ribbons Made With Open-work Stripes.**

Fig. 150 shows such an open-work ribbon.

The edges show taffeta, next to each a satin stripe (8-leaf satin) followed again on either side of the latter by a taffeta stripe.

The body of the ribbon is formed by leaving five times in rotation several dents in the reed empty, the filling in said open places being held in position by



*Fig. 150*

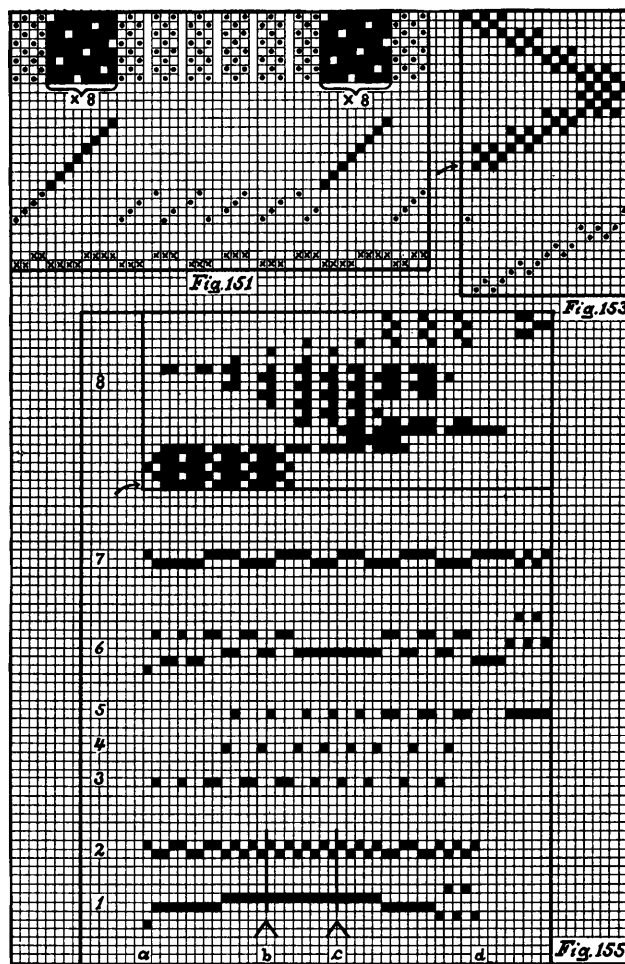
four sets of threads, each set composed of three warp-threads, the same interlacing with taffeta.

Fig. 151 shows the weave required for producing ribbon shown in Fig. 150. Three sets of warp-threads are used, *viz*:

(1) The warp for the edges of the fabric, comprising eight warp-threads (four warp-threads on each side of the satin stripe) on each edge of the ribbon, each set working on taffeta.

(2) The four sets of three warp-threads each for the centre part of the ribbon, and which also interlace with taffeta.

(3) The warp for the face effect stripe for each edge of the ribbon and which calls for  $(8 \times 8 =)$  64 warp-threads, interlacing with the 8-harness satin, warp effect.



Below the weave, its drawing-in draft is given, using corresponding type, *viz*:

*Dot* type for the 4 harnesses carrying the warp-threads for the plain portions of the edges, as well as those for the centre stripes, both sets of warp-threads working on taffeta.

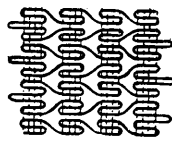
*Full* type for the 8 harnesses carrying the two satin stripes. The complete draft calls for 12 harnesses, section draw.

Below the drawing-in-draft the entering of the warp-threads in the reed is given, shown in *cross* type.

The two taffeta edges, of four threads each, are drawn with two ends per dent. The satin stripes are reeded four ends per dent or sixteen dents for the sixty-four ends of each satin stripe. The four taffeta stripes between the edges of the ribbon are drawn with three ends per dent, *i. e.*, each stripe is drawn in one dent, leaving four or more dents empty between each of these stripes.

#### Passanterie Trimmings.

Fig. 152 shows a passanterie trimming, illustrating the interlacing of four panels; Fig. 153 shows the weave for producing this trimming.



*Fig. 152*

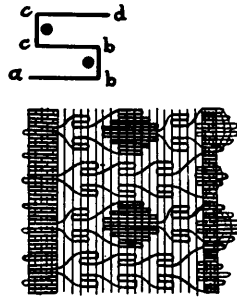
The latter shows that the filling enters successively for three picks into one panel, the third pick in one panel being at the same time the first pick for the joining panel, in this way, connecting all four panels into one fabric structure.

The warp-threads of each panel must at least be entered into two dents of the reed, since if they were threaded into one dent only, the reed would not be able to drive the filling home, it would simply lay itself between the two reed wires.

Between the panels leave one, two or more dents empty, so as to produce the open space.

The take-up of the loom must only act whenever the interlacing of one panel is completed, *i. e.*, its three picks having been inserted. At the other picks the take-up must be released, which in turn will beat up the picks inserted in the respective panel.

Below the weave, the drawing-in-draft for 10 harnesses is given, shown by means of *dot type*.



**Fig.154**

Fig. 154 shows another sketch of a passamenterie trimming.

To produce such broad trimmings, in connection with looms constructed for weaving only narrow trimmings, such broad trimmings, as shown in Fig. 154, may be woven in two, three or more-ply arrangement, weaving one ply above the other. The trimming then is woven, bent in its width in two or three sections, overlapping each other (one above the other) in the loom, the number of folds overlapping each other depending upon the width of the trimming to be made.

In this case, when planning the weave remember that not only the rules governing the construction of double cloth hold good, but that, at the same time, you have to take into consideration the dividing of the warp-threads according to the threading in the reed of the single cloth trimming, in order that the warp proportions remain correct.

Between the folds of every two plies thus arranged, place several stuffer warp-threads, which after the fabric leaves the loom are taken out. These stuffer warp-threads will take up the tension of the filling; without them, the warp-threads in the plies would be subjected to an excessive tension.

Fig. 155 shows us the weave plan for fabric Fig. 154, executed on a three-ply basis.

*Details with reference to diagrams given in Fig. 155:*

Diagram 1 shows the threading of the warp in the single cloth structure.

Diagram 2 illustrates the threading in the reed for the single cloth structure with indications (lengthwise, see heavy ruled lines) for the folds for weaving the latter by the three-ply basis. The same must be selected so as to make as few double picks as possible. These folds are indicated by letters of reference *b* and *c*.

Above fabric sketch Fig. 154 the formation of the single cloth fabric by the three-ply basis is given, *viz*: *a - b* first-ply of the plan; *b - c* second-ply, and *c - d* third-ply.

Diagram 3 in Fig. 155 indicates the warp-threads for the first plan of the fabric structure (*a - b* of Fig. 154).

Diagram 4 in Fig. 155 indicates the warp-threads for the second plan of the fabric structure (*b - c* of Fig. 154).

Diagram 5 in Fig. 155 indicates the warp-threads

for the third plan of the fabric structure (*c-d* of Fig. 154).

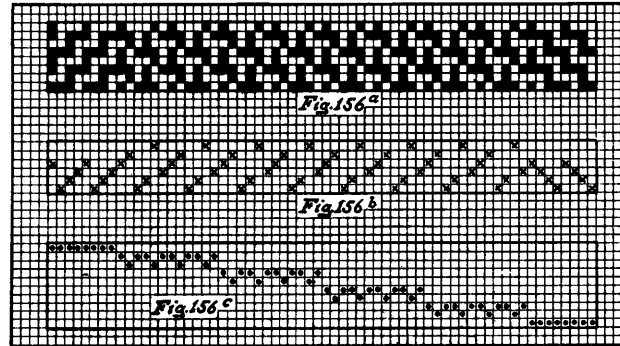
Diagram 6 in Fig. 155 shows the plan for the complete threading of the single cloth trimmings, thus woven by the three-ply plan.

Diagram 7 in Fig. 155 shows the threading of the reed for the trimming thus woven by the three-ply plan.

Diagram 8 in Fig. 155 shows a portion (the start) of the complete weave for the trimming shown in Fig. 154, by the three-ply plan.

#### **Conical Shaped Ribbons.**

Fig. 156<sup>a</sup> shows the weave for such a conical woven ribbon.



For the interlacing of the centre-threads we find used (intermixed) double taffeta and warp rib weave.

Since the ribbon is short on one side, becoming longer towards the other, the warp-threads must on account of their varying length be bunched in the shape of stripes into one warp.

Diagram 156<sup>b</sup> shows the fancy draw of weave Fig. 156<sup>a</sup>, arranged for 6-harnesses.

In weave Fig. 156<sup>a</sup> the complete number of warp-

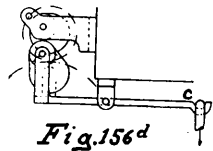


threads, as shown below it in diagram 156<sup>e</sup>, are divided upon ten warps.

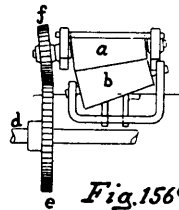
TAKE-UP FOR THESE RIBBONS.

Various designs for the take-up of conical ribbons have been constructed, diagrams Figs. 156<sup>d</sup> and 156<sup>e</sup> showing side and front elevation of one style of construction. Other parts of the loom for weaving these conical ribbons, are the same as those for looms for regularly woven ribbons.

The device shown in illustrations is secured to the breast beam of the loom. The uppermost located conical roller *a* is placed in an oblique position in order



*Fig. 156<sup>d</sup>*



*Fig. 156<sup>e</sup>*

that its top face line is parallel with the face of the lay of the loom.

The lower situated conical roller *b* presses with its face closely to that of the upper roller *a*, being held in contact with the latter by means of weighted lever *c*.

The regulator (take-up) of the loom acts upon shaft *d* which carries a series of gears *e*, each in turn meshing with a gear *f*, which operates roller *a*. As many of these individual take-up devices are provided as there are ribbons to be woven on the loom.

It will be readily understood that the conical rollers *a* and *b* take up less fabric structure on their portions presenting smaller diameters compared to such presenting larger diameters, this variation in diameter of the take-up rollers being the cause of the formation of the conical ribbons.

**Ribbons Showing Raised Loops.**

Fig. 157 shows us a sketch of such a ribbon. In the same the ground is to be interlaced with taffeta, the loops (as shown by oval spots) to be produced by floating the filling around wires, placed in proper position through dents of the reed.

Fig. 158 shows the weave plan for producing such a fancy ribbon, the lay-out referring to a single shuttle loom. An explanation of this weave plan will show how these loops are formed on the face of the ribbon.

*Arrangement of Warp:*

6 warp-threads (Set *a*)  
 1 wire  
 4 warp-threads (Set *b*)  
 1 wire  
 4 warp-threads (Set *c*)  
 1 wire  
 6 warp-threads (Set *d*)

—  
 23 ends repeat of pattern.

*Dot* type shows the warp-threads interlacing with the filling on taffeta.

*Full* type shows the raising and lowering of the three wires, *e*, *f* and *g*.

Repeat of Filling pattern shows 32 picks.

The filling to enter pick 1 from the left, see arrow *h*.

Picks 1, 2 and 3 and 4 interlace with taffeta for all the warp-threads, with all three wires raised.

Pick 5. Filling enters from the left. Warp sets *a* and *b* interlace on taffeta, *c* and *d* are down; wires *e* and *f* are raised, *g* is down. The shuttle in entering the shed draws the filling along, the latter becoming hitched to the fabric structure by wire *f*.

Pick 6. Filling enters from the right, no warp-threads or wires being raised, the shuttle consequently drawing the filling along, the same being hitched by and around wire *f* to the fabric.

Pick 7. Filling enters from the left. Warp sets *a* and *b* are down, sets *c* and *d* interlace with taffeta; wire *f* and *g* are up, wire *e* is down. The shuttle in passing this shed draws the filling along, the latter

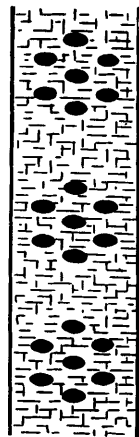


Fig. 157

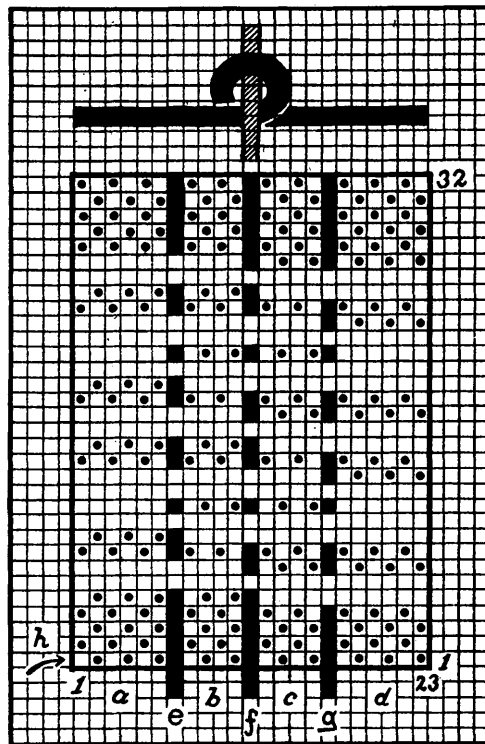


Fig. 158

becoming hitched to the fabric structure by wire *f*.

This procedure completes the first loop, shown in the centre set at the bottom of fabric sketch Fig. 157; three picks are required for the formation of each

loop. The filling caught by wire *f* after thus causing the formation of the loop referred to, in turn interlaces with taffeta in connection with warp sets *c* and *d*, the shuttle being then on the right hand side of the loom.

Pick 8 is a clear taffeta pick, throughout the entire width of the fabric, the same as picks 2 and 4 previously referred to, *i. e.*, all four sets of warp-threads (*a, b, c* and *d*) interlace on taffeta, all three wires being raised, *i. e.*, out of the way of the filling.

Picks 9, 10 and 11 form the first loop from the bottom, in the first or left hand row of loops shown in fabric sketch Fig. 157, the loop hitching then around wire *e*. The filling for this purpose enters, interlacing with taffeta in pick 9, into warp-set *a*, passing in turn under wire *e*, and over all the other warp-sets and wires; in pick 10 the filling is made to pass over all the wires and warp-sets, and in pick 11 under wires *e, f* and *g*, interlacing with taffeta only into warp-sets *b* and *c*.

Picks 11, 12 and 13 in turn form the first loop on wire *g, i. e.*, the first loop from the bottom seen on the right hand row of loops in fabric sketch Fig. 157. The filling on leaving the fabric on pick 11 under wire *g*, in turn on pick 12 passes over this wire as well as the other two wires, without interlacing with the warp-threads of the fabric, and in turn in pick 13 passes without interlacing into warp-sets *a, b* and *c*, and above wires *e* and *f*, then under wire *g*, in turn interlacing with warp-set *d* on taffeta.

Pick 14 is identical with pick 4, and when picks 15, 16 and 17 then produce the second loop on wire *f*, it being the second loop in the centre row of loops, considered from the bottom, in fabric sketch Fig. 157.

Pick 18 is a duplicate of pick 8 previously referred to, and in the same way picks 19, 20, 21, 22 and 23, duplicates of picks 9, 10, 11, 12 and 13 previously re-

ferred to, producing in the same way as before explained, the second set of loops on the two outside wires, *e* and *g*, in the repeat of the pattern.

Pick 24 is a duplicate of picks 4 and 14, and picks 25, 26, and 27 duplicates of picks 5, 6, and 7, as well as 15, 16 and 17, in turn producing the third loop on wire *f*, it being the third loop in the centre row in fabric sketch Fig. 157. This finishes one repeat of the figure effect in the fabric.

Picks 28, 29, 30, 31 and 32 form the five plain ground picks, interlacing on taffeta, and connect to the four picks with which we started the weave plan, making altogether nine picks of taffeta to be introduced before starting on the next set of seven loops as forming the next repeat of the pattern.

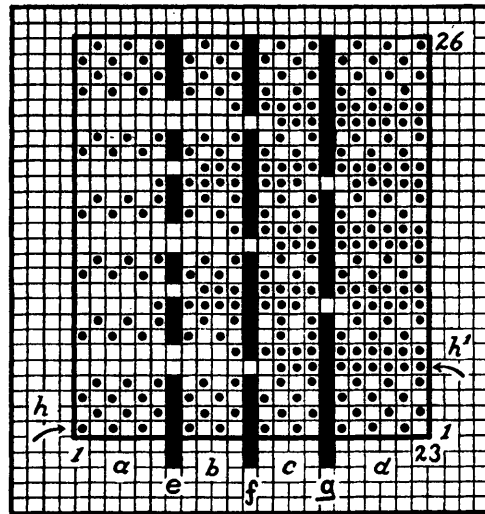
Where three picks are required to form one loop, the first and last of said three picks (5, 6 and 7) produce combined one taffeta pick, the centre pick (6) not coming into consideration, since the latter does not interlace, only changing the position of the shuttle in loom to permit the formation of the loop, for which reason the take-up of the loom must be arrested for two of these loop forming picks.

Where five picks are made to form two loops, said five picks (9, 10, 11, 12 and 13) produce combined one taffeta pick, for which reason the take up must be arrested for four of these loop forming picks. The one taffeta pick thus referred to is formed by the four sets of warp-threads thus:

Set *a* on pick 9, sets *b* and *c* on pick 11, and set *d* on pick 13.

Fig. 159 gives us the weave for producing fabric shown in Fig. 157, by means of two shuttles. In connection with this weave we then can use two kinds of filling yarn, differing either in kind of material, color or count, or in all. The loops may be formed with three picks, as was the case with the one shuttle plan, or we may prefer to save a number of picks in the repeat of pattern, and when, as is shown in weave

Fig. 159, every pick is used in the formation of one as well as more loops. In this instance considerable more loop yarn will rest useless on the back of the ribbon, detracting from its good appearance. It is not advisable to form too many loops, side by side, with one pick since then the loop pick, provided if of a heavier count, and which generally is the case, will



*Fig. 159*

place the finer ground picks too irregular in the fabric structure.

Type used in connection with weave Fig. 159 is selected to correspond with that used in weave Fig. 158. Arrow *h* in weave Fig. 159 indicates the entering of the fine count of yarn, or color No. 1, as used for the ground effect filling, entering the shed at the left. Arrow *h'* indicates the entering of the heavy count, or color No. 2 filling as forming the loops, entering the shed at the right hand side of the fabric structure. Repeat of Weave 23 by 26.

**Ribbons Showing Cat-stitch Effects.**

This method of figured effects for ribbons is explained by means of Figs. 160, 161 and 162, showing respectively fabric sketch, weave and diagram of formation of the cat-stitch.

The same refers to a 2-shuttle effect, *viz*:

(*a*) the regular or ground weaving shuttle, and which carries a yarn of high count, interlacing with the ground warp on a closely interlacing weave, in the present instance, the taffeta weave, the most satisfactory one to use.

(*b*) the figure or cat-stitch weaving shuttle and which, as a rule, carries a heavy count of filling, often two or more fold, and of a contrasting color to that used for the ground warp and the ground filling.

The peculiar cat-stitch effect is produced by floating the figure filling *b* below a certain number of warp-threads taken in bunches, *i. e.*, rotation. After this, interlace a certain number of ground picks *a* (four picks in our example) after which the figure pick *b* is again interlaced, floating below a certain (but different selected) bunch, or number of warp-threads taken in rotation.

It will be readily understood that the figure pick will float in an oblique direction on the face of the fabric, between the point where it left the first figure pick and the point where it entered the next figure pick.

Figs. 161 and 162 explain the subject.

Warp-threads 1 to 8 are ground threads.

Warp-thread 9 is a figure thread.

Warp-threads 10 and 11 are ground threads.

Warp-thread 12 is a figure thread.

Warp-threads 13 to 20 are ground threads.

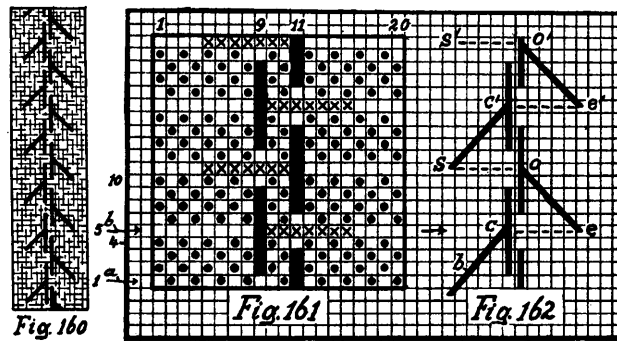
The interlacing of the ground warp-threads is shown by *dot* and *cross* type, respectively for the four ground picks and one figure pick.

The interlacing of the figure warp is shown by *full* type, in order to show the backbone of the cat-

stitch (as it produces in the fabric) in diagram Fig. 162, and where the two heavy vertical lines correspond to the two figure warp-threads 9 and 12 in weave Fig. 161.

Picks 1, 2, 3 and 4 are ground picks (see *dot* type). The shuttle is entered in the regular way, beginning with pick 1 from the left hand side.

Pick 5 is the first figure pick (see *cross* type). Warp threads 9, 10, 11, 12, 13, 14, 15 and 16 are up, the rest are down. The figure filling enters to



the back of the fabric structure at the left hand side of the warp-thread 9 (see point *c* in diagram Fig. 162) appearing again on the face of the ribbon at the right hand side of the warp-thread 16 (see point *e* in diagram Fig. 162).

Picks 6, 7, 8 and 9 are again four ground picks (as before).

Pick 10 is the second figure pick in our example. Warp threads 5, 6, 7, 8, 9, 10, 11 and 12 are up. The figure pick enters to the back of the fabric structure at the right hand side of the warp-thread 12 (see point *o* in diagram Fig. 162) returning to the face of the fabric structure at the left hand side of warp thread 5 (see *s* in diagram Fig. 162).



This will show that the figure pick floats on the face of the fabric (in an oblique direction) from *e* to *o* and in connection with the next five picks of the second repeat of the weave, from *s* to *c'*, in a reverse oblique direction from that of the first float.

Figure warp-threads 9 and 12, of weave Fig. 161, and which are floating threads, are of a similar count of yarn and color as the figure pick; they are consequently shown in sketch Fig. 162 by heavy lines, corresponding to the oblique lines produced by the figure filling. Repeat of weave: 20 warp-threads and 10 picks. 12-harness fancy draw.

As will be readily understood, this number of warp-threads and picks in the repeat of the weave can be increased in the loom, when a more prominent effect is desired, without increasing the number of harnesses required. Two repeats in length of weave Fig. 161 and diagram Fig. 162 are given to better illustrate fabric formation. Six repeats of the design are given in fabric sketch Fig. 160.

**Bindings.**

The same are made either plain or figured, or produced by means of fancy colorings. With reference to figured effects it refers to the combination of two or more weaves. Fig. 163 illustrates subject, showing a broken steep twill used as a centre stripe upon a fabric otherwise interlaced by taffeta weave.

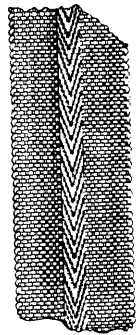


Fig. 163

ARRANGEMENT OF PATTERN.

13	double ends weaving plain
5	" " twill <i>down</i>
1	" end point thread
5	" ends twill <i>up</i>
13	" " weaving plain

—  
37 double ends in repeat.

### **Producing Figures in Smooth Ribbons.**

#### PREPARING THE SKETCH.

The first step to be taken by the designer is to prepare a sketch (actual size) showing the design as it is to appear in the fabric. To do this, besides having a talent for drawing (sketching) he must have a knowledge of the principles of fabric structure, covering single cloth, as well as 2 or more ply in all their varieties. He must also know how to judge quality and counts of yarns, fabric textures, blending of colors to produce pleasing effects, *i. e.*, have a thorough knowledge of the manufacture of ribbons from the yarn to the finished fabric.

#### TO TRANSFER SKETCH ON THE POINT PAPER.

After the sketch has been made, ascertain the proper dimensions the latter has to cover on your point paper; then reproduce the heavy ruled squares of your point paper (in proper reduction) on sketch.

If, for example, the fabric is to be constructed with an even texture for warp and filling and calls for 64 warp-threads in its width (not taking any selvage into consideration) and we use 8 by 8 point paper, said 64 warp-threads then call for 8 heavy ruled squares. In this case, divide *the width* of your sketch into 8 uniform parts and over-rule your sketch, *warp ways*, with 7 lines, each line representing one of those heavy ruled lines (lengthways) on your point paper. Next square-off sketch lengthways, corresponding to dimensions used previously widthways, producing in this way, a check corresponding to those heavy ruled over-checks you have on the point paper.

Next transfer sketch in outlines upon your point paper, being guided in this work by the squares on your sketch and the heavy ruled squares on your point paper. Be careful to use a good free-hand in drawing so as to reproduce a nice outline in pencil to the design on the point paper. Next paint in the figure effects of the design on the point paper with a vermil-

lion (water color) that will permit washing out, in case of a mistake being made.

#### HOW TO CALCULATE THE POINT PAPER TO USE.

Since the design on your point paper must be an exact enlargement of the design in the ribbon, if dealing with a single cloth structure, the proportion of warp-threads to picks per inch must correspond in proportion to the rows of squares representing warp-threads and picks in one of the heavy squares of the point paper you are to use. This is the reason why point paper is made in all varieties of rulings; for instance, we meet paper ruled 8 by 6, 8 by 7, 8 by 8, 8 by 10, 8 by 12, 8 by 16, etc., the difference between the two mate numbers quoted indicating the difference in warp and filling texture in the fabric.

*For Example:* Ascertain point paper to use for a ribbon, having a texture of 120 warp-threads and 150 picks.

Using 8 for a basis of the ruling of the warp, in ascertaining ruling of point paper wanted, we proceed thus:

$$120 : 150 :: 8 : x$$

$$150 \times 8 = 1200 \text{ and}$$

$$1200 \div 120 = 10.$$

*Answer:* 8 by 10 is the point paper to use.

If using 10 for the basis of the ruling, the calculation then will be thus:

$$120 : 150 : 10 : x$$

$$150 \times 10 = 1500 \text{ and}$$

$$1500 \div 120 = 12\frac{1}{2}$$

This will give us 10 by 12½ as an answer. This point paper does not exist (no half numbers possible) hence we must use 20 by 25 point paper; if the same is not in the market you then will have to use 10 by 12 (a common size met with) and enlarge your sketch (in proportion to the difference of the wrong ruled paper you are using) filling ways, when transferring the same onto the point paper.

If dealing with ribbons made with 2 systems of warp (one of which is the figure warp, the other the ground warp) and 1 system of filling (and which must be ground) then consider only the proportion of texture between figure warp and filling in ascertaining the ruling of your point paper wanted.

If dealing with ribbons made with 3 systems of warp (2 systems figure warp and 1 system of ground warp) and 1 system of filling (and which must be ground) then consider the threads per inch of both figure warps (added) to that of the picks per inch, in calculating for the ruling of your point paper wanted.

If dealing with ribbons made with 2 systems of warp and 2 systems of filling (one figure one ground for warp and filling) calculate the same as for single cloth structures, either taking both systems of warp and filling into consideration, or only one.

*Example:* Ascertain point paper to use for a ribbon to be made with 2 systems of warp and 1 system of filling; containing 72 figure warp-threads (ground warp-threads not to be considered) and 48 ground picks to the inch. The proportion of the texture then is 72 : 48, or 3 : 2. This then will call for a point paper ruled 12 : 8, *i. e.*, a point paper in which the heavy squares are ruled-off one way with 11 light lines and the other way with 7 light lines, *i. e.*, each heavy square contains 12 rows of squares one way (for warp) and 8 rows of squares (for filling) the other way.

*Example:* If the ribbon in question calls for 40 (figure) warp-threads and 32 (ground) picks to the inch, this texture of 40 : 32 then would call for a point paper ruled 10 : 8, using the ruling in 10's for the warp and that in 8's for the filling.

Provided the texture of a ribbon calls for a point paper not met with in the market, use in that instance, as illustrated previously, the point paper nearest in proportion to it you can procure. For instance, provided a fabric structure should call for a point paper

17 : 11 to use, you will not be able to procure this paper except you have it made to order. The nearest point paper then to use, and of which there is a constant supply, is either 10 : 6 or 8 : 5, giving in this instance the latter (closer to fabric texture) the preference.

To prove which paper is most suitable to use: Multiply the smallest number of the fabric texture with the largest number of the point paper, and the largest number of the fabric texture with the smallest number of the point paper you have on hand, or can procure. The nearer these two sums correspond, the more suitable the paper. If the ruling of the paper corresponds with the texture of the fabric, both sums will be equal.

Using previously given fabric texture (17 : 11) for illustrating subject, we then find the following calculations:

Fabric texture 17 : 11 in connection with point paper 10 : 6 gives us ( $10 \times 11 = 110$ , and  $6 \times 17 = 102$ ) the sums of 110 and 102, *i. e.*, a difference of 8 points.

Fabric texture 17 : 11 in connection with point paper ruled 8 : 5 gives us ( $8 \times 11 = 88$ , and  $5 \times 17 = 85$ ) the sums of 88 and 85, *i. e.*, a difference of 3 points only.

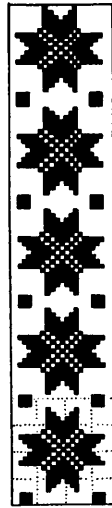
This explains that the latter point paper, *i. e.*, the paper ruled 8 : 5 is more suitable to use, since the difference in points is only 3, compared to that of the first paper and which figured 8 points difference.

This proportion of ruling point paper, expressed by means of a *colon*, can also be expressed technically by means of a *multiplication sign* or the letter *x*, or the word *by*, as shown—8 : 5, or  $8 \times 5$ , or 8 x 5, or 8 by 5, either method of indicating point paper being met with. If using in the construction of a ribbon, 2 systems of figure warp and 1 system of ground warp, in connection with using only 1 system of filling, the following example will explain subject.

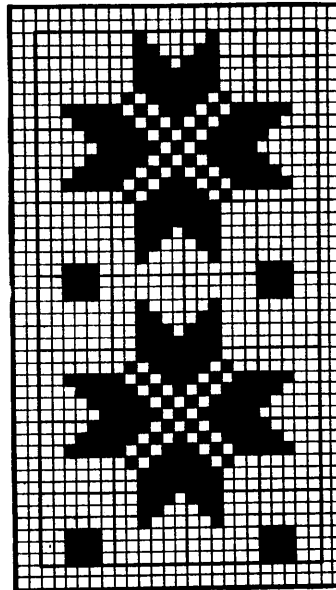
*Warp:* 1 end ground  
 1 " figure, red  
 1 " figure, blue

3 ends in repeat ; 180 ends per inch.

*Filling:* 90 picks per inch.



*Fig. 164*



*Fig. 165*

*Question:* Ascertain point paper wanted.

$180 \div 3 = 60 \times 2 = 120$  figure warp-threads in 1 inch.

$120 : 90 :: 8 : x$

$90 \times 8 = 720$

$720 \div 120 = 6$

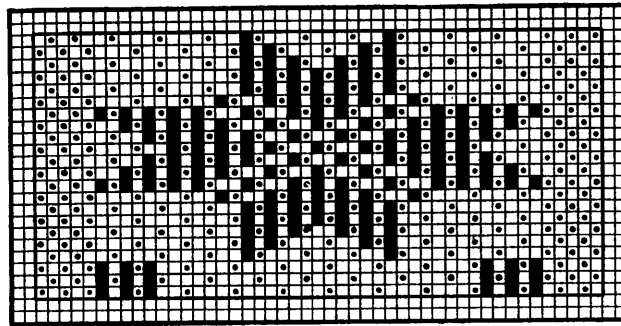
*Answer:* 8 by 6 is the point paper to use.

We will now explain the subject by means of a sketch and its point paper design, showing also the

analysis of the interlacing of warp and filling in the fabric structure.

2 SYSTEMS WARP, 1 SYSTEM FILLING.

Fig. 164 shows us a sketch for a single shuttle ribbon in which the figure is to be produced by means of an extra warp, *i. e.*, 2 systems of warp and 1 system of filling are to be used in the construction of the ribbon. Five repeats of the design are given. The texture of the fabric to be: 25 picks, and 25 ground warp-threads and 25 figure warp-threads per inch, and in the same proportions to fractions of an inch.



*Fig.166*

For this reason, when calculating as to point paper to use, since only the figure warp-threads and the picks come into consideration, the proportion of the texture to be considered is 25 : 25, or point paper 6 : 6, 8 : 8, or 12 : 12 may be used.

The lower portion of the sketch Fig. 164 is shown ruled-off, by means of dotted lines, corresponding to the heavy ruled squares on the point paper—design Fig. 165. The latter shows two repeats painted on 6 by 6 point paper to more clearly illustrate subject. One repeat of it is all that is required to be made; by

the designer for practical work; drawing in draft and harness chain are made out in the usual way.

Fig. 166 is given to illustrate the analysis of figure and ground warp, as they interlace with the filling in the fabric structure. The ground warp is shown by *dot* type, the figure warp by *full* type.

The arrangement of the warp is thus:

4 ends ground	}	19 times
1 end ground		
1 " figure		
4 ends ground		

—  
46 ends, repeat.

It is immaterial what kind of point paper we use for illustrating the interlacing of both systems warp with the filling in diagram Fig. 166, having used for this reason plain point paper, *i. e.*, such as is not over-ruled with heavy squares.

### 3 SYSTEMS WARP: 1 SYSTEM FILLING.

Fig. 167 shows us a sketch for a ribbon calling for two systems figure warp and one system ground warp used in connection with one system filling. One system of figure warp is shown in *black* and that of the other in *gray*. Six repeats of the design are given.

The lower portion of sketch Fig. 167 is shown ruled-off, by means of dotted lines, to correspond to the heavy ruled squares on the point paper design Fig. 168, which shows three repeats in length of pattern. The ground warp-threads are not shown on point paper design Fig. 168; the two figure warp-threads are represented on the same row of squares in a vertical direction, one system in one color (see *full* type) and the other system in another color (see *gray* type). The point paper used is 6 by 6, which means that figure warp-threads (considering the two systems where they appear on one line as one thread) equal in texture the picks.



Fig. 169 shows the interlacing (one repeat) of all the warp-threads with its filling for design Fig. 168.

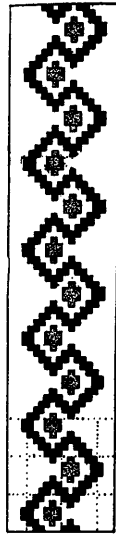


Fig. 167

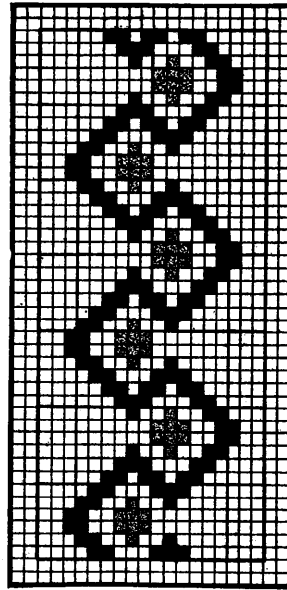


Fig. 168

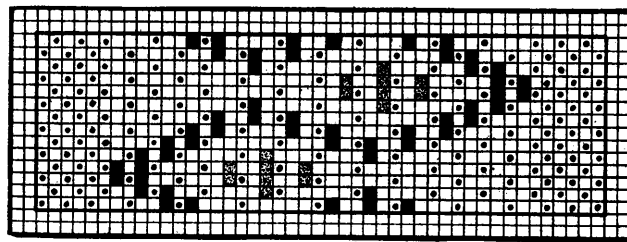


Fig. 169

The ground warp-threads are shown by means of *dot* type, the two figure warp-threads by means of *full* and *gray* type, respectively.

## 1 SYSTEM WARP: 2 SYSTEMS FILLING.

To explain subject let us consider Fig. 164 as the sketch for a fabric, the figure to be produced by means of a special figure pick, in place of an extra figure warp as was done before.

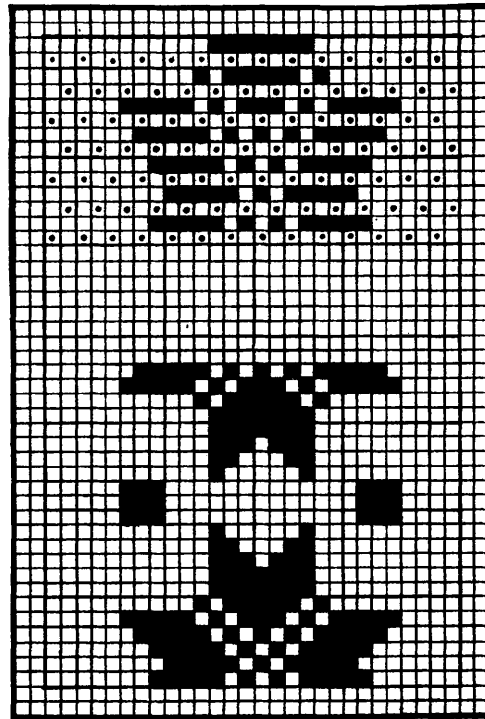
This system of producing figures has the advantage of a saving in yarn, since the pick will only float where so required by the design, whereas in connection with figuring with the warp, said figure threads, where not required on the face, float uselessly on the back. However, using two systems of filling has the disadvantage of having to use a proportionally higher number of picks per inch, with its corresponding increase in cost of weaving, compared to using only one system filling in connection with a figure warp.

The point paper design for ribbons constructed with two systems filling and one system of warp is identical to those where using an extra figure warp in addition to single cloth. This point paper design is then used directly for building the figure picks for the harness chain (or cutting the figure cards in connection with Jacquard work); the weave for the ground picks referring to simple weaves, as for instances, the plain, the 3- or 4-harness twills, or some small, well broken-up granite weave. As a rule, these fabrics are woven *face down* on the loom.

Fig. 170 illustrates the subject, showing at the bottom one repeat of the point paper design and which corresponds to that shown in Fig. 165. The same calls for 22 figure picks, in one repeat of pattern, and for which reason, in connection with the use of the plain weave (22 bars) for the interlacing of the ground picks, 44 bars will be the repeat of the chain, considering the arrangement of ground: figure pick to be as 1:1.

A portion of this chain (14 bars) showing the analysis, *i. e.*, interlacing of the fabric, is given in the

upper portion of Fig. 170, showing the first 7 ground and 7 figure picks; the ground picks being indicated by *dot* type, the figure picks by *full* type, respectively. On account of weaving design Fig. 165 face up and

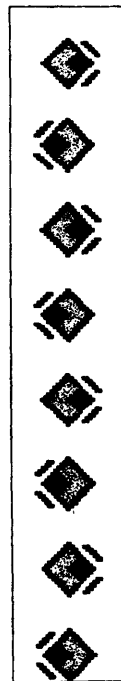


*Fig. 170*

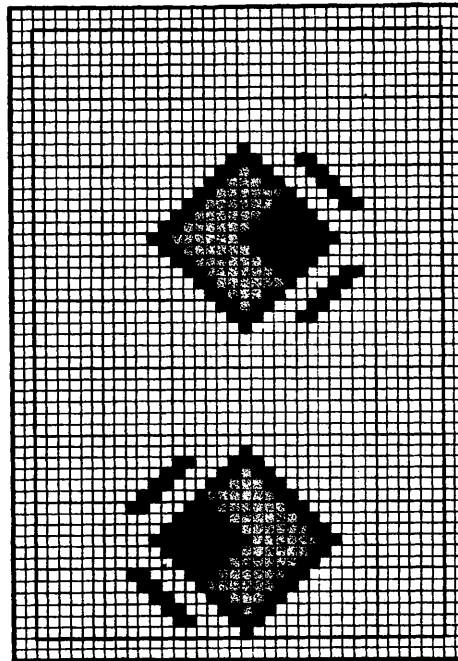
design Fig. 170 face down in the loom, the two designs are identical. If weaving design Fig. 170 face up, read *empty* square for warp up, *full* and *dot* squares for filling up, *i. e.*, warp down.

1 SYSTEM WARP: 3 SYSTEMS FILLING.

Fig. 171 is a sketch for a figured ribbon, to be produced with one system warp (ground warp) and three systems filling, using one system for the ground and two systems for the figure.



*Fig. 171*



*Fig. 172*

Fig. 172 is the corresponding point paper design.

In the loom (weaving ribbon face down) place your ground pick in the lower box, placing in the middle box the filling which has to produce the widest weaving portions of the figure, and in the top box the filling producing the more innermost working portions

of the figure. Provided we would reverse position of these two figure picks, the ends would catch with each other, resulting not only in waste (looping around each other) of yarn, but at the same time producing a useless rigid effect upon the back of the fabric structure, which in this case is considered *up* in the loom. As will be readily understood, two figure picks have to be built for each horizontal row of squares of the point paper design where two colors appear, otherwise only one, considering for one pick *full* type and for the other pick *cross* type for risers. Where only one of these types show on the point paper, as mentioned before, only one figure pick is to be cut.

In connection with Fig. 172, the point paper design (one repeat), the arrangement of the filling is as follows:

1 pick ground	}	× 2
1 " figure (centre box)		
1 " ground	}	× 13
1 " figure (top box)		
1 " figure (centre box)		
1 " ground	}	× 2
1 " figure (centre box)		
11 picks ground		

58 picks, repeat.

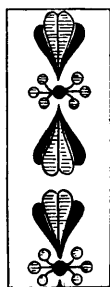
Two repeats of this arrangement of filling produce one repeat of complete weave.

Fig. 173 shows a three shuttle design in which off and on, one or the other figure pick is used. In this instance, place the ground pick in the lower box, in the centre box that figure pick which is used the most, and in the top box the figure pick which is used for the least number of picks.

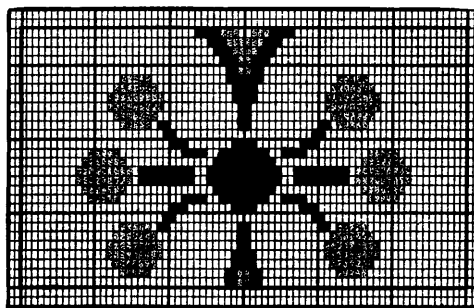
This arrangement of the picks is done to prevent catching of the figure picks, *i. e.*, that they clear each other at weaving. Enter the ground pick first, next enter the first figure pick from left to right to be followed on the next pick with the second figure

shuttle, entering also from left to right. For the fourth pick the ground filling is entered, for the fifth pick the second figure filling, and for the sixth pick the first figure filling (see point paper design 174).

Figure picks entered before the ground pick is entered, are in turn used as the next pick after said ground pick. This will clear the two figure picks and prevent catching of the threads, in turn preventing the formation of ridges on the back of the fabric (which is woven face down) as previously referred to.



*Fig. 173*



*Fig. 174*

In connection with sketch Fig. 173 and point paper design Fig. 174, for example, we considered the texture to be 90 warp-threads and 60 ground picks, to the inch. The various figure picks respectively considered, call for the same number of picks as the ground pick, for which reason the design paper to use is calculated:

90 : 60 or as 3 : 2 giving us either 6 by 4 or 12 by 8 as the paper to use.

THREE SYSTEMS WARP AND THREE SYSTEMS FILLING.

Fig. 175 shows us a portion of a point paper design constructed in this manner and Fig. 176 a portion of its analysis, *i. e.*, plan necessary to be prepared, to either cut from it Jacquard cards or build harness chain for dobbie.

Fig. 175 illustrates figuring with two extra systems of warp and two extra systems of filling, upon a fabric interlaced otherwise with a ground warp and filling.

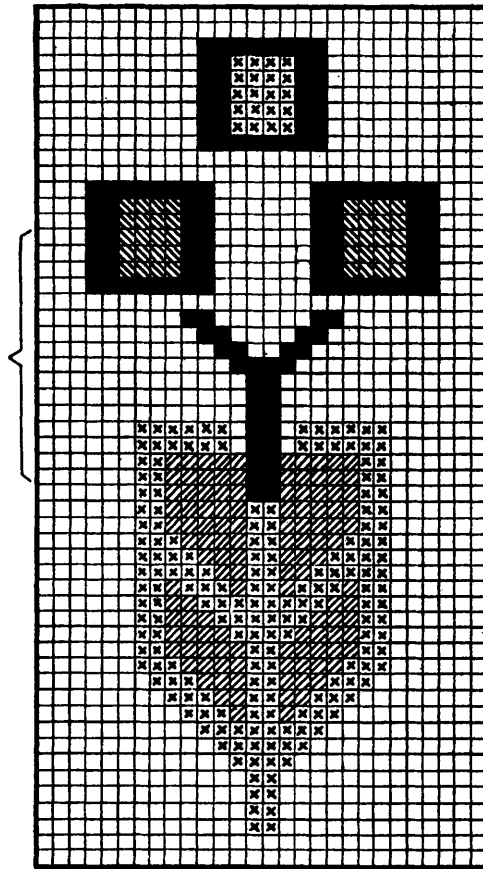


Fig. 175

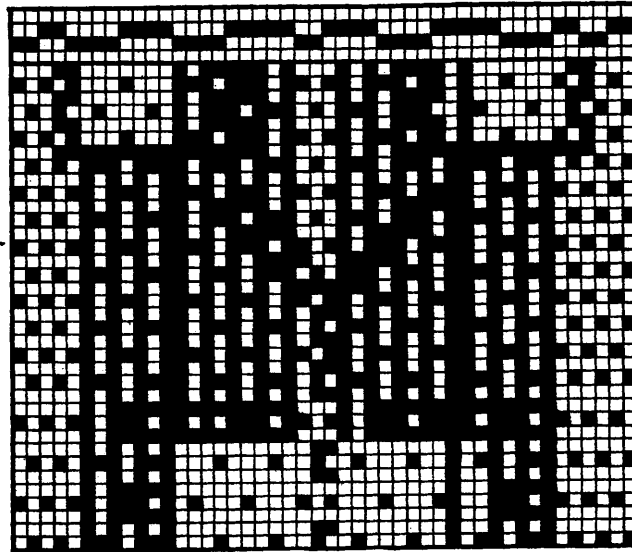
First figure warp is shown by type *shaded* from right to left ( $\searrow$ ).

Second figure warp is shown type *shaded* from left to right ( / ).

First figure filling is shown by *full* type.

Second figure filling is shown by *cross* type.

The design is prepared by painting all the different figure picks (to be inserted between two ground picks) on one horizontal row of squares of the design. In the



*Fig. 176*

same way paint all figure warp-threads as resting between two ground warp-threads, upon its respective vertical row of squares.

Analysis Fig. 176 illustrates the method of interlacing of the 16 lines indicated by the bracket, shown on the left hand side of the design Fig. 175, calling, in its repeat, for the two figure effects, both in warp and filling.



The plan observed in the analysis Fig. 176 is to weave *face down* in the loom. For this reason the formation of the various parts of the design by means of the figure picks, is done by means of raising the respective warp-threads, floating the filling below them; the figure warps, in turn, form parts of the design by means of sinkers in the analysis, *i. e.*, the weave, floating below the picks when so called for by the design.

Above the analysis, the entering of the warp-threads in the reed is shown, the same being thus: 2, 2, 4, 4, 4, 5, 2, 4, 4, 5, 4, 2, 2, 2.

To simplify matters for the reader illustration Fig. 177 has been specially prepared, the same being a duplicate of analysis Fig. 176, executed in crochet type to correspond with design Fig. 175.

In the same the two different filling floats (face down in the loom) are shown by the respective raisers of the warp, being shown in different type, *viz.*, *full* type for one color and *cross* type for the other color. With reference to the two warp effects floating below all filling (*i. e.*, sinkers in the analysis, Fig. 176) the same have been shown in illustration Fig. 177 by type corresponding to the one used in design Fig. 175. See type *shaded* respectively either / or \. This procedure (*i. e.*, indicating raisers and sinkers for a given design) will give us in illustration Fig. 177 the design, as is produced face down in the loom, shown in colors to correspond to such as used in Fig. 175.

Remember that:

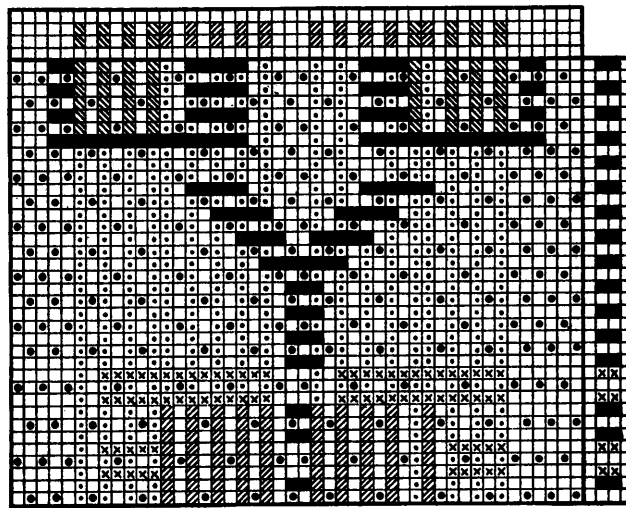
*Full* type shows portions of the design produced by means of raisers, by one of the figure picks.

*Cross* type shows portions of the design produced by means of raisers, by the other figure picks.

*Shaded* (\) type shows portions of the design produced by means of sinkers, by one of the figure warps.

*Shaded* (/) type shows portions of the design produced by means of sinkers, by the other figure warp.

Remember that both kinds of *shaded* type in illustration Fig. 177, with reference to weaving, *i. e.*, interlacing of warp and filling, refer to sinkers, *i. e.*, *empty* type in analysis Fig. 176.



*Fig. 177*

Thus with reference to illustration Fig. 177, if considered as a weave, read:

*Shaded* and *empty* type to be sinkers.

All other style or type (*full*, *cross*, large and small *dots*) to be raisers, and when you obtain duplicate of analysis or weave Fig. 176, shown there in two kinds of type only, *viz*:

*Full* type for raisers.

*Empty* type for sinkers.

The *gamot*, *i. e.*, the plan of arranging the threads as they interlace for the warp is shown on top, and that for the filling at the right hand side of Fig. 177.

The dressing of the warp, according to the *gamot*, is thus:

4 ends ground warp  
 1 end ground warp } 4 times  
 1 " figure warp #1 }  
 1 end figure warp #2 } 5 times  
 1 " ground warp }  
 1 end ground warp } 4 times  
 1 end ground warp }  
 1 " figure warp #2 }  
 1 end ground warp } 3 times  
 1 end figure warp #1 }  
 1 end figure warp #2 }  
 1 end ground warp }  
 1 " figure warp #1 }  
 6 ends ground warp

---

46 ends in pattern

The arrangement of the filling, according to its gammot, given on the right hand side of illustration, reading from bottom upwards, is thus:

1 pick ground }  
 1 " figure #1 } twice  
 1 " figure #2 }  
 1 " ground }  
 1 " figure #2 }  
 1 " figure #1 }  
 1 " ground } 12 times  
 1 " figure #1 }

---

36 picks given in illustration

The weave for the ground structure is the taffeta, see *large dots*. The *small dots* indicate the raising of the two systems of figure warp on any portion of the design where not required to be shown on the face of the fabric structure, which, as mentioned before, in this instance, is woven face down in the loom.

With certain fabrics (galloon-laces, which after weaving are then cut out) requiring several shuttles, we may prefer to weave them face up. In connection with such fabrics, as a rule, entering threads are placed at the cut line, and to have these prominently in view of the weaver, such fabrics are then woven face up in the loom.

#### **Formation of Curved Edges.**

Similar to the formation of pearl edges in ribbons, as explained in connection with Figs. 110 and 111, the filling may be made to form a curved edge, either on one or both sides of the fabric.

Fig. 178 shows us a sketch for a two shuttle ribbon, to be interlaced with the taffeta weave, and presenting a curved edge at the right hand side of the fabric.

Fig. 179 shows us at *a* the point paper design, at *b* the analysis of the interlacing of warp and filling. Two repeats of the design are shown in diagram *a*, whereas only one repeat of the working plan, *i. e.*, of the analysis *b* is given.

The repeat of design *a* (figure picks) calls for 14 picks. The arrangement of figure and ground picks is 1:1, hence gives us 28 picks for the repeat of the analysis *b*.

The curve to the fabric is produced by running the filling around brass wires, threaded into heddles on the harness frames and placed in dents next to the fabric.

*Cross* type indicates six of these wires, working in pairs, two heddles to a harness.

Ground picks are indicated by *dot* type.

The cards are cut, or the chain built, direct from design *a*, no analysis being required. Cut *empty* squares for face up; shown face down in diagrams *a* and *b*.

Every other pick (every uneven number pick in our example) calls for the taffeta, the remaining picks (every even number pick) being figure picks. Two

shuttles are used, one for the ground, the other for the figure.

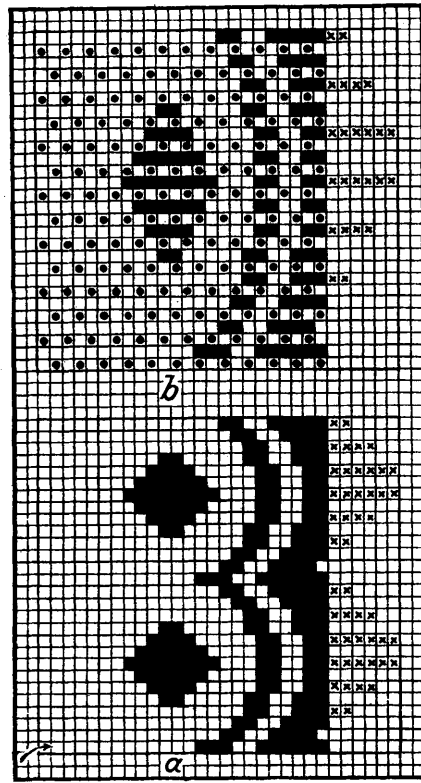


Fig. 179



Fig. 178

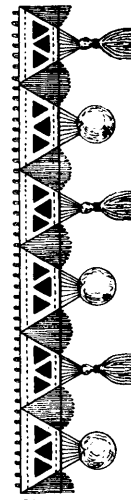


Fig. 180

Considering *cross* type only, *i. e.*, the wires for forming the curved edge produced by the filling it will be seen from design *a* that the figure filling (entering filling from left to right on the first pick, *see arrow*) does not interlace with the wires in picks 1 and 2.

On pick 3 the filling passes from left to right over all wires, being caught in its return pick, *i. e.*, held outside the woven portion of the fabric by the first two wires on pick 4.

Pick 5 same as pick 3.

Pick 6 filling held outside of the woven portion of the fabric by four wires.

Pick 7 same as pick 3.

Pick 8 filling held outside of the woven portion of the fabric by all six wires.

Picks 9 and 10 same as 7 and 8, respectively.

Picks 11 and 12 same as 5 and 6.

Picks 13 and 14 same as 3 and 4.

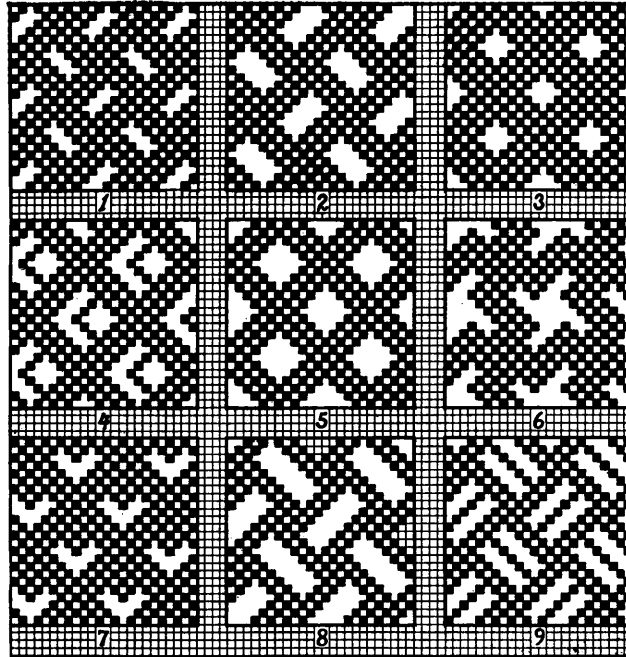
The interlacing of the ground picks, on the edge of the woven part of the fabric, around the loops of the figure picks, will hold the latter in position. The figure pick, being placed on top, in forming the loops works wider than the ground pick, giving the latter a chance to embrace the figure picks, holding, *i. e.*, securing the latter properly every time at every second ground pick, to the woven edge of the fabric.

SCALLOPED, or imitation of embroidery edges, are produced in a similar manner. In this instance, the figure pick interlaces alternately over and below the last edge threads and the nearby placed wires. Said filling thus makes a double loop, which by means of stuffer threads, laid inside, is kept in position. Since these scalloped edges must have the same appearance on face and back, do not have the two systems of filling interfere with each other at weaving, *i. e.*, have them clear the way for each other. For this reason enter from the left two picks ground (as placed low) to be followed with two picks figure (as placed high) entered from the right.

In connection with upholstery trimmings, frequently rather prominent curves of loops are woven, also plain, long loops, *i. e.*, fringes, which afterwards are specially transferred into ornaments, by girls, by hand. Fig. 180 shows a specimen of this work.

**Color Effects in Ribbons.**

**WARP EFFECTS.** The plainest styles are such as used for the trimming of men's hats, being one shuttle cotton ribbons, woven on taffeta. The fancy effect is produced by dressing the warp in sections of differ-

*Fig. 181*

ently colored yarns. Again in connection with figured ribbons we may use a figure warp composed of different colors throughout the repeat, again either system of the figure may be dressed a different color.

Printing the warp is also much used. In this instance, the dressed warps are printed with various patterns, *i. e.*, color effects. Using in connection with such warps a filling not too heavy in count and inter-

laced with taffeta, brings out the printed pattern in a peculiar, less pronounced, manner. To increase the effect, weaves technically known as "figuring with the warp upon taffeta ground" are used for the interlacing of these printed warps. Fig. 181 shows us a collection of nine weaves of this character. In the same, white, or *empty* squares, stand for warp up, *i. e.*, shows the floating figure effect of the printed warp, previously referred to. Black, or *full* type, indicates the filling up.

**FILLING EFFECTS.** These are produced by using more than one shuttle, *i. e.*, using different colors in the filling. Again we may use a printed filling, *i. e.*, have the skein or hank printed in stripes of different colors. Formerly from 2 to 4 colors were printed upon it, whereas now more divisions are made, *i. e.*, more colors printed upon it. Using a fancy color arrangement for warp and filling gives us an unlimited field for a diversity of color effects.

Woven ribbons, both in plain as well as fancy weave structures, are also printed in the finishing process; they are then either printed in solid colors or fancy effects in two or more colors; again watered effects may be desired. Trade marks or names of firms are also printed on ribbons, in imitation of the woven article. Cigar ribbons are always printed.

In imitation of woven printed ribbons, for sake of cheapness, broad woven cloth, after printing, is cut up into the widths of ribbons. The absence of solid selvages will readily show them up, the outside warp threads having no hold in the fabric, they will easily unravel.

#### **Other Effects in Ribbons.**

Raised effects, open work and other special effects are more variedly used in the manufacture of ribbons as compared to any other branch of the textile industry. The cause of it is that with ribbons we deal with small surfaces, giving little opportunity for the designer to show his skill in connection with elaborate, well-distributed, all-over designs, as is of so much



importance when designing for floor coverings, draperies, upholstery goods, dress goods, etc. Having no opportunity to show his skill in that line, the ribbon or narrow ware designer, has to look for other quarters for new ideas. Using all possible kinds of plain and fancy yarns, specialties in manufactured twists, metal yarns, combinations of diversity of weave effects, etc., must give him this opportunity for new styles, and which are constantly required by the trade.

**Preparing the Drawing-in Draft and Harness Chain for Ribbons Figured with One or More Extra Warps.**

USING ONE SYSTEM OF FIGURE WARP.

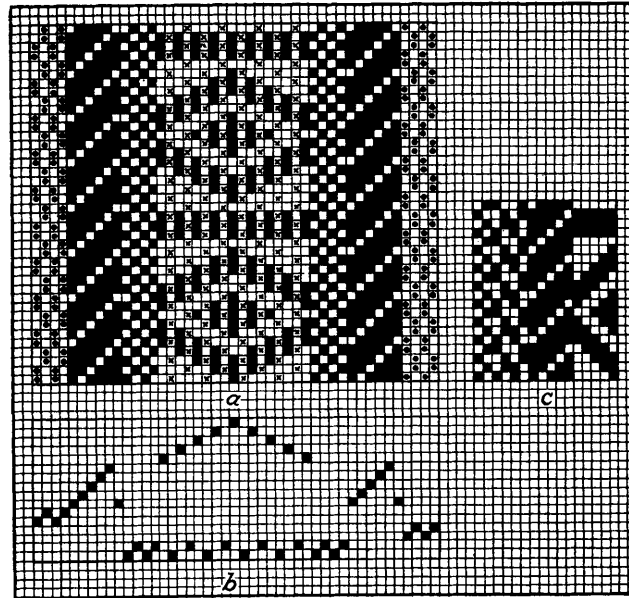
Fig. 182 shows us at *a* the weave for a figured ribbon (one shuttle work), showing rib edges, twill stripes and a figure effect in the centre, produced by an extra warp upon a taffeta ground. Repeat of weave 45 warp threads and 20 picks.

In examining this rib edge, *i. e.*, selvage of the ribbon, you will notice that the starting of up and down of the  $\frac{2}{2}$  4 pick rib weave is different on both sides (one pick difference). This must be done every time such a rib edge is used, being careful to enter the filling at the same time from the proper side of the ribbon (from the left on first pick in our example). A mistake, *i. e.*, wrong positioning of the shuttle, or wrong placing of the rib weave, would be the cause of the filling pulling out of the rib edge, also out of a portion of the twill effects in our example.

Below the weave (see *b*) is given the drawing-in draft, calling for a 16-harness fancy draw. In the same we have placed the warp-threads interlacing the most (the plain weave) nearest to the reed (*i. e.*, on harnesses 1 and 2); the rib selvage and which is the next tightly interlacing weave is put next to the plain (*i. e.*, on harnesses 3, 4, 5, 6); the  $\frac{4}{1}$  5-harness twill is drawn next on harnesses 7, 8, 9, 10 and 11, followed with drawing the extra figure warp-threads, and which interlace very loosely, on harness 12 to 16, inclusive.

This method of drafting the warp-threads is done according to

*Rule:* For forming the shed the harnesses must be raised in proportion, always higher the further in back from the reed, the one nearest the reed being



**Fig. 182**

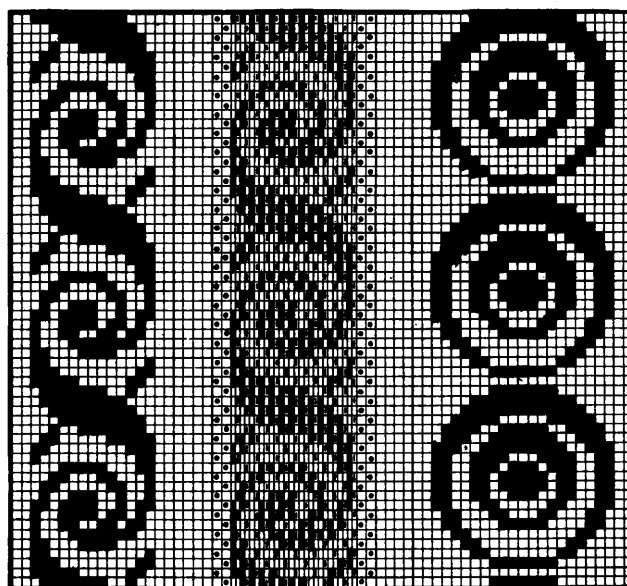
the one raised the least. For this reason place the threads which interlace the most, hence have to stand the most strain during shedding, on the harnesses raised the least high, *i. e.*, nearest to the reed.

The harness chain is shown at *c*, calling for 16-harness and 20 picks, obtained from weave *a* and its drawing-in draft *b* by

*Rule:* Indicate the working of each harness (throughout one complete repeat of the weave) only the first time when called by the drawing-in draft.

SUGGESTIONS FOR STRIPES.

Fig. 183 to and inclusive Fig. 198 show a collection of floral and geometrical designs prepared for these ribbon centre stripes, calling in every instance for one



*Fig. 183*

*Fig. 184*

*Fig. 185*

system of figure warp used in connection with the regular system of ground warp, whereas designs Figs. 199, 200 and 201 call for two systems of figure warp used in connection with the regular ground warp. One system of filling is called for in every instance. These stripe effects refer to similar figure warp-threads as are shown in weave Fig. 182 to occupy then five rear harnesses 12 to and including 16; the new collection will require more than five harnesses in the loom.

Suitable plain or figured work (single cloth) is to be provided for each side of each figure stripe (not shown in designs Figs. 183 to 201) the same as were used in connection with weave Fig. 182, respectively then the plain, twill and rib weave. Other weaves may be used in place of the twill and rib weave shown, the plain weave to be always more or less retained.

Fig. 183 shows a stripe effect calling for 13 warp-threads and 20 picks in repeat of pattern. *Full* squares show the floating of the extra warp on the face of the fabric.

Fig. 184 shows the analysis for design Fig. 183, *i.e.*, the plan for the interlacing of ground and figure warp-threads with its filling.

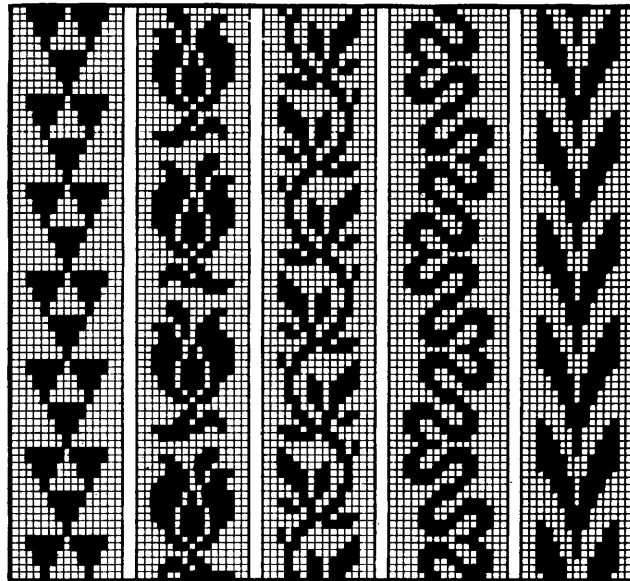
The plain weave has been selected for interlacing the ground structure (see *dot* and *dash* type) *dot* type being used where no figure warp comes under consideration in the construction of the fabric, whereas *dash* type is used where one figure warp-thread alternates with one ground warp-thread to produce the design. To retain the effect of the design in the fabric in its corresponding shape in our analysis Fig. 184, we prepared the point paper for this figure warp by dividing each square lengthways in half so as to imitate its fabric texture.

Suppose texture of ground warp and filling is 80 by 80, then in every instance where the extra warp comes into consideration the proportion of the texture in that part of the ribbon changes to 160 by 80.

Fig. 183 is the working design. The weave for the ground cloth (the plain weave in this instance) is built direct on the harness chain and distributed by means of the proper drawing-in draft used over the lay-out of the ribbon in the loom, as was done previously in connection with weave Fig. 182<sup>a</sup> by means of drawing-in draft *b* and considering harness chain *c*. The figure calls for 13 warp-threads in its repeat, and since every

thread interlaces different, requires 13 harnesses for its execution on the loom.

The weave for the ground cloth calls for 2 or 4 harnesses; using (preferably) the latter number so as to more equalize the number of warp-threads for each



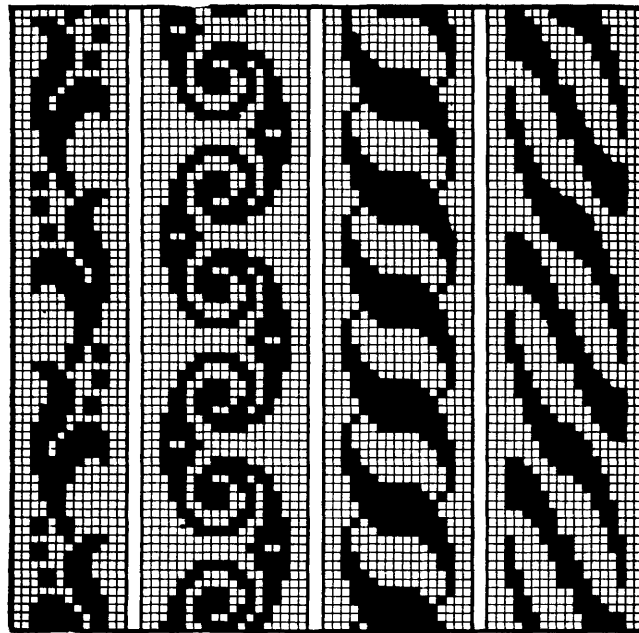
**Fig. 186    Fig. 187    Fig. 188    Fig. 189    Fig. 190**

harness gives us 17 harness for weaving the complete fabric on the loom, provided no outside fancy effect, *i. e.*, another weave or weaves than the plain is or are added.

Design Fig. 183 may be used as a small single stripe effect, or in connection with wider ribbons two of them may be used as one stripe. Again the position of the second effect then can be reversed, *i. e.*, the design turned over by means of using for it (the second effect) a point draw (without increasing the number

of harnesses) producing in turn another combination of a stripe effect.

Fig. 185 has for its repeat 19 warp-threads, calling



**Fig. 191      Fig. 192      Fig. 193      Fig. 194**

for a 9-harness point draw with 3 ends alike for the point. If using two of these effects side by side for one stripe effect in the ribbon, you may *drop* the second effect 10 picks. This will call for 9 additional harnesses, *i.e.*, 18 harnesses would be required for the combination stripe, plus the 2 or 4 harnesses for the plain weave for ground, or any other weave that you care to use.

We will now briefly refer to the other designs.

Fig. 186: Repeat 11 warp-threads calling for a 6 harness point drawn on the loom.

Figs. 187 and 188: Repeat 11 warp-threads, calling for a straight draw of 11 harness on the loom.

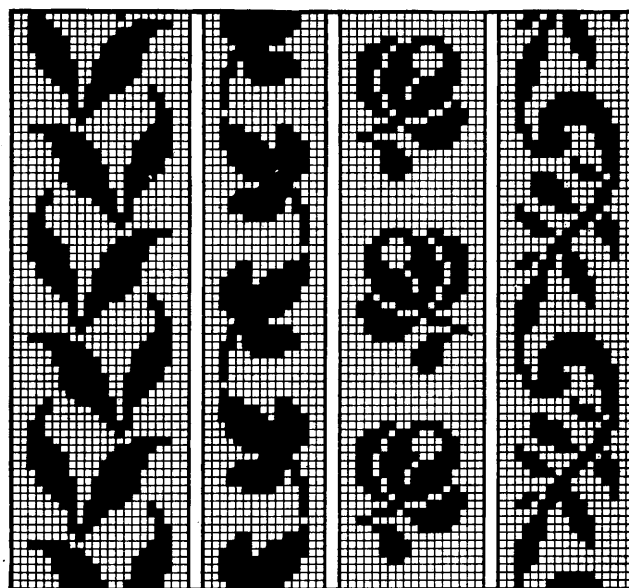
Fig. 189: Repeat 12 warp-threads, straight draw.

Fig. 190: Repeat 11 warp-threads, 6 harness, point.

Fig. 191: Repeat 9 warp-threads, straight.

Fig. 192: Repeat 15 warp-threads, to be preferably drawn on 15 harness straight, or if necessary on 14 harness, by drawing twice in rotation on harness 7.

Fig. 193: Repeat 13 warp-threads, to be drawn on 9 harness, drawing five times in rotation on harness 5.



*Fig. 195*

*Fig. 196*

*Fig. 197*

*Fig. 198*

Fig. 194: Repeat 14 warp-threads; can be drawn on 13 harness if this is necessary, by drawing two ends in rotation on harness 7.

Fig. 195: Repeat 18 warp-threads, straight.

Fig. 196: Repeat 11 warp-threads, straight.

Fig. 197: Repeat 14 warp-threads, straight.

Fig. 198: Repeat 13 warp-threads, straight.

Fig. 199 shows us a two color effect in part of the design; one color of the figure effect is shown by *full* type, the other by *shaded* type.

Fig. 200 is an analysis showing the interlacing of both systems of figure warp with its ground warp. So as to again keep the analysis conforming in its general appearance to that of Fig. 199, the vertical rows of squares on the point paper were ruled off in their centre wherever one figure warp-thread (only) came into consideration, whereas where two figure warp-threads (see *black* and *shaded* squares on one vertical row of squares on design Fig. 199) come into consideration we then divided the respective square of the regular point paper lengthwise into 3 parts, the original square thus taking the place of 3 warp-threads (one ground, one figure color #1, one figure color #2).

Considering the analysis in detail we find the following arrangement used for the warp:

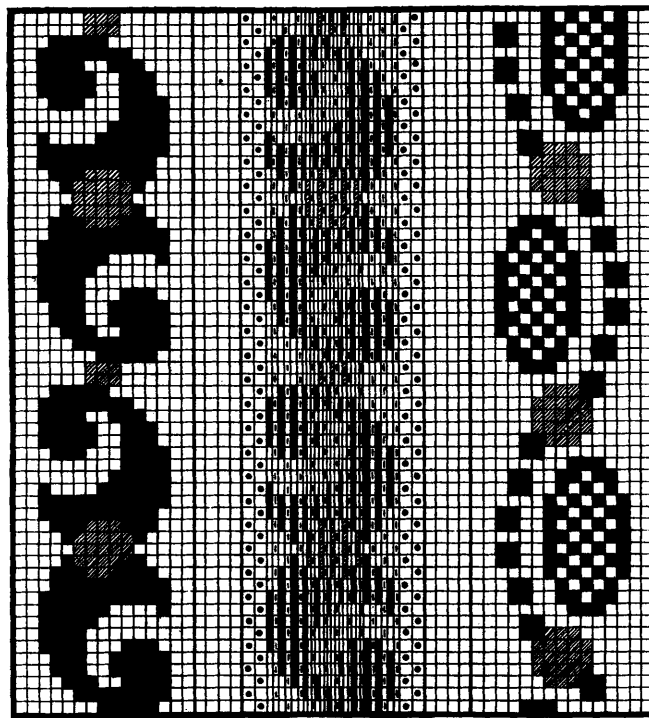
2 warp-threads shown by *dot* type interlace single cloth with the plain weave.

The next 6 warp-threads show figure and ground warp arranged 1: 1; see *full* and *dash* type respectively.

The next 15 warp-threads show two sets of figure warp-threads working as mates to one ground warp-thread. Figure warp-threads are shown by *full* and *shaded* type, ground warp-threads by *dash* type. It will be readily seen that where *full* type is up, its mate (*shaded*) thread is down and vice versa; in some instances both colors are down and then the ground warp (see *dash* type) takes the place of the face of



the fabric, interlacing with the filling on the plain weave, both figure warp-threads then floating on the back of the structure.



*Fig. 199*

*Fig. 200*

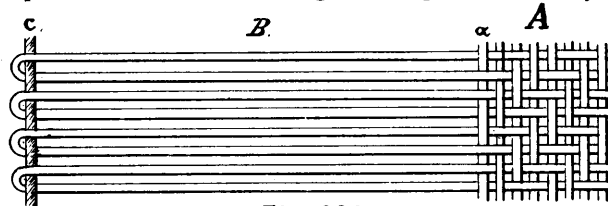
*Fig. 201*

Fig. 201 shows another effect produced partways with two colors besides the ground structure, shown by the same arrangement of type as in design Fig. 199, and when explanations before given also refer to this design.

**Fringes and Pearl Edges.**

## FRINGES.

In some instances trimmings are made with fringes, the latter, after being woven, being knotted by hand, again a regularly woven fringe may be all that is required. Fabric sketch Fig. 202 explains the subject.

*Fig. 202*

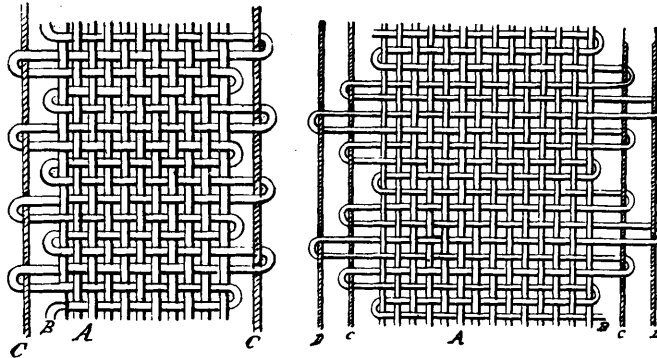
In the same *A* indicates the body portion or heading of the fabric which may be of any width and interlaced by any kind of weave, plain or figured, single cloth or using one or two extra systems of warp for figuring; we used the plain weave in our example. *B* is the fringe, produced by placing a wire *C* some distance apart (as regulated by the length of the fringe required) parallel with the warp-threads through a dent of the reed. This wire is fastened to some of the back parts of the loom and extends in front for some of the length of the woven fabric, out of which it pulls itself automatically while the fabric in passing through a pair of take-up rollers from where it is automatically delivered into a receptacle as placed below the loom. In place of a wire a common heavy count of cotton yarn may be used, the same then weaving as a regular warp-thread throughout the entire length of the fabric, being afterwards pulled out of fringe. Either wire or warp-thread *C* interlaces on plain weave, *i. e.*, one pick up, one pick down and thus catches the filling for forming the fringe.

## PEARL EDGES.

The selvages of ribbons and trimmings are sometimes formed with loops, either in a straight line or variegated. They are called pearl edges and are pro-

duced by means of temporarily interlacing the filling around horsehairs or wires as was explained before in connection with fringes, or using heavy cotton threads in place of it throughout the weaving of the ribbon, liberating the cotton thread after the fabric has left the loom. To illustrate subject of constructing these pearl edges to ribbons, the four illustrations Figs. 203 to 206 are given. In the same letters of references indicate thus: *A* the warp-threads for the ribbon; *B* the filling; *C, D, E, F, G* wires, horsehairs, or regular heavy counts of cotton yarn as previously referred to.

Fig. 203 shows a one size loop produced first on one side and then on the other side of the ribbon, using one horsehair *C* for this purpose.



*Fig. 203*

*Fig. 204*

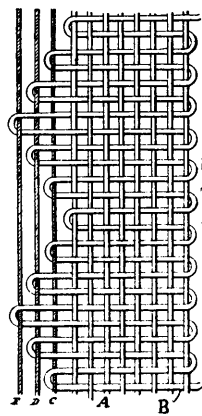
Fig. 204 shows 2 different sizes of loops, produced by using 2 horsehairs, wires or waste cotton threads *C, D* on each side of the ribbon.

Fig. 205 illustrates three different sizes of loops only on one side of the ribbon or trimming, produced by three horsehairs, wires or waste cotton threads *C, D* and *E*.

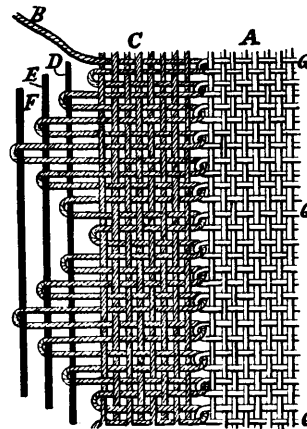
In a similar way Fig. 206 shows the formation of five sizes of loops formed on each side of the ribbon

by using five horsehairs, wires or waste cotton threads *C, D, E, F* and *G*.

By reference to Figs. 110 and 111 the influence of



**Fig. 205**



**Fig. 207**

the twist imparted to the filling, *i.e.*, to the loops as formed, has been shown.

#### TWO COLOR EFFECTS.

The object is to impart to a trimming a different colored edge compared to that of the body portion. Fig. 207 illustrates the subject and in which the portion of warp and filling shown in outlines, *i.e.*, white, refers to the threads that form the body portion of the fabric, the differently colored edge being shown by shaded effect in the diagram. The latter is produced by placing a special warp-thread on a small bobbin and allowing it to work with very little friction near the edge of the fabric. Have this special warp thread work "one pick up and one pick down," so that the filling passes alternately above and below. The tension for the filling must be more than the one for the warp-thread, thus the filling, when returning into the main structure, will pull the special warp thread closely up to the body of the fabric; producing in this

manner the required effect, *i.e.*, a different colored fringe compared to that of the body of the fabric.

If interlacing the fringe with the  $\frac{2}{2}$  rib weave, *i.e.*, 2 picks in a shed, the special warp-thread will get drawn in through fringe and to the body part of the fabric, as shown in illustration Fig. 107. In the same, letters of reference represent thus:

- A, the warp for the body of the fabric;
- B, the special warp for forming the different colored fringe;
- C, the warp-threads for the fringe, which may be corresponding in color to that of the special warp B;
- D, E, and F, three wires, horsehairs or threads of yarns for forming different sized loops (*i.e.*, pearl edges in this instance) to the edge of the fringe;
- G, the filling for the body of the fabric.

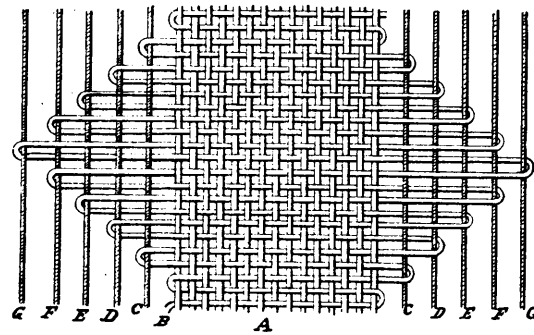
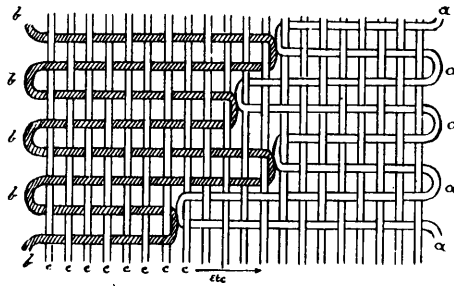


Fig. 206

Figs. 208 and 209 show the construction of trimmings produced by means of using two colors in the filling.

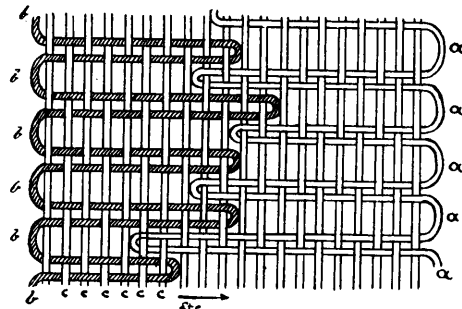
Fig. 208 shows the arrangement of the filling to be 1:1, *i.e.*, one pick *b* shown shaded, to alternate with one pick *a* shown in outline. *c* indicates the warp, shown also in outline. The interlacing of the latter is thus: first pick *b* entering from the left  $\frac{1}{1} \frac{1}{1} \frac{1}{1} \frac{1}{1}$

The next pick is *a* entering from the right, the warp formed being  $\overline{1} \overline{1} \overline{1} \overline{1} \overline{1} \overline{1} \overline{1} \overline{1} \overline{1} \overline{1}$ . Pick 3 is again *b*, which now was on the right hand side of the fabric, and thus is introduced from right to left in the



**Fig. 208**

structure, the warp reading  $\overline{1} \overline{1} \overline{1} \overline{1} \overline{1} \overline{1} \overline{1} \overline{1} \overline{1} \overline{1}$ . The fourth pick is again *a*, which now was on the left hand side of the fabric, and enters the latter from left to right, the warp reading  $\overline{1} \overline{1} \overline{1} \overline{1} \overline{1} \overline{1} \overline{1} \overline{1} \overline{1} \overline{1}$ :

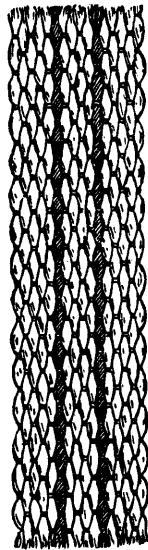


**Fig. 209**

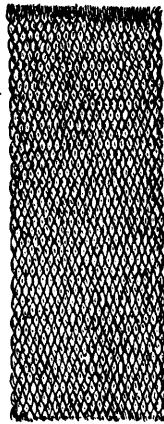
From explanation given the interlacing of the trimming shown in Fig. 209 will readily explain itself, two picks *b* shown shaded, alternating with two picks *a* shown in outline. *c* indicated the warp-threads.

**Lamp Wicks.**

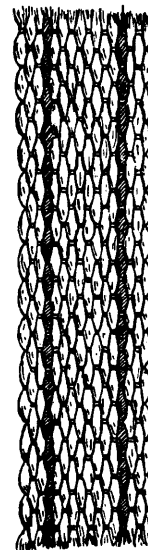
The same refer to another kind of narrow ware fabric, and may be divided into double cloth structures united by means of a special binder warp, and such as interlaced on the "hose" principle. Some wicks are also made on braiding machinery.



*Fig. 210*



*Fig. 214*



*Fig. 213*

**USING A BINDER WARP.**

Lamp wicks thus made are designed for the use of flat flame burners and in their general appearance resemble a heavy, coarse, cotton ribbon, the principle observed in the manufacture of these wicks, as well as in the other kind (hose) being to use a more or less loose twisted warp, so as to give to the wick as much absorbent power as possible, in order to freely transfer the oil from its reservoir to the flame. This will also explain why by preference we are using a

double cloth structure for these flat flame wicks, since by means of them the oil will rise more readily and besides a broader surface flame (2 fabric structures actually side by side) will be the result than if single cloth structure was used.

These flat wicks are made in various widths, from  $\frac{3}{8}$  inch to 1 inch being average sizes most frequently used; however, wider sizes are met with, also in some instances narrower wicks.

Diagram Fig. 210 gives an illustration of a standard wick.

Fig. 211 shows the weave required for producing this structure, the same repeating on 38 warp-threads and 4 picks; the lowest number of harnesses necessary to weave this wick is five.

Examining the weave we find the same to be the regular double plain, stitched every fifth thread with a binder warp-thread interlacing with the common plain weave, and which stitches (unites) the two single cloth fabrics into one structure. Face and back warp can come from one beam or bobbin, whereas the binder warp-threads (on account of their closer interlacing) will take up more, hence must come from a different beam or bobbin.

To more clearly show the construction of the weave with reference to its fabric sketch, diagram Fig. 212 is given, showing the various warp-threads indicated thus:

*Hatched* type = light face warp,

*Cross* type = light back warp,

*Dot* type = binder warp,

*Full* type = dark face warp,

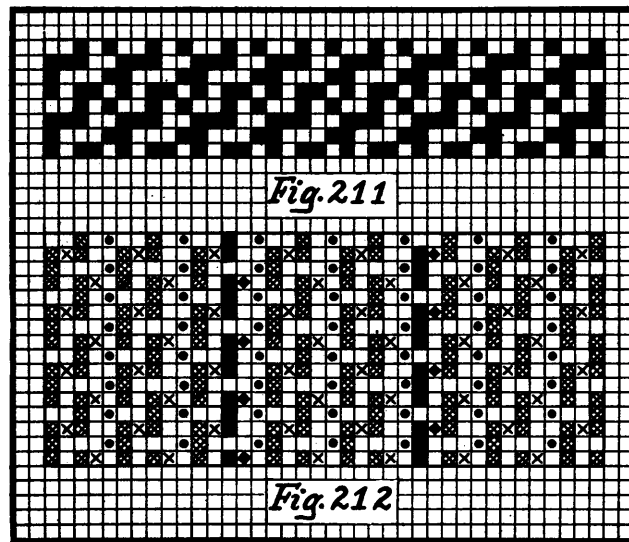
*Diamond* type = dark back warp.

These wicks are made either all in the grey or with stripe effects as shown in fabric sketch Fig. 210. *Full* crochet type in diagram Fig. 212 shows these two line effects as shown on face of fabric sketch Fig. 210, whereas *diamond* type indicates its mate stripes on the back of the wick (not shown).



Fig. 213 shows another stripe effect, showing the two line effects placed farther apart from each other. Fig. 211 is the weave used. The only difference is in the placing of the four dark warp-threads, *i. e.*, in the color arrangement of the warp.

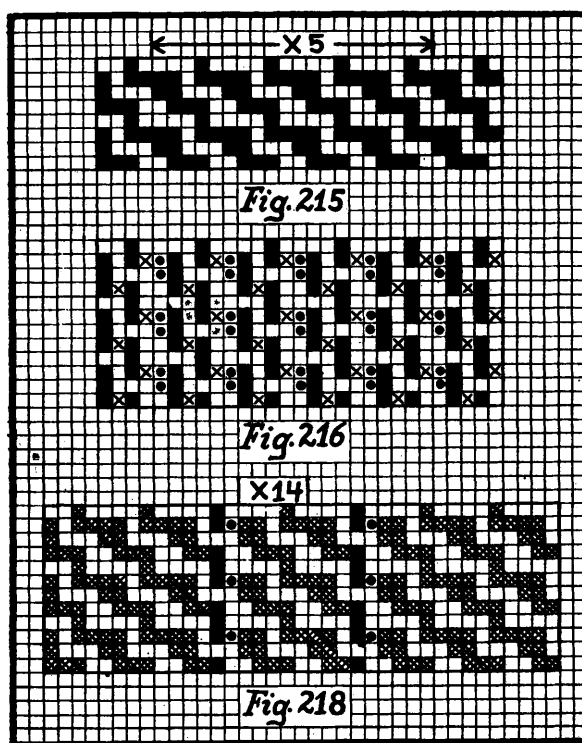
A different fabric structure of a lamp wick than those previously referred to is shown in connection



with illustrations Figs. 214 to 218, the same referring to a more closely set warp texture compared to the former structures. In this instance it would be impossible to use the plain weave for binders, using in place of it the  $\frac{2}{2}$  4-harness twill for this purpose, *i. e.*, using only one half the number of interlacings of said binder warp in a given number of picks.

Fig. 214 shows such a lamp wick and Fig. 215 the weave for producing the former. Fig. 216 is the analysis for said weave, *viz.*:

*Full* type = face warp,  
*Cross* type = back warp, and  
*Dot* type = binder warp.  
 Repeat of weave, 109 warp-threads and 4 picks.



A fancy color effect for such a wick is shown by means of fabric sketch Fig. 217 and its weave Fig. 218. The latter is shown in different crochet type to simplify color effect shown in fabric sample.

Repeat of weave, 102 warp-threads and 4 picks;  
 width of fabric, 1 inch; *shaded* type indicates white,

*i. e.*, grey warp in the fabric; *full* type indicates fancy face warp-threads 13 and 88, whereas *dot* type indicates fancy back warp-threads 14 and 89, not shown in illustration Fig. 217.

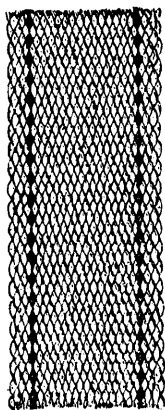
#### DOUBLE CLOTH STRUCTURES KNOWN AS HOSE.

This kind of lamp wicks are known as "wicks for round burners," and in their common construction are nothing more than fabrics interlaced with the common double plain weave, using either a 2, 3 or 4 fold 2-ply thread for each warp-thread of the weave in connection with a 2, 3 or 4-ply filling. Both the upper and lower cloth interlace with the plain weave, the filling alternately passing in the upper and then in the lower cloth structure.

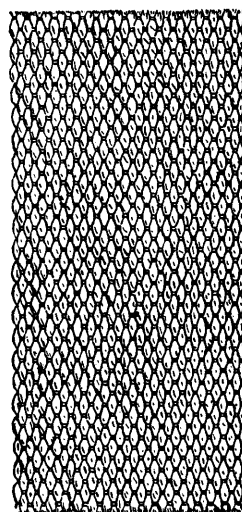
It is well to mention that for these round wicks an uneven number of warp-threads must be used, for example, 55 warp-threads, and when 28 warp-threads are used for the upper structure and 27 for the lower structure; this arrangement prevents two warp ends (at the edge) from running together (interlacing with the filling alike) and in turn form an imperfect connection. The threading of the reed must also be taken into consideration. For example, in connection with a texture reeded 4 ends per dent use at either edge only 2 ends per dent and in the next dent draw 3 ends, previously to reeding all the way 4 ends per dent. Do the same also on the other side of the fabric. Using less ends per dent at both edges of the fabric is necessary to be done for the fact that at these places the filling during weaving is interlacing tighter (more tension) and that in turn the warp-threads there are pulled more closely together as compared to the remainder of the fabric.

Fig. 219 shows such a wick, calling for its execution at the loom for the following particulars: Warp-threads for upper structure 34, four fold 2-ply cotton. Warp-threads for the lower structure 33, four fold 2-ply cotton. 25 picks per inch in loom, using a 4-ply filling.

The width of these lamp wicks can be either increased or decreased, conforming to the size of the burner;  $1\frac{1}{8}$  inch to  $2\frac{1}{2}$  inch wide structures (on the loom) being fair average sizes met with.



*Fig. 217*



*Fig. 219*

#### FANCY STRUCTURES IN ROUND LAMP WICKS.

The first affair refers again (the same as explained in connection with flat lamp wicks) to fancy striping by means of fancy (mostly blue) warp-threads used, to suit a stripe effect required. Mostly it will be one fancy colored thread introduced in the centre of each structure, *i. e.*, one thread for the upper structure and the joining end in the weave of the lower structure; again the striping may be done only in connection with one of these structures. Whichever may be the case, explanations given in connection with the striping of flat wicks will readily explain the subject.

In connection with some round burner lamps, wicks are required which for a portion of their length (about for one half) are not hose.

Fig. 220 shows such a lamp wick, the same being from *a* to *b* true hose, from *b* to *c* open on one side.

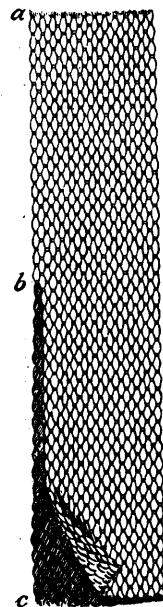


Fig. 220

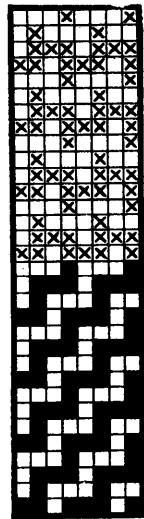


Fig. 221



Fig. 222

It then follows that in the portion of the fabric from *a* to *b* double plain 1:1 in the filling is used, whereas in the portion *b* to *c* double plain 2:2 must be used; in other words in the portion *a* to *b* of the fabric the shuttle travels alternately first through one structure and in turn through the other structure, whereas in the portion *b* to *c* of the fabric, the shuttle

travels to and fro, first both ways in one structure and next in the other structure, in this manner only uniting the structure at that edge where the shuttle changes from one structure to the other, the other edge of the structure being left open on account of the shuttle returning in the same (upper or lower as the case may be) structure of the fabric. In order to better explain the subject weave Fig. 221 is given. In the same the portion of the weave shown by *full* type (see *a* to *b*) shows the formation of *full hose* weaving; portion of weave shown by *cross* type (see *b* to *c*) shows the formation of *split hose* weaving, as we may call it.

It will be readily understood that the 16 picks of each style of weaving (full or split hose) as shown in connection with weave Fig. 221, are any number of times duplicated, previously to changing to the mate system of weaving; the affair in connection with fabric structure Fig. 220 referring to: length of wick 6 inches; full hose 3 inches, split hose 3 inches; picks per one inch = 30, thus  $30 \times 3 = 90$  picks full hose (as shown by means of *full* type in weave Fig. 221), and 90 picks split hose (as shown by means of *cross* type in weave Fig. 221) are required for one length of wick, as shown in Fig. 220 on a reduced scale.

#### WICKS PRODUCED BY BRAIDING MACHINERY.

Fig. 222 illustrates such a wick, the same referring to a round structure of about  $\frac{1}{4}$  inch diameter, composed of ten strands of slightly twisted two-fold roving, encased in a covering of braiding; the average length of the wick in question being about 7 inches, used in miners' and similar lamps.

### LOOMS FOR NARROW WOVEN FABRICS.

Fabrics up to 6 or 8 inches wide, with fast edges or selvages on both sides, are woven on what are termed narrow ware looms.

When these looms were first made in this country the term of *tape loom* was generally applied to them and they varied as little in their construction as did narrow woven fabrics in their design, at that time. Later on there was a demand from the manufacturers of the goods made on these looms that their requirements be met, and the loom builders realizing that in many instances the suggestions made by the users of the looms were good ones began to gradually incorporate these suggestions into their output. The result of this collaboration between the loom builders and their clients was a variation in the construction of these looms almost as great as is the variation in the construction of fly shuttle looms for weaving various types of wide fabrics. For this reason, today, while the term *narrow ware loom* covers all the positive driven shuttle looms, the different kinds of narrow ware fabrics made must be woven on looms that will handle the warp to the best advantage as well as produce the most perfect fabric.

In classifying the different looms of this type the first to come under consideration are such as used for weaving fabrics composed of cotton, simple in their construction. These looms should be properly classed as tape looms and cover goods up to 2 or 3 inches in width, and of light weight. Many manufacturers differ as to the number of shuttles that will give them the largest production on tape work. Some of them feel that for goods not over  $\frac{3}{4}$  inch wide, that 100 shuttles in each of two looms handled by one operator (the looms running from 160 to 180 picks per minute) are the largest producers of these plain goods. On the other hand, other manufacturers assert that with such a large number of shuttles to watch, the operator cannot produce perfect goods and further than

this, when the loom is stopped for any reason, so many shuttles are idle that the advantage of the large number of shuttles when in operation is lost, and they prefer two looms with 48 pieces to 60 pieces in each loom. The general construction of these looms varies somewhat in the warp arrangement, as some users believe that one large beam that will hold a 2 or 3 month's supply of yarn is desirable, while others manufacture goods that do not make it possible to make such large warps economical.

For heavier goods of the tape type, such as shoe straps, non-elastic garter webbing, etc., it will be seen that while the goods are plain in their design they are heavy enough to require a sturdier loom than do the lighter tapes, so these goods which range up to 1½ inches in width are generally produced on looms with from 30 to 36 spaces. Some manufacturers like straight shuttles for this work and some prefer circular shuttles. It is well known that with the use of circular shuttles more pieces of a given width can be put in a loom than can be put in the same length of loom with straight shuttles, but the latter can in most instances be run at a higher rate of speed than can circular shuttles and will last longer, although there are many manufacturers of very heavy goods who prefer circular shuttles for all their work, as they maintain that they would rather have shorter looms with circular shuttles than longer looms with straight shuttles, making exactly the same quantity of goods so far as the width is concerned.

After the non-elastic webs of the shoe straps and garter web variety, come the heavy webbing looms which generally make goods from 3 to 6 inches in width. These looms are in a class by themselves owing to the fact that they are required to handle goods of 3 and 4 plies in thickness and to impart a great strain on the warp in order to produce goods that will meet the requirements of belt manufacturers and others who use them in place of leather.



**Elastic Webbing Looms.**

The elastic webbing industry in this country has grown so in the last few years that it is almost independent of other branches of weaving in almost all mills. That is, there are very few manufacturers of elastic webbing who make non-elastic webbing at the same time.

The elastic webbing looms are divided into three classes: the looms for weaving garter webbing, which is usually not over  $1\frac{3}{8}$  inches in width; the looms for making suspender webbing, which runs from 1 to  $2\frac{1}{2}$  inches in width; and the looms for the wider elastic webbing used in connection with supporters and bandages, etc., which sometimes run to 6 or 8 inches in width. The garter webbing looms average about 36 spaces and are made in various ways to produce the desired results in the fabric. While there are suspender looms running with 36 and even 42 pieces, we believe that the average number of spaces in suspender looms in this country today are about 28. In connection with the suspender work there are specially designed looms for weaving button-holes in the elastic as well as another loom of this type for weaving button-holes in the non-elastic goods.

While almost every part of the elastic loom has been improved one way or another in the last few years it is a singular fact that the tension for the rubber warp is imparted to it in the same manner that it has been for 40 years. Many ideas have suggested themselves to various individuals whereby the same tension on the rubber warp can be maintained at all times, but not enough has ever come of any of these to warrant their general introduction into the mills using rubber in their goods. The wider elastic looms for bandages, etc., are like the suspender looms in many respects, except they have a comparatively few number of shuttles.

**Ribbon Looms.**

The construction of the silk ribbon loom has changed greatly in the last fifteen years. Originally almost all ribbons were made on what were known as drop weight looms, that is, the warp was wound on spools which in turn were put on pins in a rack back of the loom. The warp-thread passed from these spools over spools in a frame near the ceiling which were called top castles. Rollers with weights were inserted in the loops of the warp. As the goods were woven these rollers with the weights gradually went near the top castle and the weaver would go back of the loom and pull the spools out sufficiently to permit them to unwind, to allow the rollers and weights to go near the floor. The automatic let-off such as is put on most of the looms today has been found to be much more satisfactory than this system and can be said to be in universal use. With the advent of the automatic let-off came the high speed loom.

When the automatic ribbon looms were first made there were between 800 and 900 lignes of ribbon in width in each loom. Gradually the looms were made longer until there were about 1100 lignes in each loom, then the double deck loom came into vogue. By this arrangement it was possible to weave 2 rows of ribbon instead of one and this increased the ligneage of the original loom approximately twenty-five per cent. Gradually the ribbon looms were made longer and longer until now it is not uncommon to see them between 25 and 26 feet long over all and their average capacity is between 1400 and 1500 lignes.

It has been found by many manufacturers of silk ribbon that a double deck loom, though it be shorter than a circular shuttle loom of the same ligneage, does not produce the quantity or quality of goods that can be obtained from the long circular shuttle loom.

The tendency in all looms for narrow fabrics has been to make them longer and longer until it seems that the limit must have been almost reached. In

doing this it has been found necessary for the loom manufacturer to do something more than simply add to the length of the loom. Every inch that has been added to the length of the loom has made it necessary to correspondingly strengthen the various mechanisms which make up the loom as a whole. Notable instances of this fact are shown on the Crompton & Knowles ribbon loom where in place of the ordinary wood lay beam, or batten beam, a steel angle beam which is not only smaller than the wood beam has to be for the length of the loom required, but it is absolutely exact in every dimension.

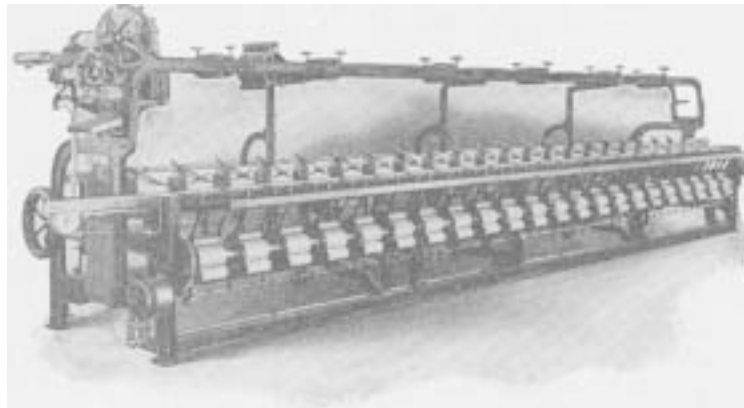
What they have done in the lay beam has also been carried into the breast beam of the loom where it will be found that in place of the ordinary wood breast beam there is an iron beam which not only strengthens the loom and prevents its getting out of shape, but also makes it much easier to attach the different fittings which go on this breast beam.

Another improvement that has been embodied in these long looms for weaving narrow fabrics are the straight connectors between the crank shaft and the lay. On many of these long looms it has been found necessary to have at least seven connectors between the crank shaft and the lay. Formerly it was customary to make the connector of two pieces of cast iron with a large off-set so that they could clear the harness frames. This meant that each of these connectors would weigh something like 25 pounds and that the loom had to carry five or seven of these around every revolution. By substituting straight drop forge connectors which weigh only five pounds each it will be seen that an improvement in the right direction was made in this respect. Fig. 223 shows the Crompton & Knowles Ribbon Loom in its perspective view.

The Crompton & Knowles Loom Works have also originated the drop shuttle looms for woven labels and

other fabrics requiring more than one color in the filling, which are built without any overhead Marionette motion. These drop shuttle looms have from two to five shuttles for each piece and by the ingenious arrangement all overhead work has been eliminated and the smashes that were so disastrous on looms of this type are overcome.

About the only thing on a narrow fabric loom giving the user any anxiety as to its efficiency are the shuttles and blocks. With the advent of the very long lays it was soon discovered that the expense of returning these long lays to the builders to be retopped was almost prohibitive, so Crompton & Knowles Loom



**Fig. 223**

Works make all their shuttles and blocks that are put on a lay or batten interchangeable so that if new ones are required they can be sent by the loom builder to the mill and attached by the loom fixer without trouble.

**Lay of the Crompton & Knowles Ribbon Loom.**

As previously referred to, ribbon looms, on account of their length (up to 26 feet long over all) require a solid wooden beam, some five inches or more in thickness and in height, for their lay.

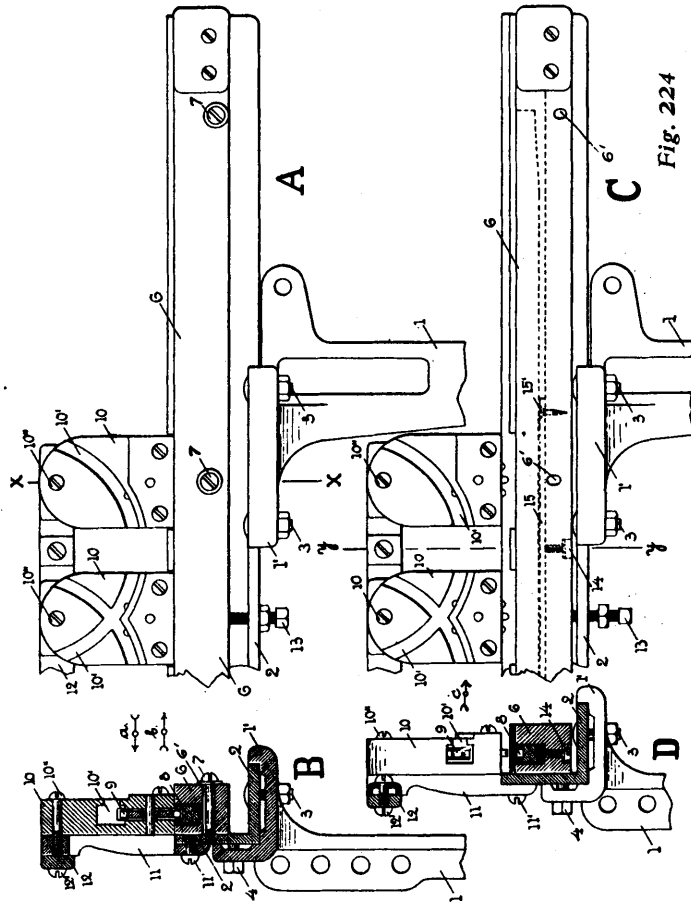
This feature is overcome in the Crompton & Knowles loom by substituting for it a metal bar (of angle shape in cross section) termed an *angle iron*, giving in turn greater rigidity to the lay and preventing its getting out of line. Combined with this angle iron bar is a wooden bar, detachably secured thereto by screws upon its front side, and which bar has a longitudinal recess therein, to receive the reciprocating rack.

To remove the rack, it is then only necessary to remove the screws which attach the wooden bar carrying the rack to the angle iron bar, and allow said bar to drop down onto the lower surface of the angle iron bar, so that it can be moved outwardly and the rack raised out of it.

To more clearly explain the construction and operation of this lay, Fig. 224 is given, and of which Diagram *A* is a front view of the right hand end of the lay and the upper part of a lay sword, etc., looking in the direction of the arrow *a* towards Diagram *B*. The latter is a section, on line *x—x* of Diagram *A*, looking in the direction of arrow *b*. Diagram *C* corresponds to Diagram *A*, but shows the bar carrying the rack dropped down to allow of the removal of the rack, also showing an adjusting screw for the rack. Diagram *D* is a vertical section on line *y—y* of Diagram *C*, looking in the direction of arrow *c* of same figure.

In the four diagrams shown, numeral of reference I indicates the upper part of the lay sword, connected and operated in the ordinary way. Two or more of these lay swords are employed, according to the width of the loom. The upper part of these lay swords have upon their upper ends, at their front sides, extensions or brackets 1', forming surfaces to receive an angle iron bar 2, of angle shape in cross section of iron or steel, which forms the lay beam of the loom. This angle iron bar 2, is rigidly secured to the bracket

1', on the upper end of the lay 1, by bolts 3, through its lower surface, and by bolts 4 at its rear side. The



angle iron bar 2 extends the full width of the loom, and forms the lay beam, taking the place of the ordinarily used wooden beam.

Extending along the front side of the vertical portion of the angle iron bar 2 is a bar 6, adjustably connected to the former by screws 7, extending through elongated openings 6', in the bar 6, and screwed into the vertical portion of the angle iron bar 2.

The upper side of the bar 6 is recessed, to receive the longitudinally moving rack 8, which is operated by the shuttle operating mechanism illustrated and explained in connection with Figs. 231 and 232.

This rack 8 engages and drives a series of pinions 9, which engage and operate the swivel shuttles (not shown) causing them to move in the guides 10' of the guide blocks 10, in the usual way. The latter are secured at their upper ends by screws 10'' to the upper end of vertically extending stands 11, which are secured at their lower ends, by screws 11', to the upper part of the vertically extending part of the angle iron bar 2. A rail 12, secured to the upper part of the stands 11, by screws 12', extends transversely across the loom and forms a hand rail.

Screws 13 are for adjusting bar 6, as carrying the rack 8, the holding screws 7 being for this work turned out, and after the bar 6 is adjusted they are turned in, so as to secure the bar in its adjusted position.

In Diagrams *C* and *D* are shown means for adjusting the vertical position of the rack 8, independently of any adjustment of the bar 6, in which it is supported, such adjustment being required to regulate the meshing of the teeth of said rack with the teeth of the pinions 9.

Said means for adjustment consists in an adjusting screw 14, turning in a threaded hole in the lower part of the bar 6 and bearing at its upper end against a yielding strip 15, which extends under the lower part of the rack 8 and is secured at each end by a screw 15' to the bar 6. By turning the screw 14, in or out, the strip 15 is raised or lowered, to thus raise or lower the rack 8 as the case may require.

When it is desired to remove the rack 8, the screws 7 are removed to allow the bar 6 to drop down (as

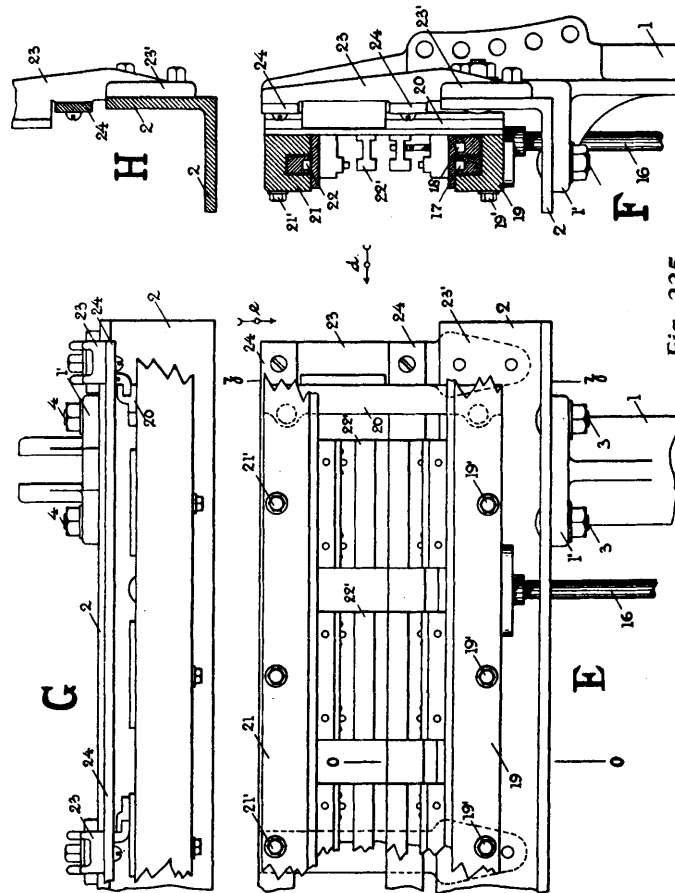


Fig. 225

shown in Diagram C) the adjusting screws 13 being also turned down. When the bar 6 is in its lowered



position, as shown in Diagram *C*, it may be readily removed from the front of the lay, to permit the removal of the rack 8.

#### LAY USED WITH DROP SWIVEL SHUTTLES.

Diagrams *E*, *F*, *G* and *H* of Fig. 225 show this lay applied to a ribbon loom having drop swivel shuttles, in this instance three banks of swivel shuttles. In said diagrams, the same numerals of reference are used to designate the same parts as were used in the four diagrams given in connection with Fig. 224.

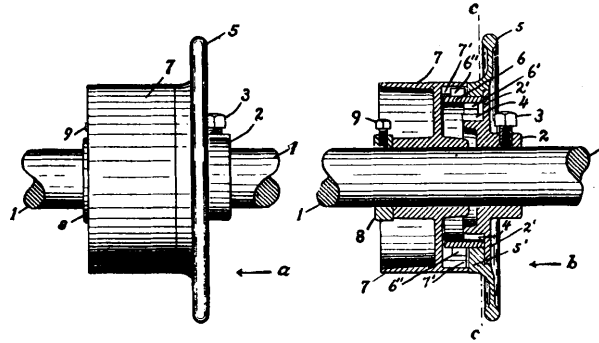
Diagram *E* corresponds to Diagram *A*; Diagram *F* is an end view and partial section on line  $z-z$  of Diagram *E*, looking in the direction of arrow *d*, same figure. Diagram *G* is a top view of the lay, shown in Diagram *E*, looking in the direction of arrow *e*, same figure. Diagram *H* is a detached view of the angle iron bar, taken on line  $o-o$  of Diagram *E*.

In addition to said parts, 16 indicates the operating rod of the shuttle rails, 17 and 18 reciprocating moving racks for the two lower banks of shuttles carried in a bar 19, which is secured by screws 19' to the lower ends of the vertically moving stands 20. The latter are adapted to have a vertical up or down motion between suitably arranged guides, through the up and down motion of the rod 16, and they have at their upper ends a bar 21, secured thereto by screws 21', which bar carries the rack 22 for the upper set of shuttles.

Intermediate the upper bar 21 carrying the rack 22, and the lower bar 19 carrying the racks 17 and 18, are arranged the guide ways or tracks 22' for the longitudinally moving swivel shuttles (not shown). The lower ends 23' of stands 23 are secured to the rear vertical part of the angle iron bar 2, which forms the lay beam. These stands 23 have secured thereto the transversely extending bars 24, which support and form the guides for the vertically moving shuttle racks, etc.

**Take-up Rollers of the Take-up Mechanism.**

In the ribbon, *i. e.*, narrow ware looms, as built by the Crompton & Knowles Loom Works, a series of take-up rollers are mounted on a common take-up shaft and revolve with said shaft to take-up or wind the fabric as it is woven. Each take-up roller can be revolved in either direction independently of the take-up shaft, in case of a shuttle thread breaking or for any other reason.



**Fig. 226**

**Fig. 227**

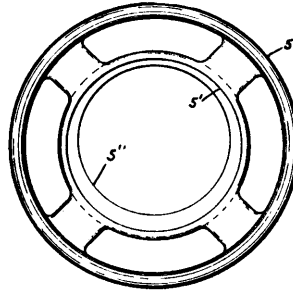
To explain the construction and working of the mechanism, illustrations Figs. 226 to and inclusive 230 are given, and of which Fig. 226 is an edge view of one of these take-up rollers, shown mounted on its take-up shaft, as extends the entire length of the loom. Fig. 227 is a central vertical section of the take-up roller shown in Fig. 226. Fig. 228 is a view of the hand wheel, detached, looking in the direction of arrow *a*, Fig. 226. Fig. 229 is a section on line *c* of Fig. 227, looking in the direction of arrow *b* same figure. Fig. 230 corresponds to Fig. 229, only that the hand wheel is removed.

A description of the mechanism is best given by quoting numerals of reference accompanying illustrations and of which 1 indicates the take-up shaft of the loom, extending the entire length of the latter.

2 is a flanged gear, secured on shaft 1 by set screw 3. This flange gear 2 has gear teeth 4 extending around its periphery, and also has the annular flange 2' extending out therefrom; on said flange 2' is mounted (to turn loosely) the hand wheel 5, which has the circular recess 5' to fit onto said annular flange 2' and the eccentric opening 5'', within which extends loosely a part of the combination gear rim 6, which has internal gear teeth 6' thereon, to mesh with the external gear teeth 4 on the flanged gear 2.

The number of the teeth 6' is greater than the number of the teeth 4. The gear rim 6 also has external teeth 6'' thereon, to mesh with the internal teeth 7' on the inner edge of the pulley 7, loosely mounted on shaft 1. The number of the teeth 6'' is less than the number of teeth 7'.

The combination gear rim 6 turns freely within the eccentric opening 5'' in the hand wheel 5, and the gear teeth 6' and 6'' on said gear rim 6 are concentric with the portion of said gear rim which extends within said opening 5''.



**Fig. 228**

The eccentricity of the opening 5'' in the hand wheel 5 is equal to the length of a tooth on the combination gear rim 6 plus any additional amount for clearance (see Fig. 229).

The inner edge of the pulley 7 bears against the inner edge of the hand wheel 5, a collar 8 secured on

the shaft 1 by a set screw 9, acting to keep the pulley 7 in position on shaft 1 and the hand wheel 5 on the flange 2' of the collar 2, and also the combination gear rim 6 in place, as is shown in Fig. 227.

THE OPERATION OF THE TAKE-UP ROLLER IS THUS: When shaft 1 revolves in the ordinary operation of the loom, the flanged gear 2, fast thereon, will revolve with it and will carry the pulley 7 and the hand wheel 5 through the combination gear rim 6 extending loosely within the eccentric opening 5" in the said hand wheel 5, as previously stated.

When it is desired to cause the pulley 7 to turn in either direction independently of the shaft 1, the latter continuing to revolve, the hand wheel 5 is turned in one direction or the other, according to whether it is necessary to turn pulley 7 forward or back.

When the hand wheel 5 is revolved in either direction (the same being loosely mounted on the flange 2' of the gear 2, fast on the shaft 1, as previously explained) the eccentric opening 5" in said hand wheel 5 (into which the concentric edge of the gear rim 6 loosely extends) causes said gear rim 6 to move, so that the internal teeth 6' thereon will be engaged continually with the teeth 4 on the gear 2 through any movement of the eccentric opening 5" in the hand wheel 5. It will thus be seen that by one revolution of the hand wheel 5 all the teeth 4 on the gear 2 will have been engaged by the teeth 6' on the gear rim 6, and if there are one or more teeth 6' than there are teeth 4, the movement of the gear rim 6 will be advanced beyond its original position by the difference in number of teeth between teeth 4 and teeth 6'.

An operation of a similar nature will take place between the teeth 7' on the pulley 7 and the teeth 6" on the gear rim 6 during the same revolution of the hand wheel 5. There being more teeth 7' than there are 6" they will be advanced forward in the same direction around the teeth 6" as the teeth 6' are ad-

vanced around the teeth 4, hence the movement of the pulley 7 independently of shaft 1 for one revolution of the hand wheel 5 and eccentric opening 5" therein will be equal to the combined advancement of the teeth 6' and 7', previously referred to. The continued revolution of the hand wheel 5 will cause the pulley 7 to revolve on shaft 1 as desired.

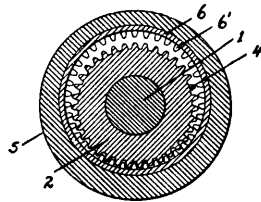


Fig. 229

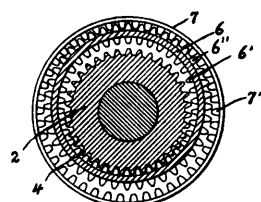


Fig. 230

When any force is applied to rotate this pulley 7 on the shaft 1 without the aid of the hand wheel 5, by reason of the multiplying power of said hand wheel as well as the eccentric opening 5" therein, pulley 7 will remain positively in any position given to it by the hand wheel 5, so that there will be no backward or forward movement.

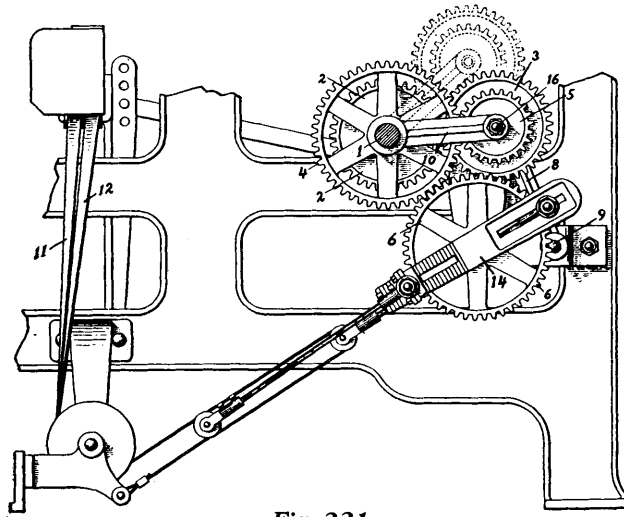
#### Shuttle-Operating Mechanism.

In narrow ware looms as built by the Crompton & Knowles Loom Works, for the weaving of ribbons, tapes, etc., a series of shuttles are used arranged in a single row and adapted to have a reciprocating movement (first in one direction and then in the other) imparted to it by a reciprocating rack and a series of pinions, also at the end of each movement of the shuttles to have a dwell, as the lay beats up.

In order to be able to better explain the construction and operation of the mechanism, Figs. 231 and 232 are given, and of which the first is an end view of the lay, and a detached portion of a loom side, showing also the shuttle operating mechanism. Fig. 232 is a detail view, showing the gearing.

The operation of the mechanism is thus: The rotation of the driven crank shaft 1 rotates gear 2 and through said gear the gears 3, 5, 4, and 6 will be rotated and the double crank mechanism connected with the gear 6 will be operated, said racks being operated in turn through connections to the shuttle racks (not shown).

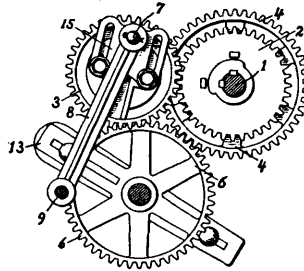
A system of spur gears is so arranged that a complete rotation of the crank shaft 1, during the forward and backward movement of the lay, will communicate a half rotation to the gears 4 and 6, so that the double crank mechanism connected with gear 6



*Fig. 231*

will be carried from one extreme position shown in Fig. 231 to its opposite extreme position, and through the connections and straps to the shuttle racks and shuttles move them to communicate to said racks and shuttles a complete movement in one direction. At the end of the latter, the continued rotation of the crank shaft 1, through gear 2 and gear 3 carrying

the crank pin 7, connected by the arm 8 to the stationary stud 9, will communicate a swinging movement to the arm 10 as loosely mounted on the crank shaft 1 and cause the gears 3 and 5 to move from the position shown by full lines in Fig. 231 to the



**Fig. 232**

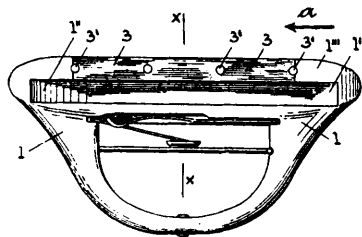
position shown by broken lines in said figure and leave the gears 4 and 6 substantially at rest and thus cause a dwell after each half rotation of the gear 6 at the end of each movement of the shuttles and shuttle racks, as the lay beats up.

With one end of the belts 11 and 12 attached to a fixed point, and the belts passing around a pulley on the crank arm connector rods, the amount of movement communicated to the shuttle operating racks is twice the movement of the crank arms 13 and 14.

By means of the plate 15, adjustable on the driven gear 3 and connected with the arm 8 pivoted on the stationary stud 9, the throw or movement of said gear 3 and the gear 5, through the movement of the arm 10 carrying the stud 16 on which the gear 3 is mounted, may be varied as desired and the amount of dwell of the gear 4 and the gear 6 driven by the gear 4 may be varied as desired, said gears being stationary during the throw or movement of the gears 3 and 5, and when consequently the amount of dwell at each end of the movement of the shuttles may be varied as desired.

**To Prolong Life of Shuttle and Shuttle-block.**

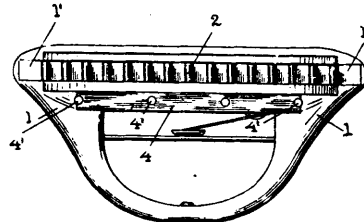
The same is accomplished in the Crompton & Knowles narrow-ware looms by providing the surface contacts of shuttle and shuttle-block with strips of



**Fig. 233**

vulcanized fibre, *i. e.*, a material harder than the body (wooden portion) of both, the purpose being to lessen the wear.

To explain the subject Figs. 233 to and inclusive Fig. 236 are given, and of which Fig. 233 is a top plan and Fig. 234 an underside view of the new shut-



**Fig. 234**

tle, Fig. 235 is a section, on line  $x-x$  Fig. 233, looking in direction of arrow  $a$  same figure. Fig. 236 is the front view of the new shuttle-block, a part of the face of the block being shown broken away to illustrate the bearing surface on the upper side of the groove or race.

Numerals of reference accompanying illustrations indicate thus: 1 the shuttle, which has its heel pro-



vided with a recess 1' on one side, for the rack teeth 2. The opposite side of the shuttle 1 is provided with an elongated groove 1'', and the rear edge is recessed and flattened as shown at 1'''. The opposite side of the shuttle, on its inner portion is also flattened, as shown at 1''' in Fig. 235.

This surface 1''' of the shuttle 1, which ordinarily forms a bearing surface of the shuttle on the shuttle block, is provided with a facing of the vulcanized

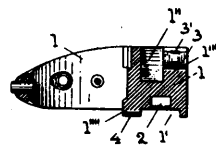


Fig. 235

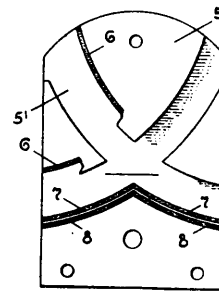


Fig. 236

fibre 3 which is attached to the shuttle by means of hard wood pins 3'. The surface 1''' of the shuttle 1 (which ordinarily forms a bearing surface of the shuttle) is provided with a facing of the vulcanized fibre 4, secured to the shuttle by means of hard wood pins 4'.

The shuttle block 5 has the undercut groove or shuttle race 5', the upper side of which is covered with a strip of vulcanized fibre 6 which engages with the bearing surface 3 on the shuttle, whereas the lower side of the race 5' is provided with two strips of the vulcanized fibre as 7 and 8 which form bearing surfaces for the facing 4 of the shuttle.

The strip 8 forms a shelf or support for the shuttle, extending outside of the face of the shuttle-block.

**Another Shuttle Driving Mechanism.**

This driving mechanism has for its object to improve the driving means in that class of narrow ware looms as are operated by a pair of straps, one end of which is connected to the sliding rack bar near one end of the lay, then passed around guide pulleys and joined to the actuating means. In this construction of narrow ware looms, the rack bar is pulled first in one direction, then pushed in the opposite direction, with the result that when pushed from one end the light rack bar is apt to buckle or spring, due to the strain required to move it against the resistance of the shuttles, especially if dealing with wide looms or a plurality of banks of shuttles. On the other hand, it is essential that the actuating means for the sliding rack bar be conveniently applied either to right or left hand battens.

To overcome these drawbacks is the object of the driving mechanism shown in Figs. 237 and 238, and of which Fig. 237 is a sectional side elevation of so much of a narrow ware loom as required to clearly disclose the driving mechanism. Fig. 238 is a cross section on the line  $x-x$ , Fig. 237.

A description of the construction and operation of the mechanism are best given by quoting numerals and letters of references used in the two illustrations and of which *A* represents a part of the loom frame to which the batten *B* is connected by swords 1, pivoted to the frame *A* at 2. Mounted upon the top portion of the batten *B* is the sliding rack bar 3, the teeth of which engage the rack teeth of the narrow ware shuttles to thereby actuate them in their passage through the sheds.

Adjustably mounted in a recess at each end of the batten *B* is a roller 4; the adjustability of these rollers 4 towards and from each other is secured by means of the axial pins 5, movable back and forth in slots 6 of the batten and held in position by means of the nuts 7 set up against the plates 8.

Disposed at the side of the loom frame are the rack bar actuating means, comprising the rolls 9 eccentrically mounted upon a shaft 10 connected to a moving part of the loom for back and forth rotary movement. Connected with each of the rolls 9 are flexible straps 11, one of which passes directly around the roll 4 at the same side of the loom and is secured to the adjacent end of the rack bar 3, the other of which passes about the guide pulley 12 secured to the batten on that side adjacent the rack bar actuating

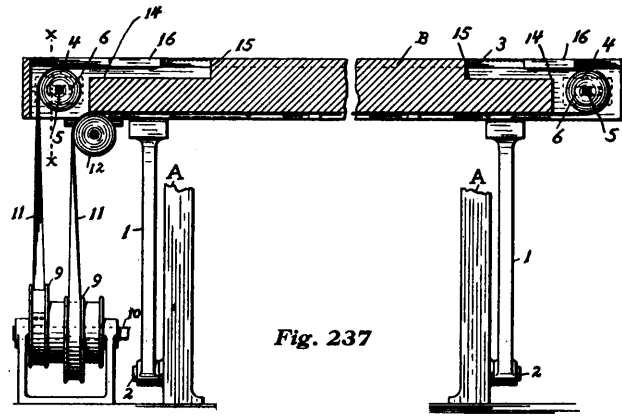


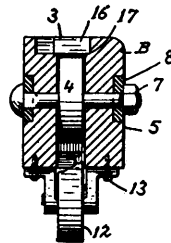
Fig. 237

means and from thence it passes lengthwise of the batten about the roller 4 at the opposite end of the loom and is secured to the adjacent end of the rack bar 3.

Since the rack bar actuating means 9 is operated first in one and then in the opposite direction it will impart to the rack bar 3, through the flexible straps 11, a pull to move the rack bar in one direction, and then a pull to move it in the opposite direction, avoiding any spring or buckling of the rack bar. This movement of the rack bar is secured from an actuating means disposed at one side of the loom, thus readily accessible for the fixer.

The guide roll 12 is secured to the batten by screws 13, so that the device can be used on either a right or left hand batten, by simply changing the guide pulley 12 to one or the other end of the batten.

Each end of the batten has an L-shaped recess 14 formed therein, the upper portion of which terminates in a stop or wall 15, the ends of the rack bar having



*Fig. 238*

side projections 16 to which the flexible connections 11 are secured. Said projections 16, and consequently the rack bar 3 are thus limited in their reciprocating movements lengthwise of the batten, the said projections riding on the ledge 17 (Fig. 238) thus effectively preventing any tipping movement of the rack bar 3 as it is reciprocated.

The latter engages the rack teeth on a number of small shuttles disposed to move in short circular or curved paths through the several sheds formed in the loom. To define the beginning and end of each reciprocation, *i. e.*, that the shuttles will be entirely clear of their sheds prior to their picking movement and be carried clear of the shed at the end of the picking movement, a simple adjustment of one or both of the rollers 4, which serve to alter or adjust the path of movement of the rack bar and consequently that of the shuttles, is all that is necessary. This mechanism can also be readily applied to looms of older construction, now installed in mills.

**Take-up for Narrow Fabric Looms.**

This take-up mechanism refers to looms equipped with drums for drawing the woven fabric from the looms, leaving in this instance the front of the loom free and unobstructed and doing away with the cumbersome wooden frame usually employed.

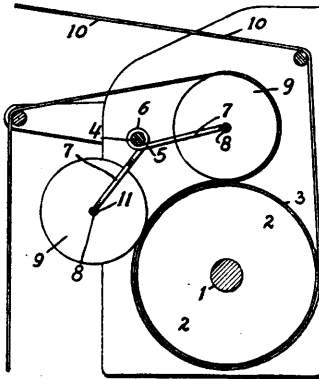
**Fig. 239**

Fig. 239 is given to show the construction and operation of this take-up. Examining the same we find rigidly mounted upon shaft 1 a series of take-up drums 2, (one for each fabric) having a surface of sand paper 3 applied thereto.

Parallel to this shaft 1 is provided a second shaft 4. Adjacent to the drum 2, shaft 4 has mounted thereupon a pair of spring wire yokes 5, provided at the centre with one or more coils 6 which constitute helical springs. The yokes are mounted upon the shaft by means of the coils 6 and have arms 7 extending in opposite directions, the latter at their ends being formed into laterally disposed toes 8. Rollers 9 are used to hold the fabric 10 in engagement with drum 2. The rollers 9 for this purpose have at their ends recesses 11 formed, to receive the toes 8 of the yokes 5 and whereby the rollers 9 are pivotally mounted in position and held in engagement with the drum 2.

The arrangement is such that the spring coils 6 force the rollers 9 against the drum 2 by means of the arms 7. Consequently, if for one or the other reason one of the rollers is forced away from the drum 2, the connecting yokes effect a firmer engagement of the other roller with the drum.

The fabric 10 passes from the fell of the cloth partly around drum 2 and between the same and the two rollers 9, and partly around the latter roller, to be delivered in turn in the proper receptacle provided.

#### **Warp-Let-Off for Narrow Fabric Looms.**

This attachment relates to ribbon or other narrow ware looms, known by the trade as German looms, in which the delivery of the warp-threads from the spool is controlled by friction and operated by the take-up of the thread.

The new let-off is most simple in its construction, uniform and positive in its action, and permits easy substitution of full for exhausted spools. It increases production about 10 per cent, produces evener and cleaner goods by less breakage of the warp-threads during weaving since the warps are always the same length, and the weights are always in the same position. This let-off will work equally as well in damp weather as in dry weather, and the weaver can let his warps back without having to go back of the loom. The device works also very successfully on wide ribbons where the ground warp is on beams, and the edges, binders, etc., on spools.

To clearly explain the construction and operation of this new let-off the accompanying two illustrations are given, and of which Fig. 240 is a vertical transverse section showing a portion of a ribbon loom with a single warp-thread spool and let-off therefor. Fig. 241 is a side elevation, partly in vertical section, on a larger scale, showing a series of spools and their let-off mechanisms. Letters of references accompanying both illustrations indicate similar parts.

*a* is the frame of a narrow ware loom, *b* is one of a group of racks supported on the frame *a*, each rack carrying a series of fixed rods *c* extending outwardly therefrom and which receive warp spools *d*. One of the spools only is shown in Fig. 240 in order to simplify said illustration; in Fig. 241 a single rack is shown, equipped with four rods and warp spools; it must be understood that the number of racks as

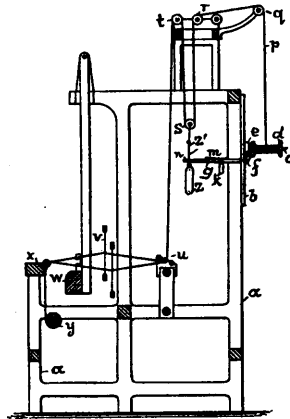


Fig. 240

well as the number of rods used in each rack can be varied, depending upon the fabric to be made.

On each rod adjacent to its point of attachment to the rack is mounted a friction-wheel *e*, free to revolve thereon except as acted upon by the short arm *f* of a friction-lever *g*, fulcrumed on pin *h*, fixed in the rack below each rod and carrying a curved shoe *i*, matching the periphery of the friction-wheel *e* which is faced with leather to insure strong frictional contact therewith. The short arm of the lever *g* carries an upwardly-projecting lug or lip *j*, adapted to lie against the outer face of the friction-wheel *e* and serves to hold the latter in position and prevent axial move-

ment. The lug *j* engages in an annular offset or shoulder formed at the junction of a raised portion or boss *l* with the main portion of the friction-wheel *e*. The latter is a hollow casting or shell having a sleeve extending from the interior face of the boss outwardly and affording a long bearing for the friction-wheel *e*.

The long arm of the lever *g* serves by its greater length and weight to hold the shoe *f* against the friction-wheel *e* and prevent its movement, the pressure being increased when required by the addition of a weight *k*, suspended from the lever *g* and adjusted to vary the frictional contact by shifting it nearer or farther from the fulcrum *h*, being held in the desired position by engaging in one of the series of notches *m* provided on lever *g* for the purpose. The extreme end *n* of the lever *g* is forked, to permit wire *z'* to pass between the two prongs formed.

The warp-spools *d* are of usual form and equipped with two outwardly-projecting broad-headed pins *o*, being ordinary round-headed wood-screws set diametrically opposite on one end face of the spool. The heads of it are received in holes in the boss *l*, sufficiently large to admit them freely, and serve by engaging with the thin shell adjacent to the openings to connect the spool with its friction-wheel, while allowing the former to be easily removed from the latter by simply disengaging the heads.

The thread *p* from the spool passes upward over a pulley *q* to a pulley *r* and thence downward around a suspended pulley *s* and again upward and over a pulley *t*, from which it passes downward under the glass bar *u* and thence through the harness *v* and lay *w*, forming the fabric, which then passes to the breast-beam *x* and in turn to the take-up roller *y*. The pulley *s*, suspended in the loop or bight of the warp between the pulleys *r* and *t*, carries a weight *z*, hung thereto by a wire *z'*, passing between the two forked



arms  $n$  of the lever  $g$ . The spool  $d$  being held against revolving and delivering, the bight supporting the weight  $z$  is gradually shortened by the weaving operation until the weight  $z$  contacts with the under surface of the lever  $g$ . A slight further rise tilts the lever sufficiently to relax the grasp of the shoe on the friction-wheel, and thus allows the spool to turn the latter and pay out the thread during the period while the weight again descends and until the shoe again

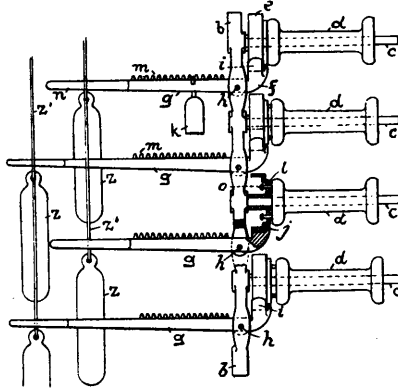


Fig. 241

grasps the friction-wheel and arrests its movement. The feed thus continues intermittently as the warp is taken up by the web until the spool is nearly empty. The latter is then removed by simply disengaging the heads of the pins  $o$  from the openings in the friction-wheel  $e$  and when a new spool is applied to rod  $c$  and engaged with the friction-wheel  $e$ . The loose end of the thread  $p$  is then tied to the free end on the new spool, the slack rewound on the latter, and the weight  $z$  allowed to descend and induce the required tension.

Each rod  $c$  with its accompanying lever  $g$  is offset from the next succeeding pair, to provide space for the several weights and levers to operate without interference, and each alternate lever is longer than the next, as shown in Fig. 241, for the same reason.

192. *Manufacture of Narrow Woven Fabrics.*

An important advantage of this let-off is the short rising-and-sinking movement of the weight *z*, thus maintaining at all times a practically uniform length of warp under tension and insuring a corresponding uniformity in the woven goods. This warp-let-off is the invention of and manufactured by William W. Uhlinger, 202 Paterson Street, Paterson, N. J.

**Equalizing Device for Silk Ribbons.**

The same relates to a device applied to narrow ware looms for equalizing silk ribbons woven thereon *i. e.*, a so-called scouring device, the equalizing effect being attained on account of the rubbing action produced on the back of the fabric while the latter is drawn over a stationary knife, fastened to the breast beam of the loom, resulting in a more closed up, *i. e.*, fuller feel to the fabric.

The five diagrams in Fig. 242 are given to explain the application and working of the device, and of which Diagram *A* is a front elevation of the device in which *b* represents longitudinally divided metal bars between the parts of which the knife *a* is adjustably held by means of the slidable collars *c*. Diagram *B* is a sectional view on the line *x-x* of Diagram *A*. Diagram *C* is a side view of that portion of a loom to which the equalizing device is applied. Diagram *D* is a plan thereof, and Diagram *E* a plan view of the knife, a series of which is used on the loom.

The device consists mainly of a knife *a* held between two semi-circular metal bars *b*, which are mounted in brackets *e*, secured to the breast beam *i* of the loom and extending rearwardly therefrom. These two bars *b* are kept together by two adjustable collars *c* held in place on the bars by set screws *d*.

The knife *a* consists of a metal plate with a cutting edge *f* on one side.

To prevent damaging the lists of the fabric, the cutting edge of the knife is, toward its ends, provided with two indentations *g*. Thus only that portion of

the knife edge extending between these two indentations is used for scouring the fabric. On drawing the ribbon *j* (see Diagram *D*) over the knife, the lists of the fabric come in place over the rounded-off cor-

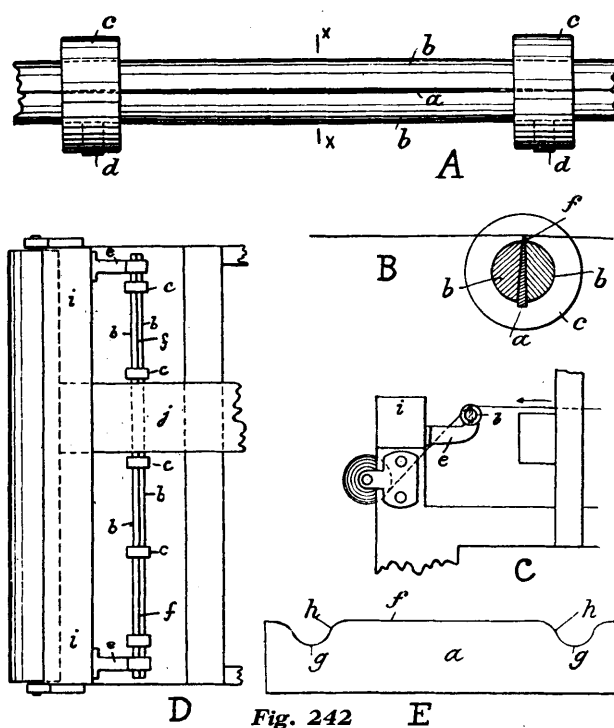


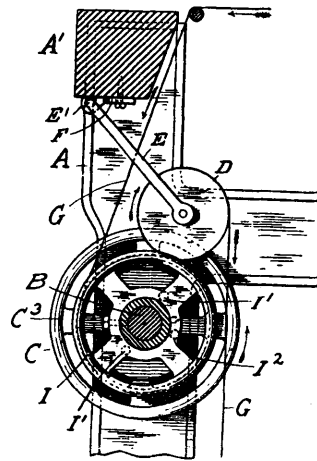
Fig. 242 E

ners *h* of the knife edge (see Diagram *E*) which arrangement prevents damaging the lists.

According to the width of the ribbons to be treated, knives of corresponding length are applied, which knives may be easily detached from the device and new ones substituted by loosening and sliding the adjustable collars (changing the knives) bringing the collars again into position over newly inserted knives.

**Individual Take-up for Narrow Fabric Looms.**

The same refers to a mechanism of the Crompton & Knowles narrow fabric loom whereby each web of the series of webs of fabrics woven simultaneously



**Fig. 243**

side by side on the loom can be independently adjusted without interfering with any of the other webs.

Fig. 243 is a side elevation of one of this series of take-up mechanisms, showing also that portion of the frame of the loom to which these take-up mechanisms refer. Fig. 244 is a transverse section through the take-up shaft with the detachable hand wheel of one of the take-up pulleys removed, showing a side view of said pulley and its spring pawl mechanism. Fig. 245 is a similar transverse section looking in the opposite direction, through the rim and hub of the take-up pulley, showing the opposite side view of said spring pawl mechanism.

Referring to our illustrations, *A* represents part of the loom frame, and *B* the take-up shaft extending longitudinally through the front side of the loom. *C* shows one of the series of individual take-up pulleys, mounted on the take-up shaft *B* about two inches apart. *D* are the knee rolls, mounted in the outer ends of the swinging arms *E*, as pivoted at *E'* to a fixed bearing *F* on cross beam *A'*. Each one of these knee rolls rests on its respective web *G* over the take-up pulleys, so as to produce the required friction on said web during weaving.

Take-up pulleys *C* are fitted loose on shaft *B* and are each held in position longitudinally thereon by an outer collar (not shown) and an internal hub *H*, both secured to shaft *B*. Upon each hub *H* are mounted at opposite sides of the shaft two pawls *a*, each being pivoted at *b* and provided with a holding spring *c*, their outer ends being adapted to engage with the longitudinally corrugated inner surface *C<sup>2</sup>* of its respective pulley *C*.

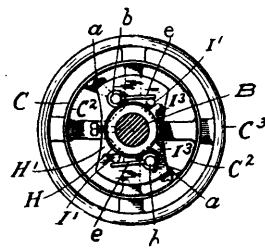
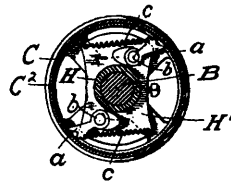


Fig. 244

The normal positions of the pawl *a* are in engagement with the thus mentioned corrugated surfaces of pulleys *C*, being held in engagement by said springs *c*, one end of which is attached to hub *H*, and the other to the pawl. The inner ends of said pawls *a* are provided with extensions to engage with the hub *H* and form a stop, so as to prevent the pawls from being drawn over too far by the spring *c*.

Combined with each take-up pulley *C* is a detachable hand wheel *I*, loosely mounted on the hub *H*. This hand wheel has thereon two projections *I'*, adapted to come in contact with two levers *e* secured upon the pivot pins *b* of the pawls *a*.



**Fig. 245**

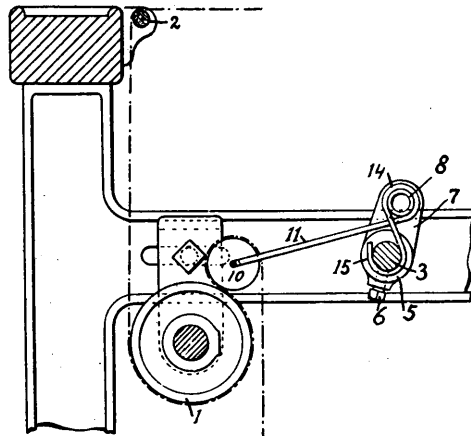
In Fig. 244 the positions of said projections on the detachable hand wheel are shown by dotted lines against the pawl pivot levers *e*.

The pawls *a*, being normally in contact with the internal corrugated surfaces of the take-up pulleys, the same are thereby normally held from turning in the direction opposite to the draft of the web *G*.

So long as no trouble occurs in the weaving, the parts remain in said locked normal positions, but if for one reason or the other it is desirable to loosen the draft upon one of the webs, its hand wheel *I* is turned to disengage the pawls *a* from said corrugated surface of the take-up pulley, by forcing its inner projection *I'* against the pawl pivot levers, as previously explained; said operation freeing said take-up pulley so that it may be turned backwards a partial revolution and thus relieve the draft upon the web so that it may be drawn longitudinally and the required repair or correction made without stopping the loom, or interfering in any way whatever with the weaving of the other webs on said loom.

**Improvement to Take-up of Narrow Fabric Looms.**

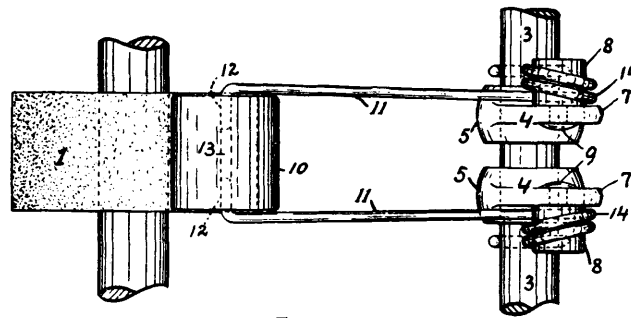
The object is to provide in combination with the sand roller of the take-up mechanism of a loom, means for maintaining the proper contact of said roller on the fabric. The device is the invention of Widmer Bros., Paterson, N. J., and can be readily attached to any make of loom.

*Fig. 246*

Of the accompanying illustrations, Figure 246 is a vertical sectional view of the device, showing also those portions of a loom to which the same more particularly refers. Fig. 247 is a plan view of the sand roller and the new attachment, shown somewhat enlarged as compared to Fig. 246.

1 refers to the sand roller, around which the fabric passes on its way downwardly from the bar 2, to the take-up roller (not shown). 3 is a fixed shaft mounted in the loom side and on which is secured a pair of brackets 4 for each sand roller, each bracket comprising a sleeve portion 5 which is slipped onto the shaft and secured against turning thereon by means of set screw 6.

An arm 7 projects upwardly from the sleeve 5 and carries a hollow stud 8, formed with a rivet 9 extending through the arm and securing the stud thereto. 10 is a pressure roller, provided to press the woven fabric (see dot and dash line) against the sand roller 1. This pressure roller 10 is carried by a spring-support comprising two elastic wires 11, each wire consisting of a substantially straight portion having one end turned off at right angles, as at 12, and introduced into the bore 13 of the roller 10. The other end of each wire is bent first upwardly to form the loop 14, and then downwardly into the form of



*Fig. 247*

the hook 15. The studs of the pair of brackets 4 project outwardly and receive on them the loops of the wires, the hooks of the latter being engaged around the shaft 3.

By changing the position of the pair of brackets 4 on its shaft 3 (after again tightening set screw 6) either more or less pressure will be exerted on the roller 10, as operating against sand roller 1, and thus onto the cloth in its travel between both rollers.



## Electric Power Increases Profits from High-Speed Ribbon Looms

A G-E motor will operate your high-speed ribbon loom faster and steadier than can be obtained from any of the lineshaft drives.

The increased value of product means a substantial addition to your profit from the loom for each and every day it is run.

Users find many other advantages attendant on the use of G-E individual-motor drive. Among them are a saving in power consumption, a freedom in arranging machinery and in supplying outlying buildings with power, cleanliness, a clear headroom and increased ease of ventilation, economy in the placing of looms, great reliability, a possible lighter and cheaper building construction, a reduced accident risk and hence cheaper liability insurance, an overtime power cost proportional to work done and a freedom for growth.

Our engineers will always be pleased to show you how to obtain the increased profits from your looms.

## General Electric Company

General Office : Schenectady, N.Y.



District Offices in :



Boston, Mass. New York, N. Y. Philadelphia, Pa. Atlanta, Ga.  
Cincinnati, Ohio Chicago, Ill. Denver, Colo. San Francisco, Cal.  
St. Louis, Mo.

Sales Offices in all Large Cities

6135

# Charles BOND Company

MANUFACTURERS OF

## OAK TANNED LEATHER BELTING

---

APRONS AND ROLL COVERS

---

IMPORTERS OF LEATHERS  
FOR TEXTILE INDUSTRIES

---

GENERAL MILL FURNISHERS

520 Arch St. :: Philadelphia, Pa.

---

## Improved Finishing Machinery

For Silk, Cotton and Woolen Goods

Calenders (hydraulic and lever pressure), Palmer Finishing Machines, Gas Singers, Padders, Drying Machines, Dyeing Machines (jiggers and compartments), Color Kettles, Color Strainers, Tentering Machines (automatic and spring clamps), Ageing Machines.

**Rolls for Calenders**

(Paper, Cotton, Combination Cotton and Husk)

## H. W. Butterworth & Sons Co.

York and Cedar Streets, Philadelphia, Pa.

TELEPHONE GRAMERCY { 4323  
4324

# HOFMANN & ELLRODT, Inc.

16-18 W. 22d St., New York

## *We Buy Job Lots*

ANYTHING CONSISTING OF RAW, THROWN AND DYED SILKS, WHETHER ORGAN, TRAM, SCHAPPE, OR SPUN SILK IN SKEINS OR ON SPOOLS, ALSO WARPS AND WARP ENDS.

COTTON, SCHAPPE, SPUN SILK, WOOL, COLORED AND RAW SILK WASTE.

ALSO COTTON AND WOOL YARNS OF ALL DESCRIPTIONS.



Telephone 3200 Union  
" 3201 "

*"Hasco"*

*Weehawken, N. J.,*

*P. O. Box B.*

**Mill 1:**

*Skein Dyeing  
Skein Printing*

**Mill 2:**

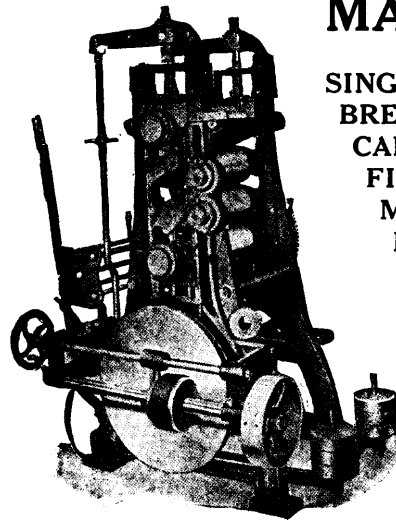
*Winding & Warping  
Winding & Copping*

# INSINGER NARROW FABRIC LOOMS

**Simplicity      Durability**  
**Efficiency**  
*are built in them*

4600 Stenton Avenue      Philadelphia

---



## MACHINERY

FOR  
SINGEING  
BREAKING  
CALENDERING  
FINISHING  
MOIRÉING, &c.  
RIBBONS AND  
BROAD GOODS  
SINCE 1881

**John J.  
Cavagnaro**  
Engineer & Machinist  
HARRISON, N. J.

**ALFRED SUTER** <sup>TEXTILE</sup>ENGINEER  
200 FIFTH AVENUE - NEW YORK

IMPORTER OF

**YARN & CLOTH  
TESTING APPARATUS and  
SCHAPPE YARNS**

---

**LAVIGNE & SUTER**  
**FRENCH TWISTED WIRE HEDDLES**  
**REED MAKING MACHINES**  
**COTTON HEDDLES                      FALSE REED WIRES**  
WRITE FOR SAMPLES AND PRICES

---

Alex. D. Stelle, President

Walter H. Rossmässler, Treasurer

**Sauquoit Silk Mfg. Company**

Manufacturers of **Organzine, Tram,  
Twist, Fringe and Hosiery Silks**

Fast Dye Organzines for Woolen Manufacturers a Specialty

**Mills:** Bethlehem, Pa.  
Philadelphia, Pa.  
Scranton, Pa.

New York Representatives: WILLIAM RYLE & CO., 225 FOURTH AVENUE

PHILA. OFFICE : 4015 Clarissa St. (18th St. & Hunting Park Ave., Nicetown)

CHICAGO OFFICE : 206 So. Market St.

Boston Agents: STELLE & SHERMAN, 52 Chauncy St.

. . . . Silks for Insulating Purposes . . . .

## SHAMBOW SHUTTLES

1. Weave fewer seconds
2. Preserve bobbins
3. Wear longest

"Weave better fabric at less expense"



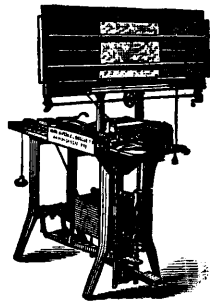
SEND  
FOR SAMPLE  
AND PRICES  
OF OUR  
LATEST DESIGN  
"EFFICIENCY" SHUTTLE

—WRITE—

**Shambow Shuttle Co.**  
Woonsocket - R. I.

---

## F. G. LENTZ & CO.

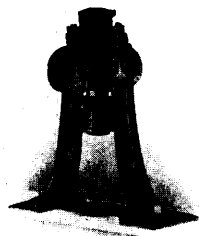


**Designers,  
Card Stampers  
and Harness  
Builders**

FOR ALL TEXTILE FABRICS

**Mascher, Waterloo and York Streets**  
Both Phones **PHILADELPHIA, PA.**

# “SELLERS”



## SHAFTING

EQUIPMENT  
FOR

## TEXTILE MILLS

WRITE FOR CATALOG “A”

**WM. SELLERS & CO.,** Incorporated  
PHILADELPHIA, PA.

New England Office: BOSTON, MASS.

### **Fiberlic**

## JACQUARD CARDS

The best in the market

### **Strong, Tough and Moisture Proof**

Will Register most accurately with Cylinder and Needles under any climatic condition of room, and speed of loom; preserving the life of card as well as preventing imperfections of fabric in weaving.

Will outlast all others

Used by leading Mills and highly recommended

**MACANDREWS & FORBES COMPANY**

CAMDEN, N. J.

# Technology of Textile Design

A Practical Treatise on the Construction and Application of Weaves  
for all Kinds of Textile Fabrics, Giving Also Full  
Particulars as to the Analysis of Cloth

By **E. A. POSSELT**

Editor of *Posselt's Textile Journal*

*In One Vol., Quarto. Bound in Cloth, 350 Pages, With  
Over 1500 Illustrations. Price Five Dollars,  
Postage Prepaid, Delivery Guaranteed.*

## ABSTRACT OF CONTENTS:

DIVISION OF TEXTILE FABRICS ACCORDING TO THEIR CONSTRUCTION. SQUARED DESIGNING PAPER.

**FOUNDATION WEAVES:** PLAIN. TWILLS. SATINS.

DRAWING-IN DRAFTS.

**DERIVATIVE WEAVES:** RIB WEAVES. BASKET WEAVES. BROKEN TWILLS. STEEP TWILLS. RECLINING TWILLS. CURVED TWILLS. COMBINATION TWILLS. CORKSCREWS. ENTWINING TWILLS. DOUBLE TWILLS. CHECKERBOARD TWILLS. FANCY TWILLS. POINTED TWILLS. DOUBLE SATINS. GRANITES. COMBINATION WEAVES. COLOR EFFECTS.

**SPECIAL SINGLE CLOTH WEAVES:** HONEYCOMB WEAVES. IMITATION GAUZE WEAVES. ONE SYSTEM WARP AND TWO SYSTEMS FILLING. SWIVEL WEAVING. TWO SYSTEMS WARP AND ONE SYSTEM FILLING. LAPPET WEAVING. TRICOTS.

**DOUBLE AND MORE PLY CLOTH:** REGULAR DOUBLE CLOTH. WORSTED COATINGS. MATELASSES. QUILTS. RIB FABRICS. THREE, FOUR, ETC., PLY FABRICS.

**PILE FABRICS:** VELVETEENS. FUSTIANS. CORDUROYS. CHINCHILLAS. CHENILLE. FRINGES. VELVETS. PLUSHES. TAPESTRY CARPETS. BRUSSEL'S CARPETS. DOUBLE FACED CARPETS. DOUBLE PILE FABRICS. TERRY PILE FABRICS. SMYRNA CARPETS AND RUGS. IMITATION TURKEY CARPETS.

**TWO PLY INGRAIN CARPETS. GAUZE FABRICS. THE JACQUARD MACHINE. GOBELIN TAPESTRY. ANALYSIS OF TEXTILE FABRICS.**

**NOVELTIES IN DESIGNING:** DESIGNING WEAVES BY FOUR CHANGES. SHADED FABRICS. SOLEIL WEAVES. CHECK PATTERNS. CRAPE WEAVES. HUCK PATTERNS. WOVEN TUCKS. CRIMP STRIPES. BEDFORD CORDS. CROCODILE CLOTH. LARGE DIAGONALS. TO INCREASE THE THICKNESS OF A FABRIC WITHOUT SPECIAL BACKING THREADS. BRACKET WEAVES. FRINGES. PEARL EDGES.

**THIS IS THE MOST IMPORTANT BOOK ON  
TEXTILE DESIGNING EVER PUBLISHED**

*Complete Circulars mailed upon application.*

**Textile Publishing Company**  
2154 North 21st Street Philadelphia, Pa.



Specimen Page of "Technology of Textile Design."  
(Reduced in Size)

261

The cuts in the fabric are shown at the places indicated by *e* and *f*. Letter *S* indicates the place where the first warp-thread and the first pick meet—the point for commencing to "pick-out."  
After the sample is prepared according to the illustration just given, raise the first pick about  $\frac{1}{4}$  of an inch with the "picking-out needle." See Fig. 1010.

Place the sample in the left hand as shown in diagram 1011, next ascertain the arrangement of interlacing pick number 1, warp-ways, until repeat is obtained.

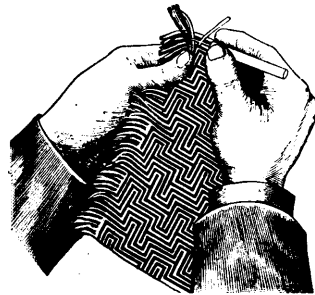


FIG. 1011

Every time a warp-thread is found situated above the filling, put a corresponding indication on the respective square of the designing paper (with pencil marks or prick holes with the needle), whenever you find the filling covering (floating over) one, two or more successive warp-threads, leave correspondingly one, two or more successive squares empty in the lateral line of small squares upon the designing paper.

After the intersecting of number 1 pick has been clearly ascertained liberate this pick out of the fringed warp edge and duplicate the procedure with pick number 2, to be followed by picks 3, 4, 5, etc., until the repeat is obtained. If dealing with a soft-spun filling yarn be careful in raising it, to avoid breaking the thread; also be careful that after the interlacing of the pick has been ascertained, it

is entirely removed so that no small pieces of the thread remain in the fringed part of the warp; for if such should be the case it might lead to mistakes in examining the next adjoining pick.

### III. Ascertaining Raw Materials Used in the Construction of a Fabric.

In most cases an examination of the threads liberated during "picking-out" with the naked eye will be sufficient to distinguish the material used in the construction of the fabric yet sometimes it is found necessary to use the microscope or a chemical test for their detection. For example: Tests might be required to show whether a certain thread is all wool or whether a certain thread is all silk, etc. For solving such questions, the following methods are given:

A common and ready method for ascertaining the difference between animal and vegetable fibres is to burn some of the threads of yarn in a flame. The vegetable fibre is composed of carbon, hydrogen and oxygen, while the animal fibre, in addition to these, contains nitrogen. By burning, the threads used in testing the first mentioned fibre will result in carbonic acid and water, while those of the latter, or of animal fibre, result in combinations containing nitrogen which element readily makes itself known by its peculiar smell or disagreeable odor similar to burnt feathers. Another point which it is well to note is the rapidity with which the thread composed of vegetable origin burns as compared with the burning of the thread having an animal substance for its basis. In the latter case, only a little bunch of porous carbon forms itself at the end submitted to the flame, and it does not form a flame as in the case of the former. As in some instances these two tests will be found unreliable, a more exact analysis may be required. If so, proceed after one or the other of the following formulas:

#### To Detect Cotton or other Vegetable Fibre in Woolen or Silk Fabrics.

Boil the sample to be tested in a concentrated solution of caustic soda or potash, and the wool or silk fibre will rapidly dissolve, producing a soapy liquid. The cotton or other vegetable

# Textile Calculations

A Complete Guide to Calculations Relating to the Construction of all Kinds of Yarns and Fabrics, the Analysis of Cloth, Speed, Power and Belt Calculations.

BY

**E. A. POSSELT**

Editor of *Posselt's Textile Journal*

**In One Vol., Quarto. Bound in Cloth, 186 Pages,  
Numerous Illustrations. Price Two Dollars, Post-  
age Prepaid, Delivery Guaranteed.**

## ABSTRACT OF THE CONTENTS

### YARN AND CLOTH CALCULATIONS

Grading of the Various Yarns Used in the Manufacture of Textile Fabrics According to Size or Counts. To Find the Equivalent Counts of a Given Thread in Another System. To Ascertain the Counts of Twisted Threads Composed of Different Materials. To Ascertain the Counts for a Minor Thread to Produce, with Other Given Minor Threads, Two, Three or More Ply Yarn of a Given Count. To Ascertain the Amount of Material Required for Each Minor Thread in Laying out Lots for Two, Three or More Ply Yarn. To Ascertain the Cost of Two, Three or More Ply Yarn. To Find the Mean or Average Value of Yarns of Mixed Stocks. Reed Calculations. Warp Calculations. Filling Calculations. To Ascertain the Amount and Cost of the Materials Used in the Construction of All Kinds of Plain and Fancy Cotton and Woolen Fabrics.

### STRUCTURE OF TEXTILE FABRICS

The Purpose of Weave that the Fabric will be Subject to. The Nature of Raw Materials. Counts of Yarn Required to Produce a Perfect Structure of Cloth. To Find the Diameter of a Thread by Means of a Given Diameter of Another Count of Yarn. To Find the Counts of Yarn Required for a Given Warp Texture by Means of a Known Warp Texture with the Respective Counts of the Yarn Given. Influence of the Twist of Yarns upon the Texture of a Cloth. To Find the Amount of Twist Required for a Yarn if the Counts and Twists of a Yarn of the Same System, but of Different Counts, are Known. Influence of the Weave upon the Texture of a Fabric. To find the Texture of a Cloth. To Change the Texture for Given Counts of Yarn from one Weave to Another. To Change the Weight of a Fabric without Influencing its General Appearance. To Find Number of Ends Per Inch in Required Cloth. Weaves Which will Work with the Same Texture as the two and two Twill. Weaves which will Work with the Same Texture as the three and three, four and four, etc., Twill. Selections of the Proper Texture for Fabrics Interlaced with Satin Weaves. Rib Weaves. Corkscrew Weaves. Two Systems Filling and One System Warp. Two Systems Warp and One System Filling. Two Systems Warp and Two Systems Filling.

### ANALYSIS

How to Ascertain the Raw Materials Used in the Construction of Textile Fabrics. Microscopical Appearance of Fibres. Tests for Ascertaining the Raw Materials Used in the Construction of Yarns or Fabrics. How to Ascertain the Percentage of Each Material Constituting the Fabric. How to Test the Soundness of Fibres or Yarns. How to Test Given Counts of Yarn. How to Ascertain the Weight of Cloth. How to Calculate the Weight. How to test and Analyze the Various Finishes. Cotton Spinning.

### SPEED, BELTING, POWER, Etc.:

Speed. Belting. Water Power. Steam Power. Heat.  
Arithmetic. U. S. Measures. Metric System.

*Complete Circulars mailed upon application.*

**Textile Publishing Company**  
2154 North 21st Street Philadelphia, Pa.

**Specimen Page of "Textile Calculations."**  
(Reduced in Size)

79

*Example.*—Find the proper texture for warp and filling, and also ascertain the weight of flannel per yard from loom (exclusive of selvage). Cloaking: Warp 5-run, filling 5-run, backing 2½-run. Weave, see Fig. 40 (8 warp threads and 13 picks in repeat). Take-up of warp, 10 per cent. Width of cloth in reed, 72 inches (exclusive of selvage).



FIG. 40

5-run=8,000 yards per lb.  
 $\sqrt{8,000}$ , less 16 per cent.=75 ends of 5-run yarn will lie side by side in one inch.  
 $75 \times 4 = 300 + 6 = 50$  ends of warp must be used per inch, and  
 $50 \times 72 = 3,600$  ends must be used in full warp.  
 $100:90::x:3,600$   
 $3,600 \times 100 = 360,000 + 90 = 4,000$  yards of warp yarn are required per yard cloth woven.  
 5-run yarn=500 yards per oz.  $4,000 \div 500 = 8$  oz. of warp yarn are wanted.  
 52 picks (50+2 extra) of face filling, } are wanted per inch  
 26 picks (corresponding to face picks) of back filling, }  
 $52 \times 72 = 3,744$  yards of face filling are wanted.  
 $3,744 \div 500 = 7.5$  oz., weight of face filling.  
 $26 \times 72 = 1,872$  yards of backing are required.  
 $1,872 \div 250$  (yards of 2½-run filling per oz.)=7.5 oz., weight of backing.

Warp,	8.00 oz.
Face filling,	7.50 "
Backing,	7.50 "
	23.00 oz.

*Answer.*—Total weight of cloth per yard from loom (exclusive of selvage), 23 oz.

**SELECTION OF THE PROPER TEXTURE FOR FABRICS BACKED WITH WARP; i. e., CONSTRUCTED WITH TWO SYSTEMS OF WARP AND ONE SYSTEM OF FILLING.**

To ascertain the texture of the warp in these fabrics we must first consider the counts of the yarn as used for the face structure, and secondly the weave.

After ascertaining this texture (for the single cloth) we must consider the weave for the back warp; i. e., the stitching of the same to the face cloth. If dealing with a weave of short repeat for the back warp (for example a 1—3 twill) we must allow a correspondingly heavy deduction from the threads as ascertained for the face cloth (about 20 per cent. for the 1—3 twill); whereas, if dealing with a far-floating weave for the back (for example the 8-leaf satin) we will have to deduct less (about 10 per cent. for the 8-leaf satin) from the previously ascertained texture of the face cloth. Since the 8-leaf satin is about the most far-floating weave, as used for the backing, thus, 10 per cent. will be about the lowest deduction, and as the 1—3 twill is the most frequently interlacing weave, in use in the manufacture of these fabrics, thus, 20 per cent. deduction from the respectively found texture of the face cloth is the maximum deduction. To illustrate the subject more clearly to the student we will give both weaves as previously referred to with a practical example.

*Example.*—Find warp texture for the following fabric: Fancy worsted trousering.  
 Weave, see Fig. 41. Face warp, 2/36's worsted. Back warp, single 20's worsted.  
 2/36's worsted = 90 threads (side by side per inch).



FIG. 41.

Face weave 2—3 twill = 4 threads in repeat and 2 points of interlacing.  
 $90 \times 4 = 360 + 6 = 60$  threads, proper warp texture for the single structure.  
 60  
 —12 (20 per cent. deduction caused by the back warp (1—3) stitching in the face structure).

**HAND BOOKS OF THE TEXTILE INDUSTRY, VOL. I.**

---

# **Dictionary of Weaves**

**PART I.**

**A COLLECTION OF ALL WEAVES FROM  
FOUR TO NINE HARNESS**

**By E. A. POSSELT**

*Editor of Posselt's Textile Journal*

**Two Thousand Weaves Conveniently Arranged  
for Handy Use**

---

## **Lexicon der Gewebemuster**

**Band I.**

*Eine Sammlung von allen Gewebemustern von vier bis neun-  
schäftig. Zwei Tausend Gewebemuster für den  
praktischen Gebrauch geordnet.*

---

## **Manuel des Dessins du Tissage**

**Première Partie**

*Une collection de Tous Genres des Dessins du Tissage  
de Quatre à Neuf Lisses.  
Deux Mille Dessins Classés à Convenance.*

---

**TEXTILE PUBLISHING COMPANY**

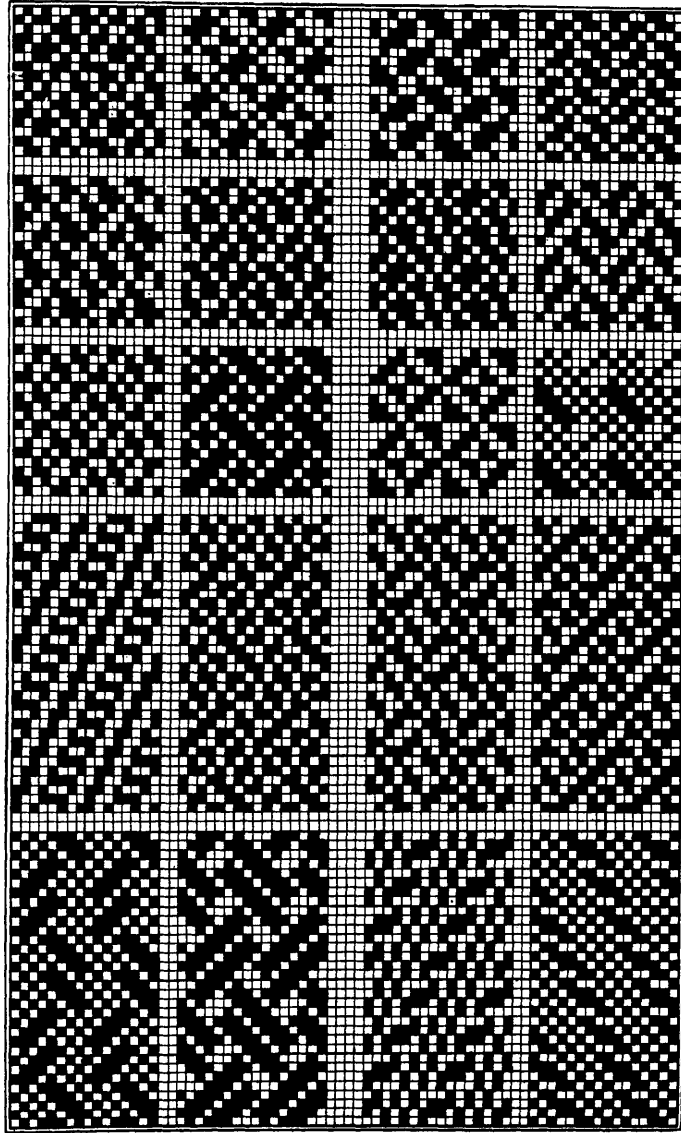
2154 North 21st Street, Philadelphia

London, Eng.: Sampson Low, Marston & Co., Ltd.

**Bound in Cloth and Gold, Price Two Dollars**

Specimen Page of "Dictionary of Weaves, Part 1."

EIGHT HARNESS



8 × 8

8 × 16

# Wool, Cotton, Silk

## From Fibre to Finished Fabric

By E. A. POSSELT  
Editor of Posselt's Textile Journal

*In One Vol., Quarto. Bound in Cloth, 473 pages,  
Thousands of Illustrations. Price Five Dollars,  
Postage prepaid, Delivery guaranteed.*

**T**HIS book contains detail information as to the various machines and processes used in the manufacture of either Wool, Cotton or Silk, from the Raw Material to the Finished Fabric, including Weaving and Knitting.

The various chapters cover information as to the

**Raw Materials: Wool, Cotton, Silk,  
Flax, Hemp, Jute and Ramie.**

**Preparatory Processes: Carding, Drawing,  
Spinning and Twisting.**

**Winding, Warping and Weaving.**

**Knitting.**

**Dyeing, Bleaching, Mercerizing.**

**Finishing Woolen and Worsted Cloth.**

**Heat, Power, Speeds and  
Transmission.**

---

*The information contained in the chapters on Fibres, the various Finishing Processes and its Machinery used is a most complete treatise on the subject and will be found of incalculable value by any Manufacturer or Finisher of Cotton, Woolen or Worsted Fabrics.*

*Complete Circulars mailed upon application.*

**Textile Publishing Company**  
2154 North 21st Street Philadelphia, Pa.

Specimen Page of "Wool, Cotton, Silk from Fibre to Finished Fabric."  
(Reduced in Size)

large, white, coarse, long wool, and the breed has become practically native to this country. The structure of the fibres is shown in Fig. 10. In the Cotswold, we find the lines indicating the edges of

fibres are examined in the natural state with the microscope, we find extending through the centre a band of matter more or less broad, which is very much more opaque than the matter surrounding it.

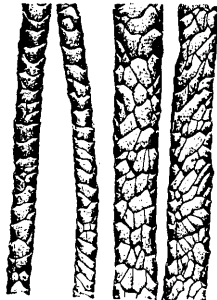


Fig. 9.

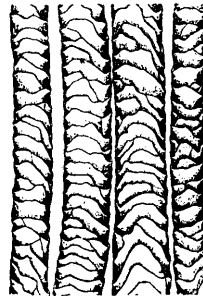


Fig. 11.

the scales more irregular and broken than in the Leicester and Lincoln; and more so in the Lincoln than in the Leicester. In all of them the scales are more or less oblong, but in width they are much larger than in the Downs and Merinos.

If we compare locks of Cotswold and Lincoln wool

The forms of this band are given in the illustration of Cotswold wools. It appears to be of irregular thickness and to allow more light to pass through at certain places than at others.

The Oxford Down Sheep is also of English origin, being a cross between the Cotswold ram and the Hampshire Down ewe. The wool produced by the Oxford Down is finer and firmer than that of the Cotswold and has a staple of from 5 to 7 inches in length, the average weight of the fleece being 9 pounds. Fig. 11 shows typical specimens of these fibres highly magnified. The wool of this sheep, as well as that from the Cotswold, the Leicester and the Lincoln are the most important classes of what we term long staple wools, vice versa the Merino and the Southdown sheep, which are the most important

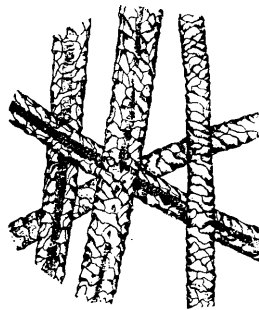


Fig. 10.

we find that a larger proportion of the fibres in the former are more white and opaque than the others, and that the whole bunch has very much less of lustre than the Lincoln wool. When these Cotswold

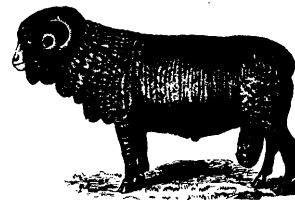


Fig. 12.

breeds of sheep, producing what we term short staple, carding or clothing wools.

The Merino Sheep. The original home of this animal is Spain, from there they have been spread

# Textile Machinery Relating to Weaving

By E. A. POSSELT

Editor of *Posselt's Textile Journal*.

A treatise giving Descriptive Illustrations of the Construction and Operation of Various Looms, Jacquards, Warpers, Beamers, Slashers, Spoolers; also Illustrating and Explaining Different makes of Shuttles, Temples, Pickers, Reeds, Heddles, Harnesses, etc.,

FOR THE USE OF

Manufacturers, Mill Managers, Designers, Boss Weavers, Loom Fixers, Students and Inventors.

Published in Two Parts, each treating Different Machinery, Classified in Separate Chapters as follows:

<b>Shedding Mechanisms.</b>	<b>Shuttles.</b>
<b>Box Motions and Shuttle Boxes.</b>	<b>Temples.</b>
<b>Let-off Mechanisms.</b>	<b>Reeds and Reed Motions.</b>
<b>Take-up Mechanisms.</b>	<b>Heddles and Harnesses.</b>
<b>Warp Beams.</b>	<b>Jacquards and Card Stampers.</b>
<b>Stop Motions.</b>	<b>Spoolers, Winders and Reels.</b>
<b>Picking Mechanisms.</b>	<b>Warpers and Beamers.</b>
<b>Miscellaneous Machinery.</b>	

Both Parts, with Over 1200 Illustrations, describe nearly 500 items of different Machinery, Devices and Supplies, Relating Directly to the Weave Room.

Each Volume Bound in Cloth, Price \$1.50, Postage prepaid. Delivery guaranteed.

Price of Both Volumes if ordered at one time \$2.50, Postage prepaid, Delivery guaranteed.

*Complete Circulars of both books mailed upon application.*

**Textile Publishing Company**  
2154 North 21st Street Philadelphia, Pa.



Specimen Page of "Textile Machinery Relating to Weaving."  
(Reduced in Size)

gear, which meshes with the bottom double spur gear, thus in turn reverses the chain cylinder gear and its cylinder.  
Spring  $\theta$  connects to the lock knife  $\sigma$ . (See Fig. 3.) This lock knife is operated by means of finger  $\sigma'$ , fastened to rod  $\sigma''$  by a set screw, and which finger in turn is operated by a cam (not shown) fastened on the bottom cylinder  $e$ .

Three upright arms (one on each end and one in centre of the head motion) extending upward on shaft  $\sigma''$  hold lock knife  $\sigma$  by means of set screws.  
As the chain ball (riser) of pattern chain  $p$ , comes under the heel of the vibrator lever  $f$ , the cam which

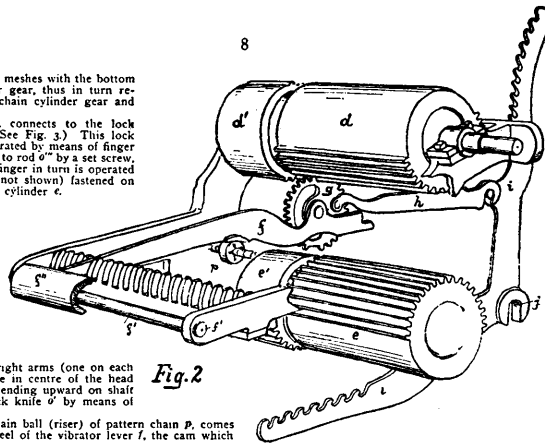


Fig. 2

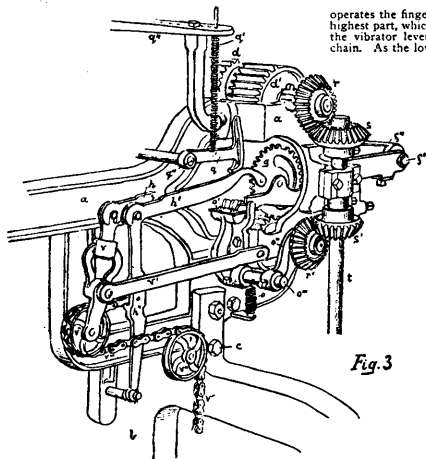


Fig. 3

operates the finger  $\sigma'$  of the lock knife must be on its highest part, which causes the knife to be out, allowing the vibrator lever  $f$  to change according to pattern chain. As the low part of the cam comes around, the spring  $\theta$  will immediately pull the lock knife in between the ends of the vibrator lever  $f$ , holding them steady while vibrator gears  $g$ , are rotating.  
 $p$  is the chain rack for holding the chain in position and away from the jacks.  
Vibrator levers  $f$ , are fulcrumed on rod  $p$ , and held in position by shell  $r$ .  
Every vibrator connector  $h$ , has connected to it a follower-lever  $d$ , the object of which is to keep connector  $h$  from flying back when the harness rises. Every follower-lever is pressed down by means of a spring  $\theta$ , held in position by rack  $q$  and turns on shaft  $q'$ . Cylinders  $d$  and  $e$ , are driven by bevel gears  $s$  and  $s'$ , which in turn are driven by bevel gears  $s$  and  $s'$  keyed to upright shaft  $4$ , driven either from crank shaft or bottom shaft of the loom as required.  
 $s$ , is a hand wheel used by the operator for turning harnesses by hand when necessary.  
 $k$ , is the lever for a single box lift (box No. 2);  $v$ , compound lever for raising box 3 and 4;  $u$ , brace for holding compound lever in position;  $w$ , the pulleys around which box chain  $v'$ , runs for raising the boxes.

# Cotton Manufacturing

---

A Complete Treatise on Modern Processes and Machinery Used in Connection with Cotton Spinning, Including all Calculations Required. Published in Two Parts.

By

**E. A. POSSELT**

Editor of *Posselt's Textile Journal*

**Volume 1** Gives on 200 pages a Complete Description of the Manufacture of Cotton Yarns from Planting the Seed to the Sliver, ready for the Drawing or Combing; Covering: Fibre, Ginning, Mixing, Picking, Scutching and Carding.

**Volume 2** Takes up the subject where Volume 1 leaves off, 300 pages, covering: Combing, Drawing, Roller Covering and Fly Frames, *i. e.*, the transforming of the Sliver into Roving for the Ring Frame or the Mule.

Each Volume, Richly Illustrated, Bound in Cloth, Price Three Dollars, Postage prepaid, Delivery guaranteed.

Price of Both Volumes, if ordered at one time Five Dollars, Postage prepaid, Delivery guaranteed.

Complete circulars of Both Books mailed upon application.

---

**Textile Publishing Company**

2154 N. 21st Street

Philadelphia, Pa.

with the flats, we find that the bristles are mounted in two double series (extending diagonally across the width of the roller) in lags *A* and extend through brass plates *B*. The length which these bristles extend outside of plate *B* is regulated by a screw *C*, thus permitting ready adjustment of the bristles when worn, in order that they penetrate the teeth of the flats to the proper extent. It will be readily understood that the bristles of the brush penetrate the clothing of the flats deeper than do the wire teeth *D* which do the actual stripping, whereas the bristles will effect a thorough cleaning of the foundation of the clothing of the flats. Above the brush is mounted a tooth clearer *E* which in its normal position has its wire teeth *G* held only slightly in contact with the wire teeth *D* of the brush by means of a spring *F*, the action of its wire teeth on the wire points of the stripping brush being only to press the strippings into the latter and thus prevent their falling into the flats again. When it is necessary to clean the brush, the clearer *E* is moved from its position above the brush down to the lower position *E'* shown in the illustration and then pressed inward so that its wire teeth *G'* will penetrate into the wire portion of the brush, and when in turn the clearer is bodily moved up to its former position *E* while the brush is rotated in the opposite direction, this procedure effectually cleaning the wire clothing of the brush. The brush when in operation is driven at a slow speed, from 5 to 10 revolutions per minute, and on account of this as well as the few bristles used in its construction and their manner of adjustment, does not require to be singed, permitting also at the same time ready replacing of the bristles when worn.

Another stripping and cleaning apparatus for cleaning the flats of revolving flat cards is shown in its section by Fig. 96. The apparatus consists of the combination of a separate wire stripping brush *A* and a separate spiral bristle brush *B*, both of small diameter, carried by two end discs *C*, and revolving or traveling round the axis of a central driving shaft *D*. Both brushes (*A* and *B*) are driven by special gear wheel arrangement in such a manner that they are caused to revolve on their own axes at the same time, and in the same direction as they are traveling round said central driving shaft *D*. A circular comb *E*, also driven by special gear wheel mechanism, is attached, which strips or clears both brushes (*A* and *B*) automatically while the apparatus is at work, and in this manner the two brushes are always kept clean and efficient to perform their work. A hinged guard

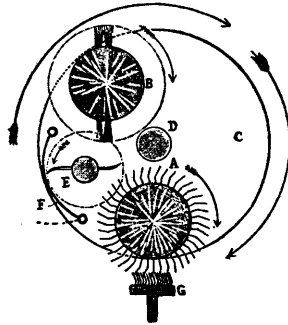


FIG. 96.

Specimen Page of "Cotton Manufacturing, Part 2."  
(Reduced in Size)

COMBING.

5

serves the purpose to keep the slivers better down on the spoons *G*, thus obtaining a prompt action of the stop motion. From the spoons *G*, the slivers pass down a specially shaped guide plate *H*, each sliver being kept separated from the others by means of grooves or channels *I*, through which they pass. The slivers are in this manner brought

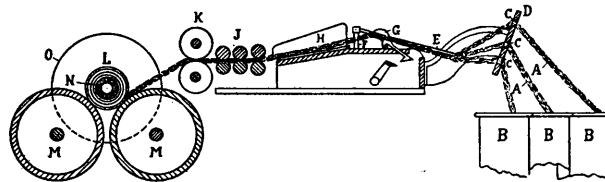


FIG. 106

together and made into a comparatively level sheet without overlapping each other as they enter the series of drawing rolls *J*, side by side. The object of the machine is not to draw the slivers out, but to lay them side by side in the form of an even lap, for which reason the draft in the rollers *J* is just enough to prevent bulkiness of the lap and should not exceed about  $1\frac{1}{4}$  to 2. Emerging from the drawing rolls *J*, the cotton

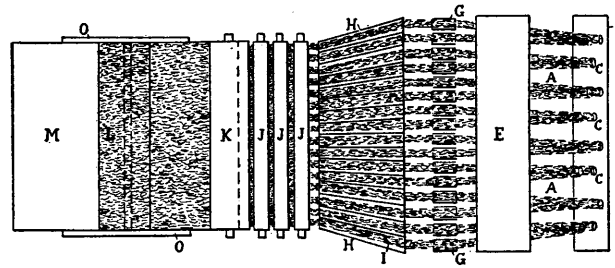


FIG. 107

is conducted between a pair of heavy calender rolls *K*, which compress it into a sheet or lap which enables it to be rolled up. The top calender roller *K* is weighted either by a spring or lever arrangement at each end, with from 80 to 140 lbs. pressure. After the cotton leaves the calender rollers *K*, it is wound in the form of a lap *L*, upon the wooden spool *N*

POSSELT'S TEXTILE LIBRARY, Vol. II.

# WOOL DYEING, Part 1

By WALTER M. GARDNER, F. C. S.

Director of the Dyeing Department of the Textile School in Bradford, England.

*In one Vol., Quarto, Bound in Cloth, Illustrated. Price, \$2.00. Postage prepaid. Delivery guaranteed.*

Table of Contents: Wool Fibre. Wool Scouring. Bleaching of Wool. Water. Mordants. Assistants and other Chemicals. Appendix.

POSSELT'S TEXTILE LIBRARY, Vol. VIII.

# WOOL DYEING, Part 2

By GARDNER and KNAGGS.

*In one Vol., Quarto, Bound in Cloth. Price, \$2.00. Postage prepaid. Delivery guaranteed.*

## ABSTRACT OF CONTENTS:

Classification of Coloring Matters.

### NATURAL DYESTUFFS:

Logwood; Soluble and Insoluble Redwoods; Madder; Cochineal, Kermes and Lac-Dye; Orchil, Cudbear and Allied Coloring Matters.

Yellow Dyes: Weld; Quercitron Bark and Flavin; Persian Berries; Young and Old Fustic; Turmeric; Catechu, Cutch, Gambier.

Indigo.

### ARTIFICIAL DYESTUFFS:

Classification of Coal-Tar Dyes. Artificial Mordant Dyes. Acid Mordant Dyes. Acid Dyes. Direct Cotton Dyes suitable for Wool. Basic Dyes. Dyes applied by Oxidation, Reduction and other Special Processes. Metallic Dyes. Methods for Dyeing Wool in Various Forms. Suitability of Dyes for different Classes of Work. Theory of Dyeing.

*Complete Circulars of both books mailed upon application.*

**Textile Publishing Company**  
2154 North 21st Street Philadelphia, Pa.

# The Jacquard Machine

ANALYZED AND EXPLAINED:

The Preparation of Jacquard Cards and Hints to  
Learners of Jacquard Designing

By E. A. POSSELT

Editor of *Posselt's Textile Journal*.

*In One Vol., Quarto. Bound in Cloth. With 230 Illustrations and Numerous Diagrams. Price, Three Dollars, Postage prepaid, Delivery guaranteed.*

## ABSTRACT OF THE CONTENTS:

### History of the Jacquard Machine.

The Jacquard Machine — General Arrangement and Application.

Illustration of the different parts of the Jacquard Machine — Method of Operation, etc.

The Jacquard Harness — The Comberboards.

### Tying-up of Jacquard Harness.

I.—Straight-through Tie-up.

II.—Straight-through Tie-up for Repeated Effects.

III.—Straight-through Tie-up using Front Harness.

IV.—Centre Tie-up.

V.—Straight-through and Point Tie-ups Combined.

VI.—Straight-through Tie-up in Two Sections.

VII.—Tying-up for Figuring with an Extra Warp

VIII.—Straight-through Tie-up in Three Sections.

IX.—Point Tie-up in Three Sections.

X.—Combination Tie-up in Two Sections.

XI.—Straight-through Tie-up in Four Sections.

XII.—Tying-up with Compound Harness.

XIII.—Tying-up for Gauze Fabrics.

### Modifications of the Single Lift Jacquard Machine.

I.—Double Lift Single Cylinder Jacquard Machine.

II.—Double Lift Double Cylinder Jacquard Machine.

III.—Substitution of Tail-cords for Hooks.

### Tying-up of Jacquard Harness for Two-ply Ingrain Carpet.

Straight-through Tie-up.  
Point Tie-up.

## APPENDIX:

Preparing and Stamping of Jacquard Cards.  
Dobby Card-Punching Machines.

Piano Card-Stamping Machines.  
Stamping, Repeating and Lacing.

## HINTS TO LEARNERS OF JACQUARD DESIGNING:

Point Paper to Use, etc.

Sketching of Designs for Fabrics to be executed on the Jacquard Machine.

Enlarging and Reducing Figures for Sketches

Transferring of the Sketch to the Squared Paper

Outlining in Squares

The Shading of Textile Fabrics by the Weave.

*Complete Circulars mailed upon application.*

**Textile Publishing Company**

2154 North 21st Street

Philadelphia, Pa.

**Specimen Page of "The Jacquard Machine."**  
(Reduced in Size)

$F = 100$  threads.  
 $G = 100$  " (because covering the same distance as  $F$  in part of the fabric.)  
 $F'' = 100$  "  
 $G = 100$  "  


---

400 warp threads in repeat.

$F = 100$  hooks.  
 $F'' = 100$   


---

200 hooks for figure.  


---

4 hooks for weaving the ground, front harness.  


---

204 hooks required to weave design, Fig. XXXIV., repeating with 400 warp-threads.

IV. The Centre Tie-up.

The centre tie-up, also called the point tie-up, has for its purpose the enlargement of the design in fabrics such as table-covers, dressgoods, etc. This tie-up resembles in its principle that of a common point-draw on the harness-loom. After drawing

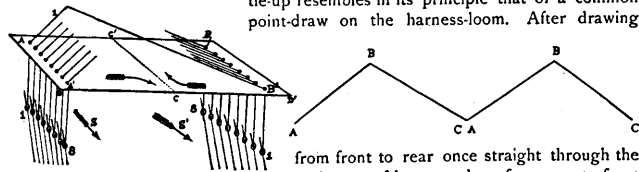


FIG. XXXV.

from front to rear once straight through the entire set of harness, draw from rear to front and repeat. The only difference between harness-work and Jacquard work is in the fact, that with harness we commence to draw in from the first harness straight through to the last,  $A$  to  $B$ , and back again,  $B$  to  $C$ ; but with the Jacquard tie-up on this method this is arranged through the threading of the comber-board, having a straight-through leasing of the heddles and drawing in of the warp.

In Fig. XXXV. there is a clear illustration given of the principle of the centre tie-up on an 8-row comber-board  $A, A', B, B'$ . In laying out the comber board, it must be divided by the line  $C, C'$ , into two equal parts,  $D, C$ , and  $C, D'$ . In the part  $A, A', C, C'$ , of the comber-board, we commence threading with leash 1 at the left-hand rear corner, running in succession towards the centre, as indicated by the arrow on this part of the comber-board.

In part  $B, B', C, C'$ , the threading begins in the opposite corner, to the right-hand in front, with number 1 leash, threading in rotation the number of leashes from the front towards the rear, as again indicated on the figure by an arrow. After leasing and threading the harness, No. 1 leash will contain in its two mails the first and the last of the warp-threads, as indicated in Fig. XXXV. by the numbers, and the rotation by the arrows,  $S$  and  $S'$ .

# American Ribbon Finishing Company

PATERSON, N. J.

Gasoline Finishes, Plain Finishes, Dyeing, Moireing

---

## The Torsion Balance Co.

Calculating Textile Scales

Dyers, Yarn, Cloth, Hosiery, Grain Scales and Weights

*Manufacturers of Special Scales for Special Purposes*

SAN FRANCISCO, CAL. NEW YORK, N. Y., 92 Reade St.

---

F. ROLKER

## RAW SILK IMPORTER

Specialty High Grade Italians  
for Single Weaving

23 EAST 26TH ST.

NEW YORK CITY

---

### H. A. James & Co.

Carded and Combed

### COTTON YARNS

315 Fourth Avenue,  
New York

---

### THOMAS H. BALL

Worsted Yarns

Philadelphia Boston

New York Providence

Ramie Silk  
Artificial Silk

### FREEMAN- SUMNER COMPANY

432 Fourth Ave. NEW YORK

---

### Acme Textile Co.

Artificial Raw and Soft Silk  
Warping, Winding,  
Quilling, Entering  
and Twisting

145 Ellison St., Paterson, N. J.



# THE ROSSENDALE-REDDAWAY BELTING & HOSE CO.

Newark, N. J.

U. S. A.

Manufacturers of

“Camel-Hair” Belting                      “Bird’s Bull’s-eye” Belting  
Hair Belting, “Arabian” Brand  
Solid Woven Cotton Belting, “Blackbird” Brand  
Stitched Canvas Belting                      Linen Fire Hose  
“Sphinx” Brand                      “Red and Blue Line” Brand

## SPECIAL SIZES *for*



Satins, Taffetas, Silk, Mercerized  
and Finished Fabrics.

Silk and Cotton Threads, Worsted  
and Cotton Warps.

Bleached Soluble Oils and Softeners,  
Glues, Gums, Dextrines and Weight-  
ing Materials.

*European Finish on Woolen and Worsted  
Goods Matched*

**The Arabol Manufacturing Co.**  
100 WILLIAM STREET :: :: :: NEW YORK

VULCANIZED FIBRE

## **SILK SHIPPING TRUNKS**

Built to Stand Rough Usage

**JOHN F. WETZEL**

Manufacturer

52 WASHINGTON ST., PATERSON, N. J.

“WETZEL” trunks are protected by a **TWO YEAR** guar-  
antee that makes their purchase a safe investment.

# TEXTILE SOAPS

---

GRAN-CARB-SODA

---

THE HOLBROOK MFG. CO.

Coles & 18th Sts., JERSEY CITY, N. J.

*"The Best is Good Enough"*

---

NICHOLAS SANER

MANUFACTURER OF

LOOM REEDS AND HARNESSSES

AND DEALER IN

SILK MILL SUPPLIES

534-538 WEST 58TH STREET

BETWEEN 10TH AND 11TH AVENUES

NEW YORK

---

WIDMER BROS.

LOOMS

AND ALL KINDS OF

BATTONS

106-114 North 7th St. Paterson, N. J.

Telephones, 4910-4911 Mad. Sq.

## **SPECIALTY SILK CO.**

**SILKS OF ALL DESCRIPTIONS**

On Cops, Cones, Beams, Spools, or in Skeins

**118 East 25th Street New York**

### **H. C. Wahls Mfg. Co.**

**NARROW RIBBONS  
BINDINGS and GALLOONS  
122-124 East 25th St., New York**

### **JOSEPH LOTH & CO.**

**Manufacturers of  
RIBBONS AND NARROW  
WOVEN FABRICS  
117 East 23rd St., New York**

### **Mindlin & Rosenman**

105-107 E. 29th St., New York

**THROWN SILK  
ARTIFICIAL SILK**

**Tinsel Thread, Mercerized  
and Cotton Yarns**

Mills—Long Island City, N. Y

## **CRITERION DYE WORKS, Inc.**

**TEXTILE DYERS**

*Specialty: Yarn-Dye Re-Dye*

**NEW YORK CITY**

Tel. Chelsea 2619

511 West 30th Street

## **Malcolm Mills Company**

**Orchard & Church Sts., Phila.**

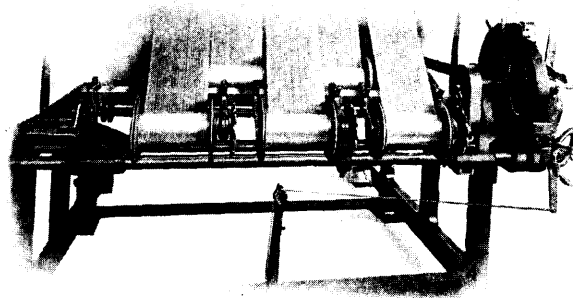
**GLAZED THREADS, TINSELS,  
BRILLIANTS, NOVELTY YARNS**

## **Pennsylvania Ribbon Finishing and Watering Co.**

**414 E. Allegheny Ave. PHILADELPHIA**

**Finishing and Watering of all Narrow Fabrics and Ribbons.**

## Adjustable Ribbon Warp Beamer for Straight or Swiss Motion



One of the most important factors in ribbon weaving is a perfect beamed warp. By use of the Swiss Motion in the making of warps for ribbons, imperfections like loose and tight ends, stickers, splits and other warp defects are obviated, with the result that section marks are eliminated in ribbons the same as they have been heretofore in connection with broad fabrics.

By the adoption of the **Kuenneth Beamer System**, which may be applied either to a Swiss Motion Frame or a Straight Frame, without requiring any alterations in either make of machine, the advantages previously mentioned, as well as others are secured.

This Kuenneth beamer system, and of which a perspective view is herewith given, is adjustable as a whole, or for sections, and can be applied to any make of warper without having to alter its frame or beam. The attaching and adjusting of the new device can be done in a short time.

The beams by the use of this Kuenneth system can be moved back and forth without loosening the driving attachment and can be taken up or released at the will of the operator. The sections may be reduced or increased as circumstances require without loss of time.

The complete beam may be turned to any advantageous angle for the operator, so that the warps are always perfectly accessible and easy to handle.

When warp beams of over four inches inside of flanges are used, a solid warp is then run across the reel, saving in time and space.

After Swiss motion made ribbon warps will become known to the ribbon industry, many classes and grades of ribbons which are made now with a straight system as well as the drop weight system will then be made by it, on account of the many advantages of the Kuenneth System.

*For additional information, prices, etc., address the  
builders of the device, the*

### **Morrison Machine Company**

**MANUFACTURERS OF SILK PRINTING, FINISHING  
AND DYEING MACHINERY**

**204 Van Houten Street,**

**PATERSON, N. J.**

**Permutit**  
TRADE MARK  
REG. U. S. PAT. OFF.

**The Water Softening Filter to Zero Hardness**

**The largest Narrow Fabric Manufacturer in the World says:**

"I decided upon **PERMUTIT** because I know what can be done with absolutely soft water. The little tricks in finishing, the short cuts possible, the fewer spoiled goods."

*Send for the Literature on Permutit*

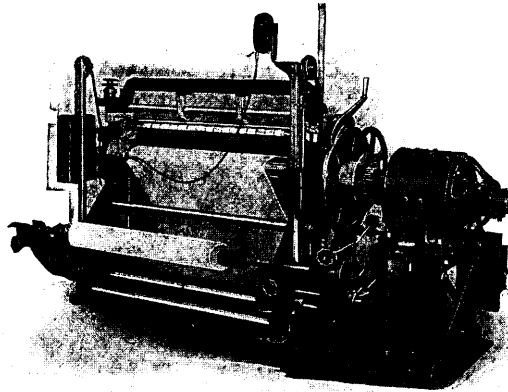
**THE PERMUTIT COMPANY**  
**30 East 42nd St. New York**

**W. W. UHLINGER PATENT  
WARP LET-OFF  
FOR GERMAN LOOMS**

Increases production about 10%.  
Produces evener and cleaner goods.  
Less breaking of warp ends; the warps are always the same length and the weights are always in the same position.  
Will let-off equally as well in damp weather as in dry weather.  
Can let warps back without going back of the loom.  
Same weights and warp pulley hangers as you now use.  
Very successful in wide ribbons where the ground warp is on beams; edges, binders, etc., being on spools.

For descriptive matter of the Construction and Operation of this Warp Let-off, see pages 188 to and inclusive 192 of this book.

**W. W. UHLINGER**  
**202 Paterson Street PATERSON, N. J.**  
Manufacturer of Patent Self Let-off Motions for Ribbon Looms, Patent Filling Stop Motions for Broad Looms, Direct Warping Machines and other Textile Machinery and Appliances.



## **CAMERON PRINCIPLE SLITTING AND REWINDING MACHINE**

for converting wide webs of any kind of material into strips of any width and rolling up the strips into firm coils all at one operation, and this at high speed.

### **The Same Machine**

is also the ideal rolling up machine for wide webs required to be put up in the form of firm even rolls. Increase in sales and profits await the manufacturers and wholesalers who are willing to oblige customers by putting up their goods in form most convenient to handle.

*Send for illustrated Catalog*

---

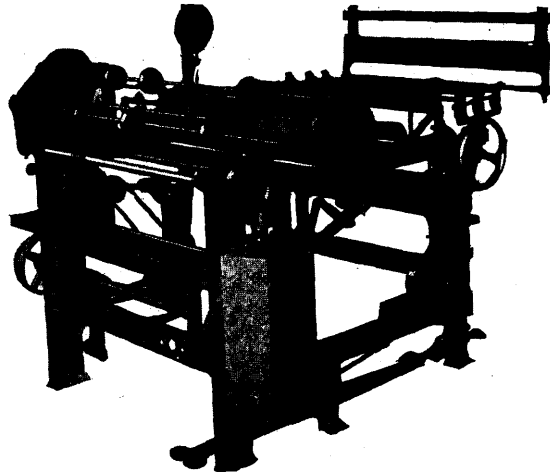
**Cameron Machine Company**

57-61 Poplar St.

BROOKLYN, N. Y.

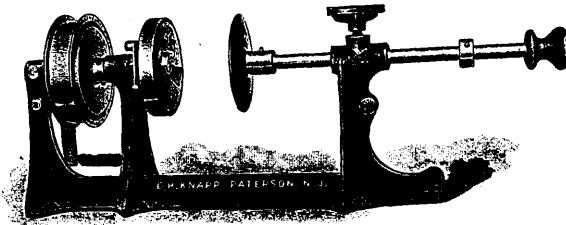
## **WARPING MACHINE**

**For Making Ribbon Warps on Spools**



The Spool Travers is adjustable to different lengths of spool, while machine is running.  
Warpers for all kinds of Narrow Ware Fabrics.

## **RIBBON BLOCKER**



"Sure grip chuck," adjustable to any size block or tube. Made to grip inside of a tube or outside of a block For all Kinds of Goods that are put up in Rolls.

**CHAS. H. KNAPP**

WAIT and RYE STS.,

PATERSON, N. J