

Fig. 4

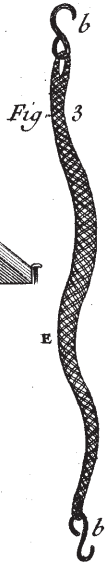

Fig. 3

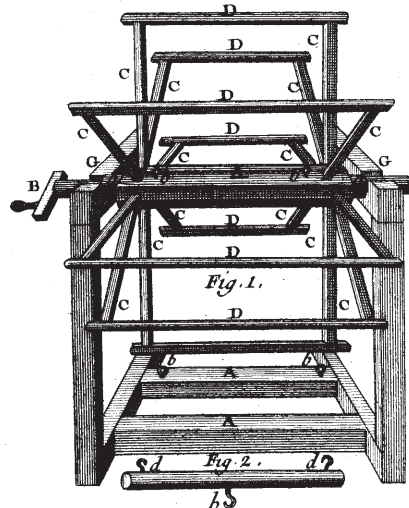

Fig. 1.

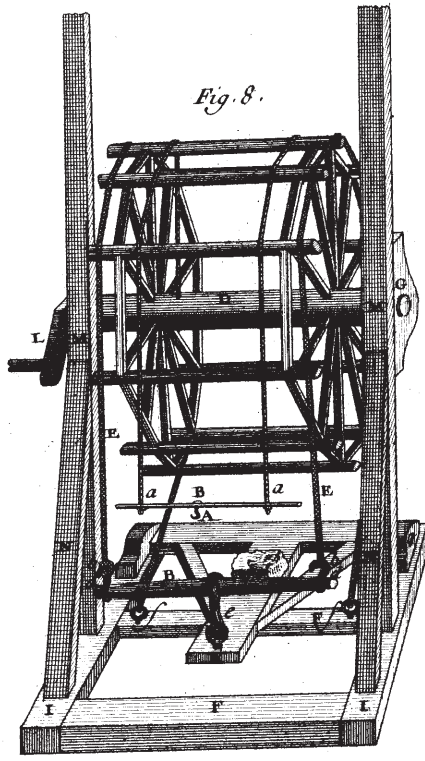

Fig. 8.

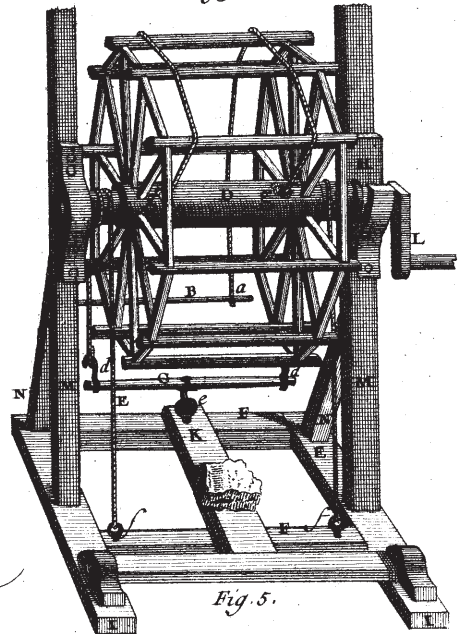

Fig. 5.



Fig. 7

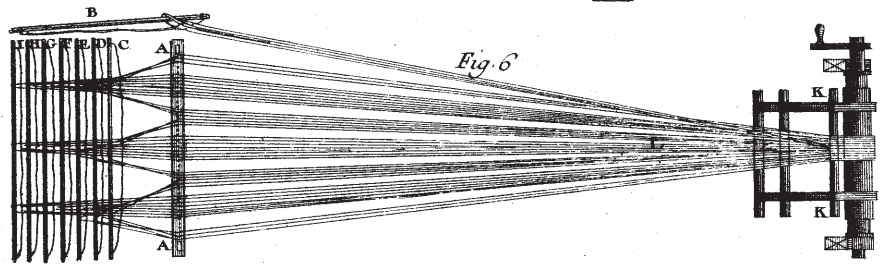
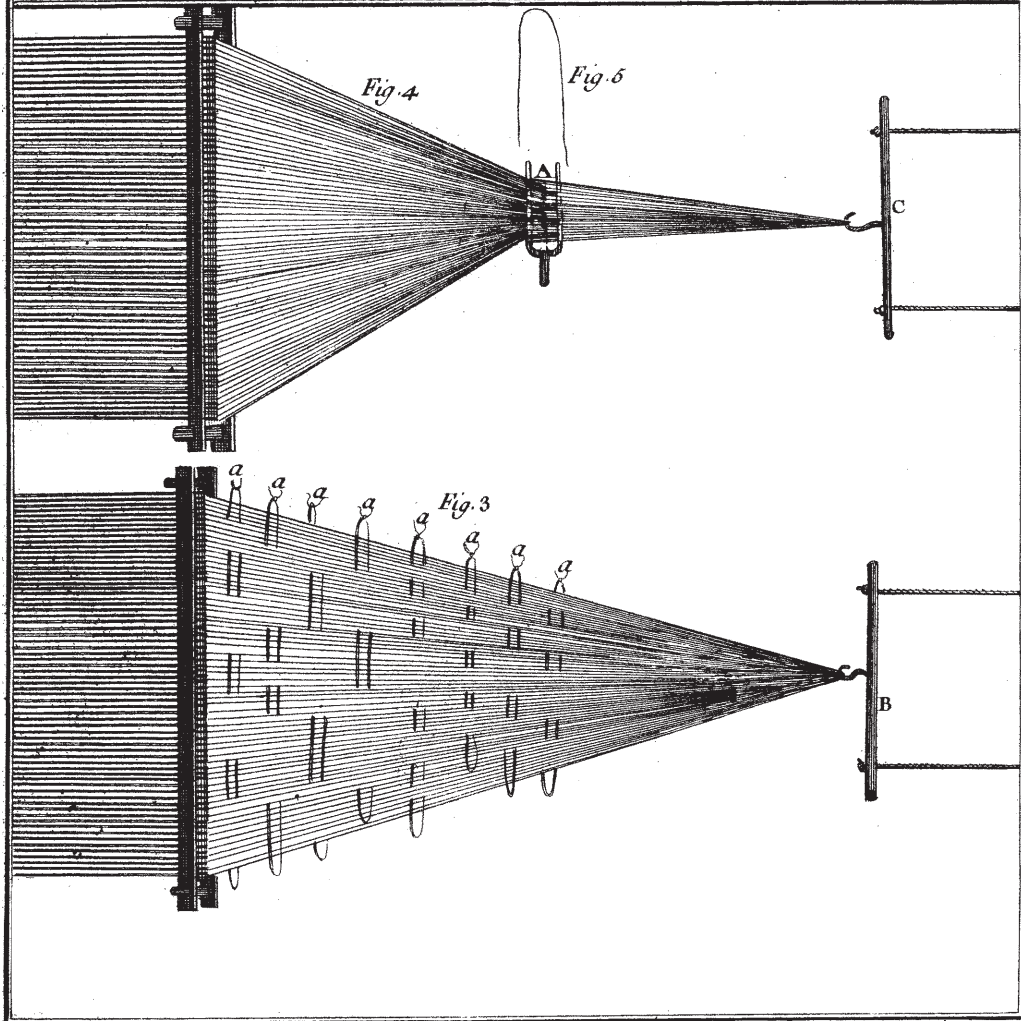
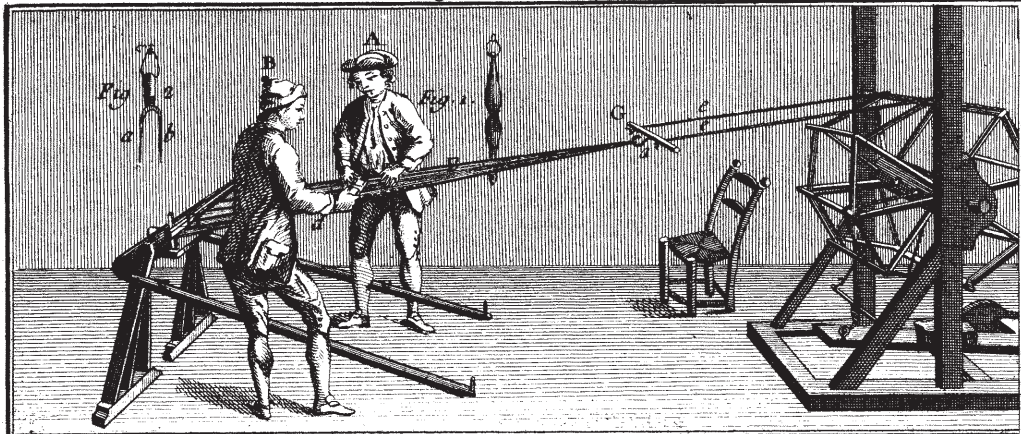
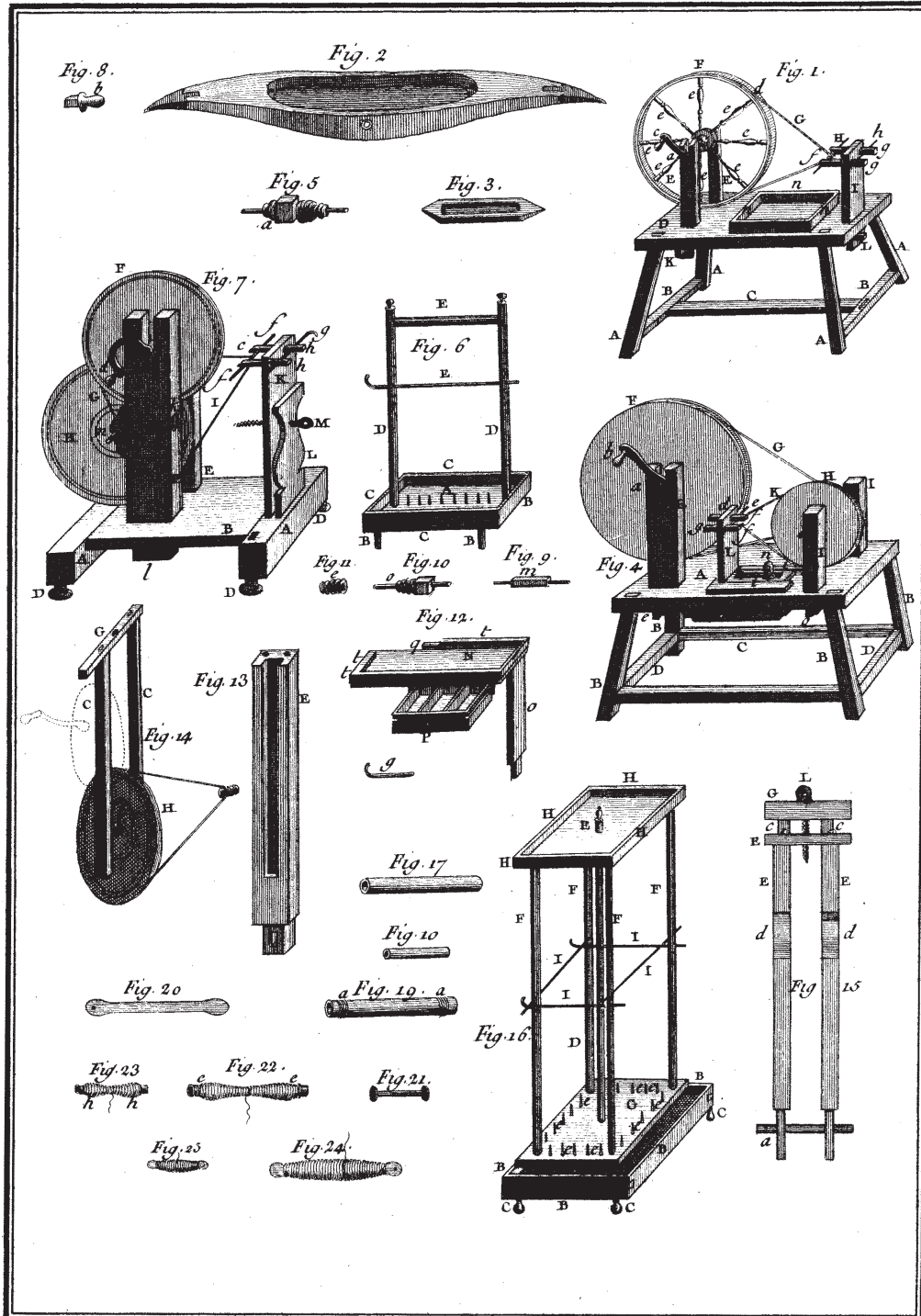
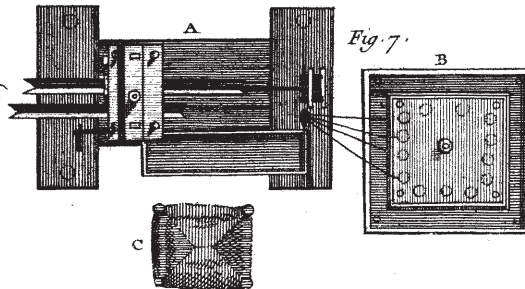
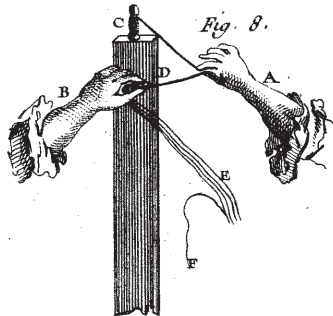
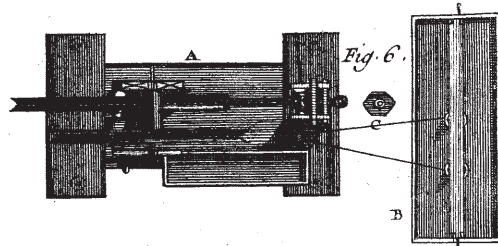
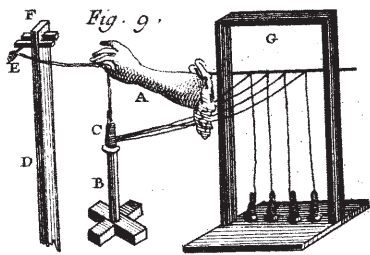
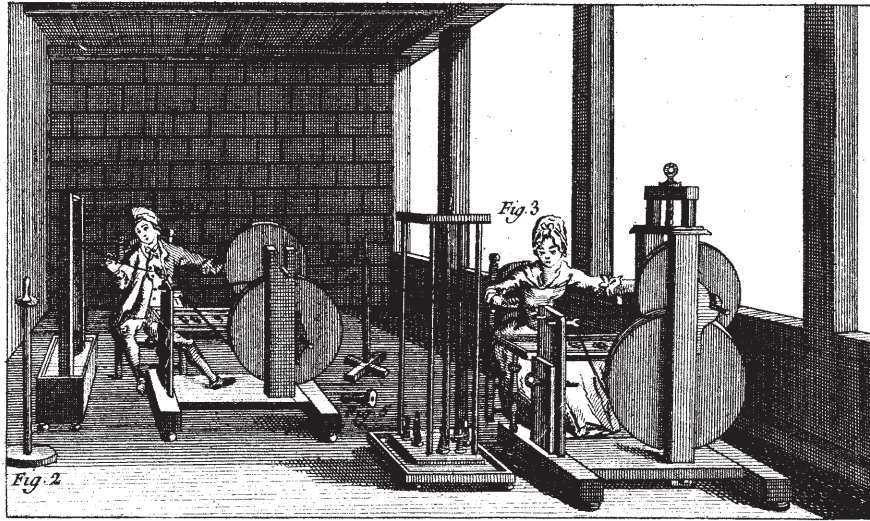
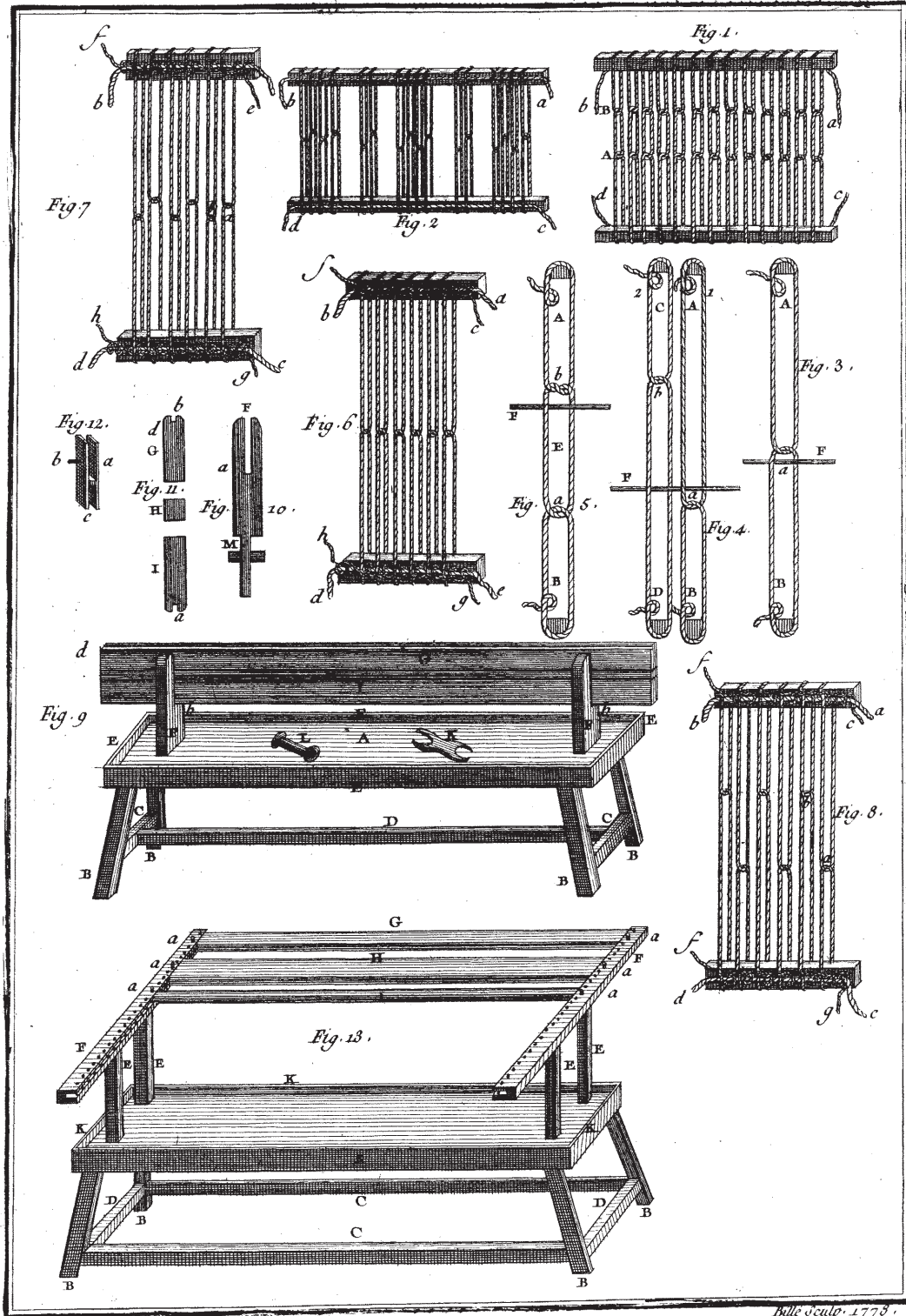

Fig. 6









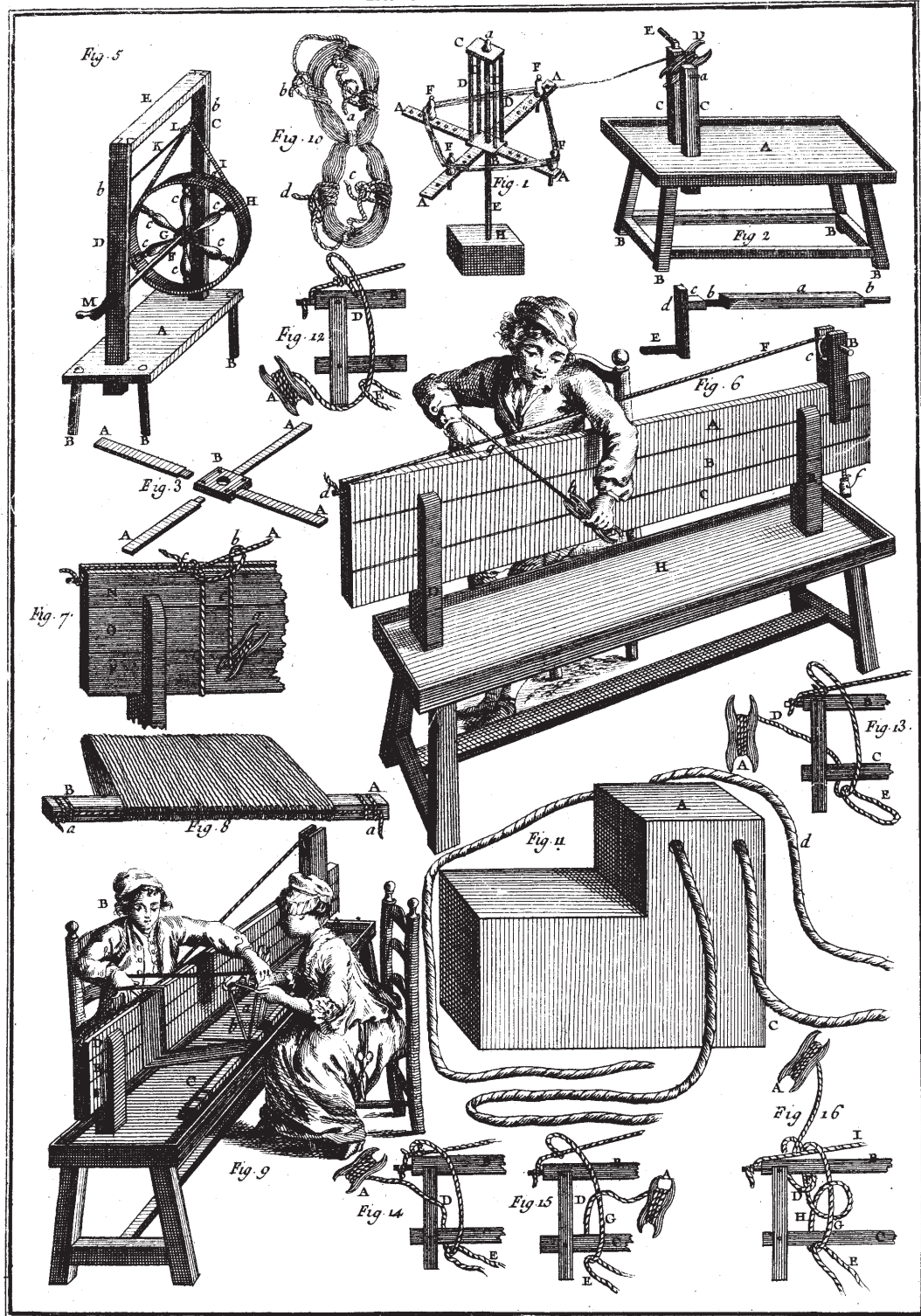



Fig. 1.

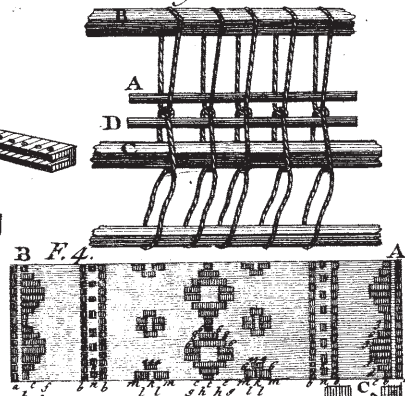

Fig. 7.



Fig. 3.

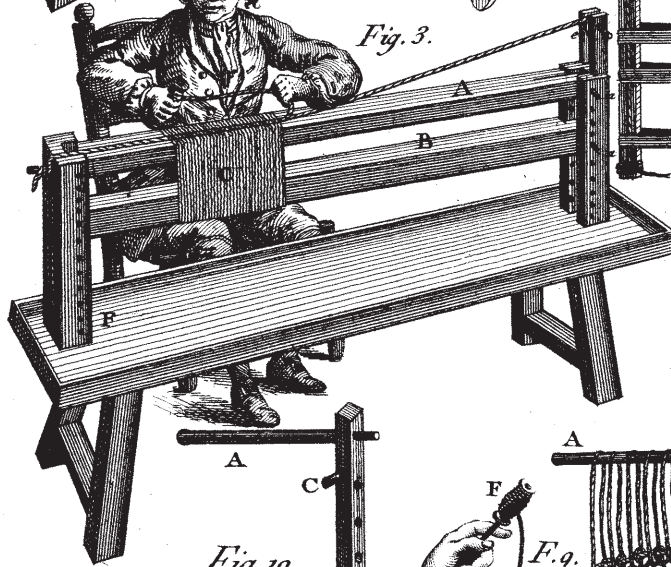

Fig. 6

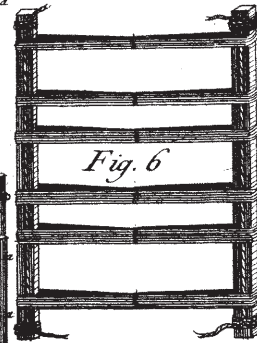

Fig. 8.

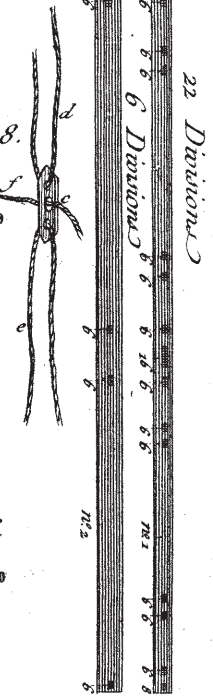

Fig. 10.

