

Fig. 3.

Zackschaf.

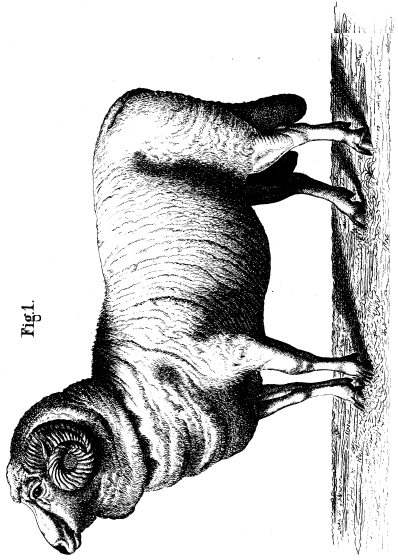

Fig. 1.

Merinoschaf.

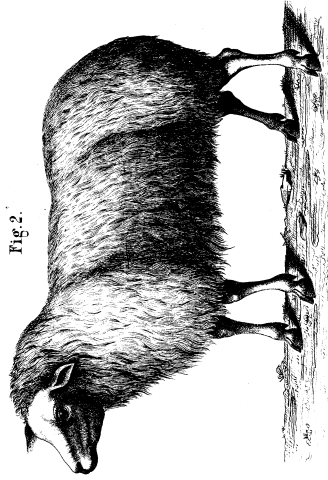

Fig. 2.

Chevotschaf.

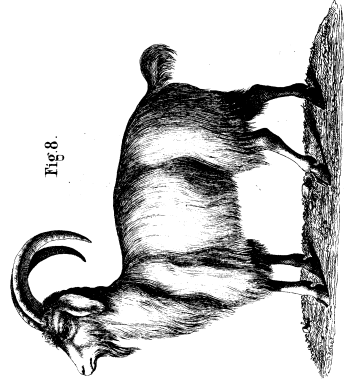

Fig. 8.

Angoraziege.

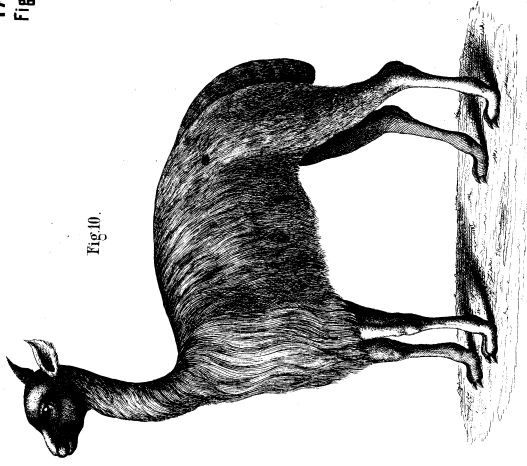

Fig. 10.

Vikona.

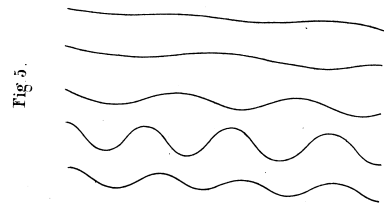

Fig. 5.



Fig. 4.

Schafwollhaar,
400 mal vergr.



Fig. 6.

Haar der Angoraziege,
400 mal vergr.

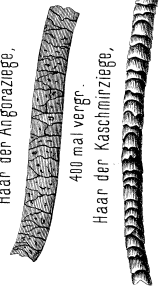

Haar der Kaschmirziege,
400 mal vergr.

Fig. 7.

Fig. 9.

Viggewolle,
400 mal vergr.



Fig. 11.

Pferdehaar, (400 mal vergr.)

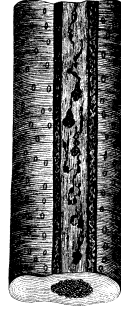
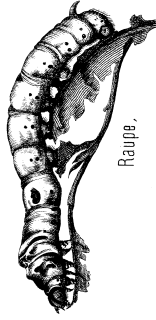

Fig. 12.

Seidenspinner,



Raupe,

Fig. 14.



nat. Gr.

Cocon.

Fig. 13.



Puppe,

Fig. 15.



Falter.

TAF. 2.
Fig. 16-28.



Fig. 16.

Baumwoll-Pflanze.

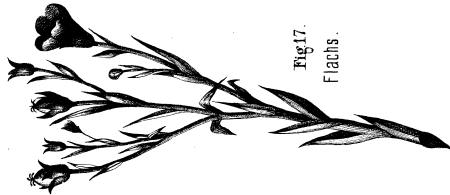

Fig. 17.

Flachs.



Fig. 18.

b

Hanf.



a

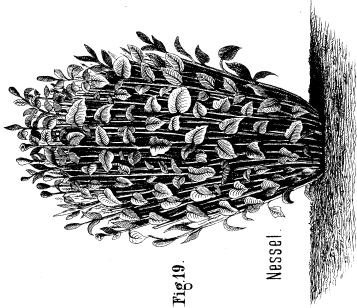
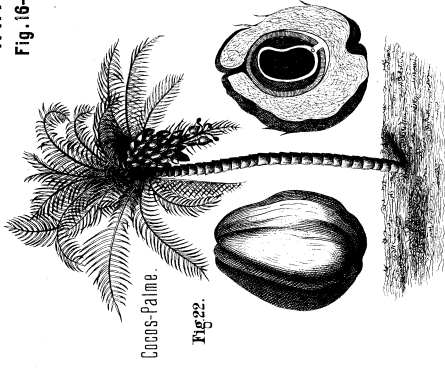

Fig. 19.

Nessel.



Cocos-Palme.

Fig. 22.

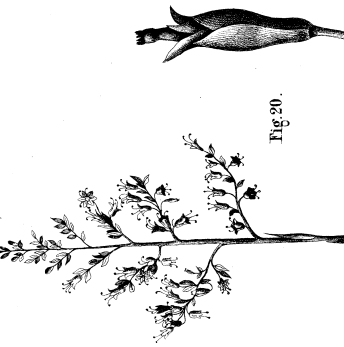

Fig. 20.

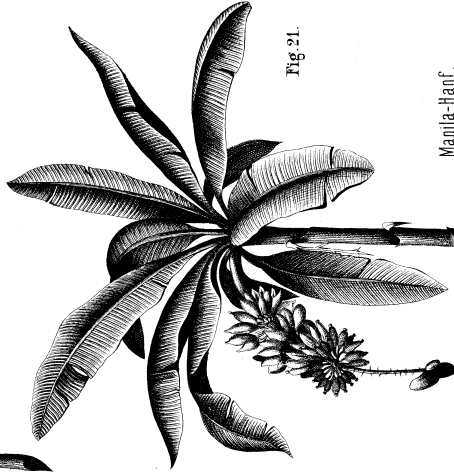
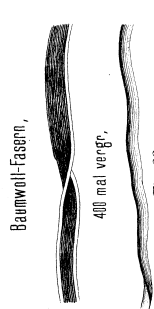

Fig. 21.

Mamia-Hanf.



Baumwoll-Fasern,

400 mal vergr.

Fig. 23.

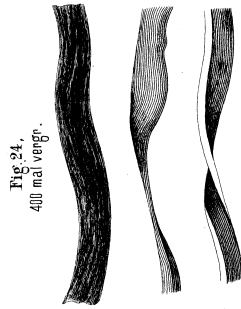

Jute-Fasern,

400 mal vergr.

Fig. 24.

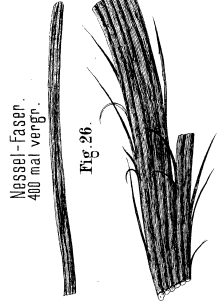

Nessel-Fasern,

400 mal vergr.

Fig. 26.



Flachsfasern,

400 mal vergr.

Fig. 27.

a



Hanf-Fasern,

400 mal vergr.

Fig. 28.

b

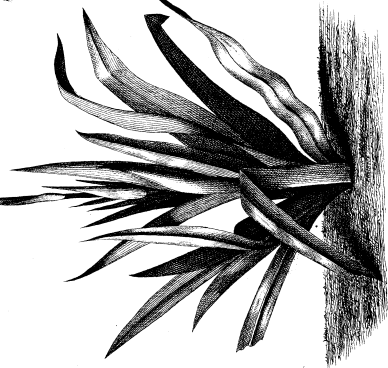

Neuseeländischer Flachs

Jute-Fasern,

400 mal vergr.

Fig. 25.

TAF. 3.
Fig. 29-38.

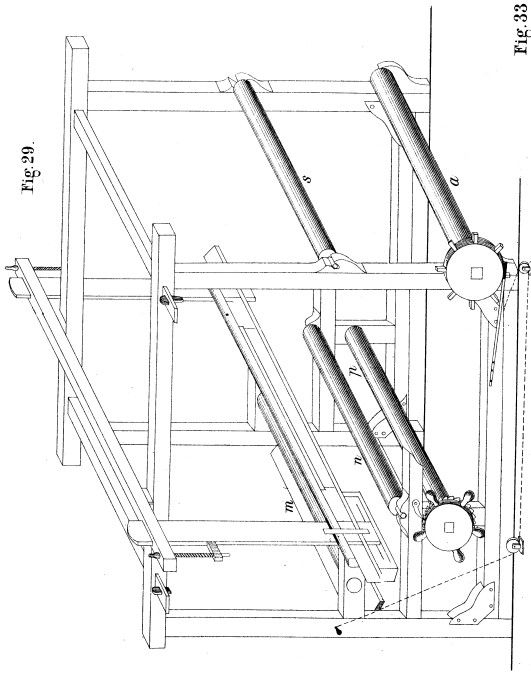

Fig. 29.

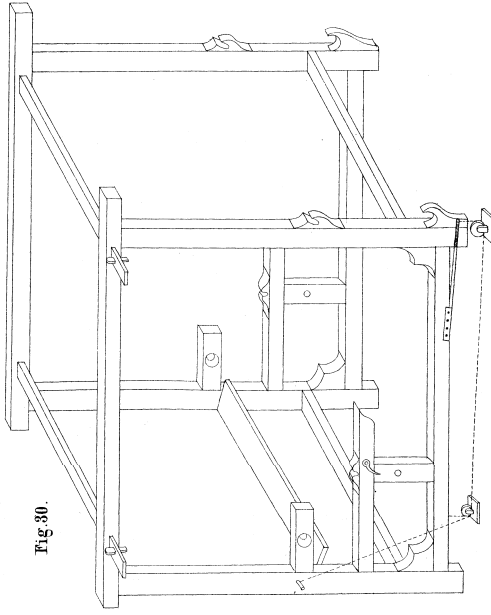

Fig. 30.

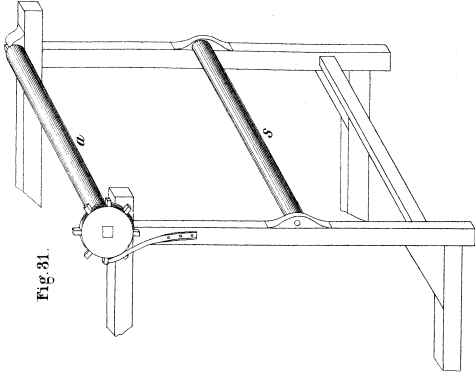

Fig. 31.

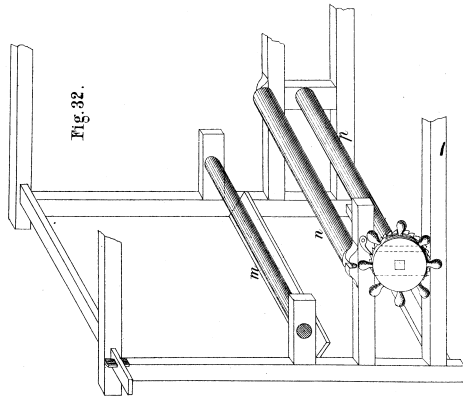

Fig. 32.

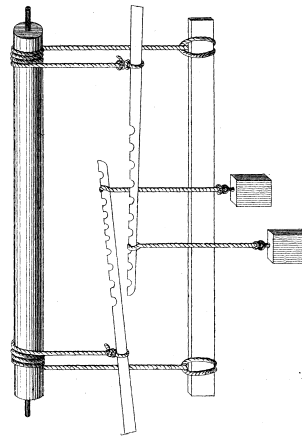

Fig. 33.

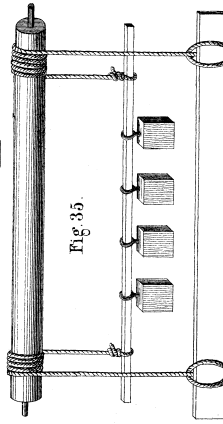

Fig. 35.

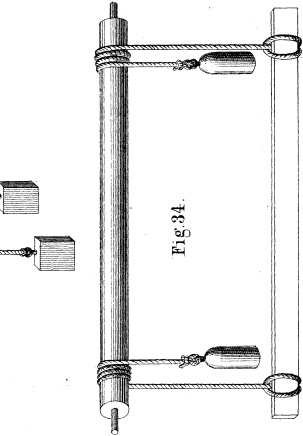

Fig. 34.

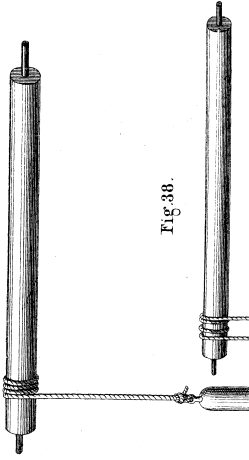

Fig. 37.

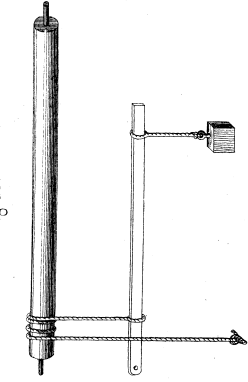

Fig. 38.

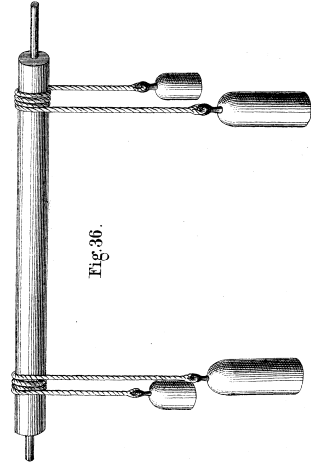
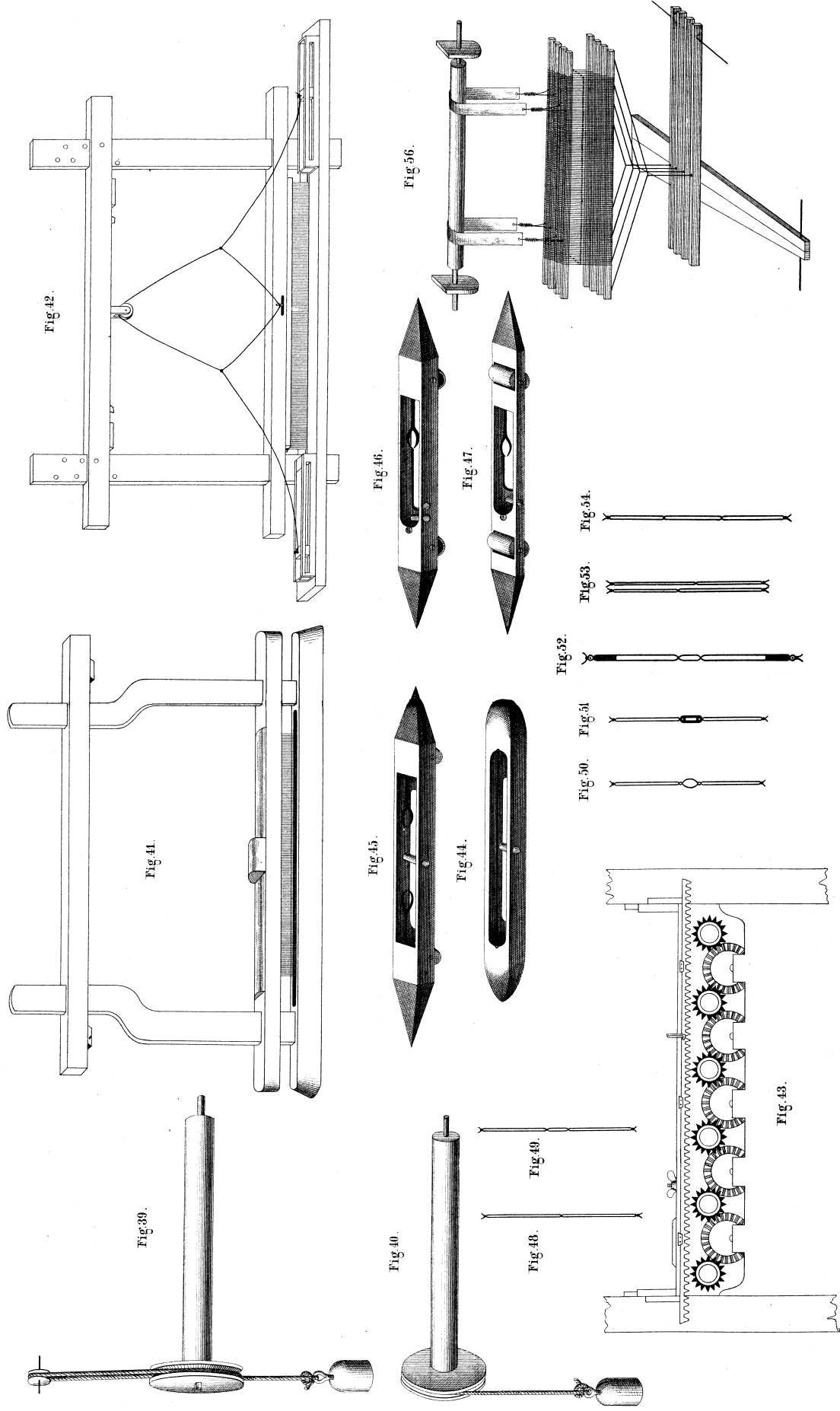
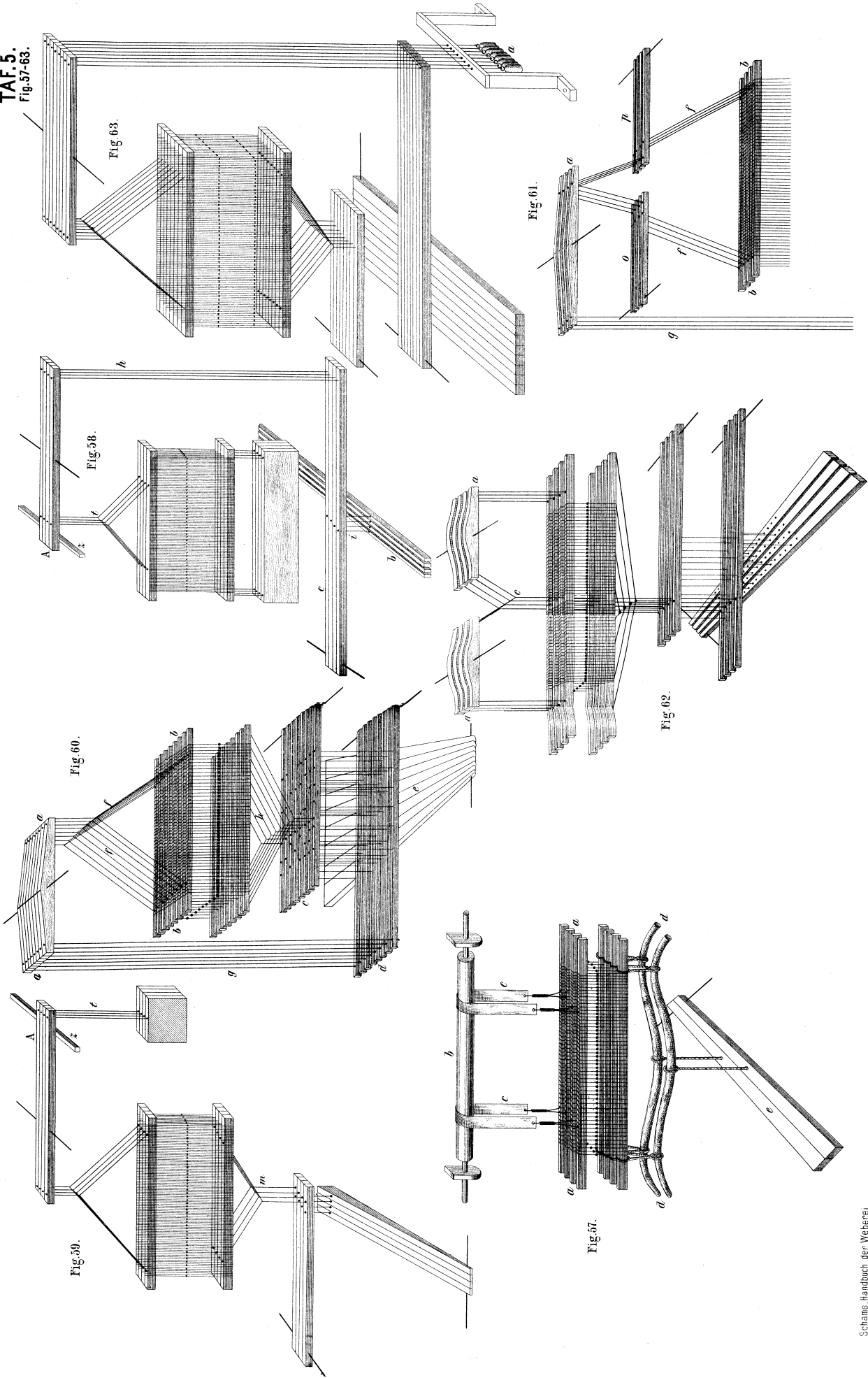

Fig. 36.



TAF. 5.
Fig. 57-63.



TAF. 6.
Fig. 64-71.

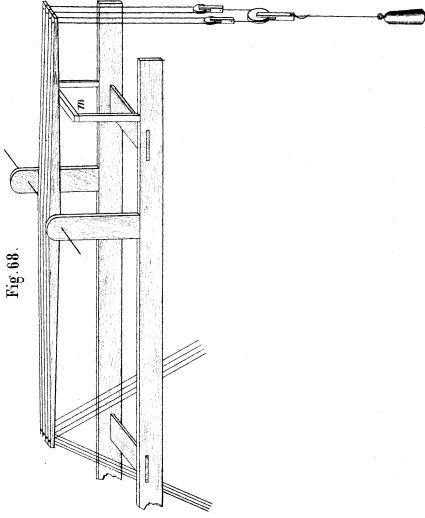

Fig. 68.

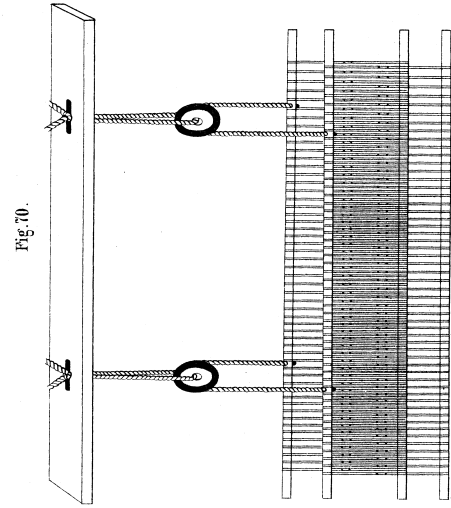

Fig. 70.

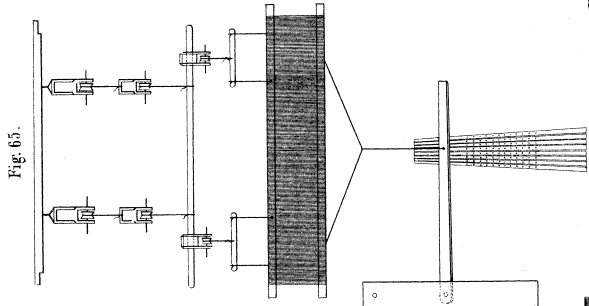

Fig. 65.

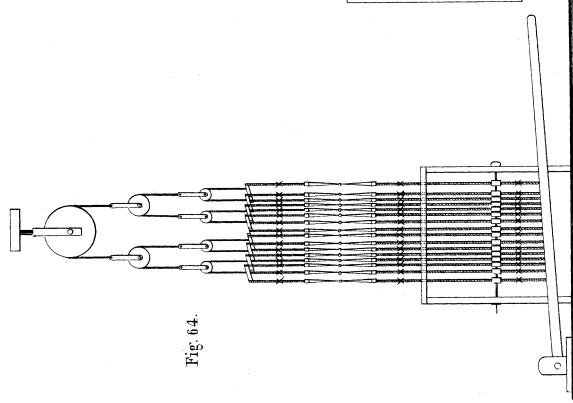

Fig. 64.

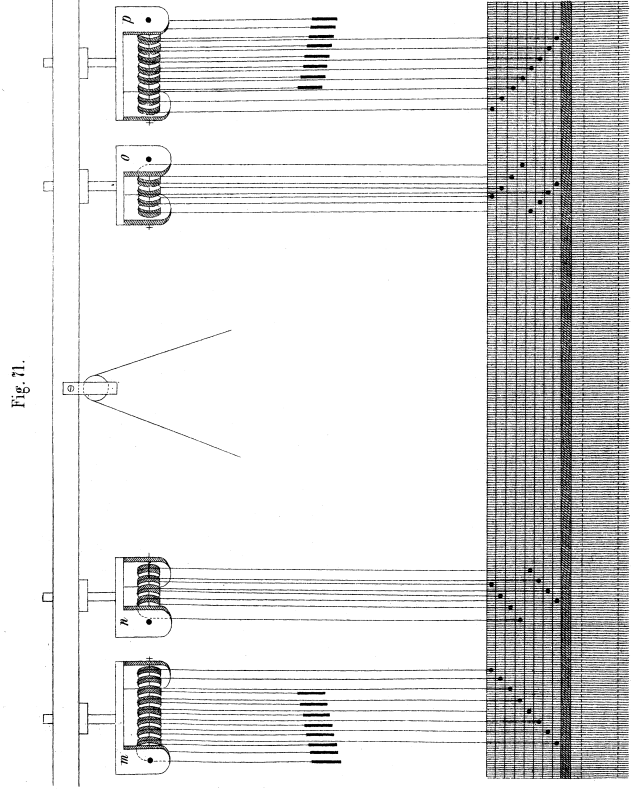

Fig. 71.

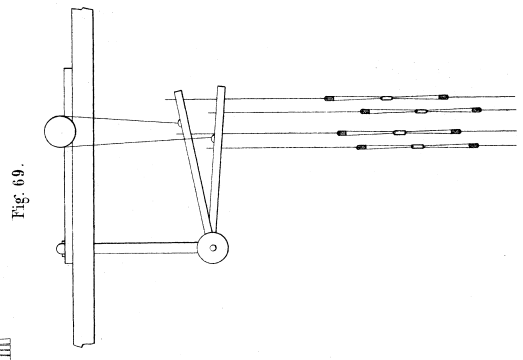

Fig. 69.

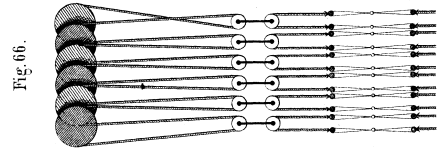

Fig. 66.

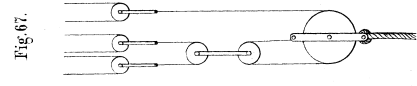
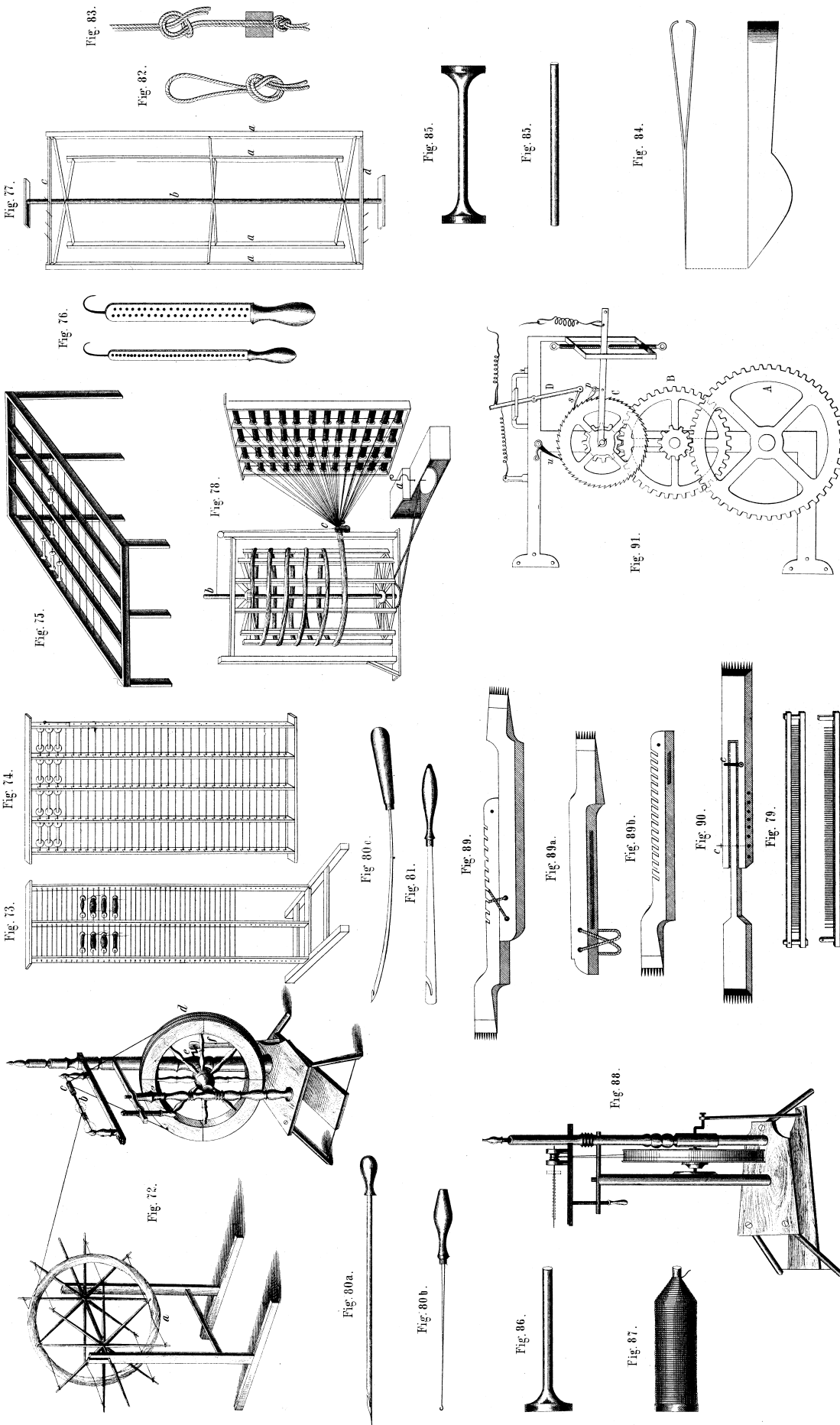

Fig. 67.

TAF. 7.
Fig. 72-91.



TAF. 8.

Fig. 92 - 108.

Fig. 96.

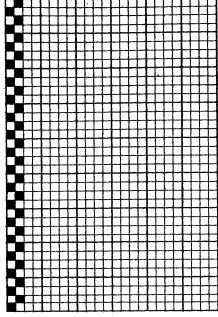

Fig. 95.

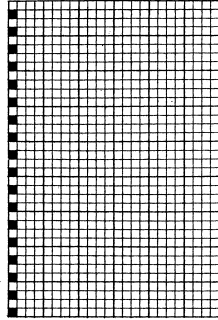

Fig. 92.

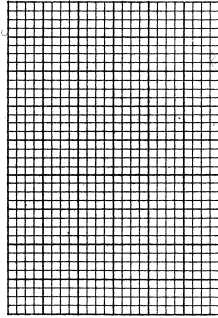

Fig. 94.

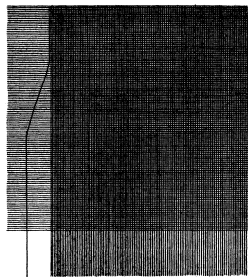

Fig. 93.

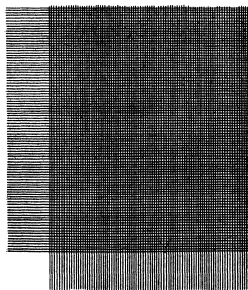

Fig. 101.

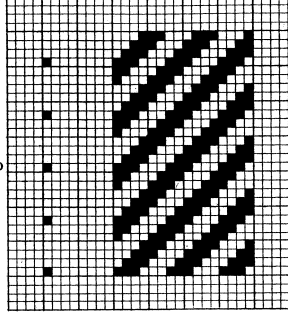

Fig. 100.

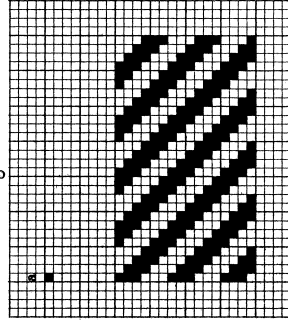

Fig. 99.

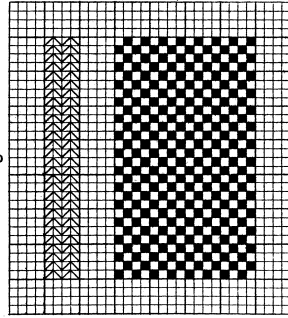

Fig. 98.

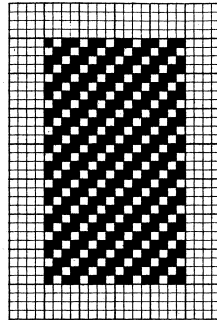

Fig. 97.

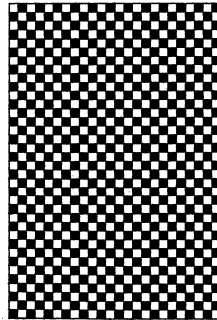

Fig. 103a.

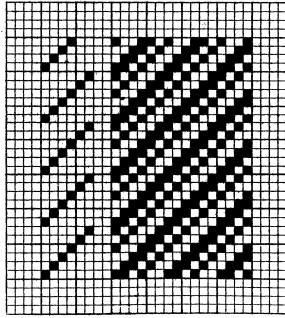

Fig. 105. b.

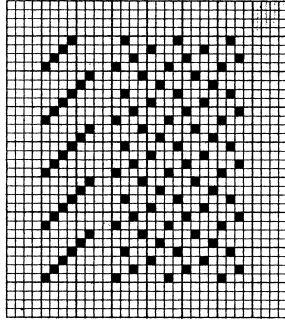

Fig. 104.

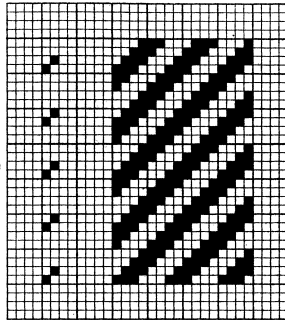

Fig. 102.

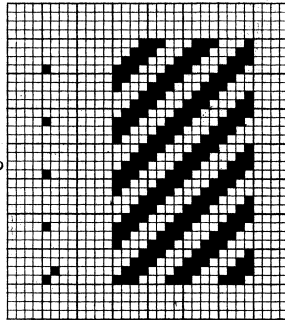

Fig. 109.

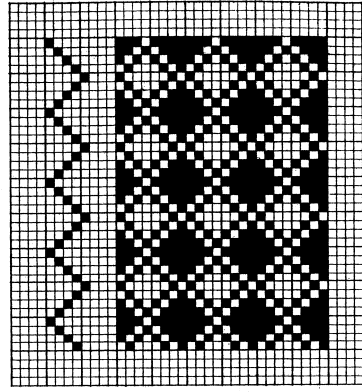

Fig. 108.

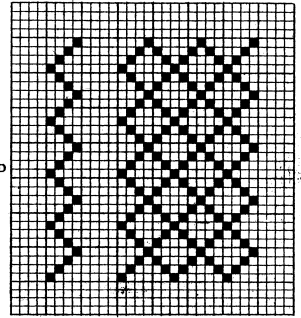

Fig. 107.

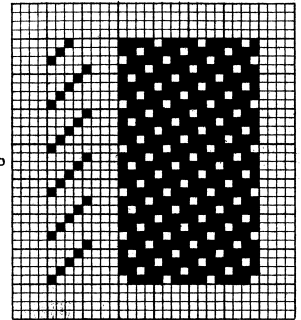
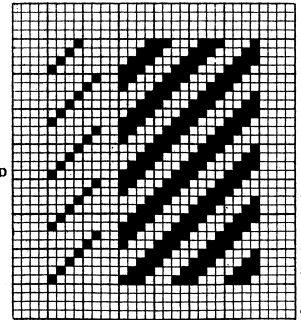

Fig. 106.



TAF. 9.
Fig. 110-122.

Fig. 110.

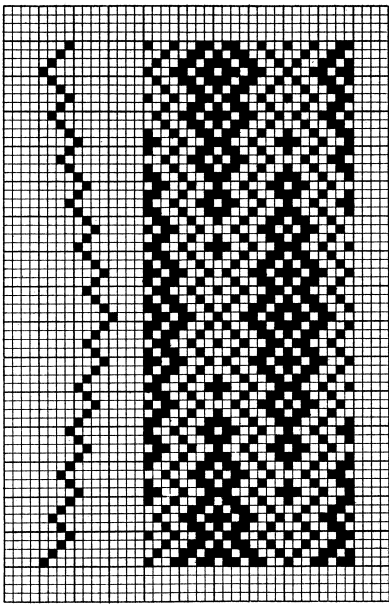

Fig. 115.

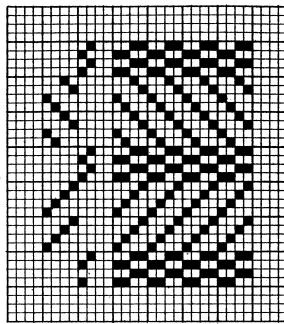

Fig. 116.

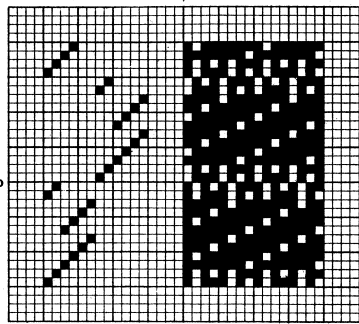

Fig. 111.

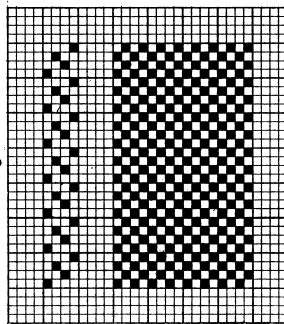

Fig. 113.

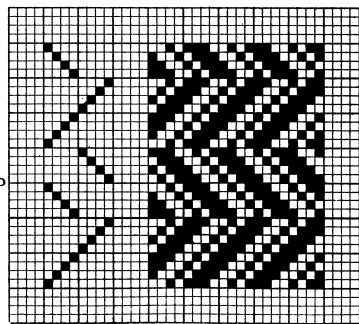

Fig. 112.

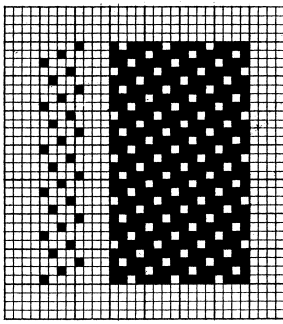

Fig. 114.

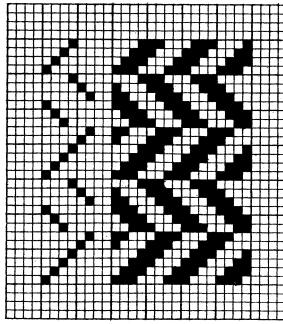

Fig. 117.

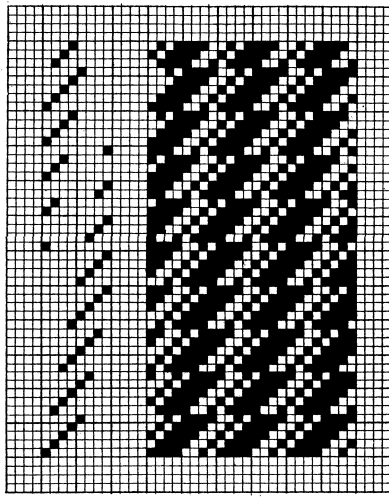

Fig. 121.

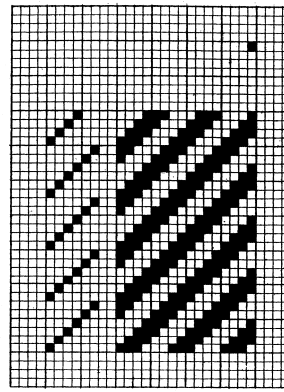

Fig. 119.

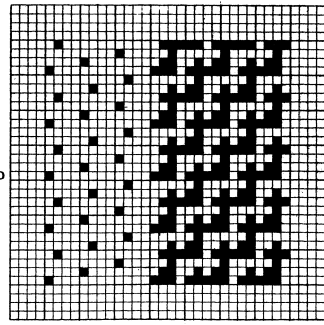

Fig. 118.

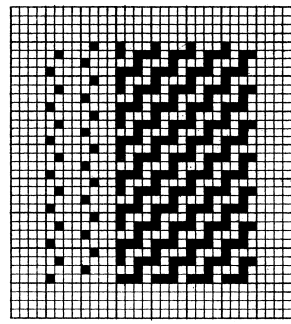

Fig. 122.

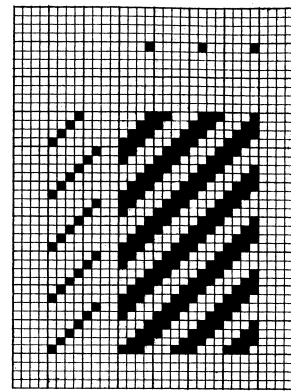
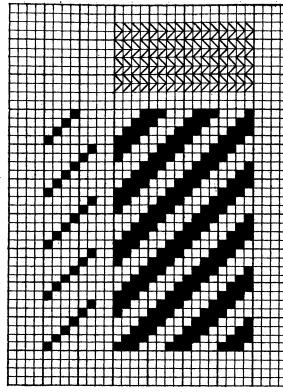

Fig. 120.



TAF. 10.
Fig. 123 - 134.

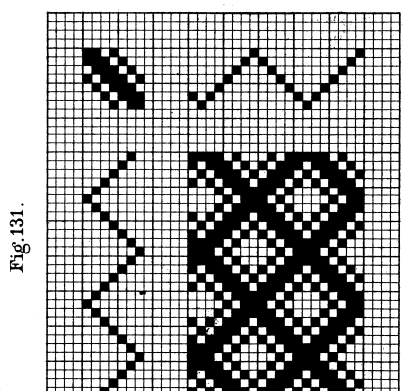
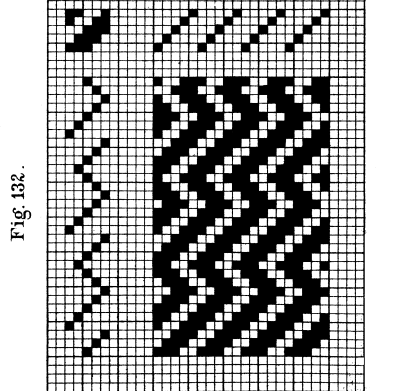
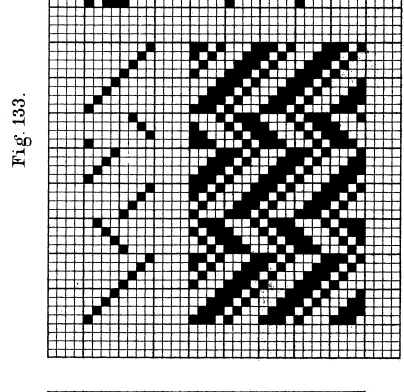
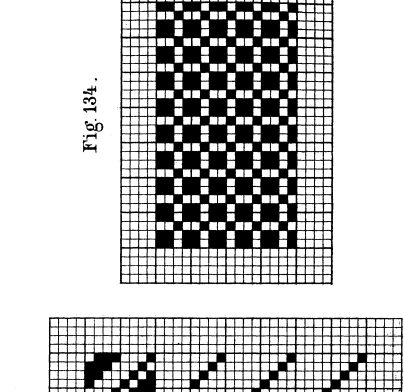
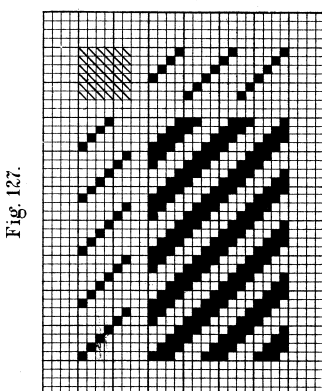
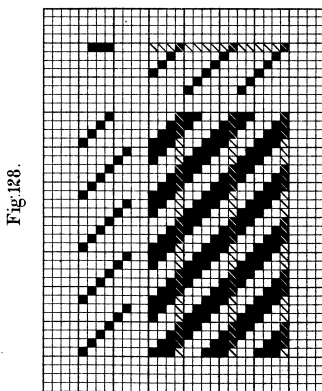
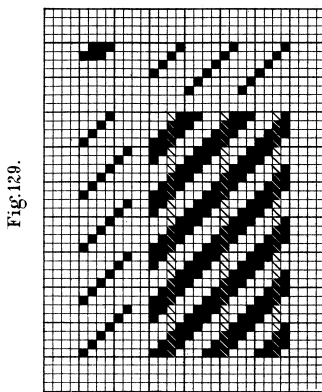
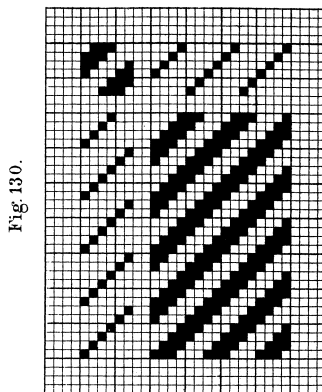
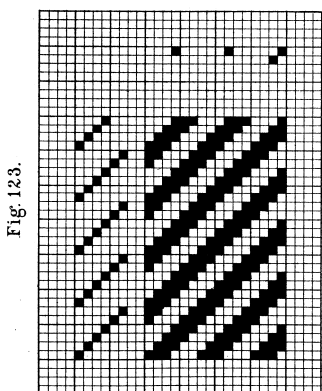
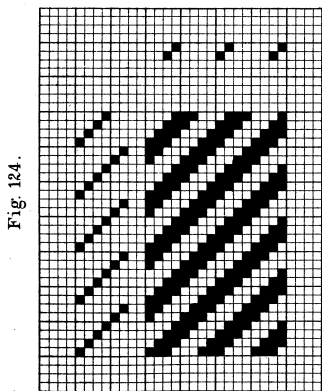
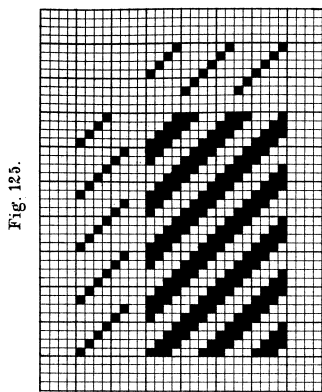
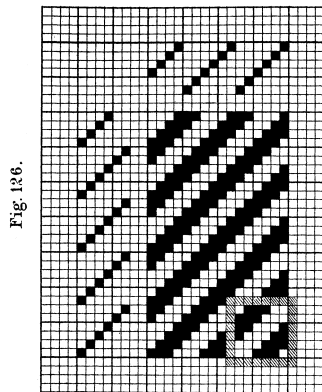

Fig. 135.

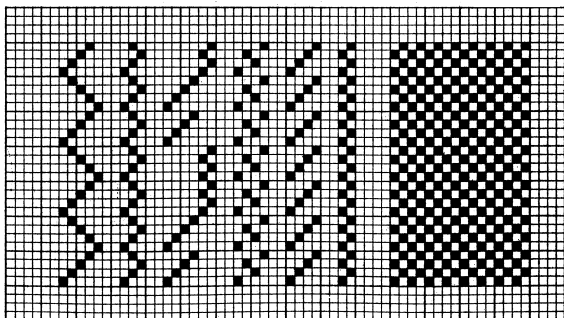

Fig. 136.

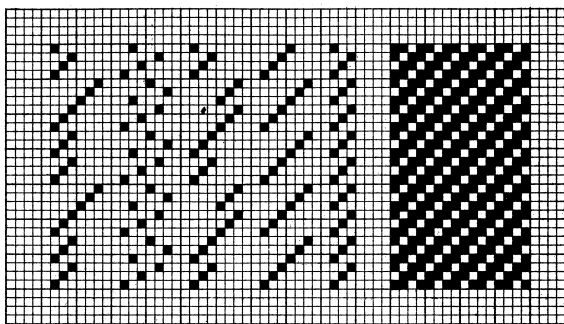

Fig. 137.

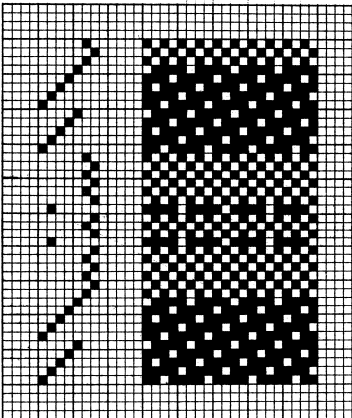

Fig. 138.

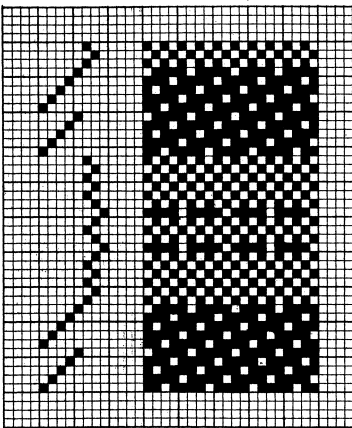

Fig. 140 a.

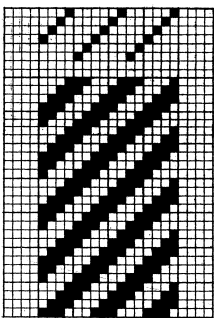

Fig. 140 b.

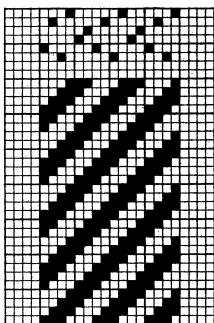

Fig. 142.

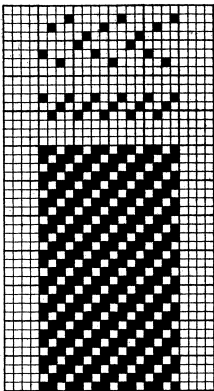

Fig. 139 a.

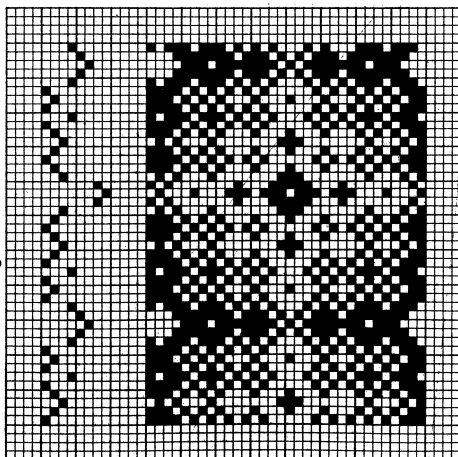

Fig. 139 b.

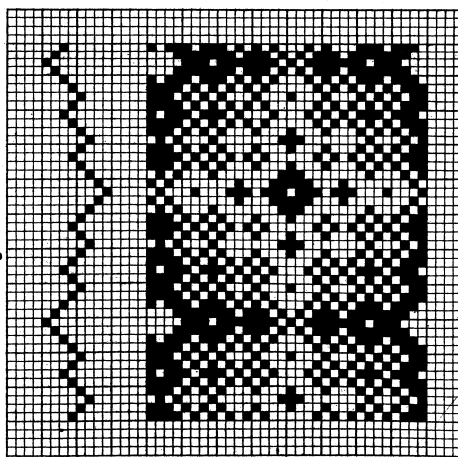

Fig. 141 a.

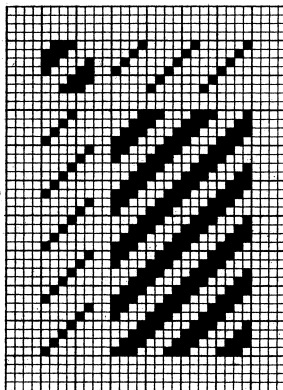

Fig. 141 b.

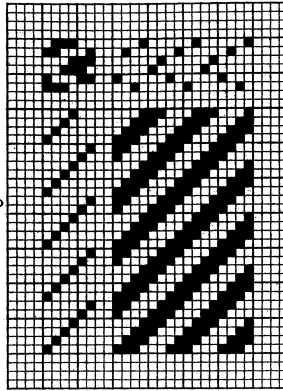
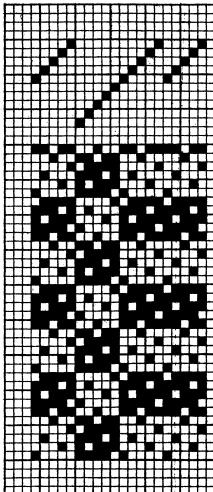

Fig. 143.



TAF. 12.
Fig. 144 - 163.

Fig. 144.

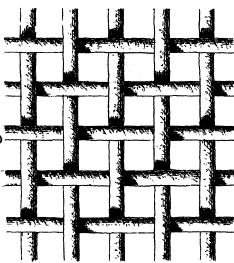

Fig. 149.

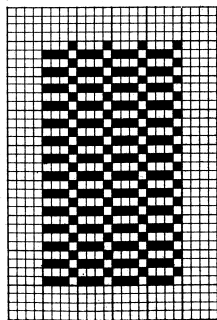

Fig. 154.

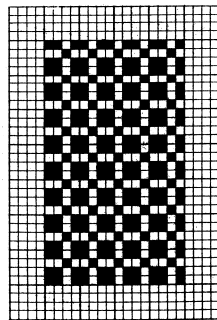

Fig. 159.

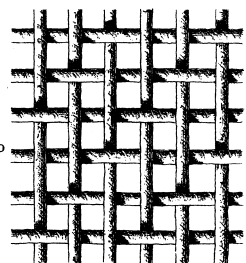

Fig. 145.

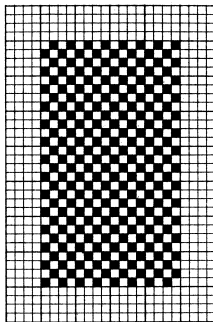

Fig. 150.

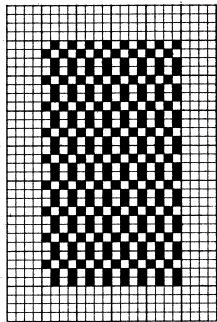

Fig. 155.

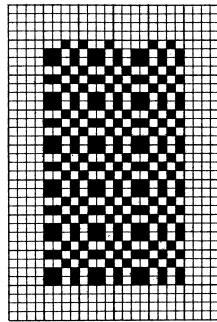

Fig. 160.

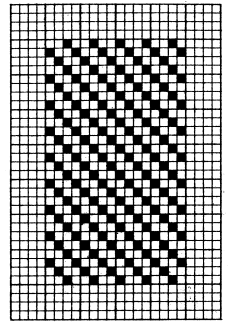

Fig. 146.

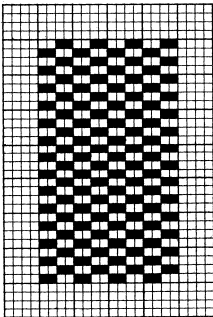

Fig. 151.

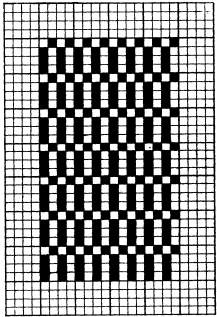

Fig. 156.

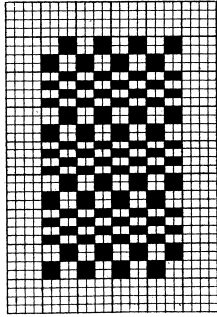

Fig. 161.

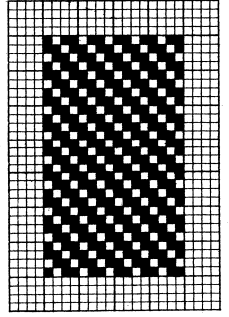

Fig. 147.

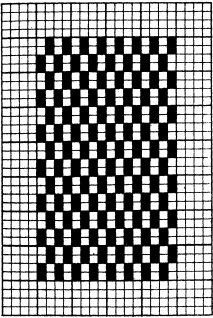

Fig. 152.

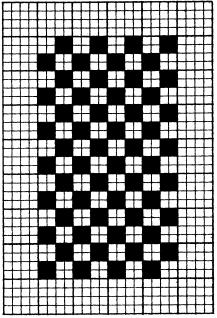

Fig. 157.

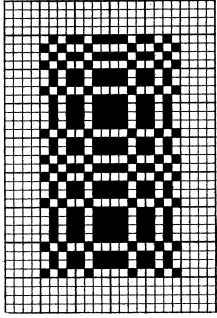

Fig. 162.

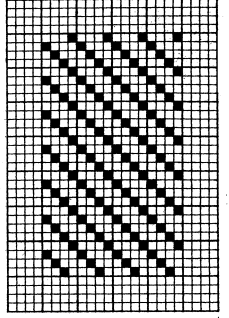

Fig. 148.

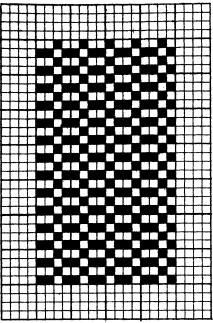

Fig. 153.

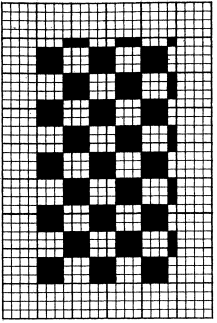

Fig. 158.

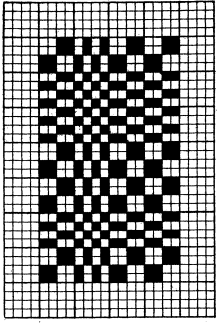
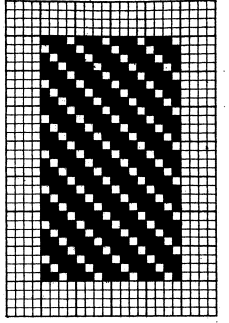

Fig. 163.



TAF. 13.

Fig. 168. Fig. 164-183.

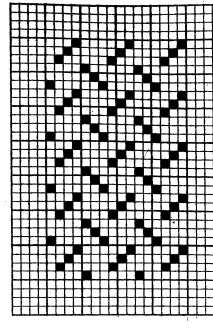
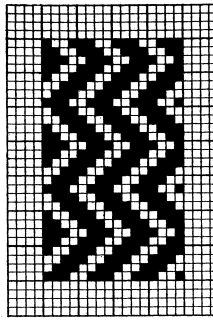
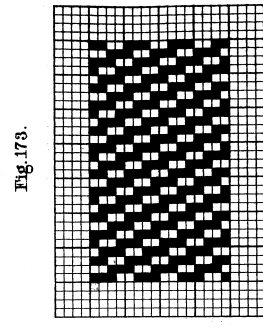
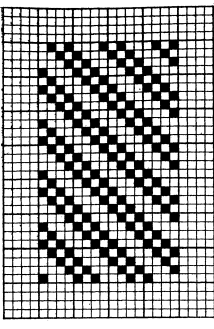

Fig. 167.

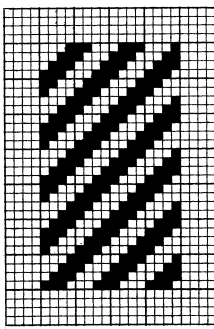

Fig. 172.

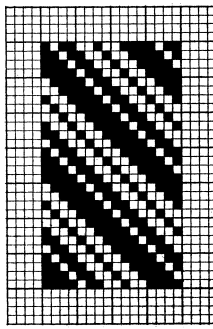

Fig. 177.

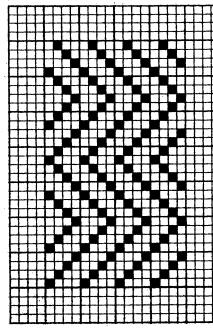

Fig. 182.

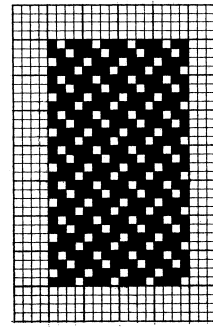

Fig. 166.

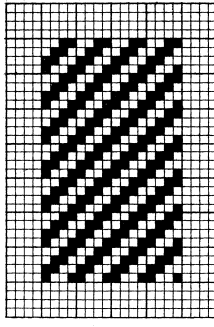

Fig. 171.

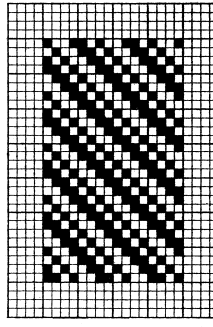

Fig. 176.

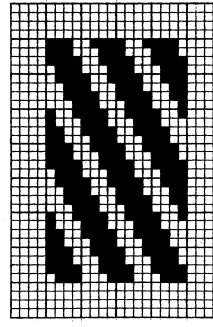

Fig. 181.

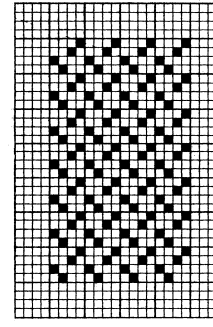

Fig. 165.

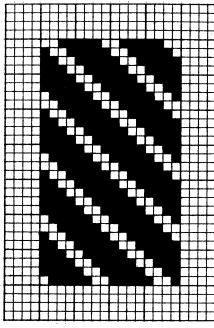

Fig. 170.

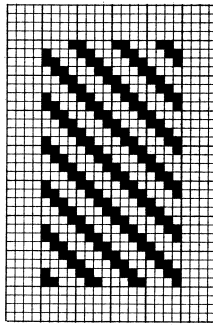

Fig. 175.

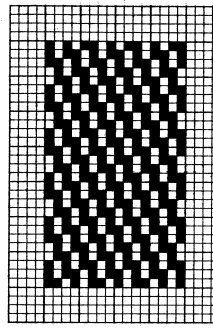

Fig. 180.

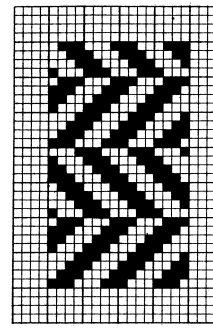

Fig. 164.

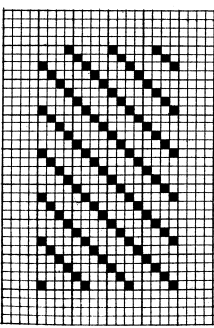

Fig. 169.

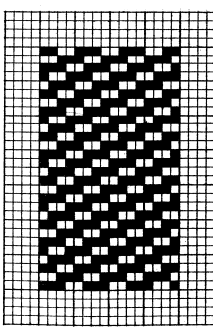

Fig. 174.

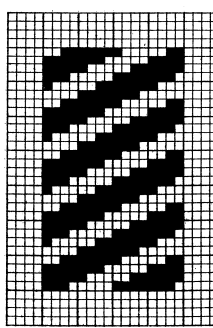
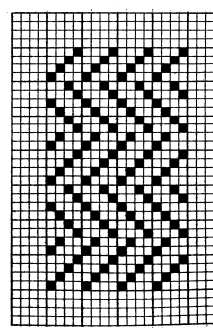

Fig. 179.



TAF. 14.

Fig. 184-198.

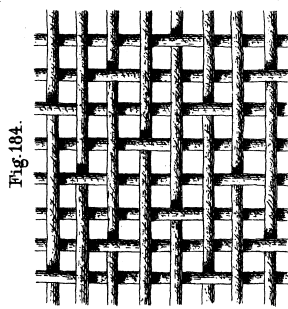

Fig. 184.

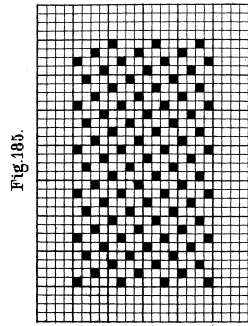

Fig. 185.

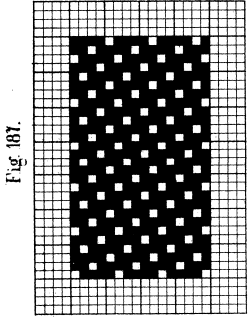

Fig. 187.

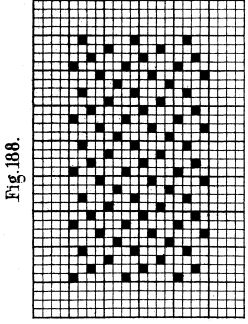

Fig. 188.

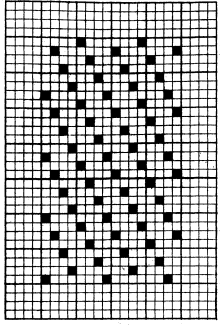

Fig. 189.

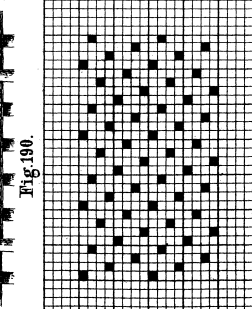

Fig. 190.

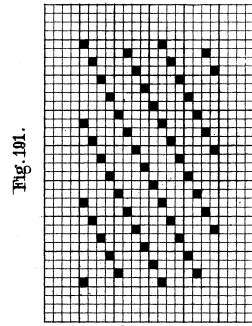

Fig. 191.

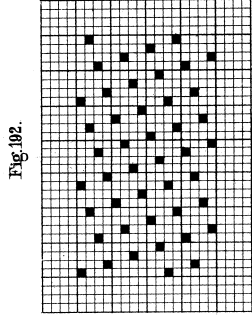

Fig. 192.

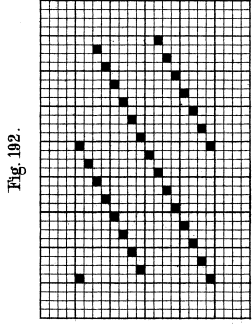

Fig. 193.

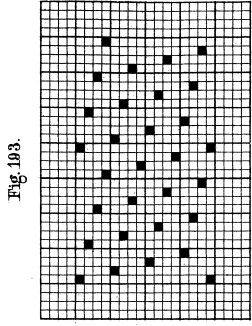

Fig. 193.

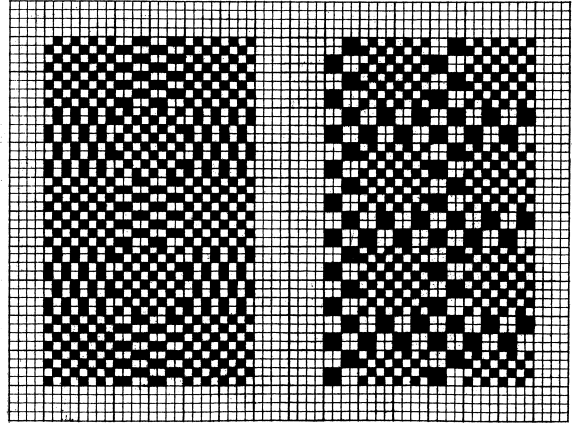

Fig. 194.

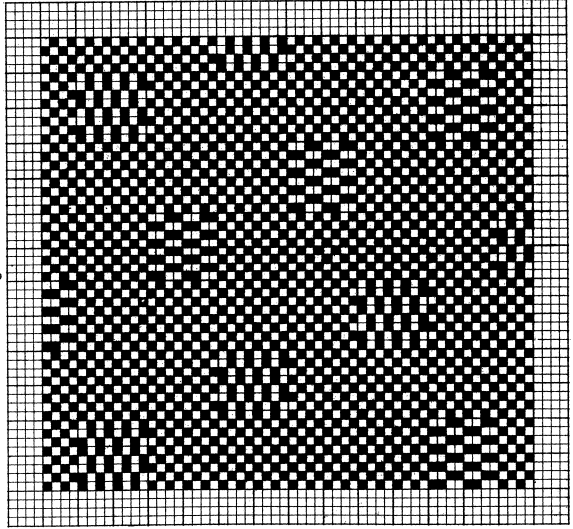

Fig. 196.

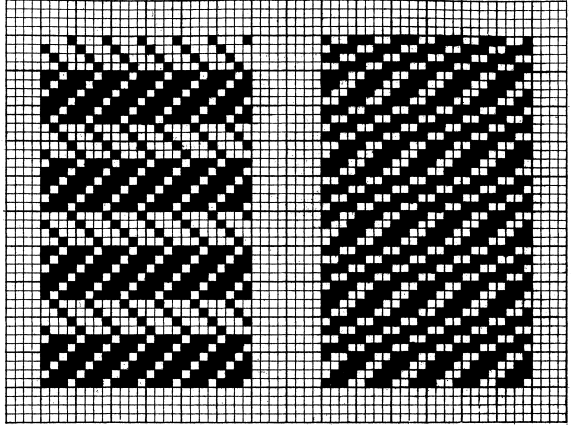

Fig. 197.

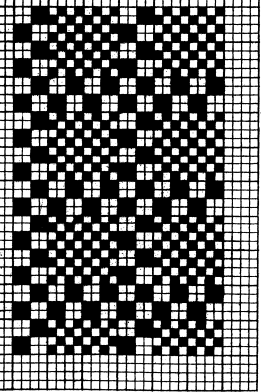

Fig. 195.

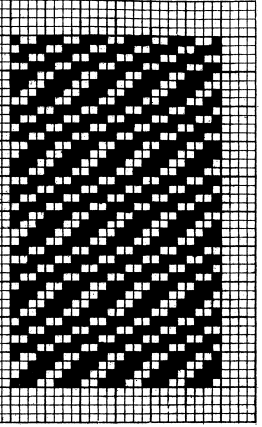

Fig. 198.

TAF. 15.

Fig. 199-210.

Fig. 199.

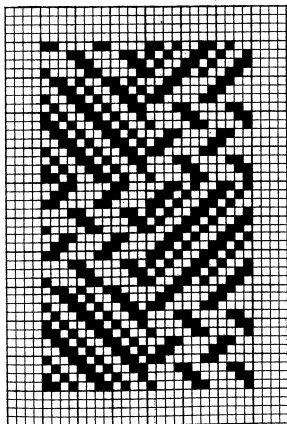

Fig. 200.

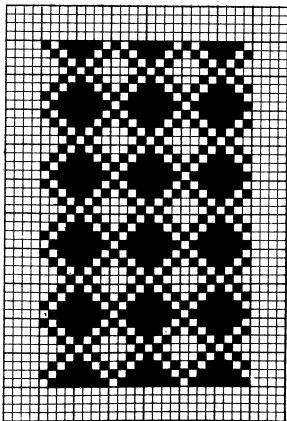

Fig. 201.

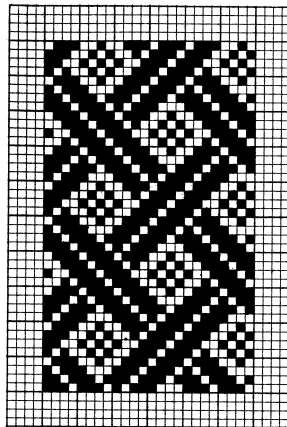

Fig. 202.

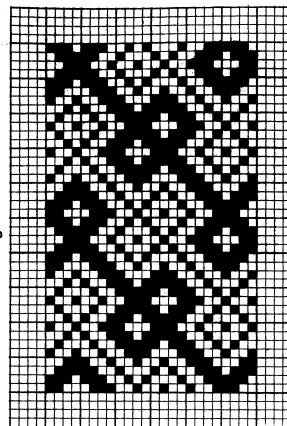

Fig. 203.

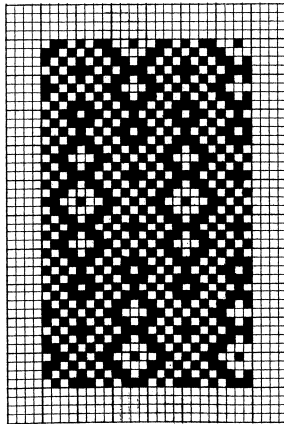

Fig. 204.

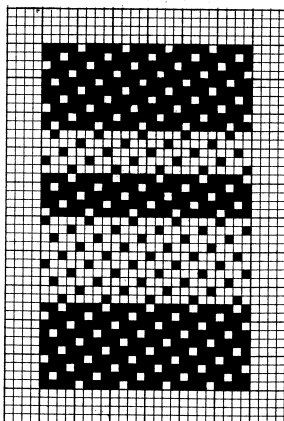

Fig. 205.

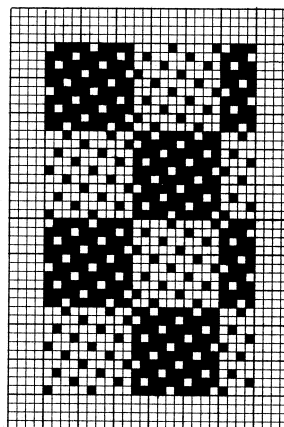

Fig. 206.

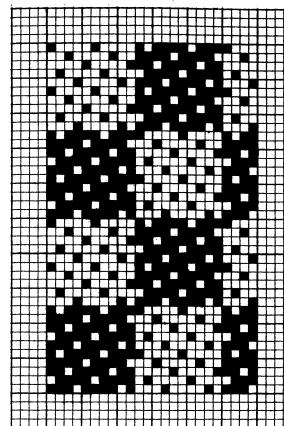

Fig. 207.

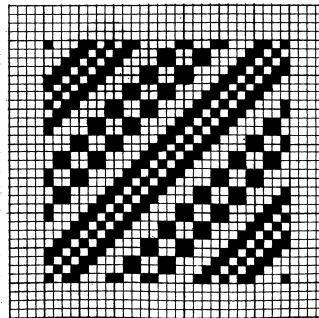

Fig. 208.

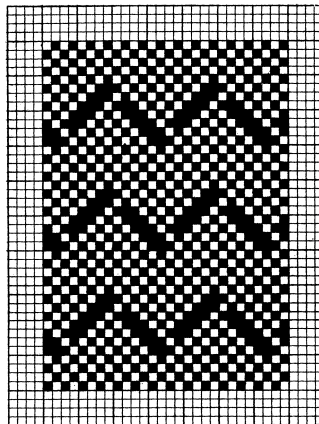

Fig. 209.

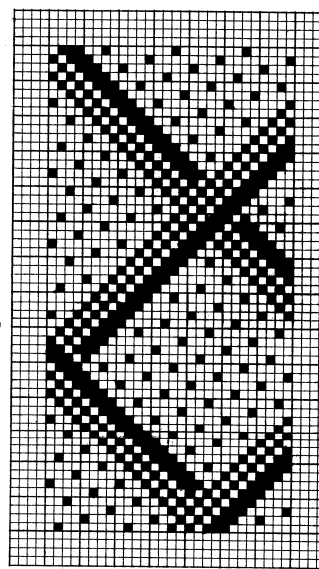
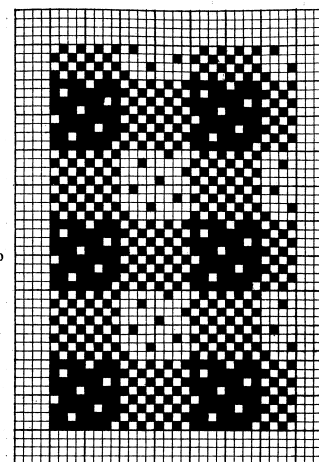

Fig. 210.



TAF. 16.

Fig. 219. Fig. 111-122.

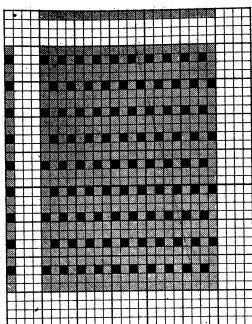

Fig. 220.

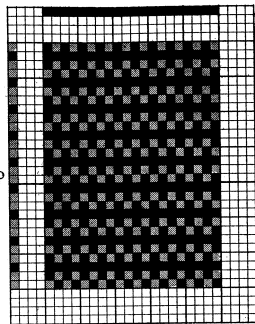

Fig. 221.

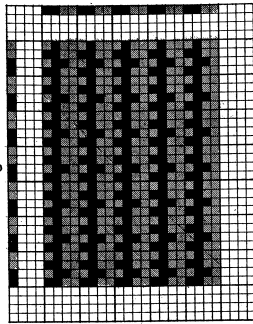

Fig. 222.

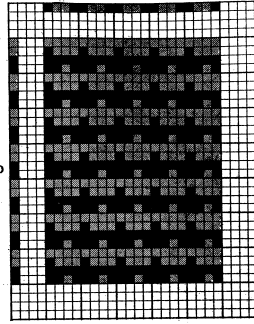

Fig. 212. a b

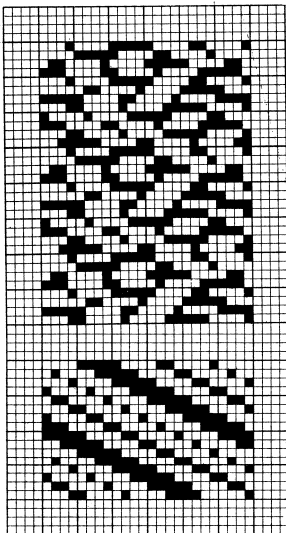

Fig. 214. a b

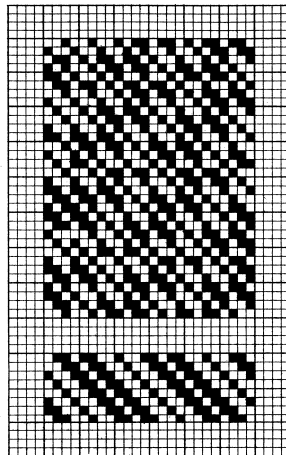

Fig. 218.

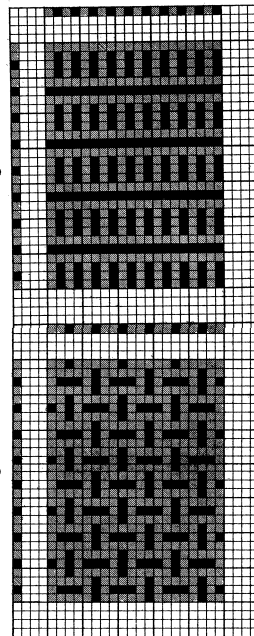

Fig. 211. a b

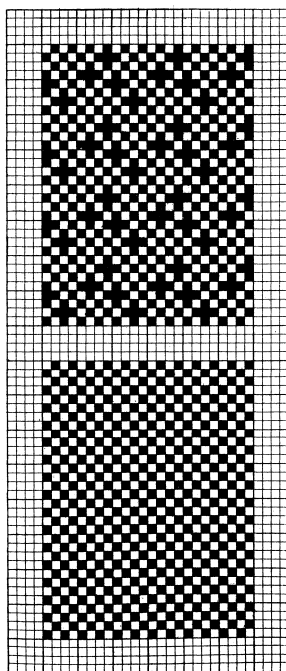

Fig. 213. a b

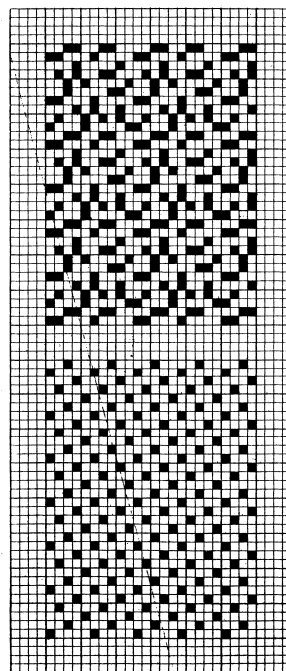

Fig. 216.

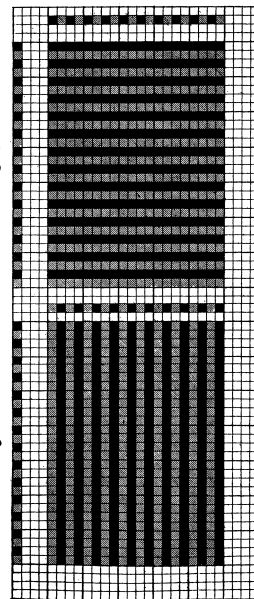

Fig. 217.

Fig. 215.

TAF. 17.
Fig. 223-336.

Fig. 223.

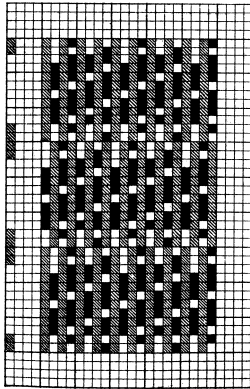

Fig. 224.

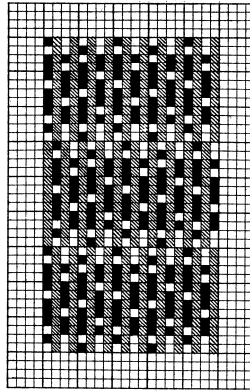

Fig. 225.

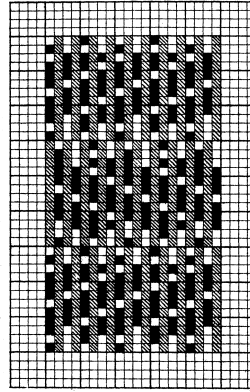

Fig. 226.

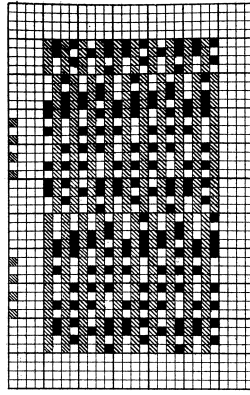

Fig. 227.

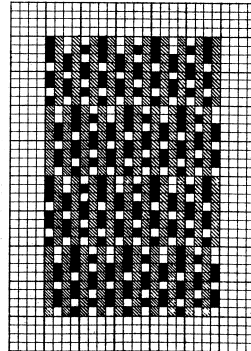

Fig. 228.

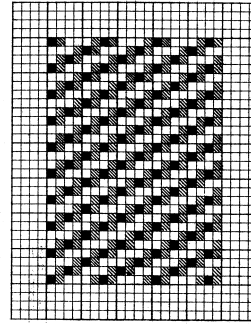

Fig. 229.

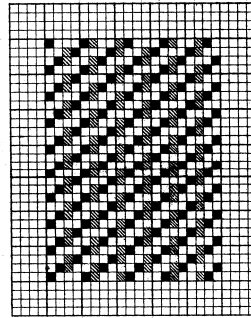

Fig. 230.

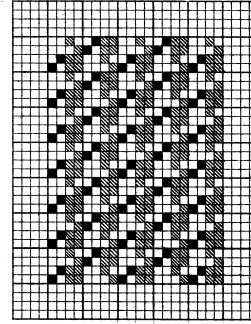

Fig. 231.

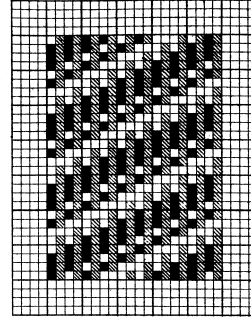

Fig. 232.

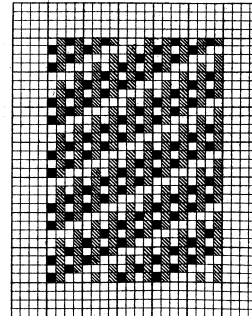

Fig. 233 a.

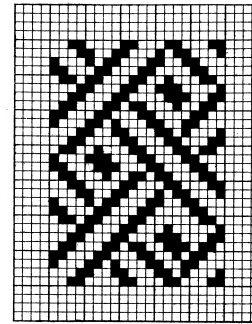

Fig. 233 b.

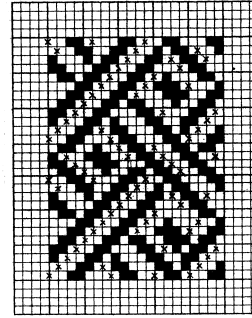

Fig. 233 c.

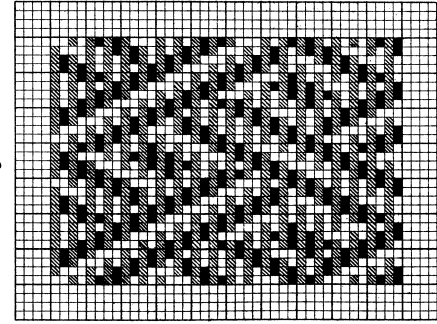

Fig. 236.

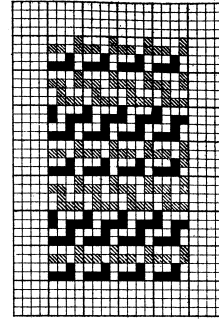

Fig. 234.



Fig. 235.



TAF. 18.
Fig. 237 - 249.

Fig. 237.

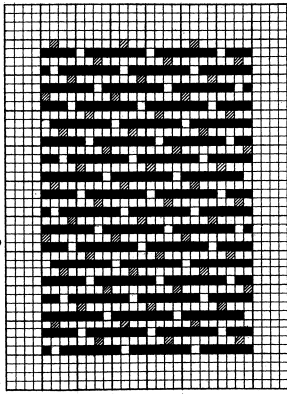

Fig. 238.

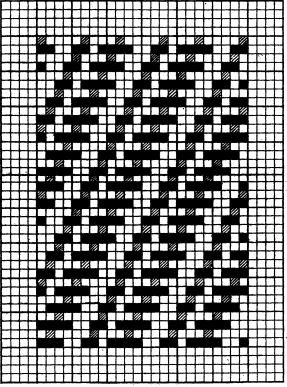
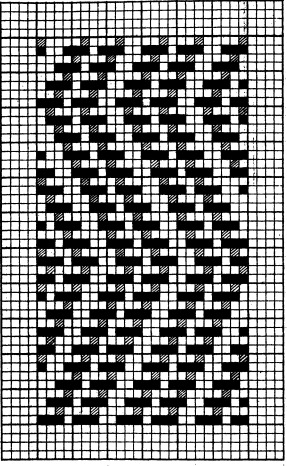

Fig. 239.



a. Fig. 240.

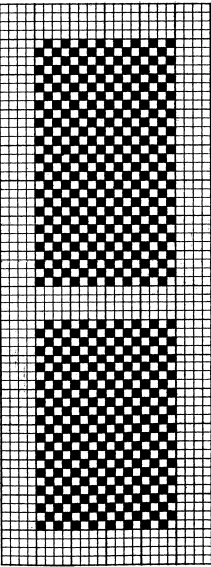

Fig. 241.

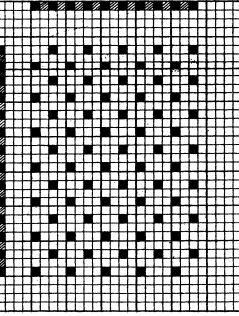

Fig. 242.

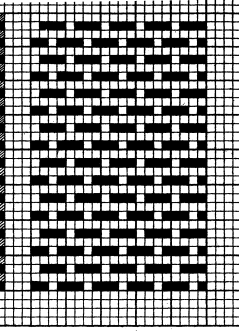

Fig. 243.

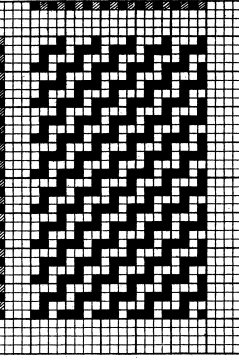

Fig. 244.

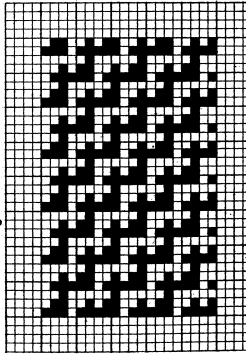

Fig. 245.

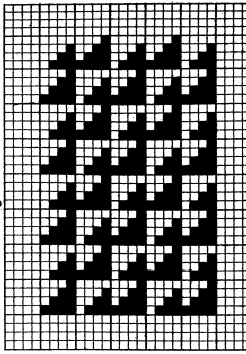

Fig. 246.

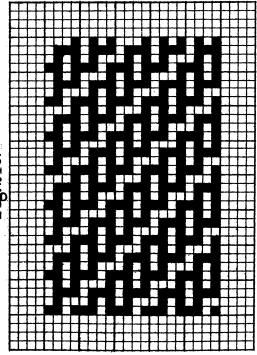

Fig. 247.

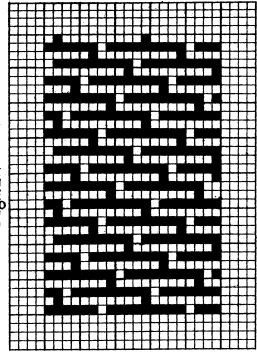

Fig. 249.

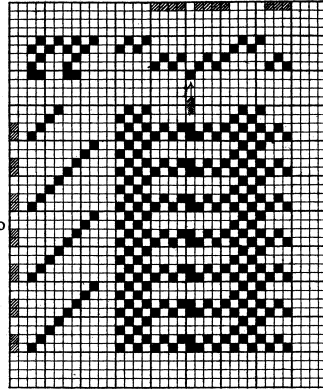
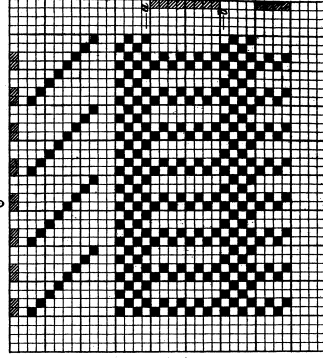

Fig. 248.



TAF. 19.
Fig. 250 - 260.

Fig. 250.

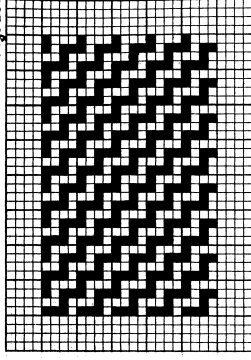

Fig. 251.

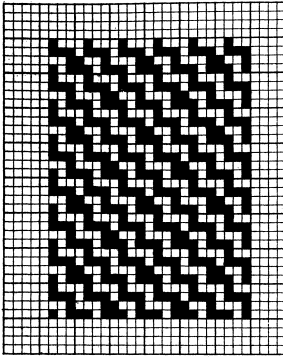

Fig. 252.

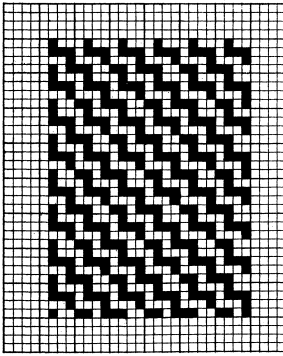

Fig. 253.

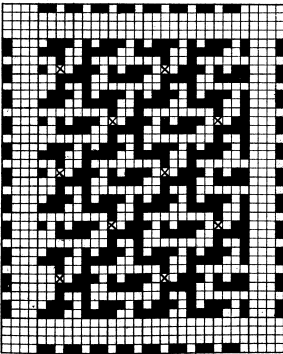

Fig. 260.

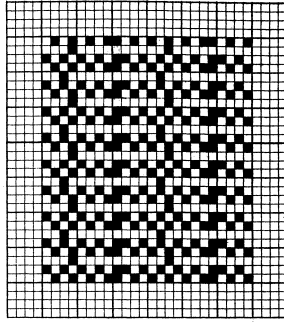

Fig. 255.

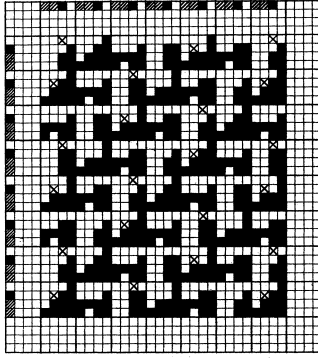

Fig. 259.

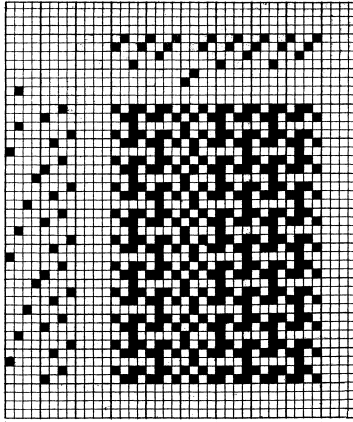

Fig. 254.

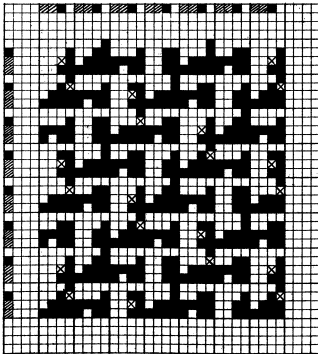

Fig. 256.



Fig. 237.



Fig. 258.



TAF. 20.
Fig. 261-274.

Fig. 261.

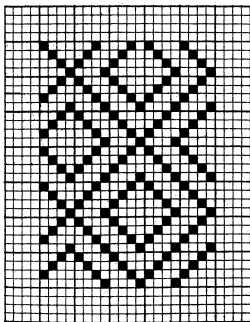

Fig. 263.

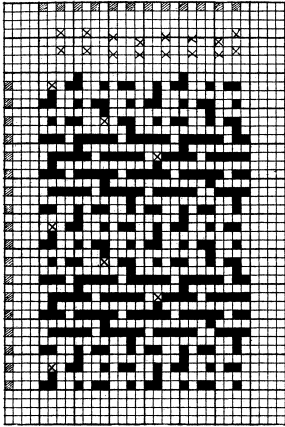

Fig. 267.

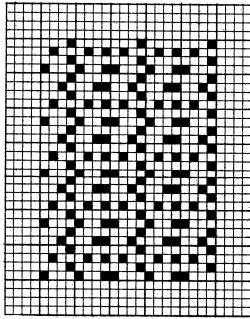

Fig. 269.

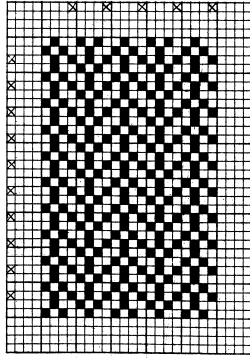

Fig. 270.

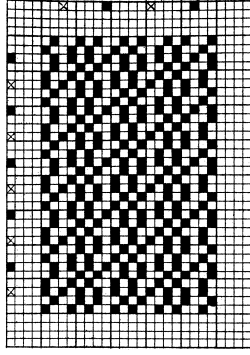

Fig. 264.

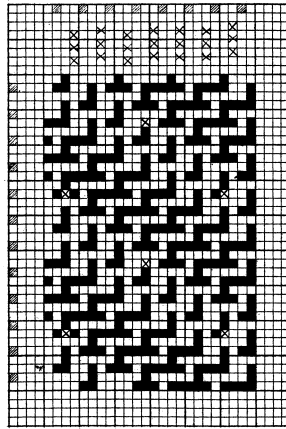

Fig. 262.

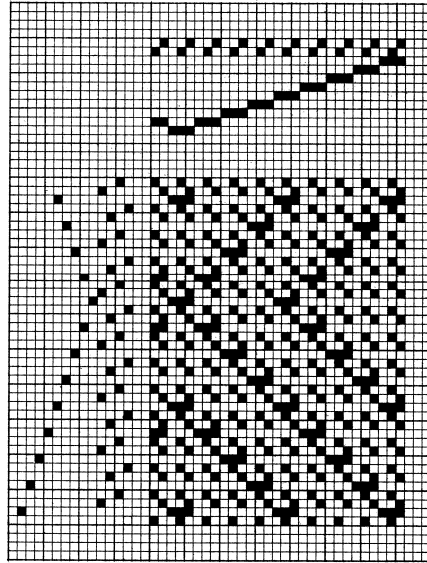

Fig. 268.

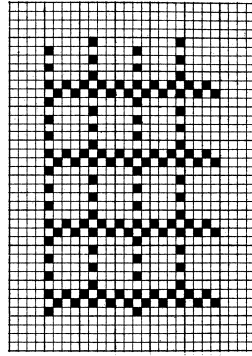

Fig. 274.



Fig. 265.



Fig. 266.



Fig. 271.



Fig. 272.

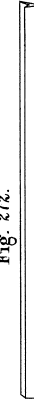

Fig. 273.

