

Encyclopedia Diderot and d'Alembert

Weaving Plates

Part II – Velvet/Velours

Being realized by Philippe DEMOULE

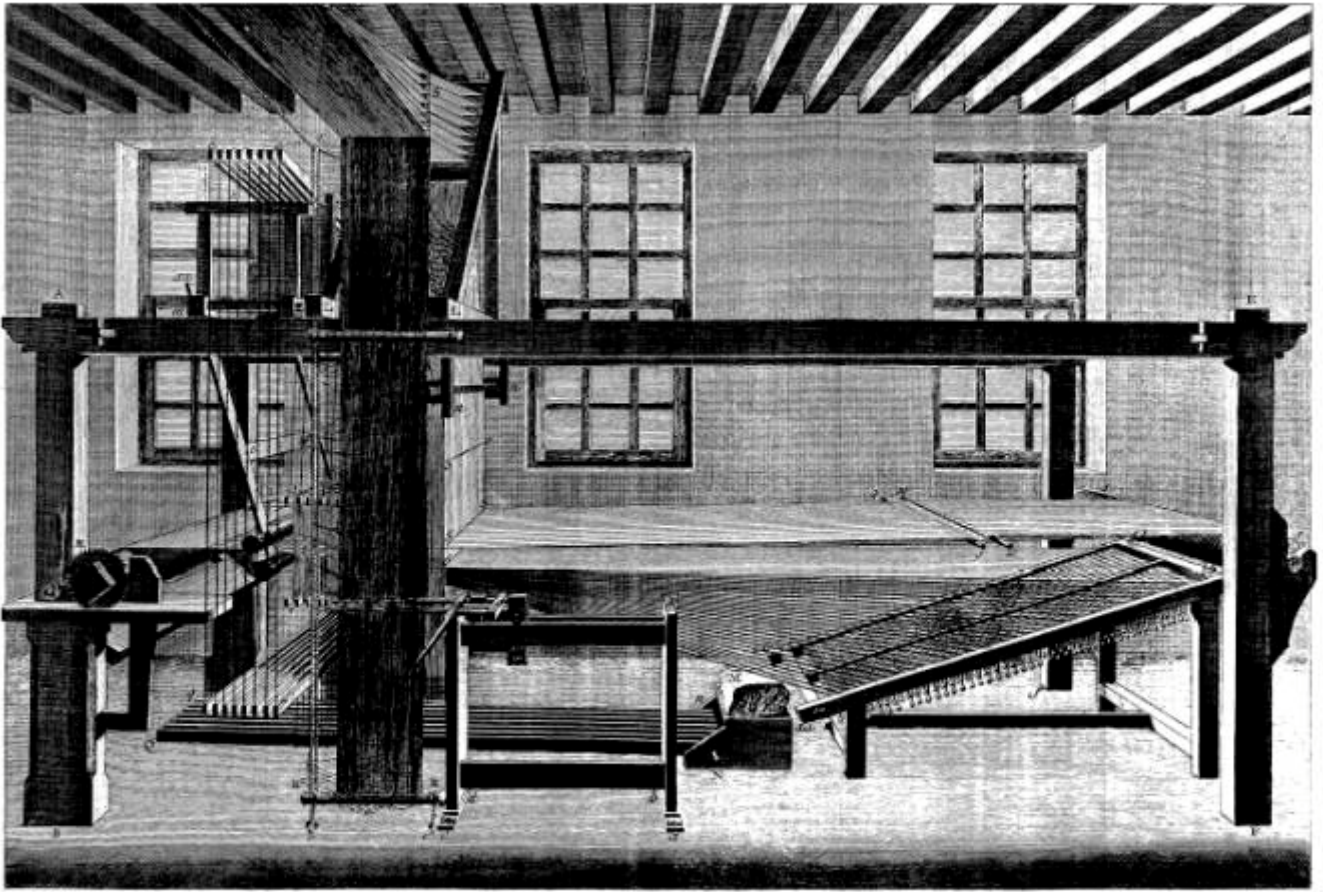

Wagner del.

Gravé par

Soierie, Vélours. Élévation Perspective du Métier pour fabriquer le Vélours Ciséle, vu dans l'instant de la Tire et du Pédage des Fers.

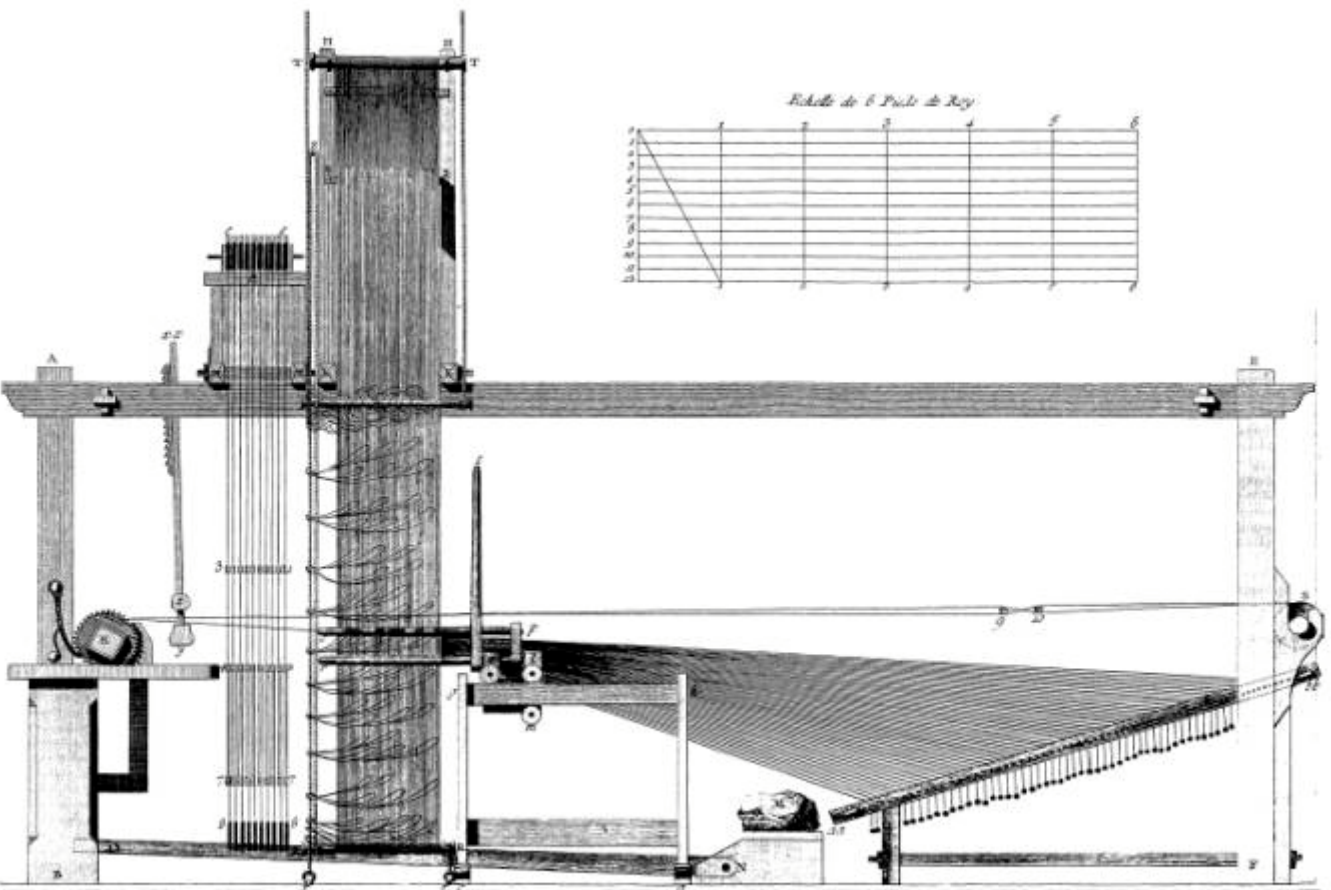

Wagner del.

Gravé par

Soierie, Vélours. Élévation Latérale du Métier pour fabriquer le Vélours Ciséle Vu dans l'instant qui précède celui de la Tire.

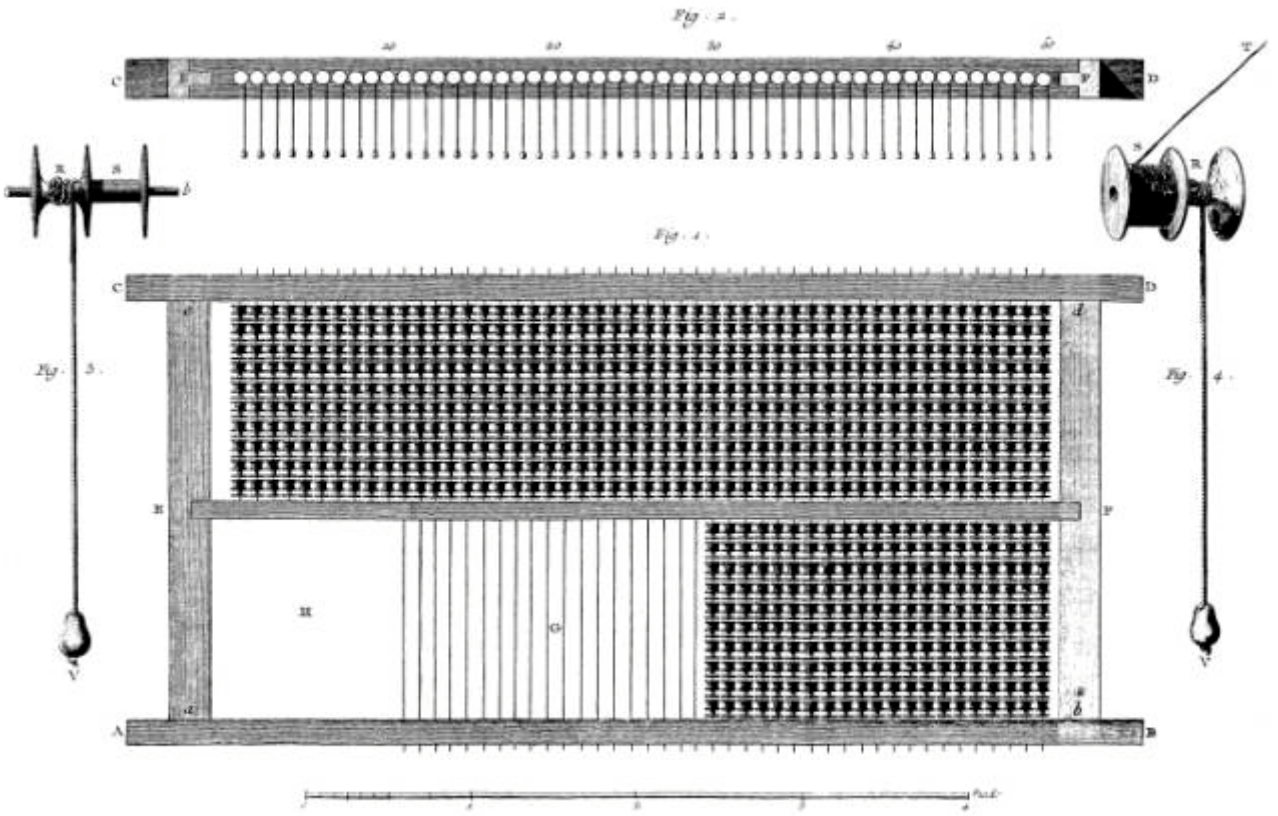

Soierie. Velours Ciselé. Plan de la Caisse et Développement des Espaces.

Soierie. Velours. Développement du Râteau brisé du Mouton à Velours.

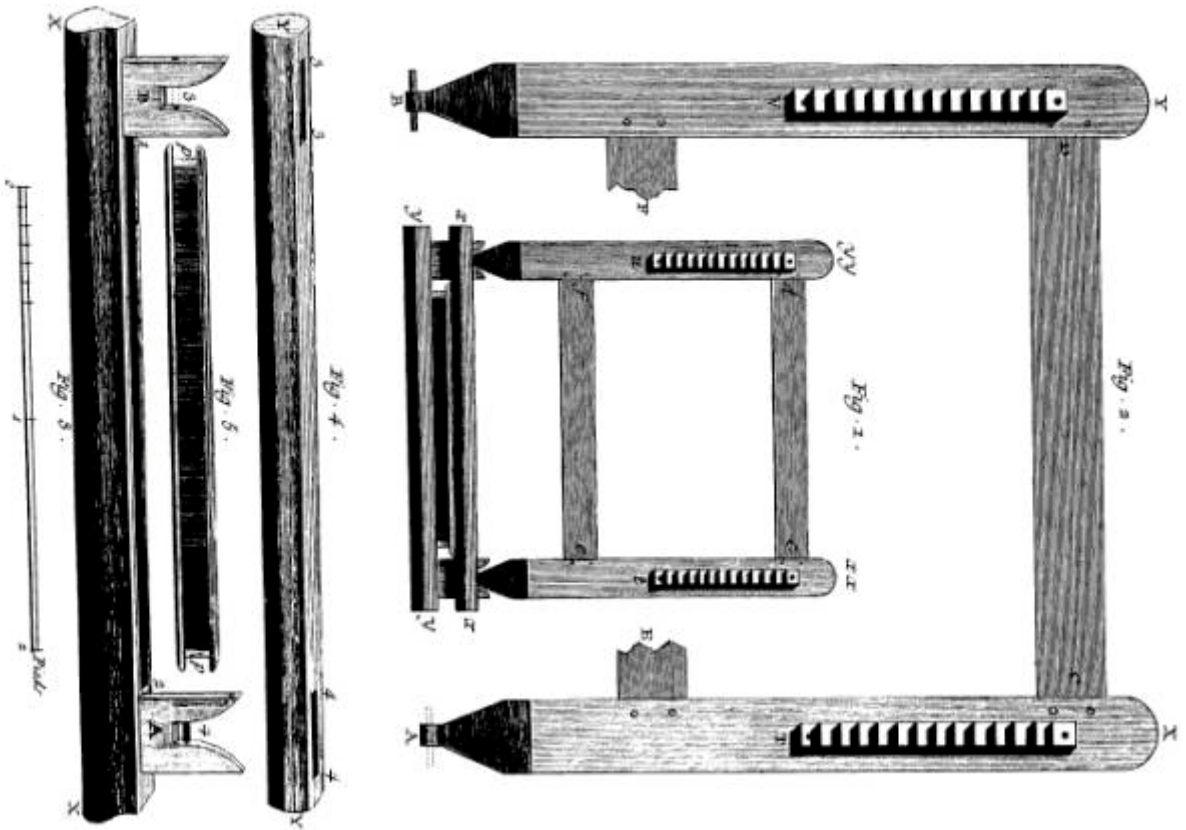

Fig. 2.



Fig. 3.

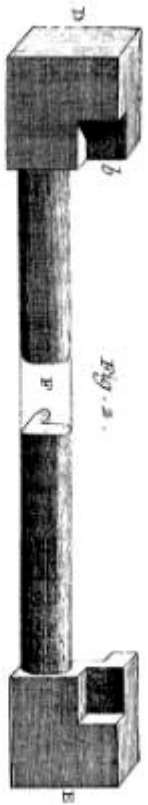

Fig. 4.

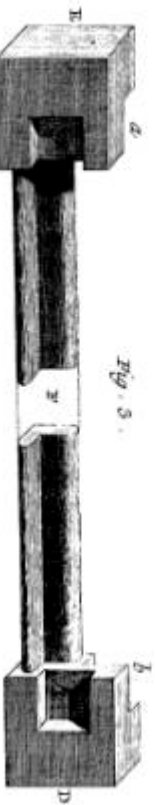

Fig. 5.



Fig. 6.

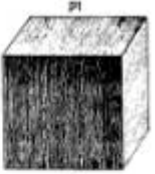

Fig. 7.



Fig. 8.

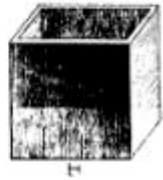

Fig. 9.

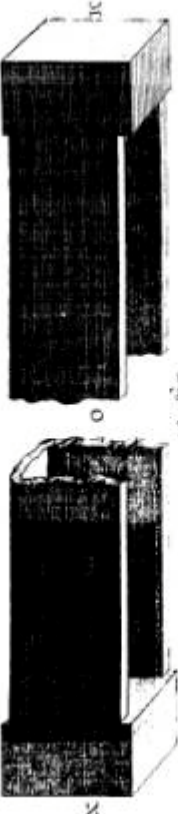

Fig. 10.

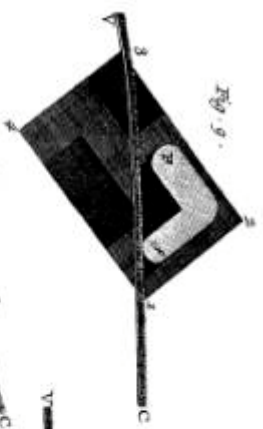

Fig. 11.



Fig. 12.

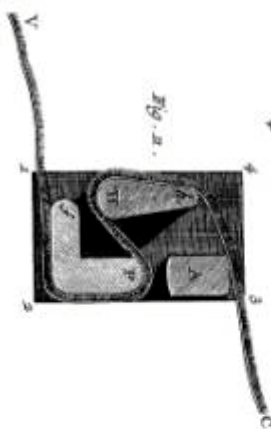

Fig. 13.



Fig. 14.

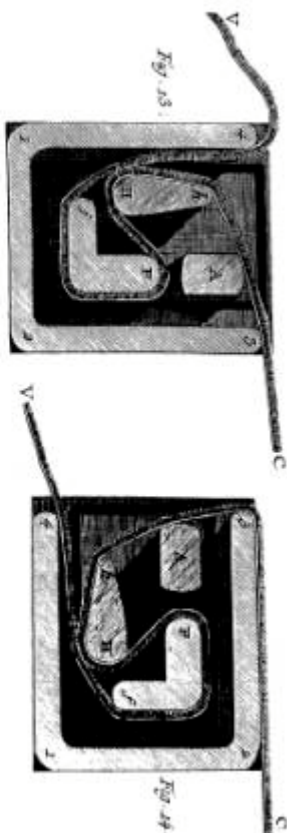

Fig. 15.



Fig. 16.

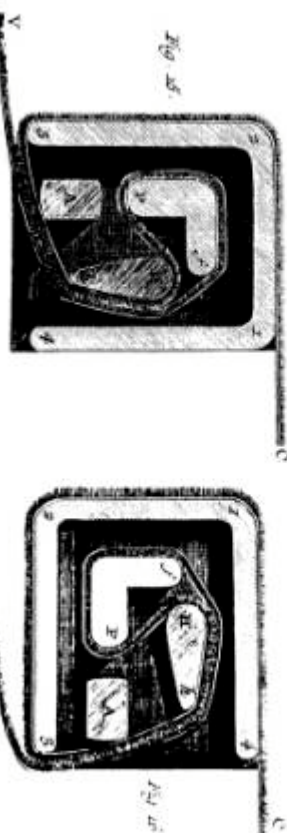
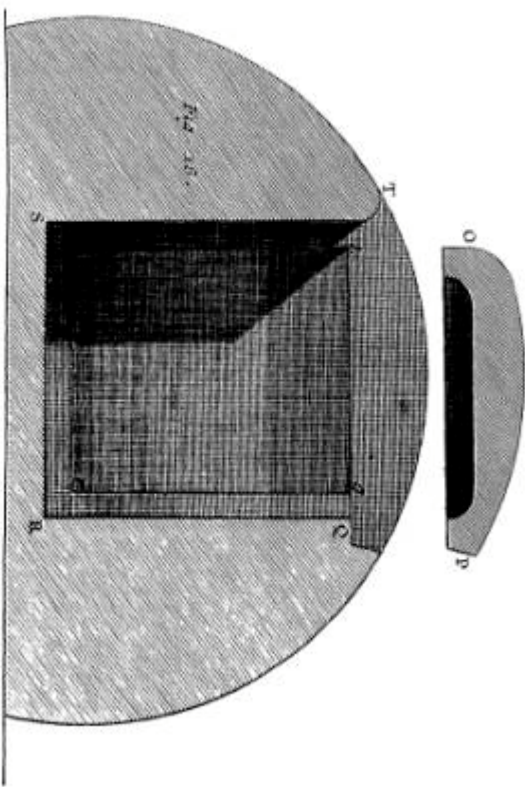
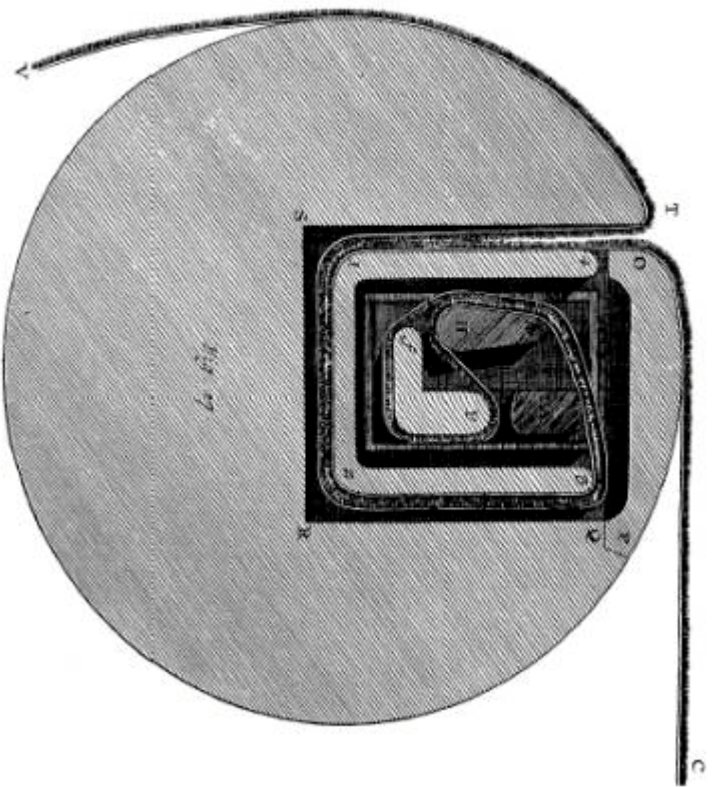

Fig. 17.



Soierie, Tisseurs. Conduccion de l'Arrière.

Soierie, Tisseurs. Maniere d'Entourer le Tisseur.



Soierie, Telleur. Suite de la maniere d'arranger le Telleur.

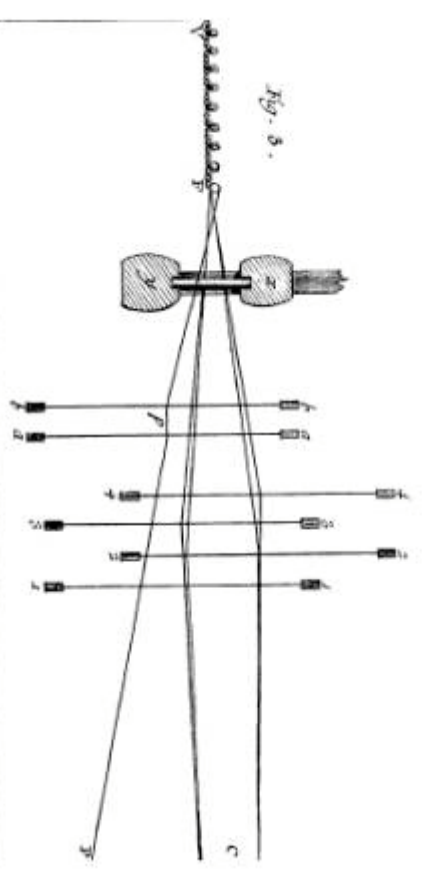
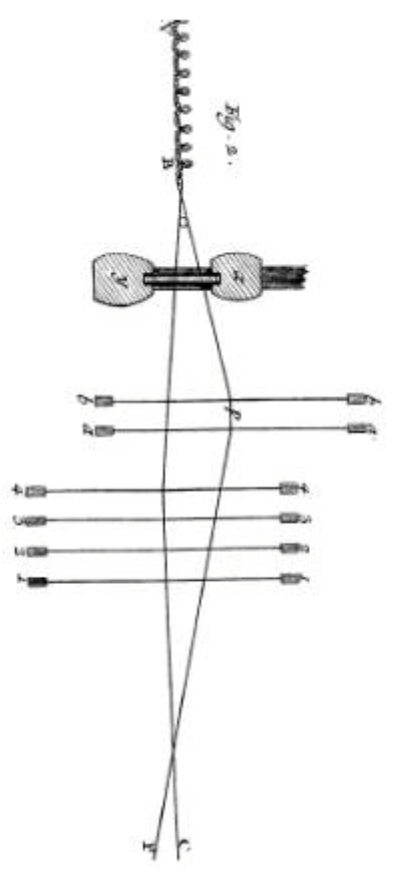
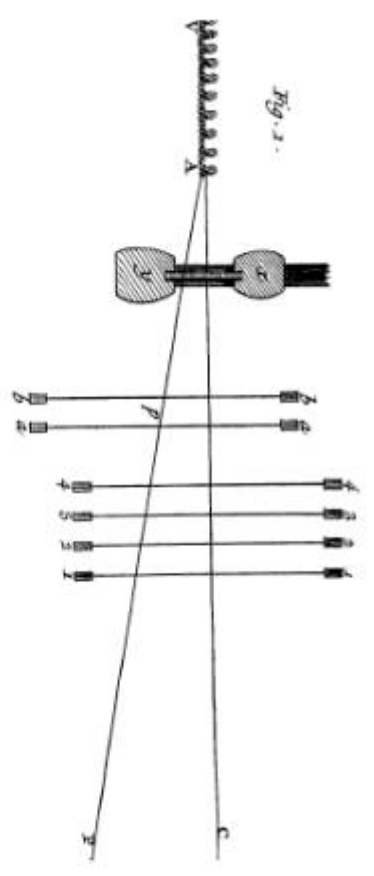

Soierie, Telleur. (1)
 1^{re} Les Laines en repos, 2^e Passage du Fer, 3^e premier Coup de Navette.

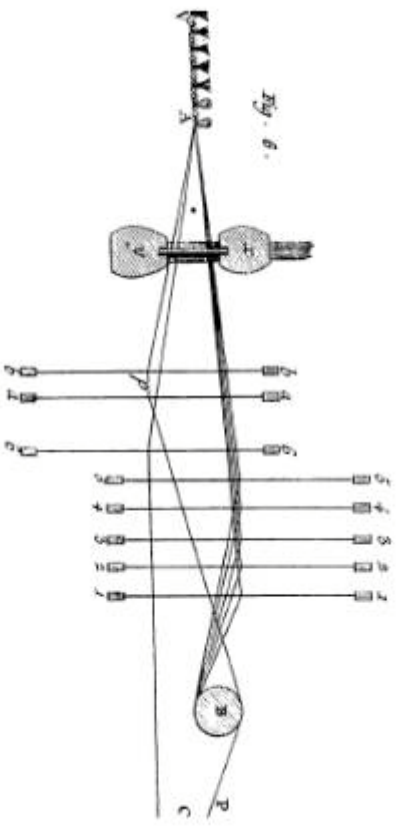
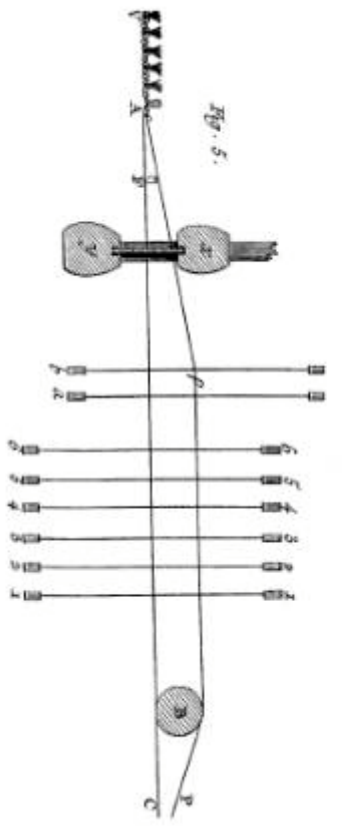
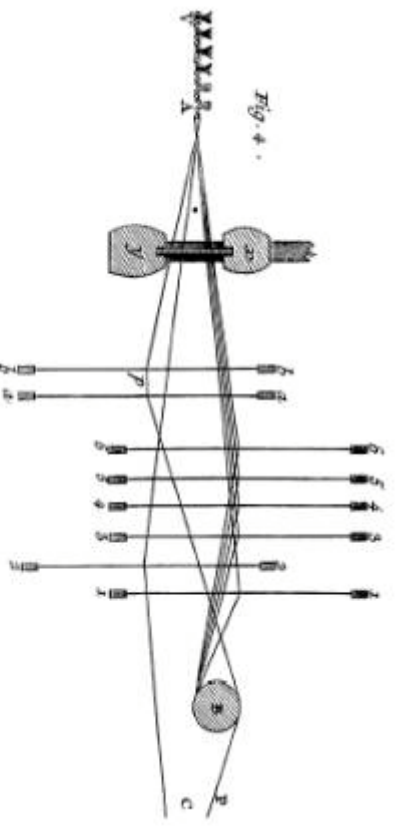
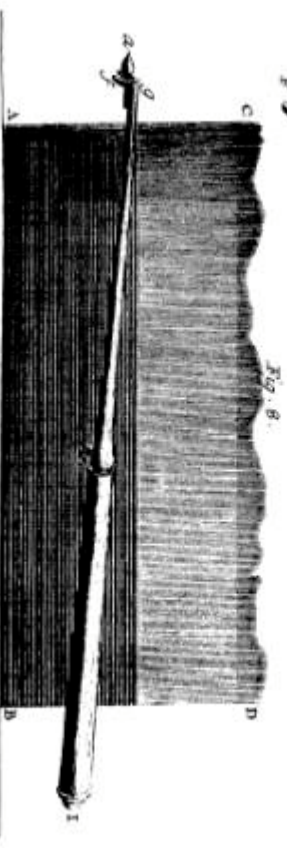
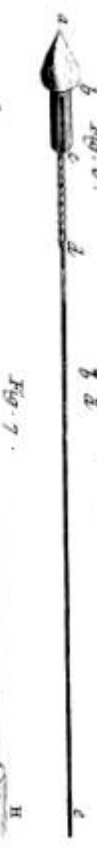
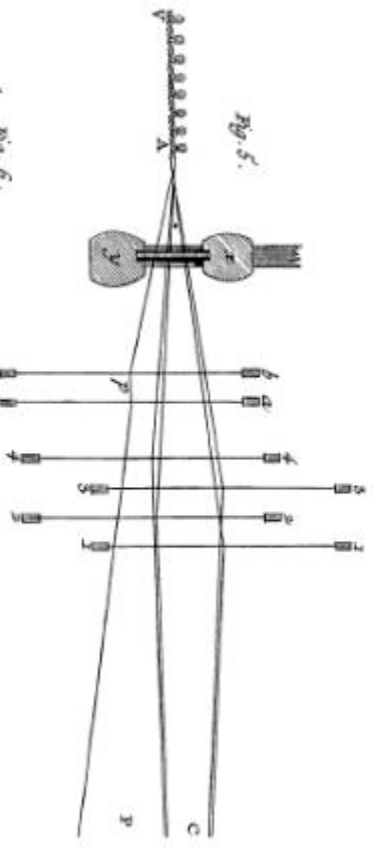
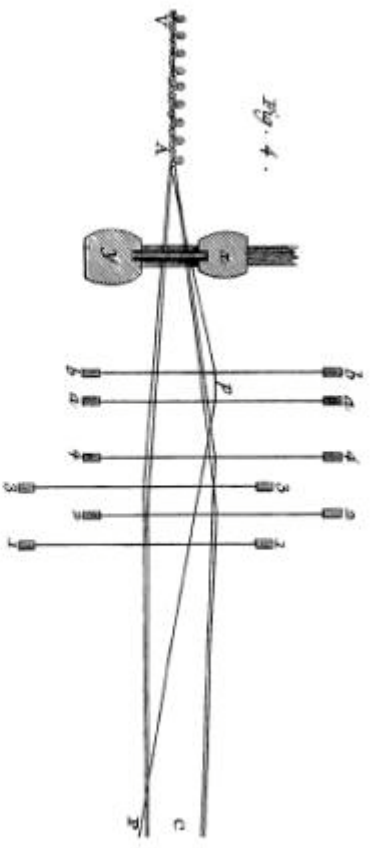

Soierie, Velours Tricé. 4^e second Coup de Navette.
5^e troisième Coup de Navette. Rer de Tricé garni de 3 Lours Redours. 299

Soierie, Velours Coupé.
4^e troisième Coup de Navette, 5^e Passage du Rer, 6^e quatrième Coup de Navette.

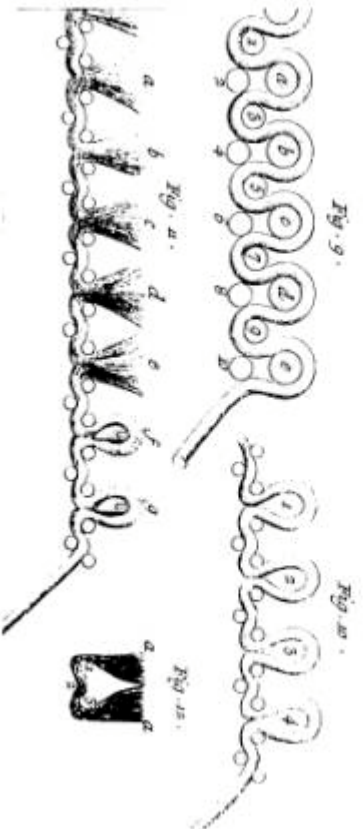
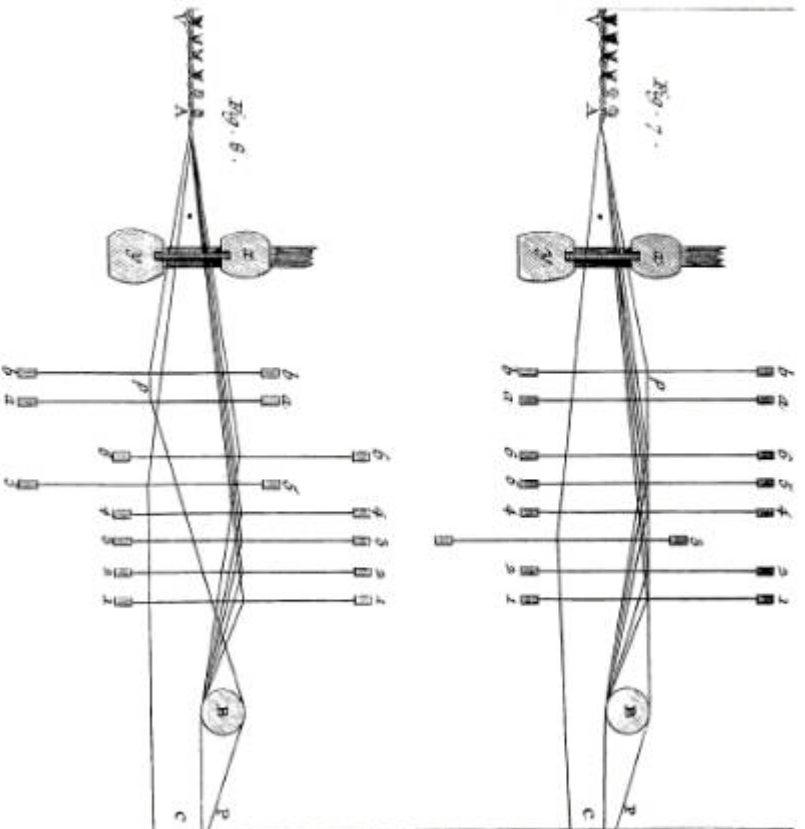

*Soierie, Velours Coupé. 7^e (usuelle Coup de ?)
Nouvelle 5^e (usuelle Coup de Naxette Profil du Velours Frié et du Liège sur l'au au Microscop)*

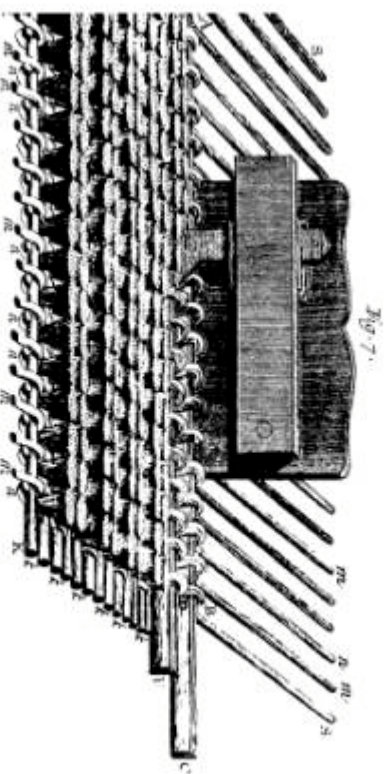
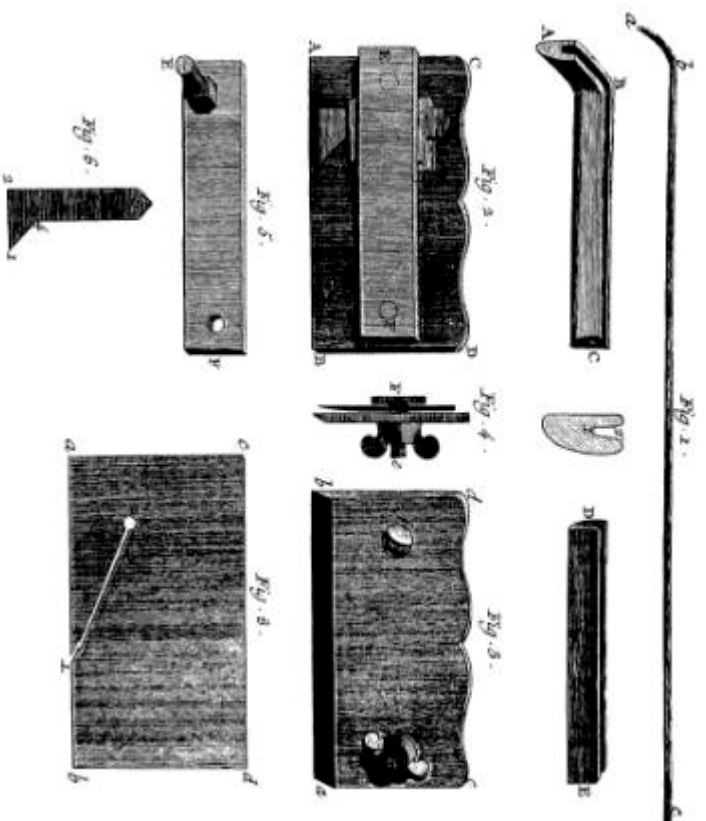

*Soierie, Velours Coupé. For de Coupé, Rive 2, m m m
Tulle-elle: l'auge du Rivot et Velours Coupé en au au Microscop et au au Microscop ?*

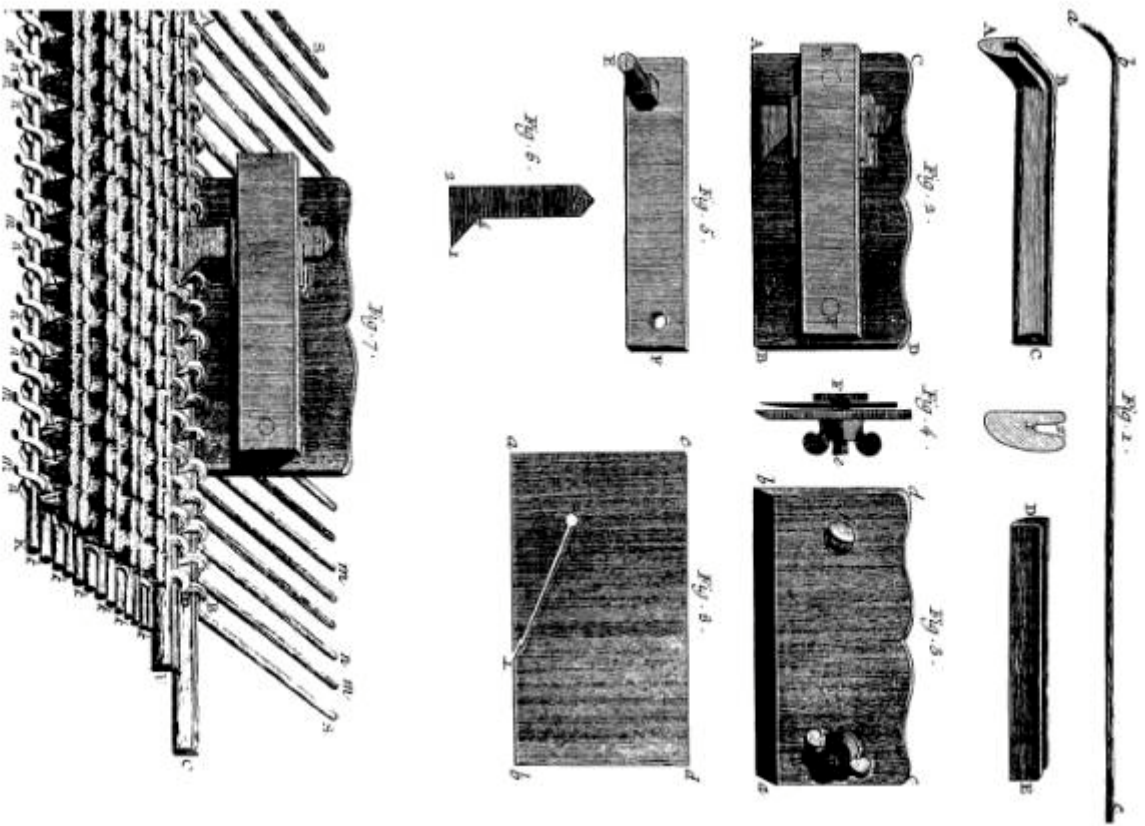

*Soierie, Têlours Coupe', Tors de Coupe', Rabotez, m m m
Tâcherolle, Tâge du Rabot et Têlours Coupe' vu au Harroage et en perspective ?.*

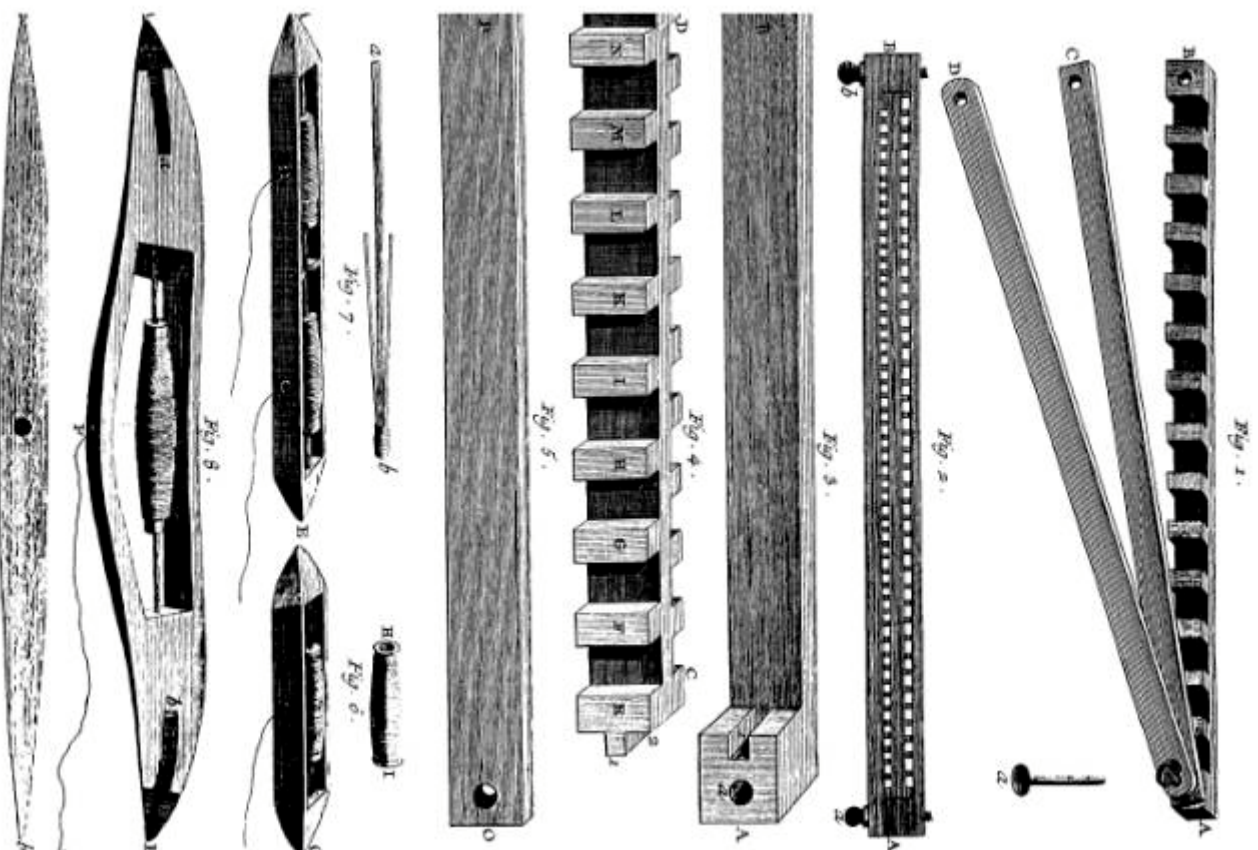

Soierie, Escalier, Trepelous, Vantelle 8c.

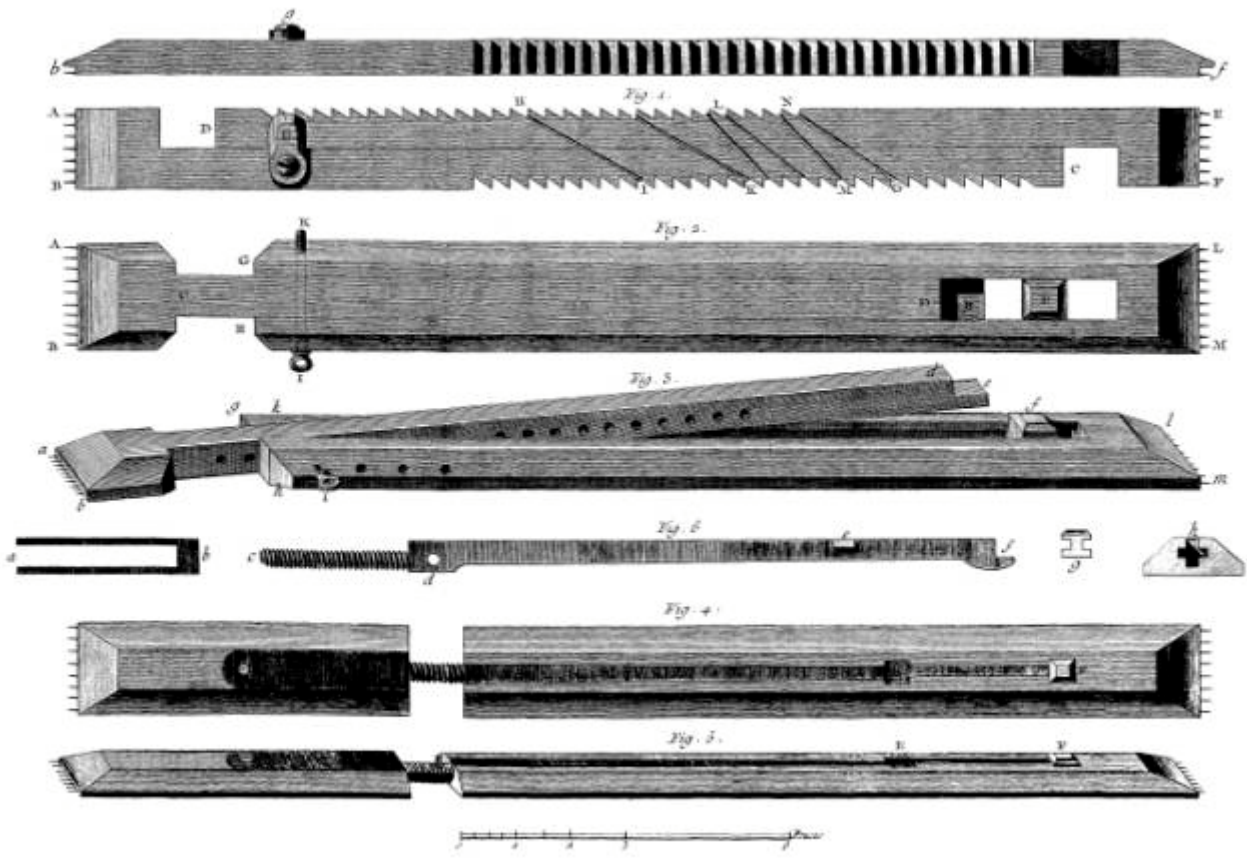

Soierie, Tempia de differantas sortes, Tempia à Corde, Tempia à Bouton et Tempia à Vis.

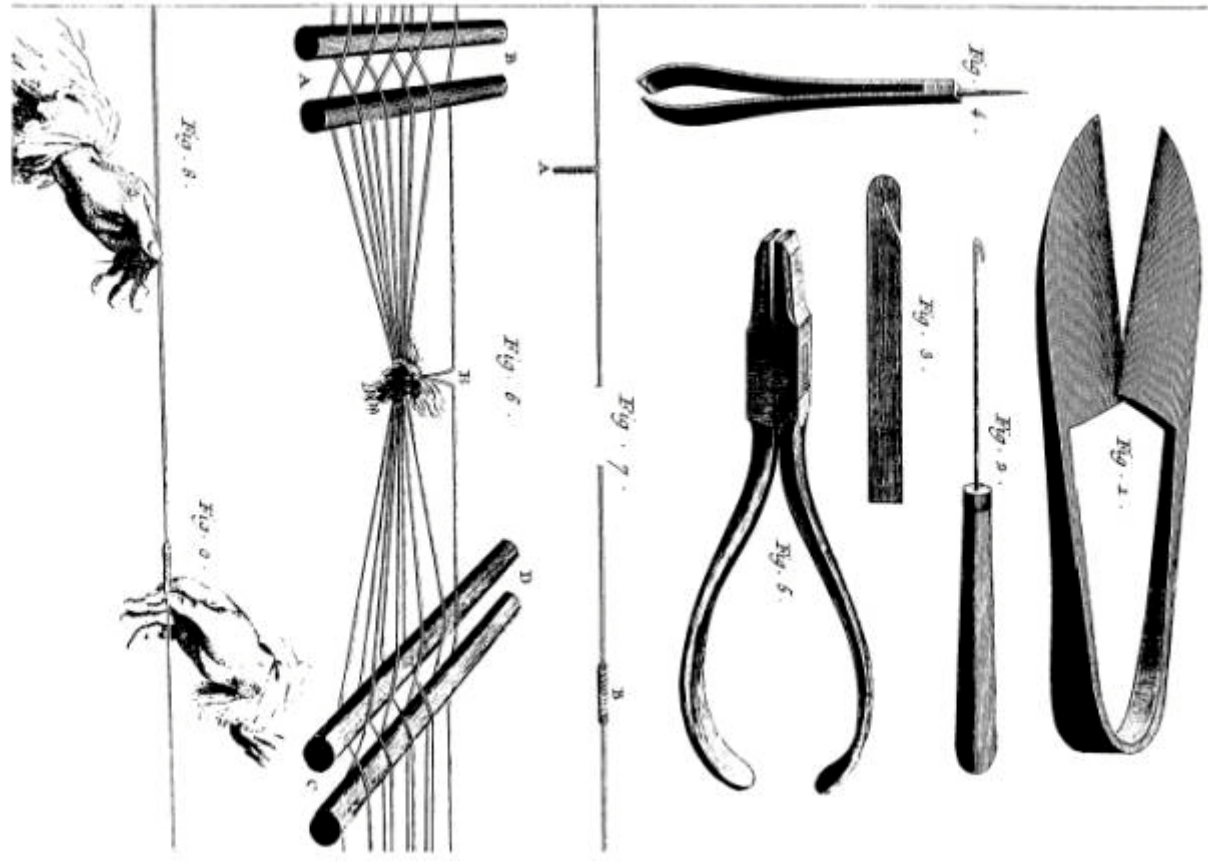

Soierie, Différens Outils et Manière de Tenir une nouvelle Chaine.