

# HOW TO WEAVE on the **INRIDE LOOM**

by  
Mary M. Atwater

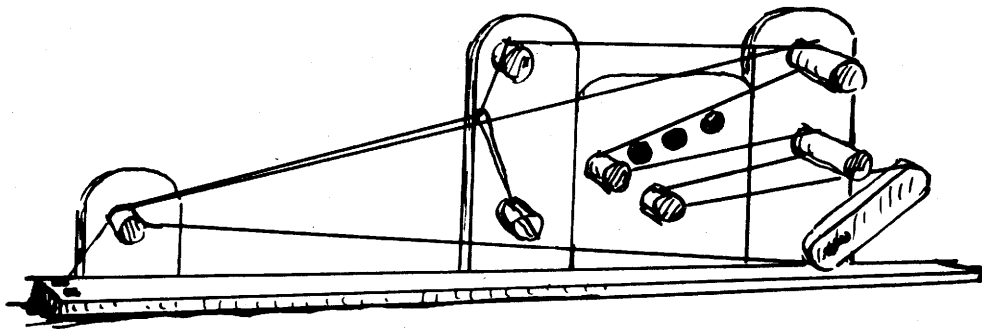

*Handwritten signature or initials, possibly 'M.A.' with a flourish below.*

A Group of Inkle's.

1

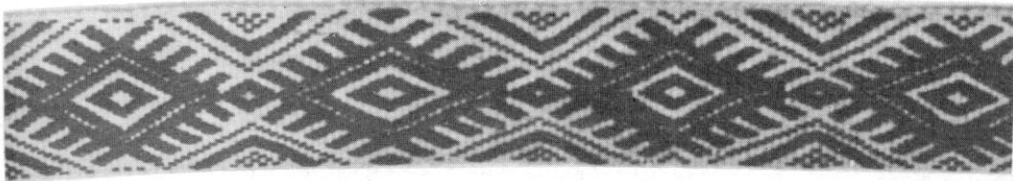

2

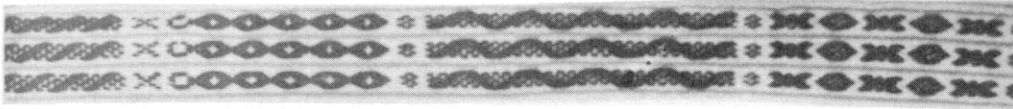

3

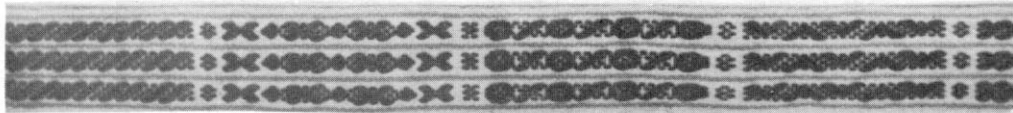

4

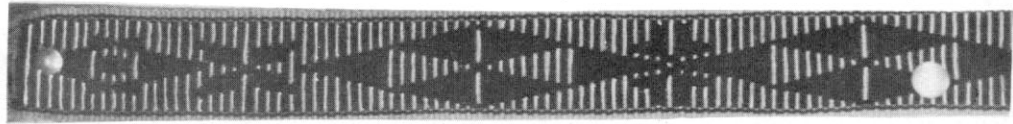

5

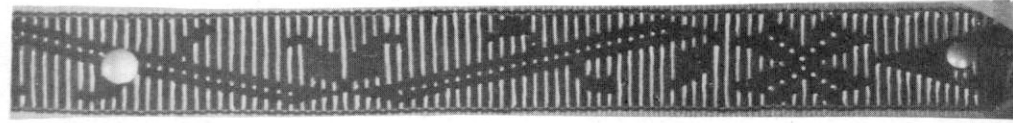

6

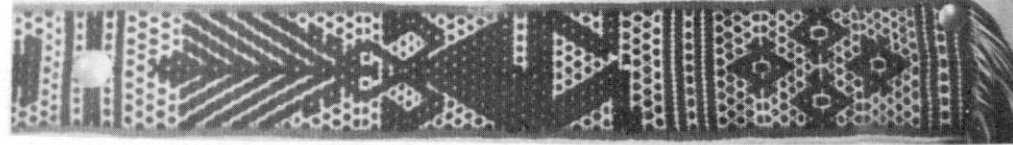

7

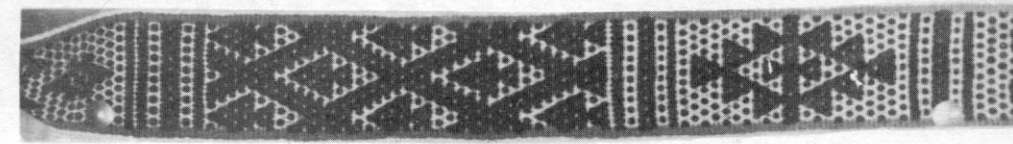

1. Central European pattern, draft (b), Diagram No. Four
- 2 and 3. Mexican pattern, draft (e), Diagram No. Four
- 4 and 5. Bolivian patterns, draft (a) Diagram No. Five
- 6 Mexican figures, draft (b), Diagram No. Five
7. Navajo " " " " " "

# HOW TO WEAVE on the

## INKLE LOOM

by  
Mary M. Atwater

The Shuttle-Craft  
Guild  
Basin, Montana

(Copyright 1941, Mary M. Atwater)

According to the dictionary an "inkle" is a narrow band or tape, and it follows logically enough that an "inkle loom" is a loom designed for the weaving of narrow fabrics. In the old day father's "galluses" and the family draw-strings and garters were woven on such a loom, shown below on the sketch at (a). Recently a modified "table" version of the ancient inkle loom -- shown below at (b) -- has been designed and is being built by Mr. E.E. Gilmore, 1200 West Harding Way, Stockton, California. Both looms are operated in the same manner, and the directions given herewith apply to either.

Diagram No. One

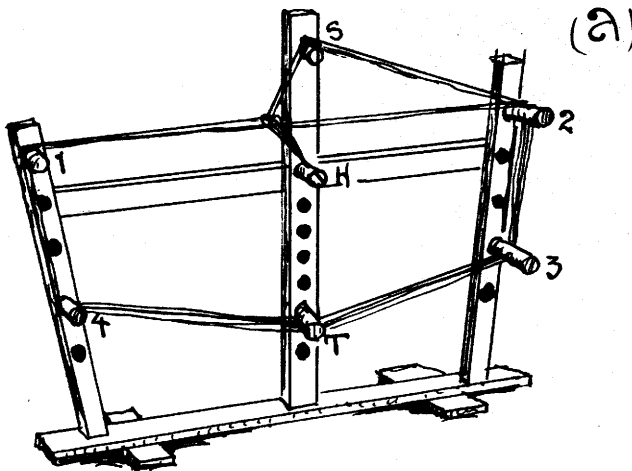

Old English Inkle Loom

1, 2, 3, 4, measuring pegs

H, heddle peg

S, stretcher "

T, tension

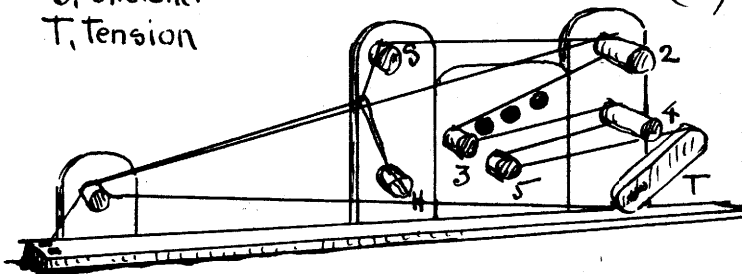

New American Inkle Loom

Though woven garters are now as extinct as the fabulous dodo-bird, we of today have many uses for narrow fabrics, -- as belts and girdles, hat-bands, wrist-watch ribbons, bag-handles, pack-straps, sandal-straps, as tape for the finishing of upholstery, etc., etc.. For the weaving of such things the little inkle loom is a useful and interesting bit of textile equipment, and the art of weaving on such a loom is a delightful bit of textile lore. One may "inkle" happily during conversational interludes, or while listening to the radio, on the porch, in camp, even during long trips by train or boat.

At first glance the inkle loom appears to be simply a small warping frame, and in fact that is what it is -- a warping frame with a simple shedding attachment that permits weaving off the warp directly from the frame. The pegs numbered 1, 2, 3, 4, and 5 on the sketches are the pegs of the warping frame over which the warp is measured. Warps of various lengths may be made by setting the pegs as desired. The peg marked

"H" carries the heddles -- loops of linen, tied through a slot cut lengthwise through the peg. The peg marked "S" is a spreader, and "T" is used to control the tension.

To set up the loom, attach the end of the warp-material to peg No.1, using a loop-knot that can readily be untied. Or, on the New American loom, slip the end of the thread under one of the metal clips set in the base under pag No. 1. Carry the thread over peg No.2, and around the other numbered pegs as shown on the diagram, back to peg No. 1. This warps the first thread. Take the second thread through one of the heddles, over the stretcher peg, then over peg No. 2, and from there around the other numbered pegs in the same manner as before, back to peg No. 1. Continue in this manner, alternating an "open" and a "heddle" thread, till the warp is complete. Finally untie the first thread from the peg, or slip it out from under the catch, and tie the ends of the first and last threads together. Care, of course, must be exercised to warp all threads at an equal tension.

To operate the loom insert the right hand between the two parts of the warp between the heddles and peg No. 2. Press down. This opens a shed in front of the heddles for the passage of the shuttle. To make the second shed, lift the lower part of the warp, between the heddles and peg No. 2. Diagram No. Two below will make this entirely clear.

The loom has no beater, and the weft-threads must be driven together with the shuttle, or worked back with the fingers. A small flat shuttle can be used, but a small Norwegian belt-shuttle, with a knife-edge, is much more efficient. Such a shuttle is ordinarily supplied with the inkle loom.

For the weaving of a plain tabby fabric the above directions are all that are required, but a plain tabby tape is neither very handsome nor particularly useful, so the inkle loom is rarely used in this manner. We want color and patterns in our inkle.

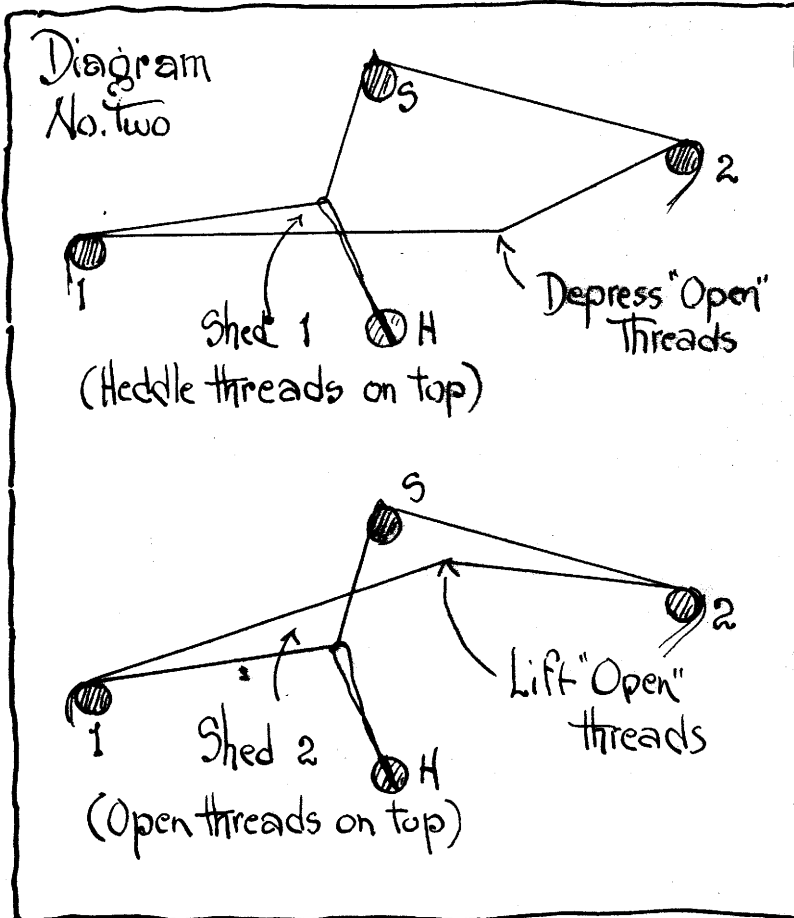

To be sure, very interesting little patterns may be produced in plain weaving by setting the warp close enough to cover the weft, and by warping in two or more colors. Diagram No. Three gives a number of drafts for patterns of this type. The material used may be any of the "perle" cottons, silks, hard-twisted wool or worsted yarns, linens, or any firm -- not fuzzy -- material. The weft should be coarser than the warp and should be in the color of the edge threads of the warp, as it shows nowhere except along the edges.

The pattern effect is entirely in the warp, and the weft should be drawn tight enough to bring the warp close together. Care must be exercised to keep the width of the band even, and for a firm and serviceable fabric the weft should be driven together as close

as possible. As the take-up is altogether in the warp, the warp should not be stretched too tight, and as the weaving progresses the tension should be released from time to time.

In reading the drafts, read the upper row -- marked "H" -- as threads taken through heddles, and the lower row, marked "O", as threads warped "open" over the pegs. The various hatchings indicate the changes of color. It is advisable to tie off each set of colored threads as they are warped instead of carrying a continuous thread for the full width of the band.

The narrow patterns shown on Diagram No. Three may be used for bag-handles, and -- when done in fine silks -- for wrist-watch ribbons. The wider patterns are excellent for belts and girdles. Threading (f) is the pattern of a piece of Navajo belt-weaving, done in hard-twisted wool in natural brown and tan. It is a simple and handsome figure. Pattern (f) is from a Scandinavian piece done in many colors, and is very effective. The sketch gives little idea of this effect. More colors, and different colors, may be used, of course, each color introduced in the manner shown on the draft. This is a good pattern for beginners, as it is showy and amusing, and so simple to weave that a small child can make it.

But though many interesting patterns may be produced in the above manner, the more occult effects are produced by the pick-up method. These pick-up weaves can be -- and perhaps usually have been -- produced on the hole-and-slot heddles, but it is far more convenient to weave them on the inkle loom. I find among these weaves two different systems of threading in general use -- one typical of Scandinavian and European belt-weaving and the other typical of "native" American weaving. The latter system of threading may be woven to produce two entirely different effects, and is found in the belt-weaving of the Navajo Indians, in weavings from Mexico, Guatemala, the Philippines, and South American countries.

The Scandinavian system is the simpler, so will be described first. The method of threading, and patterns for several kinds of weaving in this manner are shown on Diagram No. Four. Draft (a) and the accompanying illustration are from a Swedish piece of belt-weaving carried out in quite coarse worsted yarns. It is effective and not at all difficult to reproduce. A narrow plain-weave border (not shown on the illustration) is threaded on either side and the center part of the band, on which the pattern is woven, is threaded with two single strands in orange alternating with a double strand in red. Of course other colors may be used if preferred, and a different border might be desired. Any of the small threadings on Diagram No. Three, for instance, might be used for wider borders.

When woven in plain weave the threading produces an effect of small spots of the darker color on a foundation of the lighter color, as shown at the bottom of the illustration for pattern (a).

To produce the figure as shown, after weaving shed No. 1 -- the "down" shed -- open shed 2, -- the "up" shed, and pick up the center pair of red threads. Weave. Open shed 1 again and pick up the two pairs of red threads on either side of the center. Weave. Open shed 2, and push down the pair of red threads at the center and also pick up the next two pairs of red threads on either side of the second pick-up. And so continue as clearly shown on the illustration for pattern (a).

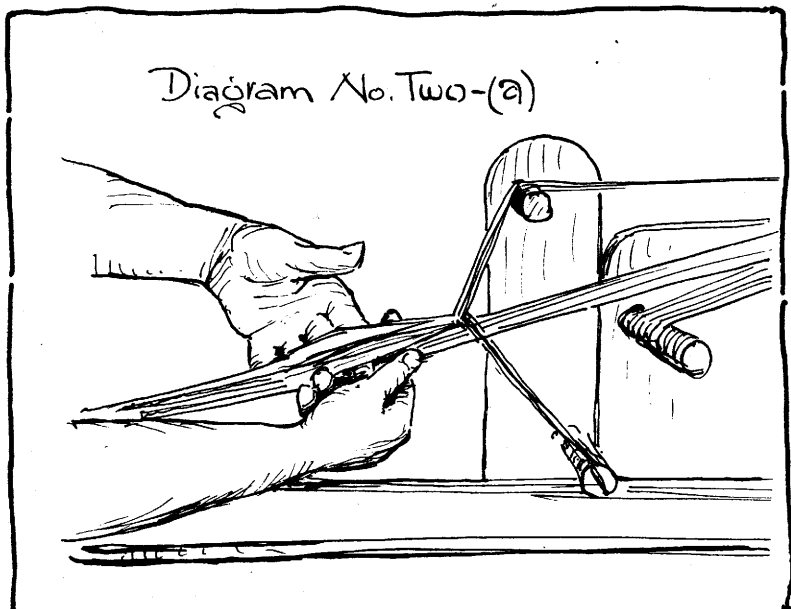

In making the pick-ups hold the hands as shown on Diagram No. Two-(a) That is, insert the fingers of both hands through the open shed, and separate the warp with the fingers where the pick-up is to be made. This is really quite a simple matter with a bit of practice. Be careful, however, in making the pick-ups not to cross the threads.

Draft (b), Diagram No. Four, is for a wide piece done in a Central European pattern, the method of weaving being exactly the same as for (a). This pattern was taken from a clever little cigarette case brought from Central Europe.

It should be noted that in weaving patterns in this technique the warp should not be drawn as close together as for patterns in plain weave, and the weft should be permitted to show to some extent. The weft should therefore be of the same color as the foundation threads of the warp, but may be somewhat coarser than the warp.

Draft (c), Diagram No. Four, though threaded in the European manner, is from a Mexican girdle, made with a series of narrow stripes in pick-up weaving between red and white stripes in plain weave. Girdles made in this manner are typical of one of the southern districts of Mexico and are undoubtedly woven on the waist-loom in general use in that country. They are usually quite wide, with thirteen or more bands in pattern weaving, but for the inkle loom, belts with three or four pattern stripes are wide enough. Each pick-up figure is woven for six inches or so, all the stripes being woven in the same figure. Solid bands or a small detached figure are woven to separate the changes of pattern. And for the length of the girdle each section is in a different figure. It is surprising to find how many variations may be produced on five pattern threads by the simple process of picking up and pushing down. The illustration shows a few of these little figures; others will readily suggest themselves to the weaver.

Though the European threadings lend themselves to a great variety of patterns, as simple or as intricate as one chooses, the figures are all of the geometric type, based on diamonds or slanting lines. A great deal more freedom of design is provided by the native American system of threading, shown on Diagram No. Five. In this form of threading the warp is set up in two colors, all the threads of the foundation color being taken through heddles and all the pattern threads being warped "open." A border, -- wide or narrow as may be preferred -- is threaded on either side of the wide central band of pattern weaving. In the Navajo weavings of this type it appears traditional to make the border of two fairly wide stripes in red and vivid green, the pattern weaving being in black over a "natural" white foundation. A narrow edge in natural is also used, as the weft is in natural. In the Mexican pieces the pattern threads are almost invariably dark blue, with the foundation in natural and the border in red. The pieces from Bolivia are often in many colors. A similar weave is seen in pieces done in the Mountain Province of the Philippines. These pieces are woven on waist-loom provided with a hole-and-slot heddle and are quite wide -- usually with broad stripes in plain weaving and narrow bands of pattern weaving. The traditional figure appears to be a snake-man-and-egg motif that no doubt has some tribal symbolic meaning. Wide pieces cannot, of course, be woven on the inkle loom, but the narrow pattern motifs from these Philippine weavings can be reproduced for belts and narrow fabrics.

The pieces from the Philippines and those from Bolivia and Guatamala are ordinarily set up with pattern threads and back-ground threads of about the same grist, -- the pattern yarn being only a little coarser than the back-ground. This is indicated on draft (a), Diagram No. Five. The Navajo and Mexican pieces however are usually made with the pattern threads at least twice the weight of the background threads, and usually a good deal coarser than this. In these pieces the pattern threads are ordinarily a hard-twisted wool and the background in natural cotton.

Two entirely different methods are used in weaving belts on these forms of set-up. The simple pick-up, as illustrated at (a1) and (a2) on the diagram is the method seen in the South American, Philippine and Guatamalan belt-weaving, and for this form of pick-up there should not be much difference in grist between pattern and background. The method of making the pick-up figures is perhaps sufficiently clear from the illustration. When woven in

plain weave the threading produces crosswise bars of solid color, of course. When weaving pattern figures weave Shed No. 2 -- the "up" shed -- without any pick-ups. Make the pick-up always on the "down" shed. For instance, to make the figure illustrated at (a2) on the diagram, beginning at the bottom, with the down shed open, pick up a black thread on either edge and one on either side of the center thread. Weave. Weave the up shed plain. With the down shed open again, pick up the second thread from the edge, and each alternate black thread for six threads. Omit the three threads at the center, and pick up six black threads to match the first six. Weave the up shed plain. On the next down shed, begin the pick-up with the third black thread, and so on. This is quite simple, but requires concentration as to pick up the wrong thread spoils the design.

In this form of weaving draw the weft close so that it is completely covered by the warp, and drive the weft-threads together as closely as possible.

The second technique, practised by the Mexican and Navajo weavers, is a bit more difficult. When woven plain, the threading produces cross-wise bars as for threading (a), but the dark part of the warp being so very much coarser than the white part of the warp, the dark bars are naturally much heavier than the white ones. Plain bars are rarely used in this weave except to start and finish the piece. A pattern effect similar to the pattern effect on threading (a)-- with most of the dark threads on top -- is woven against a background effect with most of the black threads on the under side, so that there are dots of dark color instead of solid dark bars. The pattern effect is livelier and more prominent as a result of weaving in this manner.

To familiarize oneself with the technique it is well to practise weaving the pattern effect all across, and then the back-ground effect all across, till these are easy. To produce the pattern effect, weave as described for (a). That is, weave the up shed plain, and on the down shed pick up every other pair of dark threads all across. Weave the up shed plain, and on the following down shed pick up alternating dark pairs as before, beginning with the second thread instead of with the first. Repeat these four sheds as desired.

To weave the background effect, weave the down shed plain, and on the up shed drop every other thread. That is drop the first thread, the third, the fifth and so on. Weave the following down shed plain. On the next up shed drop the second, fourth, sixth and so on. Repeat these four sheds as desired.

For the figures the two systems are combined. For instance, in weaving the Navajo figure illustrated at (b2) on the diagram begin this way: weave the down shed plain. On the following up shed, drop the first, third, fifth and seventh threads; leave up a group of seven threads at the center; drop the following thread, and the alternating threads out to the margin. Open the down shed and pick up the center thread skip one and pick up one on either side of the center thread. The drawing will serve as a guide.

In the Navajo weavings of this order the traditional figures appear to be geometrical, or so highly stylized that no naturalistic intention can be recognized. A few traditional figures appear again and again, usually set some distance apart along the length of the piece. The Mexican pieces on the other hand show figures of animals, men and women, flower forms and so on. One of the most amusing is the dancing humanistic figure illustrated at (b1). I take it this represents a warrior in a feather bonnet doing a war-dance. It appears on most of the Mexican belts of this type and may have some historic meaning.

Note that when weaving in this second technique, the weft should not be drawn as tight as for the Bolivian weave, and should be permitted to show a little. The weft therefore should be white like the background threads, but should be somewhat coarser. Note also that though the pick-ups should as a rule alternate regularly, the exigencies of the design sometimes make it necessary to pick up the same thread twice, at the "return" points of the figure. For instance note the threads making the elbows and neck and nose of the dancing warrior.

The above notes cover the techniques in most general use by "inkle" weavers, but of course there are many other weaves that might be adapted for inkle loom weaving. Two of these are shown on Diagram No. Six.

At (a) is a threading draft for a Bolivian Indian weave that is similar to the weave at (b) Diagram No. Five, though somewhat more intricate. Instead of making the pattern pick-up against a plain back-ground, however, both figure and background are picked up. The warp for this weave should all be in material of the same grist -- perle cotton #5 is excellent for the purpose -- and as a rule the figures in this weave are made in light color with the background set in stripes of several dark colors, as noted on the diagram. Thread alternate dark and light threads as shown on the diagram, but make the pick-up in pairs instead of by single threads. When woven in plain weave this threading makes cross-wise bars, of course, as in the other native American threadings. To weave the plain light effect shown at the bottom of the sketch, weave the down shed plain, and on the up-shed pick up alternate pairs of light threads. For the plain dark effect reverse this procedure: weave the up shed plain and on the down shed pick up alternating pairs of dark threads. For the figures, pick up the background when weaving the down shed, and pick up the figure when weaving the up shed. This is indicated on the sketch at (a) on the diagram. The sketch, however, does not give a true idea of the woven effect, which is richer and handsomer than that of any of the other weaves in this group. On the sketch, and also on the draft, a narrow border of six threads of each color is indicated. Several narrow borders may be used, and plain stripes in color may be set between the borders. Many quaint figures of trees, birds, animals and human figures appear on these weavings. A few typical figures are shown on the sketch. The weft for this weave should be somewhat coarser than the warp and drawn tight enough to bring the warp close together, covering the weft completely.

An interesting Mexican belt-weave is shown at (b), Diagram Six. For this set up the loom in material of one color -- usually natural white, but any preferred color may be used. Within the edge set two threads of contrasting color to mark the boundaries of the pattern weaving. The pattern effect is produced in skips of colored weft-material -- wool, silk, rayon, or what one chooses -- over a foundation in plain weave with a fairly coarse weft of the color of the warp. Many colors may be used, and the effect is very lively and amusing. To weave, open the down shed and put through the plain weft. Then pick up on a small pick-up stick the threads corresponding to the background, leaving skips where the pattern thread is to appear. Do this on the open shed picking up only the raised threads, and skip over the borders to the inside of the two colored warp-threads. Now insert the pattern material through the shed made by the pick-up stick. Open the up shed and repeat the process, first weaving the plain weft, then making the pick-up and putting in the pattern material. The pattern threads should not cross the colored warp-threads. The plain weft should be drawn close so that it is completely covered, and should be beaten together as firmly as possible. The pattern weft rides on top of the plain weft, and no color shown on the wrong side of the fabric. On the diagram are sketched a number of typical figures taken from Mexican weavings of this type.

No doubt the inkle loom is capable of many other weaves, and these notes are not presented as final and all-inclusive. It is hoped, however, that they will add to the pleasure of inkle loom weavers, and offer them enough variety to show the possibilities of this ingenious little piece of textile equipment.

*May M. Abrah*



# Diagram No. three — Patterns in Plain Weave

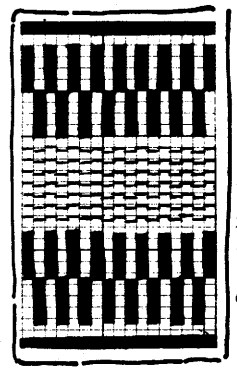
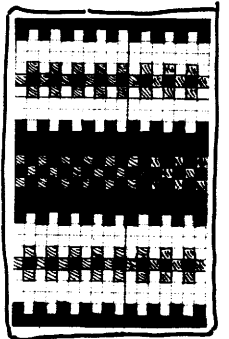
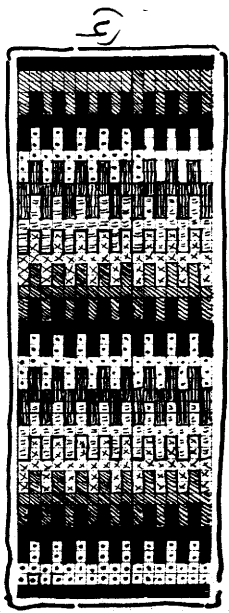
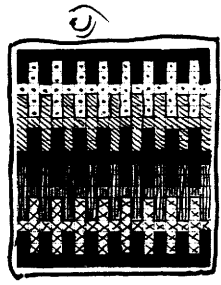
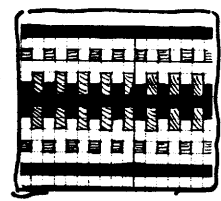
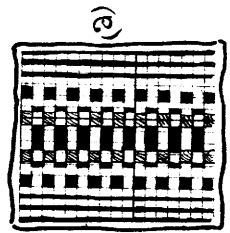
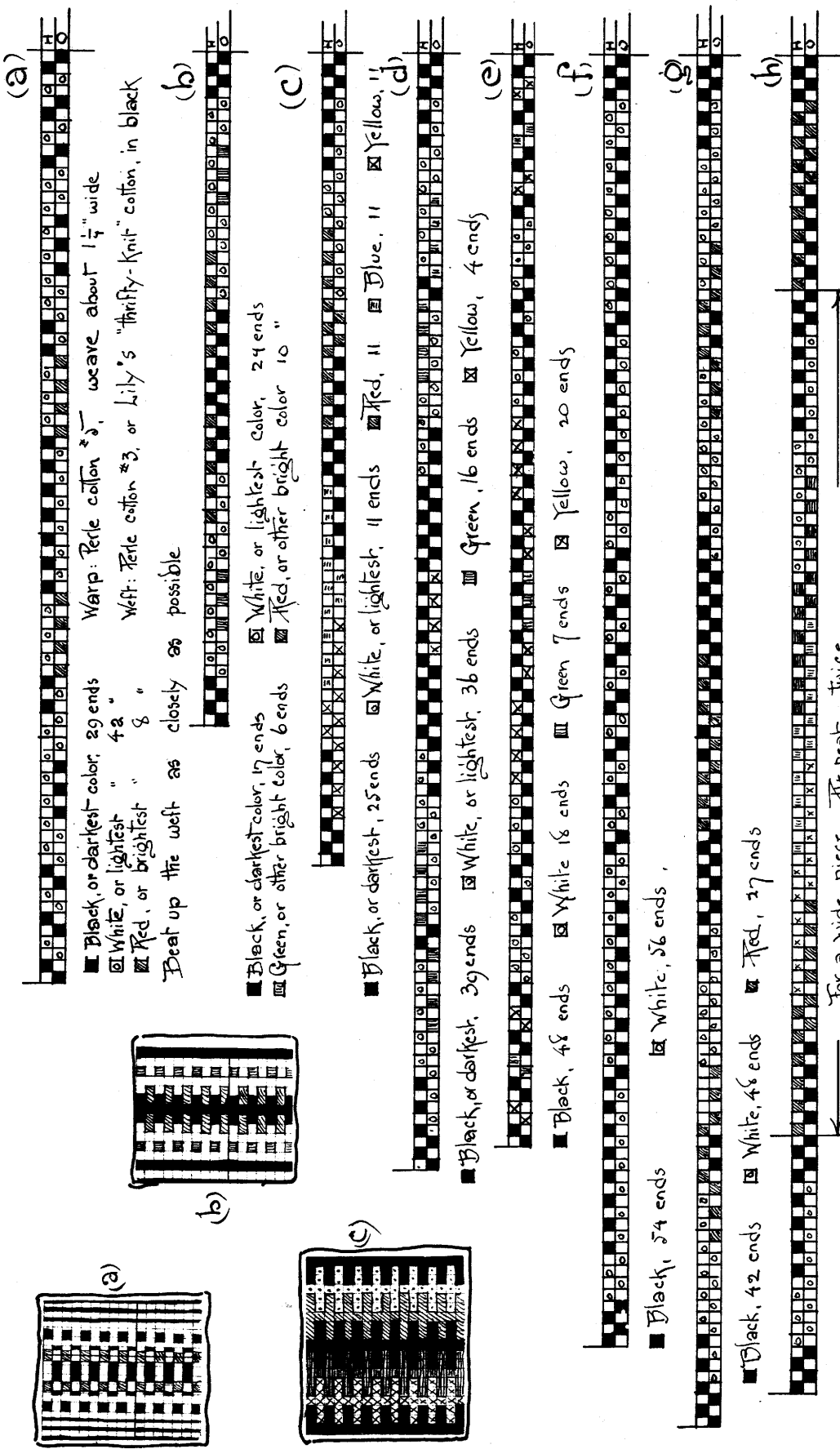

# Diagram No. Four

## Threadings for Pick-Up Pattern Weaving — European Method

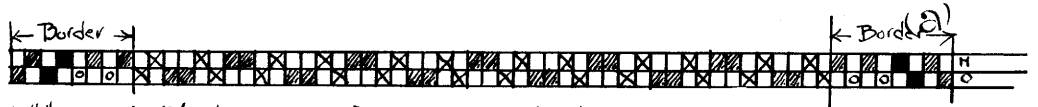
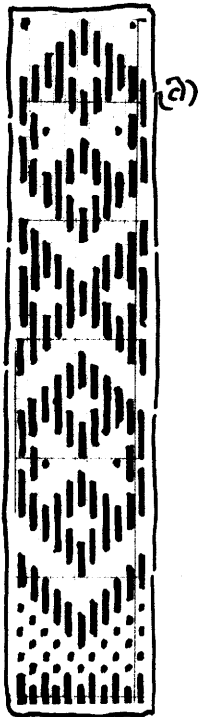

□ White, 2   ■ Black, 4   ⊠ Orange, 24   ⊞ Red, 30

Warp: Coarse knitting yarn   Width, 2"  
Weft: Strand cotton — orange

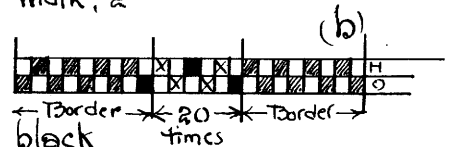

■ Fine cotton, red.   ■ Coarse cotton, black  
or dark blue

Width, 3"

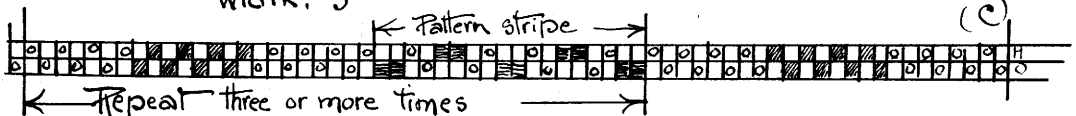

□ Fine cotton, white   ⊠ Fine cotton, red  
■ Coarse cotton or hard-twisted wool — navy blue

Width, three repeats, 2"

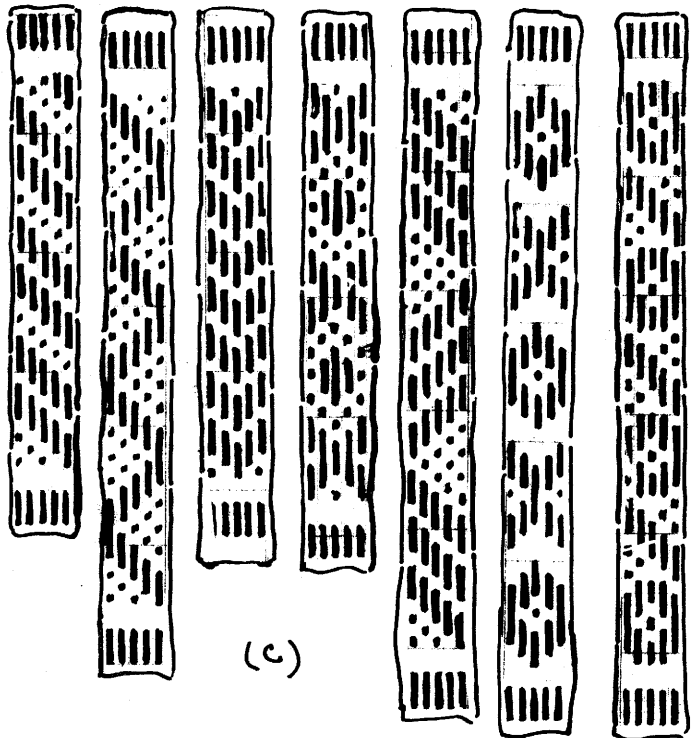
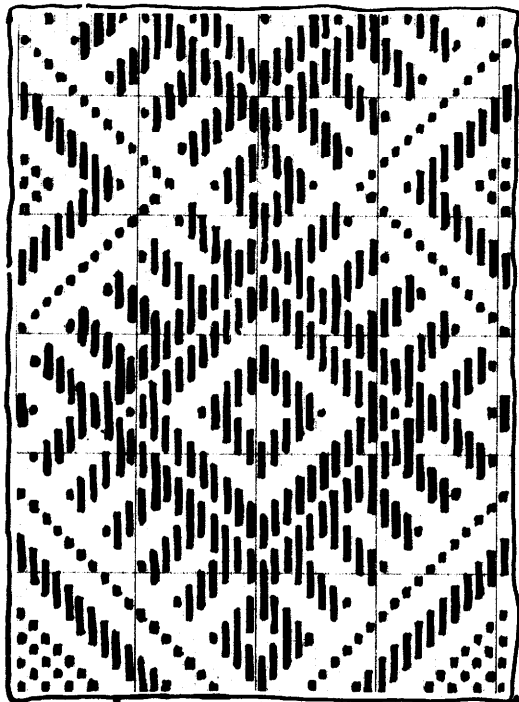

For pattern (c), weave the same figure on each stripe — for four to six inches.  
Weave plain stripes or small detached figures between changes of figure:

(b') Mexican

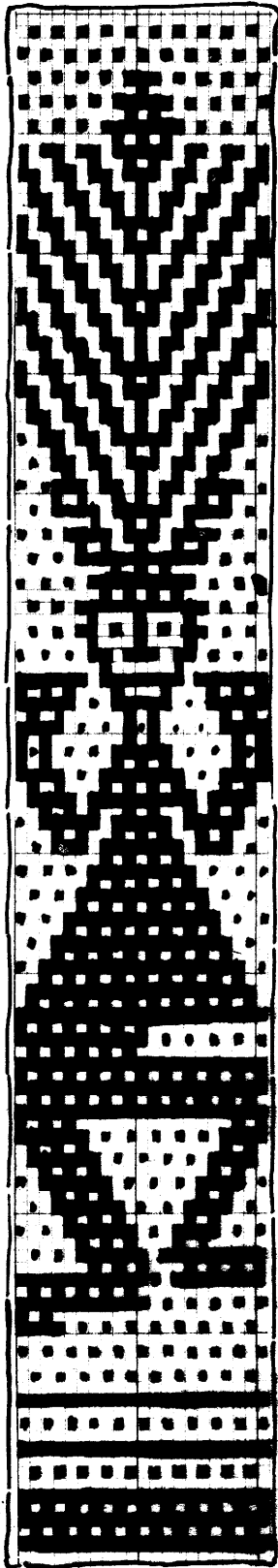

(Borders not shown on sketch)

# Diagram No. Five

Native American System

Repeat as desired for center — for pattern (a<sup>2</sup>) as illustrated, repeat for 27 dark ends. Repeat border.

☒ Perle cotton #5, color, old gold or tan  
 ■ " " #3, black  
 Weft, Perle cotton #5, color. ☒

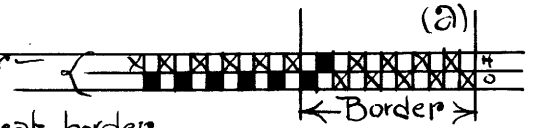

Repeat as desired for center — for figures illustrated, 21 double ends. Repeat border.

☐ fine cotton, natural.      ■ fine cotton, red  
 ■ very coarse cotton, double strands, black or very dark blue. Hard-twisted wool may be used. Weft, coarse cotton, natural.

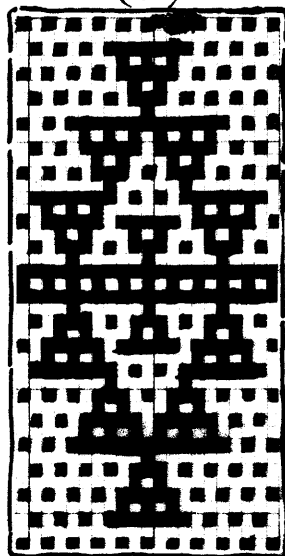
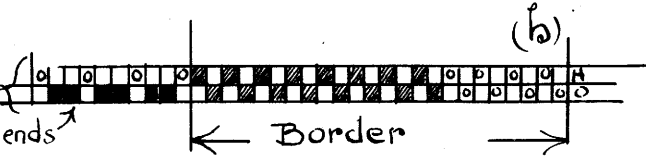

Navajo

Note: Pattern (a) should be drawn close, so that the weft is completely covered. Weave pattern (b) in a more open manner — to bring out the interesting effect of the background, allowing the weft to show a little. Beat as close as possible. To weft use a fairly fine material in natural.

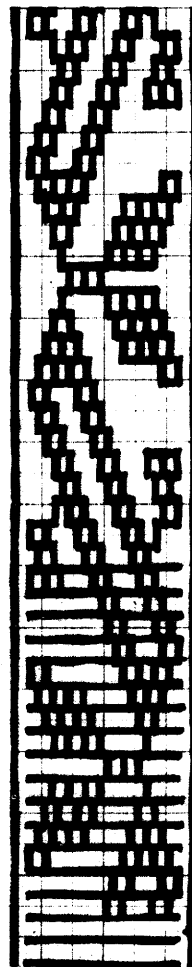

Bolivian

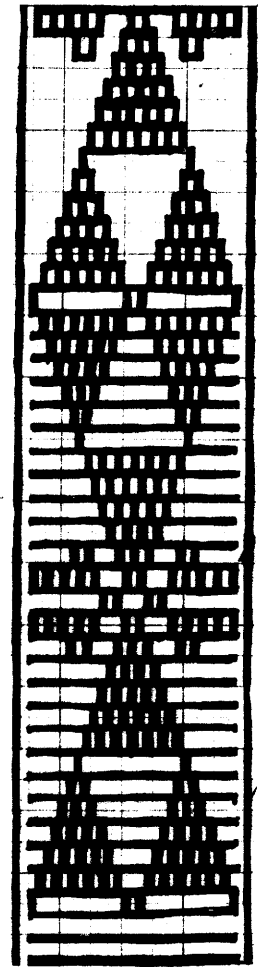
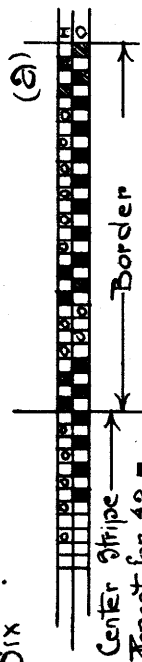
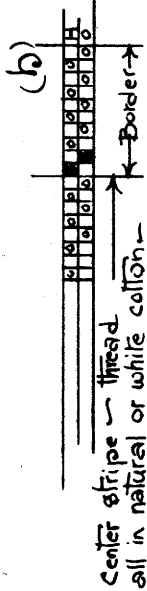

Diagram No. Six



Center stripe  
Repeat for 12  
and 12 threads  
The dark threads may be in stripes of red,  
dark green, or other dark colors. The light threads  
should be all in natural or ecru.



Center stripe - thread  
all in natural or white cotton -  
17" x 10" or similar. 180 ends give a woven  
width of 8 1/2". The two threads that  
mark the margin may be in any color de-  
sired.

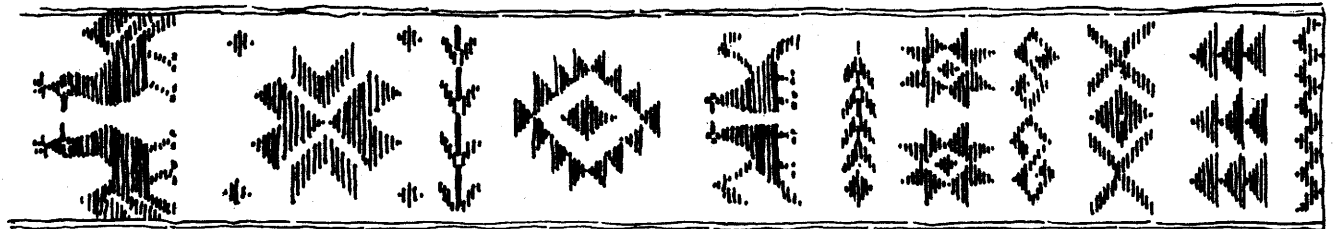

(b)

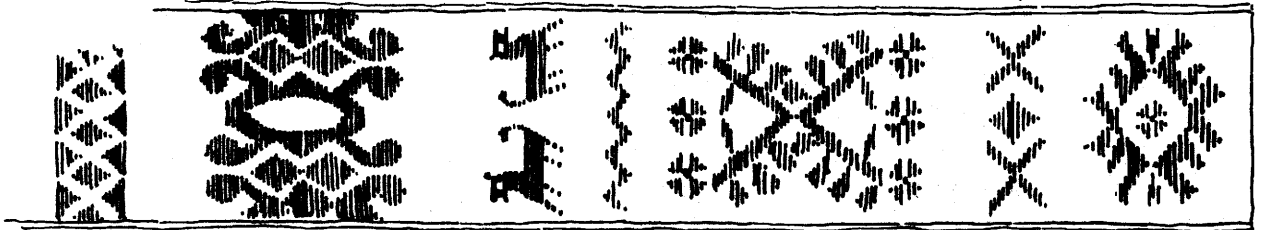

(b)

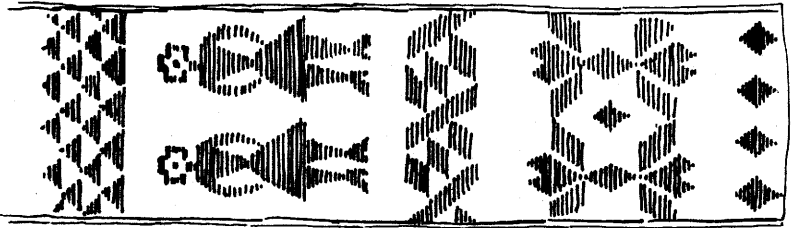

(b)