

TABLET WEAVING

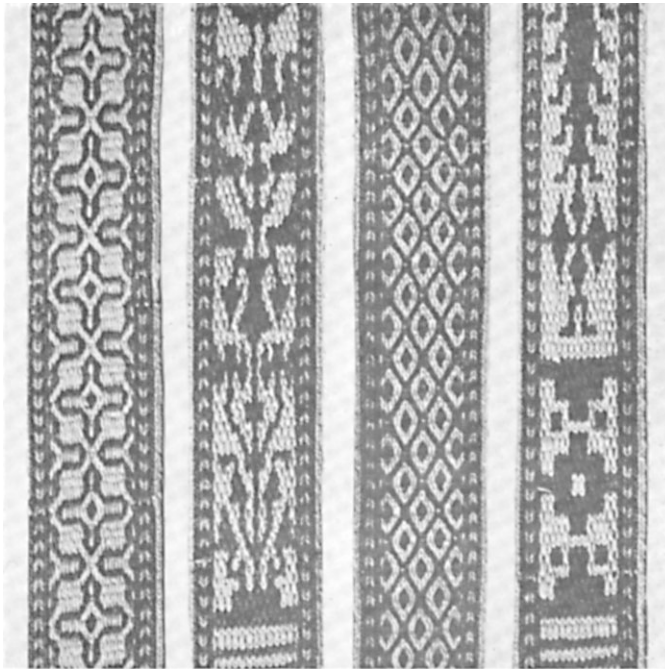

DRYAD HANDICRAFTS
LEICESTER

TABLET WEAVING

This leaflet aims at explaining simply and practically the elements of tablet weaving, and introduces the student to various pattern drafts.

Tablet weaving is, as its name suggests, a method of weaving with small tablets or cards in place of the usual heddles and treadles of the familiar handloom weaving. The warp threads pass through holes in the corners of these tablets forming a shed through which the weft thread passes. By using various colours in some definite order, in threading the tablets and turning these in a regular sequence, many variations of pattern can be made.

Tablet weaving differs from most other methods of weaving as all colour is in the warp. The weft thread is not seen except a very little at the edges of the weaving.

It is most suited to narrow bands and trimmings, making a very strong braid suitable for braces, tennis belts, ties, watch bracelets, gimps for upholstery, edgings for banners, etc. Very attractive bags can be made by joining strips together, especially when woven in mercerised cotton. Other strips make good handles for bags of any description.

MATERIALS AND APPLIANCES REQUIRED.

THREADS.

Strong, fine threads such as mercerised cotton and macramé twine, are most suitable. The weft thread should be a little finer than the warp thread. Wool can be used if it is tightly spun but is bulky if many tablets are used.

TABLETS.

The tablets or cards most generally used are 2" square, rounded at the corners with a hole at each corner. They can be of any thin, smooth material, but it must be strong and not easily bent. A beginner will find thick card very suitable, and may make them herself, but the ideal material is celluloid. For convenience in threading

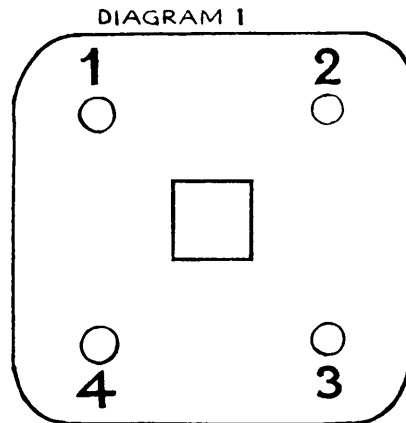

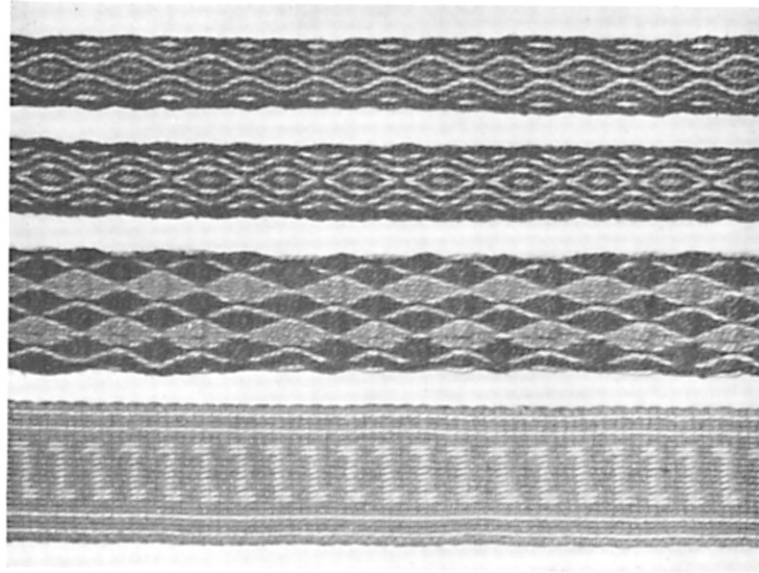

PLATE 1. EXAMPLES OF BRAIDS WOVEN IN
MERCERISED COTTON

when various colours are used and to mark the direction in which the tablets are turned, the holes are numbered as shown in illustration. The width of the braid depends on the number of these tablets used. This will be fully understood later.

It is convenient to have a small square hole cut in the centre of each tablet through which a stick can be passed. This will keep the tablets in order either when tying or untying the warp, or when the weaving is set aside for a time. Some have found it a good plan to paint each of the four edges of the tablet a different colour. It is easy then to check the misplacement of any tablet without having to look through at the numbers. It is a help also in pattern weaving, if the setting of the tablets is noted by their coloured edges.

SHUTTLE.

This is required for holding the weft thread in passing it through the warp. A netting shuttle is useful here.

BEATER.

For this purpose a bone paper folder is quite satisfactory, but any

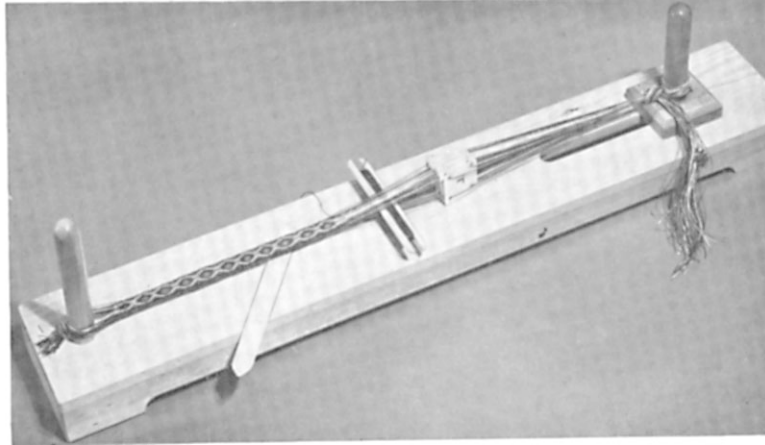

PLATE 2. TABLET WEAVING BOARD IN
WORKING POSITION

similar object will do. In Eastern countries where this weaving is practised heavy beaters are used.

LOOM OR SOME SUBSTITUTE to which the ends of the warp threads can be secured.

Only a very simple apparatus is necessary. An illustration of a simple loom is shown in the plate above. The ends of the warp threads are fastened to the two upright posts which are fixed to a board. At one end of the board a slot is made and the post is fitted underneath with a large wooden nut, so that it can be adjusted as required to tighten the warp.

Perhaps, however, one of the most convenient and usual positions for weaving is to fasten the warp threads to a ring attached to the weaver's belt while the other ends are tied to any hook on a wall or table as the weaver may contrive, so that the braid is directly in front and the tablets are turned towards and away from the weaver. Warping posts clamped to a long table are also useful, and in this case the ends of the warp are fastened to the posts in the same way as with the loom above. See also diag. 7.

For convenience throughout this leaflet, the turning of the tablets will be referred to as towards the right or left as the case may be.

THREADING AND TURNING THE TABLETS.

A little explanation and practice in the threading and turning

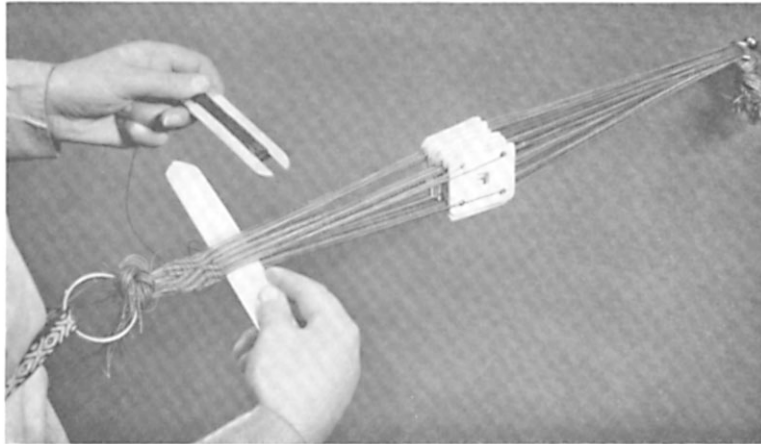

PLATE 3. WAIST LOOM METHOD

of the tablets would be useful before starting to weave an actual braid.

Thread a tablet as follows:—

A blue thread through hole No. 1; shown on diagram by dotted line.

A yellow thread through hole No. 2; shown on diagram by a wavy line.

A green thread through hole No. 3; shown on diagram by a broken line.

A red thread through hole No. 4; shown on diagram by a line of crosses, and secure them at both ends, see diag. 7, and pass a weft

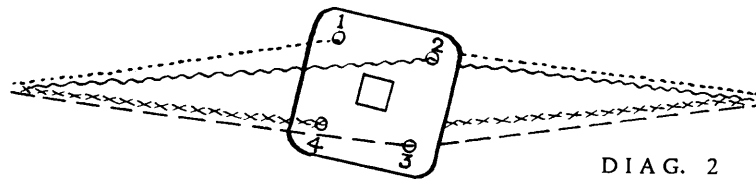

DIAG. 2

thread through the shed, separating the threads 1 and 2 from threads 3 and 4.

Now turn the tablet one quarter-turn to the left, bringing No. 1 hole in the place of No. 4 hole, and No. 2 hole in the place of No. 1 hole, etc., thus

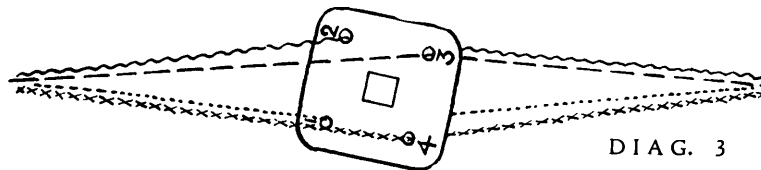

DIAG. 3

and pass a weft thread through the shed, separating threads Nos. 2 and 3 from threads Nos. 1 and 4.

Turn the tablet a second time one quarter-turn to the left thus,

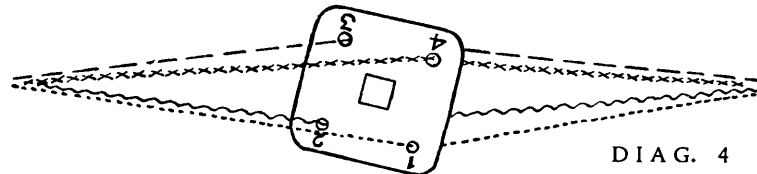

DIAG. 4

and pass a weft thread through the shed, separating threads Nos. 3 and 4 from threads Nos. 2 and 1.

Turn the tablet a third time one quarter-turn to the left thus,

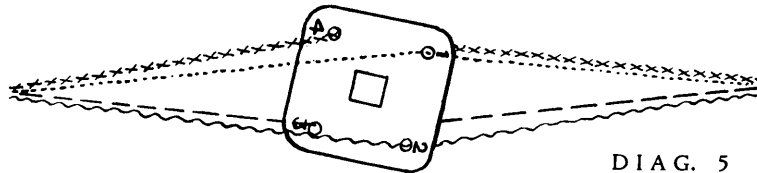

DIAG. 5

and pass a weft thread through the shed, separating threads Nos. 4 and 1 from Nos. 3 and 2.

Turn the tablet a fourth time one quarter-turn to the left thus,

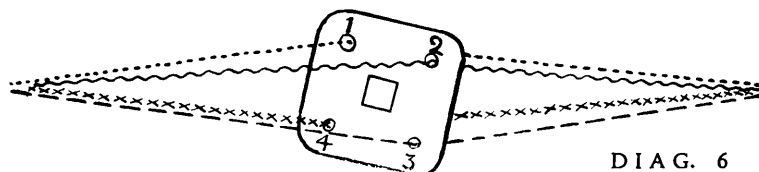

DIAG. 6

and the tablet is in its first position once more, and all the threads have been fastened into the band by the weft threads. Therefore, in all tablet weaving, each time the position of the holes is altered, i.e., after each quarter-turn, *the weft thread must pass through the warp*, making one row of weaving, so that actually each hole in the tablet is responsible for one row of weaving. It will be seen that

just as this *one* tablet has been turned, so twelve, twenty or more tablets, placed side by side, may also be turned, and with a little practice quite readily together.

SETTING UP THE WARP.

In tablet weaving a long warp is not often used. The warp threads can be measured and cut and fastened securely in some way to prevent tangling until they are needed for threading through the tablets.

Should a long warp be necessary, however, a warping board can be used in the ordinary way, making the crosses at both ends between alternate sets of four threads.

The best way to learn to weave is to begin with some simple pattern with a few tablets only, and here is given as a first example what is often called the two-way weaving, the tablets being threaded in such a way that a band can be woven with one colour on one side and another colour on the other. Other variations are also possible with this same threading which will be explained later.

1. Thread twelve tablets with two threads of the same colour (say black) down through holes 1 and 2, and with two threads of the same colour (say white) down through holes 3 and 4, placing the tablets one on top of the other with the numbers in the position shown in diagram 7.

When a loom or warping posts are used, take the warp strands, cut to the required length, and after completing the threading of each tablet tie the four threaded ends together, divide and place the loops round the left-hand peg as shown in diag. 7, twist the length of warp round the right-hand peg and tie loosely. Continue threading the tablets, placing one on top of another (diag. 8), and when completed tie the set together through the centre hole and round one side to hold in position while moving the tablets into the position for weaving (diag. 9).

To do this first remove the groups of warp threads from the right-hand peg. Then remove the loops from the left-hand peg and tie these into one knot. Divide the warp threads and place again over the left-hand peg (diag. 10) with the tablets in an upright position as in diag. 9.

Next rewind the warp ends all together round the right-hand peg and tie securely as already described (see diag. 11). Make the warp

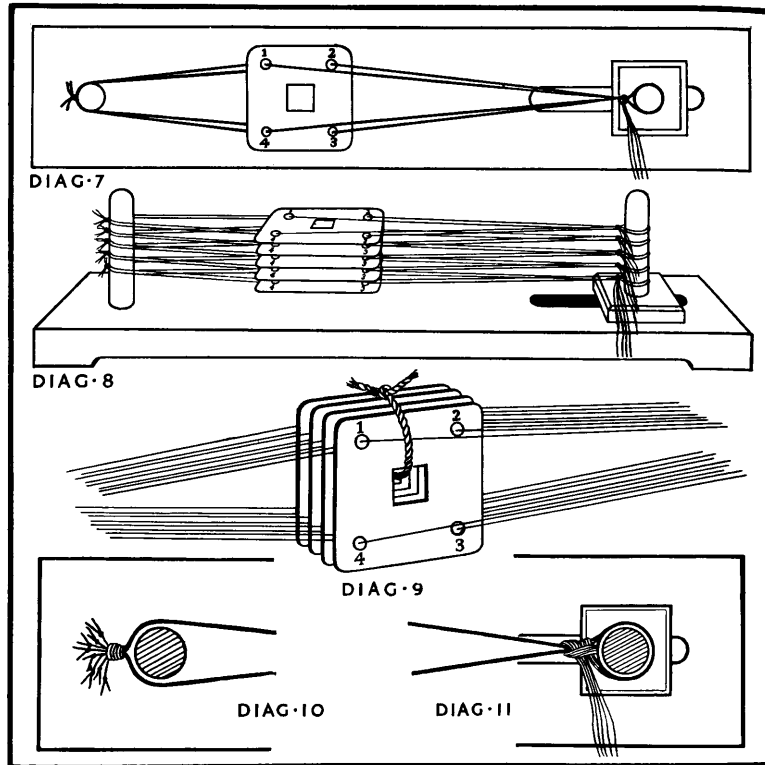

taut for weaving when using a loom by adjusting the wooden screw nut attached to the right-hand peg. Plate 2 shows the tablets, with the string removed, in the correct position for weaving.

If a ring attached to a belt, as already mentioned, is used, then the warp threads must be tied securely to the ring at one end and to a hook at the other, see plate 3.

Pass the weft thread through the shed close to the left-hand peg. Now turn the tablets one quarter-turn to the left, pass the second row of weft through this shed and continue with two quarter-turns to the right and two quarter-turns to the left, passing the weft thread through the shed after each quarter-turn, and beating the rows of weaving close together with the beater.

If this is continued, the woven band will be black on one side and white on the other.

If you wish the colours to exchange places, when the tablets are in their original position turn them two quarter-turns to the right at first, and then two to the left.

If the weaving is examined, it will be seen that of all the four threads passing through the four holes of each tablet only one is visible on the surface of the finished braid. Therefore, *each tablet is only responsible for one warp thread in the width of the braid*, so that if twelve

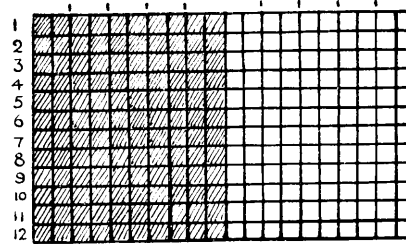

P A T T E R N 1

tablets were used, the braid would have 12 warp threads showing. This is important in planning patterns, as will be seen later.

As the weaving progresses, it will gradually get out of reach, so that the woven piece must occasionally be rolled up and fastened securely.

2. With the tablets in the original position, see diagram 9, leave the first six tablets untouched, but before beginning to weave, turn the remaining six tablets two quarter-turns to the right, thus reversing the position of the black and white threads. Then weaving as before with two quarter-turns to the left and two quarter-turns to the right, will produce a band half black and half white on both sides.

The colour can be reversed as in pattern 1.

3. With the tablets in the original position, diagram 9 before weaving, turn the four middle tablets two quarter-turns to the right, thus reversing the position of the black and white threads in these four tablets. Then weaving as before, using all tablets, with two quarter-

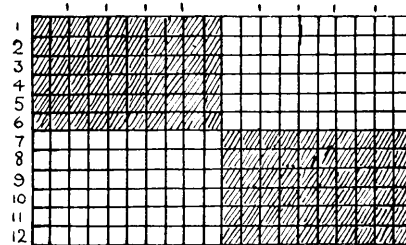

P A T T E R N 2

turns to the left and two quarter-turns to the right, will produce a woven band with a black stripe at each edge and a white stripe in the middle on one side, and white stripes at each edge and a black stripe in the middle on the other side.

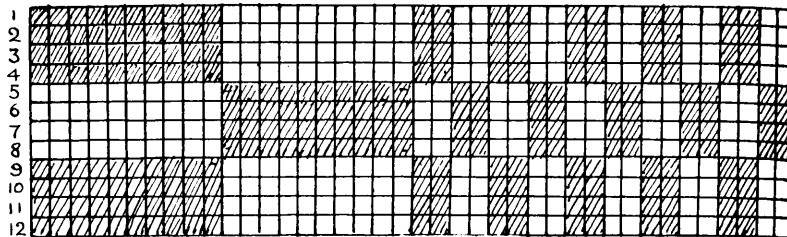

PATTERN 3

To reverse the stripes when the tablets are in the original position, turn the tablets two quarter-turns to the right first, and then two to the left.

If turning is continued in one direction, a chequer pattern is produced.

When the threads have become too tightly twisted through being turned in one direction only, reverse the turning. In order to avoid an interruption of the pattern which will occur if the tablets are immediately reversed (these having been turned in one direction and now occupying their original position), turn one more quarter-turn in whichever direction the tablets have been turned and then reverse. See pattern 3a.

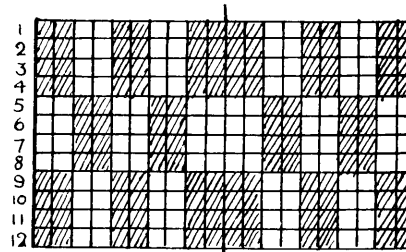

TURNING REVERSED
PATTERN 3 A

4. Let all the tablets occupy their original position. Leaving tablets 1 and 2 as they are, turn tablets 3 and 4 one quarter-turn to the right, and tablets 5 and 6 two quarter-turns to the right. Repeat from beginning for the other six tablets, leaving 7 and 8 in their original position like tablets 1 and 2, and turning tablets 9 and 10 and tablets 11 and 12 like tablets 3 and 4 and 5 and 6 respectively. Then four quarter-turns to the

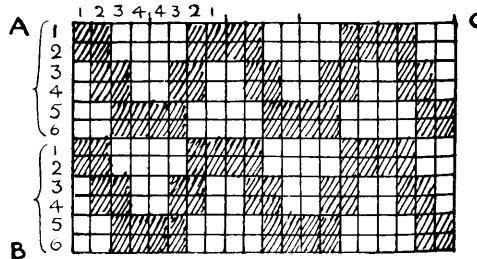

PATTERN 4

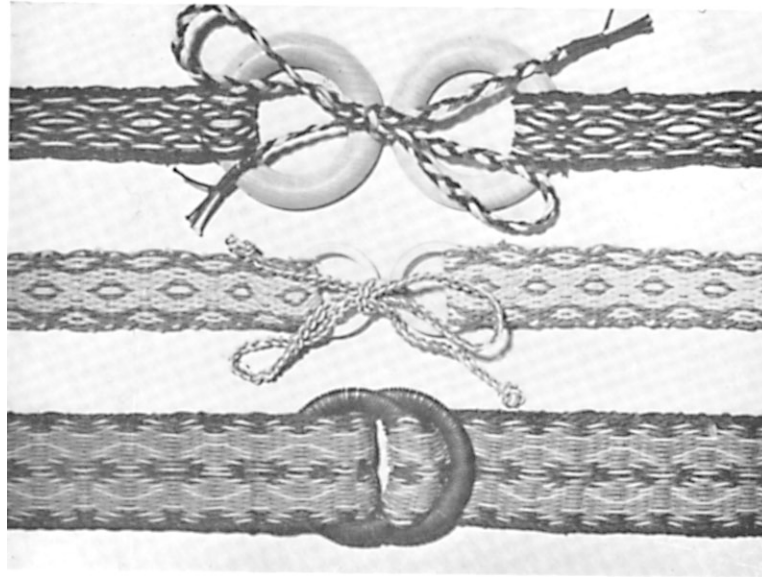

PLATE 4. BRAIDS WOVEN IN MACRAME TWINE BY STUDENTS OF THE EDUCATION DEPARTMENT (WOMEN'S DIVISION), THE UNIVERSITY, BIRMINGHAM.

left and four quarter-turns to the right produce an undulating pattern of black lines on one side.

On the reverse side the undulating line will be white.

In all the foregoing illustrations, it will be seen that each square in the width of the braid, that is from A to B, see 4, represents one tablet, and that twelve tablets have been used; also that each square in the length of the braid, that is from A to C, represents one of the four holes in the tablets.

This shows the beginner how tablet weaving patterns can be planned on squared paper, and how easily the tablets can be threaded to produce a given pattern when this is understood.

4a. In the last pattern, if the turning of the tablets had not been reversed after four quarter-turns to the left, but had been continued

to the left only, the following pattern would result, see 4a.

So far, only one method of threading the tablets has been given, see diagram 12, in which the tablet was threaded through the holes from the *top side* of the tablet. They can, however, be threaded from the *underneath* of the tablet as shown in diagram 13.

Then by threading the tablets alternately all holes of one from the top side and all holes of one from the underneath side it will produce a plaitlike or chain effect in the weaving.

Two tablets threaded thus at the edge of a braid in the same colour make a good border, and as reversing the cards at short intervals makes a bad edge, some weavers prefer to turn the border tablets separately from the pattern, as long as possible in one direction.

In all patterns in which the lower half of the pattern is a repeat of the above half in reverse order, as in the following patterns illustrated, the tablets for the top half of the braid should be threaded from the top side, and the tablets for the bottom half from the underneath, as in this way the pattern lines will be found to meet better in the centre.

In all these threadings a different pattern results on the reverse side of the braid.

5. In this and all other patterns given in this leaflet the first four squares, horizontally, from the left of the pattern draft, indicate the colours of the threads passed through the respective holes in the tablet and the numbers at the side show the number of tablets

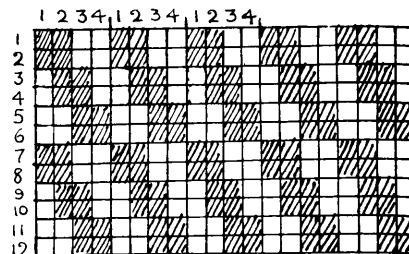

PATTERN 4 A

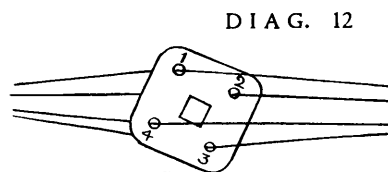

DIAG. 12

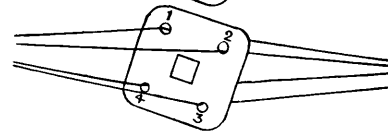

DIAG. 13

required for the threading of the braid. Ten tablets are required for this pattern, and they are threaded as indicated on the pattern draft, starting with No. 10 tablet so that when the threading is finished No. 1 tablet is on top and No. 10 the bottom of the pile of tablets, not forgetting, as already mentioned, to place them so that No. 1 hole is in the position shown in diagram 7.

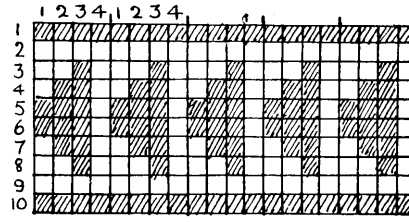

PATTERN 5

The following table is given as a guide to beginners, who should write out all patterns in this way before beginning the threading process.

		<i>Holes.</i>			
		Tablets. No. 1.	No. 2.	No. 3.	No. 4.
Thread from above	{	1 ... black	black	black	black
		2 ... white	white	white	white
		3 ... white	white	black	white
		4 ... white	black	black	white
From below	{	5 ... black	black	black	white
		6 ... black	black	black	white
		7 ... white	black	black	white
		8 ... white	white	black	white
		9 ... white	white	white	white
		10 ... black	black	black	black

In this pattern the tablets are turned four quarter-turns to the left in succession. This will cause the warp threads to become tightly twisted at the opposite end and these may either be untwisted and tied up again, or the tablets may be turned an equal number of times to the right.

6. Another simple pattern is given here.

Thread as indicated in the pattern draft, be-

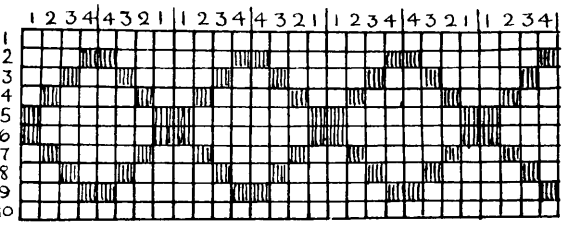

PATTERN 6

ginning again with No. 10 tablet. Thread tablets 10—6 from below and 5—1 from above.

Turn four quarter-turns to the left and four quarter-turns to the right.

This pattern may be still further developed

with the addition of more tablets on either side as shown in pattern 6A. Thread tablets 12—7 from below and 6—1 from above.

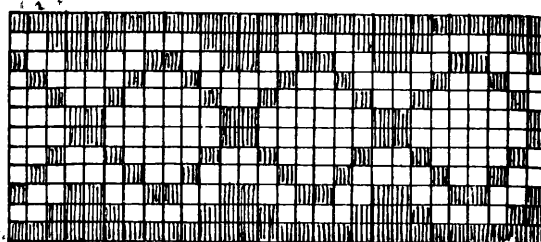

PATTERN 6 A

7. The following pattern is effective in three colours, and is threaded as follows, beginning from No. 12 tablet, so that No. 1 tablet is on top of the pile of tablets when they are threaded.

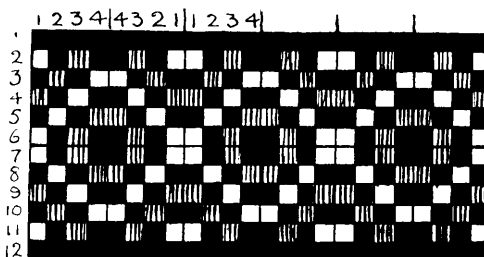

PATTERN 7

Thread tablets 12—7 from below and 6—1 from above.

8. This pattern for a broader braid is taken from the French book on Tablet Weaving (Le Tissage aux Cartons) by A. von Gennep and G. Jéquier.

It is threaded as follows, beginning with No. 22 tablet, so that No. 1 tablet is on top of the pile when the threading is completed.

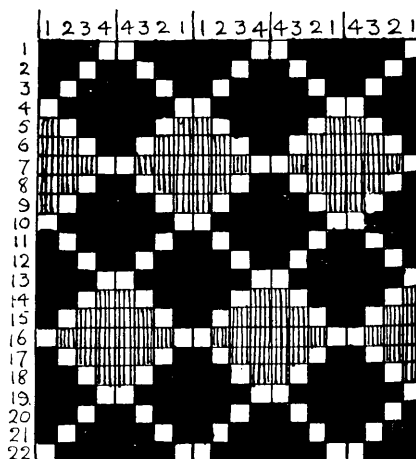

PATTERN 8

Thread the first four tablets 22—19 from above and the next three 18—16 from below, continuing threading three from above and three from below throughout. Turn four quarter-turns to the left and four quarter-turns to the right.

9. The following illustration shows the variation in pattern that can be produced by varying the number of times the tablets are turned in one direction.

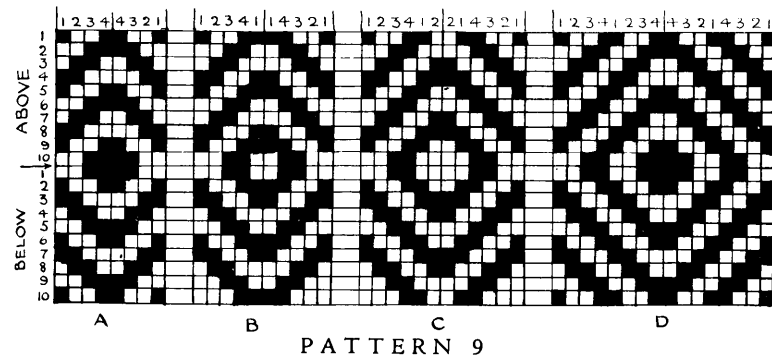

A, B, C, and D are all threaded alike, but A is turned four quarter-turns to the left and four to the right.

B is turned five turns to the left and five to the right.

C is turned six turns to the left and six to the right.

D is turned eight turns to the left and eight to the right.

When weaving try to follow the pattern, and do not depend entirely on counting. It is easy to get confused at first and tablet weaving is not easy to undo. If a mistake has been made, cut the weft thread and untwist each tablet to the correct position.

There are many ways of finishing the braids, according to the use that is to be made of them. One of the best ways is to leave a fringe, knotting the threads loosely to prevent unravelling, or braiding a number of threads and then knotting them.

10. Ten tablets are required and they are threaded in four colours as indicated in the illustration from the top side as in diagram 12, starting with No. 10 tablet so that No. 1

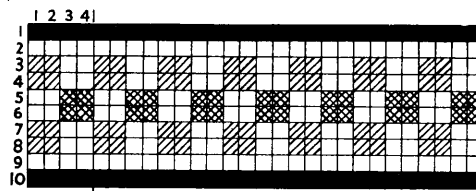

tablet is on the top when the threading is completed.

For the weaving the tablets are turned continuously towards the left, passing the weft thread on the shuttle through the shed at each quarter-turn.

11. Fourteen tablets are required and they are threaded in three colours as indicated in the illustration starting with No. 14 tablet and threading this and the following six

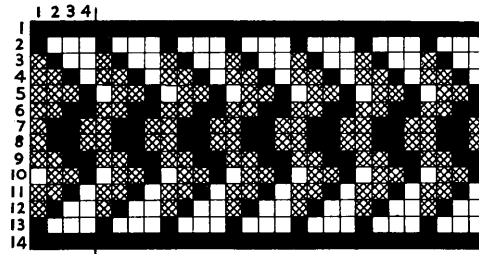

P A T T E R N 11

tablets from underneath as in diagram 13, and the remaining seven from above as in diagram 12, so that when the threading is completed No. 1 tablet is on the top.

For the weaving the tablets are turned continuously towards the left and the weft thread passed through the shed at each quarter-turn.

This leaflet incorporates pattern drafts from "Tablet Weaving," by M. W. Peach, first published by the Dryad Press in 1926 and now out of print. The frontispiece shows a selection of Indian braids.

This leaflet, one of a series covering practically every branch of craftwork, is published by

DRYAD HANDICRAFTS
SAINT NICHOLAS ST., LEICESTER

London Showroom: 22 Bloomsbury Street, W.C.1.