

ENGLISH, FRENCH AND GERMAN DICTIONARY OF TECHNICAL TERMS.

# TEXTILE EXPORTER

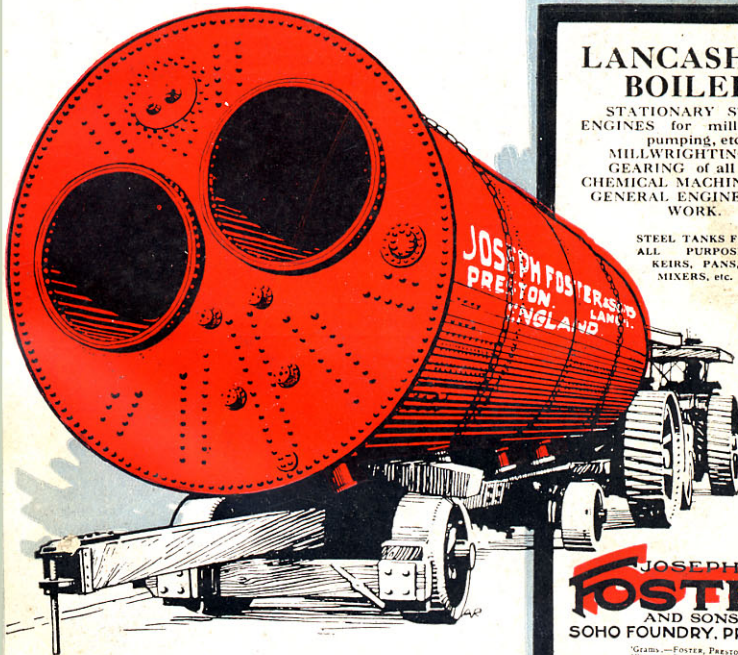

## LANCASHIRE BOILERS

STATIONARY STEAM ENGINES for mill driving, pumping, etc.  
MILLWRIGHTING and GEARING of all kinds.  
CHEMICAL MACHINERY, etc  
GENERAL ENGINEERING WORK.

STEEL TANKS FOR ALL PURPOSES  
KEIRS, PANS, MIXERS, etc.

JOSEPH  
**FOSTER**  
AND SONS.  
SOHO FOUNDRY, PRESTON

Works.—Foster, Preston  
Phone.—Preston 99  
London Office:  
134, FLEET ST., E.C. 4

# Wallwork

## PATENT PIECE GOODS STAMPING MACHINE

Perfect and uniform Impressions. New Patented Method of Adjusting Stamps. Speed, 1,200 to 1,800 per hour. Dhooties 3,000 per hour. Several colours stamped simultaneously. Self-inking and small amount of colour used.  $\frac{1}{4}$  h.p. only. May be worked by inexperienced hand. Any thickness of piece may be stamped. Ordinary hand stamps used. Easy adjustments.

THE ONLY MACHINE WHICH  
GIVES PERFECT IMPRESSIONS  
UPON ALL CLASSES OF GOODS  
USING ORDINARY HAND STAMPS

Being of simple construction it is invaluable for export, no experience being required, and not liable to get out of order.

Any thickness of piece may be stamped up to 8 in. by simply setting the table to the required height, occupying but a few minutes.

**HENRY WALLWORK & CO., LTD., MANCHESTER.**

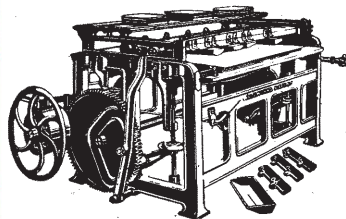

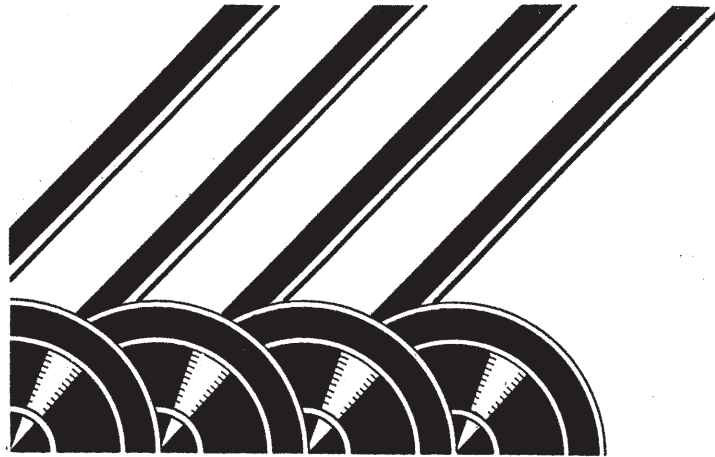

## **ROPE DRIVING**

### **THE HAPPY MEDIUM.**

Perhaps that is the best non-technical description of rope-driving. It is the Happy Medium in more ways than one. It has the smooth resilience of friction driving without the slip. It has the precision and efficiency of "positive" transmission without the trouble and expense of gears.

Rope-driving is the essence of reliability, it will withstand the most arduous and uncongenial of industrial conditions.

*Truly a happy medium of Transmission.*

**WILLIAM KENYON  
& SONS, LIMITED**  
**DUKINFIELD, MANCHESTER**

Send for our  
Booklet,



"Ropes and Rope  
Driving."

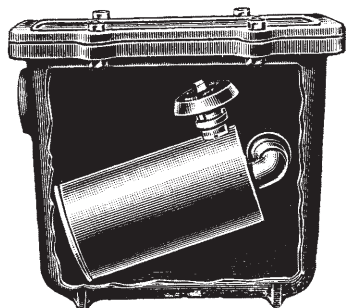

**“The  
LANCASTER”  
STEAM TRAP**  
*39 Years’ Test*

**LETTER FROM  
CUSTOMER**

“ Please quote us per return for three new valves for steam traps supplied June, 1890 ; also repair old one and put same in thorough working order.”

**OUR REPLY**

“ On examining the trap supplied 39 years ago, we find it in good order except that the valve and seat have worn slightly. Our charge for the repair will be 5/-, and for the three new valves 3/- each.”

**LANCASTER & TONGE LTD.**  
**PENDLETON** **MANCHESTER**

'Phone : Pendleton 794

'Grams : “Pistons,” Manchester

*Sole Makers of “The Lancaster”  
Steam Traps. Piston Rings,  
Metallic Packings, Wheels, etc.*

---

---

**COOK & CO. (MANCHESTER) L<sup>td.</sup>**

*Stand No. 67, Row F.*

Are shewing the Best & Cheapest *Automatic*  
**WEAVER'S KNOTTER**

This Knotter will tie any sort of yarn or rayon that can be tied on a machine. Furthermore, it is a British-made article.

*Other Specialities are :—*

**THE MacCOLL PATENT YARN CLEARER.  
THE MOSCROP SINGLE THREAD TESTING  
MACHINE.**

**PATENT FOUR-FOLD PREVENTER FOR  
DOUBLING FRAMES.**

**PATENT LAP PREVENTER FOR DOUBLING  
FRAMES, and**

**PATENT "UNIVERSAL" TAPE FASTENERS.**

Telephones :  
Blackfriars 6887. Altrincham 170.

Telegrams :  
" Travellers," Manchester.

**COOK**  
*Specialities* FOR  
SPINNERS & MANUFACTURERS

**COOK & CO. MANCHESTER, L<sup>td.</sup> 18 EXCHANGE ST. MANCHESTER** WORKS ALTRINCHAM

# **Elton Cop Dyeing Co., Ltd.**

**BURY, Lancashire.**

**Dyed Cotton Yarns  
on Cone.**

**“Brandom” (MULTI-  
COLORED)  
Yarns**

IN

**GUARANTEED FAST AND  
WASHING COLOURS.**

*Manchester Office :*

**26, CROSS STREET.**

*Leicester Office :*

**ALLEN HOUSE, NEWARKE STREET.**

*Works* { 'Phone: Bury 1383-4.  
Wire: “Cops, Bury.”

*Correspondence to Bury or Leicester, please.*

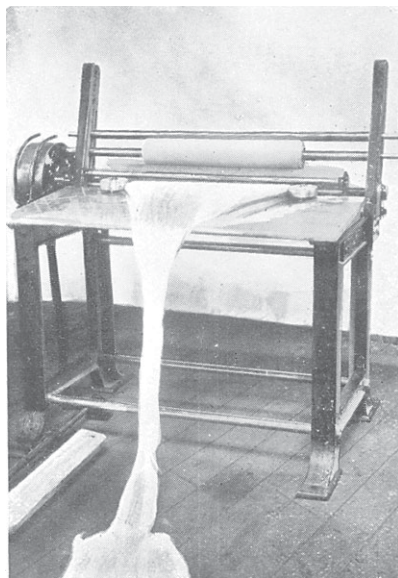

These  
**MACHINES**  
GIVE YOU  
**PRODUCTION**  
AND  
**EFFICIENCY.** !

## Opening & Rolling Machinery

for

*Stockinette Fabrics made to all requirements*

ALSO MAKERS OF

CREASING, RIGGING, PLAITING, FOLDING,  
MEASURING, LAPPING & ROLLING MACHINES

*Suitable for Silk, Artificial Silk, or any other woven  
Fabric*

# C. COOPER & SONS LTD.

SEED STREET IRONWORKS

**RADCLIFFE**

NR. MANCHESTER

TELEPHONE No. 3

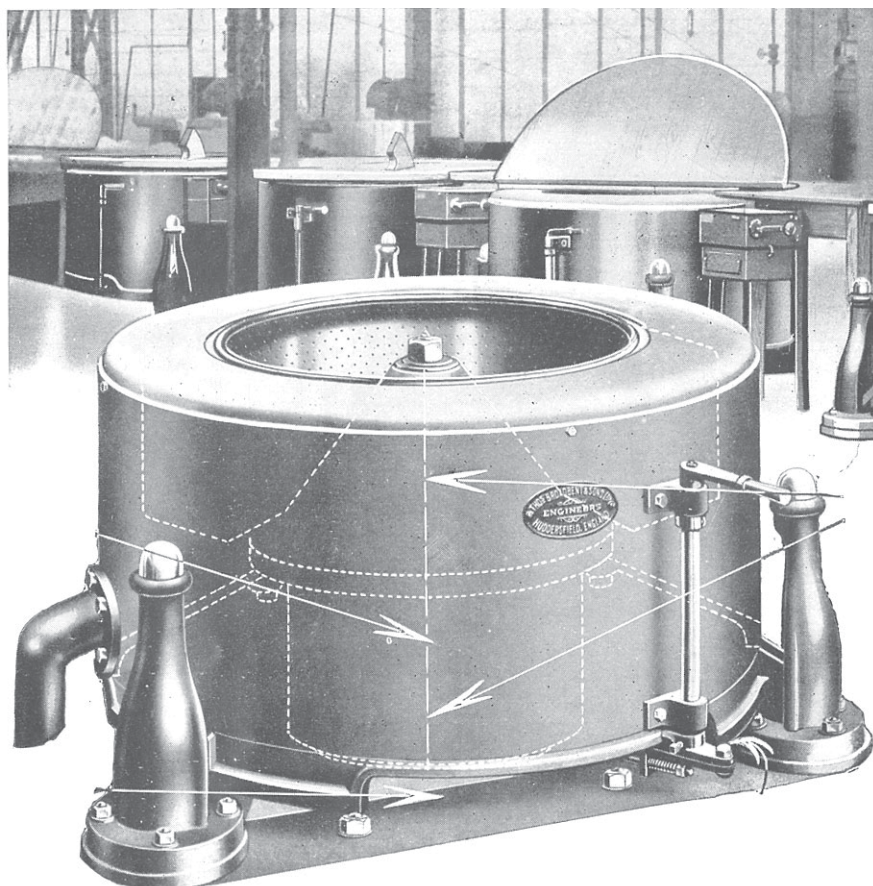

**“BROADBENT”**  
DIRECT ELECTRICALLY-DRIVEN SUSPENDED  
**HYDRO-EXTRACTORS**  
FOR  
*Maximum Dryness in Minimum Time*

---

**:: THOMAS BROADBENT & SONS, LTD., HUDDERSFIELD ::**

---



Telegraph Address:  
"Foundry, Dobcross."

Telephone:  
Marsden 10.

Codes: A B C, Bentley's,  
Western Union.

# HUTCHINSON, HOLLINGWORTH

**AND CO., LIMITED.**

Agents for Australia:  
Messrs. DYER & PHILLIPS, Pty., Melbourne.  
Agents for India:  
Messrs. GREAVES, COTTON & Co., Bombay.

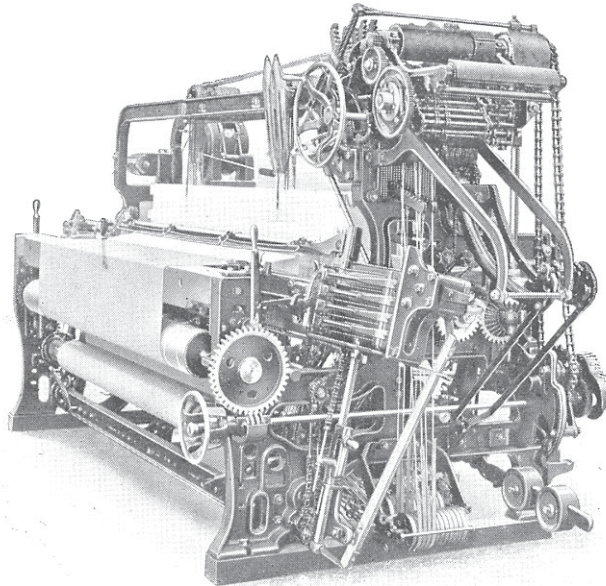

**Dobcross Hollingworth & Knowles Open Shed Fast Loom.**

MAKERS OF  
DOBCROSS HOLLINGWORTH & KNOWLES LOOMS, with 2 or 4  
Boxes and 16, 24, or 36 shafts.  
DOBCROSS UNDER PICK, single Shuttle, Fast Running Looms for  
Flannels and Blankets, etc.  
BRUSSELS & WILTON & TAPESTRY CARPET LOOMS, CHENILLE  
AXMINSTER SETTING LOOMS AND WEFT LOOMS, etc.

*Dobcross  
Loom Works,*

*Passenger Station:  
Diggle or Saddleworth.  
L.M.S. Rly.*

*Dobcross,  
Yorkshire, England.*

# Hacking & CO. LTD.

**MAKERS OF LOOMS AND  
PREPARATION MACHINERY**

**MAKERS OF GLEDHILLS PATENT  
AUTOMATIC LET-OFF MOTION.**

*Plain  
Calico  
Loom*

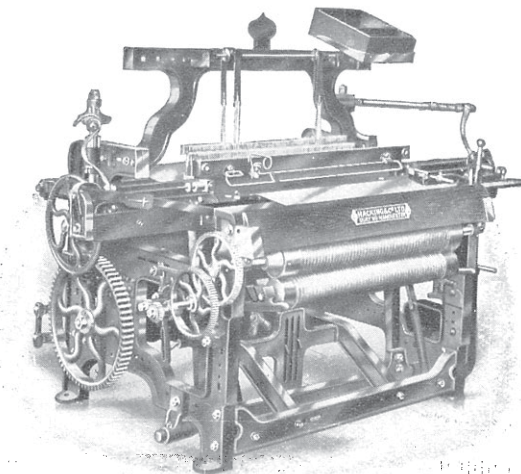

**HACKING & CO. LTD.**  
**BURY, LANCS. : : : : : ENGLAND.**

Codes :  
A B C 5th and 6th Edition, and Bentley's.

Telephone :  
Bury 436 (2 lines).



Telegrams :  
"Whiteley, Huddersfield."

Telephone Nos.  
1397 and 1398.

Codes : A B C 5th Edition, Liebers,  
Bentley's, Western Union.

**MAKERS of MACHINERY**  
**FOR THE**  
**WOOLLEN, WORSTED, CARPET, FELT,**  
**HOSIERY, PLUSH & ARTIFICIAL-SILK TRADES**

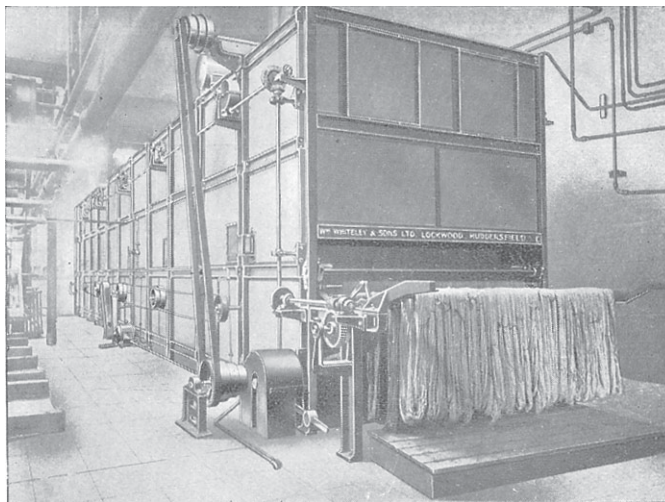

*5-BAY HANK-DRYING MACHINE for Drying all kinds of HANKS*

The machine illustrated is capable of  
drying 12 1500 lbs. of Carpet Yarn  
per hour.

Made any size to suit requirements.

You will be satisfied with output obtained  
in **QUALITY** and **QUANTITY** on this  
machine.

*Dealers in all classes and makes of*

# SECOND-HAND TEXTILE MACHINERY

*for*  
OPENING, PREPARING, SPINNING,  
AND DOUBLING COTTON

CATALOGUE ON APPLICATION

**S. DODD  
& SONS L<sup>T</sup>.D**

LYON WORKS, OLDHAM

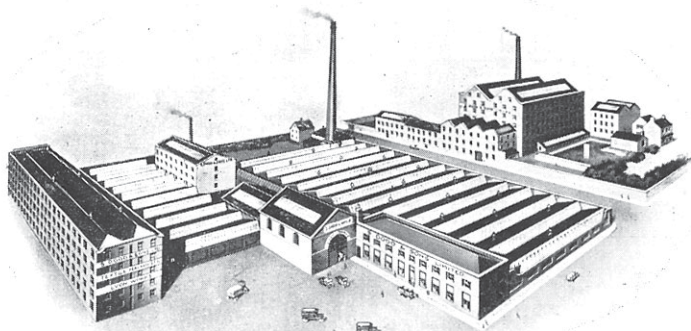

Telephone : 838                      Codes :                      Manchester Exchange  
Telegraphic Address : A B C ; A 1 ;                      Tuesdays and Fridays  
" Dodd, Oldham "                      Bentleys                      Pillar K 2

# The BRADFORD STEAM TRAP

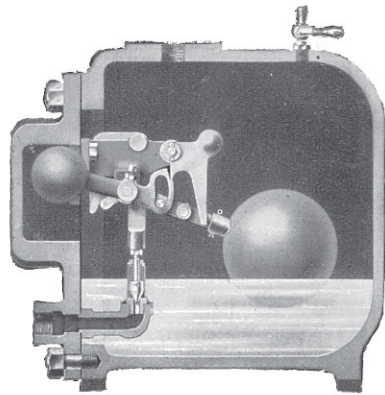

## The LITTLE TRAP with the BIG Discharge:

Simple and positive action.  
Instantaneous opening and closing.  
Discharge full open or dead closed.

### Made in Two Types:

- (a) Piston operated discharge.
- (b) Weight operated discharge.

## The AUTO-GRIND Wheel Valve.

EVERY TIME the valve is opened or closed the renewable Nickel Alloy Valve and Seat are ground to each other. Perfect contact maintained indefinitely.

Length of service prolonged.  
Will outlast several ordinary valves.

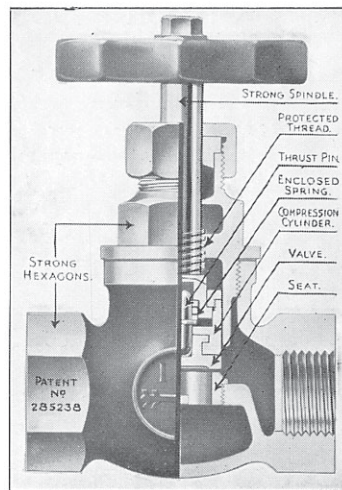

**The United States Metallic Packing Co. Ltd.**  
*Soho Works, Allerton Rd., BRADFORD.*

# *Process Machinery*

## *From the Hank to the Loom*

“Sipp” Hank to Bobbin Winders.

“Benninger” Warping and Beaming Machines.

“Johnson” Sizing Machines.

“Benninger” Looms.

“Staubli” Dobbies.

“Veeder-Root” Loom Pick Counters.

“Nissen” Marking Device.

“Herma” Rolling, Inspecting, Measuring, and Picking Machines.

**FOR SILK & ARTIFICIAL SILKS.**

PRODUCTION — EFFICIENCY — SERVICE

**TEXTILE ACCESSORIES**  
**LIMITED,**  
22, PARSONAGE,  
**MANCHESTER**

# TEXTILE EXPORTER

## AN OVERSEAS TEXTILE JOURNAL

*Publishing and Editorial Offices —*  
**15, LIVERPOOL ROAD, DEANS GATE,**  
**MANCHESTER.**

*Telegraphic Address:—*

**BRENEXJO, MANCHESTER.**

*Telephone:—CENTRAL 98.*

*Proprietors:—THE KENNEDY PRESS LTD.*

*London Representative:—*

**Clifford W. Collinson,**  
**1, Pleydell Court, 55, Fleet Street,**  
**LONDON.**

*Telephone: CENTRAL 2710. Telegrams: "GEOGRAPHO," LONDON.*

Contributions suitable for the editorial pages are invited. These must be of interest to textile readers abroad. Photographs and drawings suitable for reproduction are welcome. Contributions are paid for at the usual rates.

The Journal is devoted exclusively to matters of interest to the textile industries overseas. It circulates among actual buyers of textile machinery and accessories throughout the British Overseas Dominions, Europe, Asia and in the South American Republics. That it may be of equal value to English and non-English speaking textile mill owners and managers all the advertisements are translated into Portuguese, German, and French. The Publishers also offer to translate any article describing a new machine or process when requested by readers abroad.

Single copy, 6d. Post Free, 9d.  
 Annual subscription, post free to any address throughout the world, 9s.

### SPECIMEN CONTENTS.

	PAGE		PAGE
Difficult Conditions . . . . .	19	Shoddy Wool Piece Goods . . . . .	30
World Textile Conditions . . . . .	20	Viscose and Cellulose Acetate Artificial Silks:	
Artificial Silk and the Future . . . . .	20	Which Type Will the Textile Industry	
Detection and Estimation of Damage in		Favour Most? . . . . .	31—32
Cotton Goods . . . . .	21 & 34	Perspiration and Dye Fastness . . . . .	33
Two-Shift System in Art Silk Factories . . . . .	22	Water Tube Boiler Settings: An Interesting	
Textile Design Competition . . . . .	22	Development in Combustion Chamber	
Automatic Cloth Piling Machines . . . . .	23	Setting . . . . .	35
Dutch Cotton Industry . . . . .	23	A "Stream Line" Fire Hydrant . . . . .	36
Getting Rid of Vegetable Matter: or		Latvian Flax . . . . .	36
Essential Carbonising Process . . . . .	25	Organisation and the Wool Industry . . . . .	37
Yarns for Hose and Cloth: The Leanness		Reviews . . . . .	38
of Homespun Yarns . . . . .	27 & 28	Catalogues . . . . .	38
Viscose Processes and Health . . . . .	28	British Trade Notes . . . . .	39—40
New Type Pneumatic Cloth Guider . . . . .	29—30	Some Recent Textile Inventions . . . . .	41—42

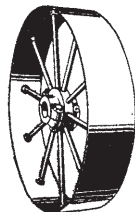

## CROFTS POWER TRANSMISSION APPLIANCES.

SINGLE APPLIANCES OR COMPLETE INSTALLATIONS.

Shafting, Couplings, Bearings, Fixings, Belt and Rope Pulleys, Friction Clutches,  
 Flexible Couplings, Variable Speed Gears, Reduction Units, Complete  
 :: :: :: Gearing Installations. :: :: ::

A range of Catalogues covering All Appliances free on request.

**CROFTS (ENGINEERS) LTD. BRADFORD, ENGLAND.**

Largest Sole Makers of Power Transmitting Machinery under the British Flag.

**GARDNER**  
COLD START

**HEAVY OIL ENGINES**

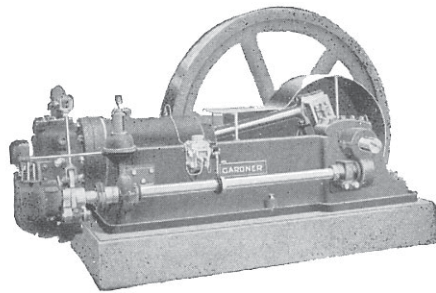

Owing to low speed variation and total absence of vibration these engines provide an ideal source of power for the driving of all classes of

## **TEXTILE & HOSIERY MACHINERY**

They are easy to install and simple to manage.

They start from cold by the mere turning of a small lever.

They generate power at a fuel cost of less than  $\frac{1}{4}$ d. per B.H.P. hour, which is equal to 8 Electrical Units for 3d.

**NORRIS HENTY & GARDNERS, Ltd., PATRICROFT, MANCHESTER**  
(Proprietors : L. Gardner & Sons., Ltd.) London Office : 115, Queen Victoria St., E.C. 4.





## WHY THIS EXHIBITION SOUVENIR ?

Many who receive a copy of this Miniature Edition of THE TEXTILE EXPORTER will remember that a similar Miniature Edition, published last year in connection with the textile machinery exhibition at the City Hall, Manchester, was one of the most successful features of that exhibition, and was a distinct departure from orthodox trade journalism. It was because of the reception that was accorded to the Miniature Edition last year that the publishers of THE TEXTILE EXPORTER decided on another exhibition issue this year of quite a different kind. In textile factories of all kinds there is a daily, one might almost say an hourly, need for a handy size of dictionary of technical terms. There are several comprehensive dictionaries published, but there is an additional need for a concise list of words, giving the exact equivalent in several languages for particular machines and processes of the textile industry.

In addition to a dictionary, there is a frequent need in textile factories for information about rates of exchange and travel times and distances between different foreign cities, hence information of this kind has been included in this souvenir, which will therefore have a distinct permanent value. It can justly be said that this Leicester Exhibition Miniature of THE TEXTILE EXPORTER is complementary to that journal itself, and is in keeping with its policy, because all advertisements in THE TEXTILE EXPORTER are translated into French, German, and Portuguese, and, as pictures have been aptly described as forming an international language, there is no country in the world in which THE TEXTILE EXPORTER is not appreciated and considered to have a real value. It has a sphere of usefulness that is perhaps unique in trade and technical journalism, and it is surely a very modest claim that it is the representative of the British textile machinery and accessories industries overseas.

The circulation of THE TEXTILE EXPORTER is in the colonies, in South America, in the East, and on the Continent of Europe, and

#### TEXTILE EXPORTER

every effort is made to make its pages of interest not only to Britishers overseas, but to foreigners without any knowledge of English. It may aptly be described as the chief missionary of the textile machinery industries of Great Britain. While England has always been, and is likely to remain, the chief textile manufacturing country in the world, overseas countries are developing their textile industries and some of these are keen competitors in the various markets.

An enterprising technical journal can be compared to the industrial exhibition. At the Manchester exhibition last year many new machines were on view, and at the present Leicester exhibition there are a number of knitting and other machines exhibited for the first time, while older types of machine are shown with improvements and modifications. The industrial exhibition, therefore, records progress in design of machinery and in production methods over a considerable period, while the technical journal is a record of progress month by month. Let it be admitted that machinery improvements are not always welcome, because they mean added expenditure, and it is not always easy to prove that they will yield an adequate return. The opinion is sometimes expressed that claims made in regard to labour saving and increased production can be substantiated in progress, but those who will not investigate the claims of new or improved devices would put a period to progress. The rapid development of the artificial silk industry alone has necessitated many modifications of manufacturing and finishing machinery, while the growth in popularity of the new fibre has opened up great opportunities for textile machinists.

As we said in the first issue of this journal, published several years ago, it is sometimes contended that by equipping overseas factories we are simply arming our competitors in our staple industries, but we cannot afford to overlook the fact that, wherever there is a demand for machinery or for other commodities, means will be found to satisfy it. A nation importing large quantities of any kind of goods will seek out means of manufacturing them, and it frequently happens that native production, instead of reducing imports, increases the value of the trade by raising the general standards of comfort throughout the population. THE TEXTILE EXPORTER is not a protagonist of the overseas textile industries, but it recognises that the textile industries of all countries demand the most efficient producing plant, and its purpose is to give information about such plant in its editorial pages.

In conclusion, the publishers would welcome criticism of this Miniature Edition of the journal, and also any suggestions that may be offered whereby future similar editions may become still more useful.

# ENGLISH—FOREIGN DICTIONARY OF TECHNICAL TERMS

English.	French.	German.
A		
Abaca	Abaca	Abaca
Accumulator	Accumulateur	Sammler
Acids	Acides	Sauren
Air heaters	Réchauffeurs d'air	Luft Heizungsapparate
Alternate motion	Va-et-vient	Hin-und hergehende Bewegung
Aloes hemp	Chanvre d'aloès	Aloes Hanf
Alpaca-cloth	Etoffe d'alpaga	Alpaka Tuch
Alpaca hair	Poil d'alpaga	Alpaka
Angle of lead	Angle de calage	Keilwinkel
Artificial silk	Soie artificielle	Kunstseide
Asbestos	Amiante	Asbest
Automatic loom	Métier automatique	Selbsttätiger Webstuhl
B		
Back change wheel	Pignon de marche	Marschwechsel
Back-lever	Axe de pression	Bremsehebel
Back-shaft	Arbre de main douce	Mantausenachse
	Axe de main douce	Hintere Welle
Back-washing	Lissage	Zweite Waschung
Back-wool	Laine-mère	Kernwolle
Bale-breaker	Brise-balles	Ballenbrecher
Ball drag for yarns	Frein à billes de fil	Garnkugelbremse
Balling machines	Machines à pelotonner	Knauelmaschinen
Bar	Verge	Kreuzrute
Batching-oil	Huile d'ensimage	Oel für Wolle
Beam	Ensouple	Baum

TEXTILE EXPORTER DICTIONARY

English.	French.	German.
Beam trucks	Chariots à roulettes pour ensouples	Rollwagen für Bäume
Beam wedges	Coins pour rouleaux- ensouples	Keile für Bäume
Beater	Volant du batteur	Schläger
Beating	Battage	Schlagen
Beating opener	Loup batteur	Klopfwolf
Beaverteen	Molleton	Molton
Beetler	Maillocheuse	Stampfkalander
Belt and strap fastener makers—patent	Fabricants d'attaches pour cuirs et cour- roies (brevetées)	Fabrikanten von Riemenfügen (Patentirt)
Belting	Courroie	Riemen
Bend	Cintre	Bogen
Blades	Lames de métier	Webeblätter
Blanket	Couverture (tissu)	Decke
Bleaching	Blanchiment	Bleichen
Bleaching powder	Chlorure de chaux	Bleichpulver
Blowing-machine	Eplucheuse	Aufbereitmaschine
Bobbin	Bobine, roquet	Spule
Bobbin-bank	Cantre	Scherlatte
Border	Galon	Tresse
Bound muslin	Organdi	Organdy
Bowl	Galet	Leitrolle
Bracket	Support	Träger
Braid	Passementerie	Posamentirware
Breadth	Laize	Zeugbreite
Breaker	Brisoir	Brecher
Breaker card	Briseur à la carde	Brecherkratze
Breaking	Broyage, maquage	Brechen
Broken twill	Satin (armure)	Atlas Köper
Brushing	Brossage	Bürsten
Brussels carpet	Moquette	Brüsseler Teppich
Burling	Epoutissage	Das Noppen
Burling machine	Machine épinceteuse	Noppmaschine
Burring machine	Machine échardonneuse	Klettenwolf

TEXTILE EXPORTER DICTIONARY

English.	French.	German.
C		
Calender	Calandre	Kalender
Calendering	Lustrage	Das Lustrieren
Cam	Came	Kamm
Cam-shaft	Arbre à cames	Daumenwelle
Can-frame	Boudinoir	Flaschenmaschine
Can roving-frame	Métier à lanterne	Flaschenmaschine
Cap	Couvercle	Deckel
Carbonising	Carbonisage, épailage	Carbonisieren
Card	Carde	Kratzen
Card clothing	Garniture de cardes	Kratzenbeschlag
Card grinding	Aiguillage des cardes	Schleifen des Krempel beschlages
Card stripping	Débouillage des cardes	Kardenputzen
Carding	Cardage	Kratzen
Carding roller	Carde à hérissons	Stachelwalze
Carpet	Tapis	Teppich
Carriage	Chariot d'un renvideur	Spindelwagen
Carriage rod	Barre pour chariot	Wagenstange
Catch	Déclit	Sperrklinke
Caustic soda	Soudecaustique	Aetznatron
Celtic weave	Tissu cannelé	Rippengewebe
Chain	Chaîne	Kette
Check	Etoffe à carreaux	Quadrilliertes Zeug
Checked goods	Damier (tissu)	Carrierters Zeug
Chlorinated brine	Saumure chlorée	Chlorierte Sole
Cleaning	Egrenage du coton	Das Entkörnen
Cleaning	Débouillage	Putzen
Clearer	Nettoyeur-frotteur	Putzer
Click	Cliquet	Klinke
Cloth	Etoffe, tissu	Zeug. Stoff
Cloth creaser	Machine à plier le tissu	Wahrenfaltmaschine
Cloth guider	Guide toile	Warenführer
Cloth printing	Impression sur tissu	Zeugdruck
Cloth-prover	Compte-fils	Fadenzähler
Clothing	Etoffe drapée	Tuch
Clouding	Chiné	Chiné
Coarse silk	Bourette	Rohe Seide
Cocoon	Cocon	Cocon
Cold-water spinning frame	Métier à filer à eau froide	Kaltwasserspinnmaschine
Collar	Bague de pression	Stelling

TEXTILE EXPORTER DICTIONARY

English.	French.	German.
Collar	Collet d'une broche	Halslager
Comb blade	Lame de peigne	Kammblatt
Combing	Peignage	Das Kämmen
Compass board	Planche d'arcades	Löcherbrett
Condenser card	Carde fileuse	Vorspinnkrempe
Conditioning	Concitionnement	Konditionierung
Conveyors	Appareils de conduite	Leitungsapparate
Cop	Busette, cannette	Spule
Copper sulphate	Sulfate de cuivre	Schwerfelaurer Kupper
Copping	Envidage	Aufwickeln
Copping-plate	Chariot d'un continu	Bleckbank
Cord	Collet (au Jacquard)	Platinenschnur
Cord-fustian	Velours côtelé	Gestreifter Manchester
Cording	Bref. Empoutage	Bechnüren
Core of cable	Ame d'un câble	Kabelader
Cotton velvets and velveteens	Tissages de velours et velours de coton	Samtwebercien
Counter	Compteur	Zähler
Couper	Bricoteau	Kontermarsch
Cover	Couvercle	Deckel
Crank	Manivelle mécanique	Kurbel
Crank-arm	Bras de manivelle	Kurbelarm
Crank-shaft	Vilebrequin, arbre à manivelle	Kurbelwelle
Crape	Crêpe	Krepp
Creel	Ratelier	Spulengestell
Creeper	App. d'alimentation	Auflege Apparat
Creosote oil	Huile de creosote	Kreosotol
Cretonne	Cretonne	Doppelschirtung
Cropping	Tondre	Scheren
Cross-beam	Entretoise	Omerwelle
Crosshaft	Axe transversal	Querwelle
Cut flax	Lin coupé	Kurzflachs
Cutting-machine	Coupeuse	Schneidemaschine
Cylinder	Tambour	Trommel

TEXTILE EXPORTER DICTIONARY

English.                      French.                      German.

D

Darning	Rentrage	Das Stopfen
Dead wool	Laine morte. Moraines	Pelzwolle
Decorticate (to)	Décortiquer	Entschalen
Designing	Mise en carte	Patronieren
Devil	Diable, loup	Teufel
Diamond	Losange (tissu)	Spitzöppen
Disinfectants	Désinfectants	Desinfektionsmittel
Dobby	Ratière. Mécanique d'armure	Schaftmaschine
Doffer	Peigneur	Streichtrommel
Doffing	Levée de métier	Hubhöhe
Doffing cans	Pots de levée	Abnehmungs-Kannen
Doffing roller	Peigneur	Streichtrommel
Doubler	Réunisseuse	Dublirmaschine
Doubling	Doublage	Verdoppelung
Down	Duvets	Flaumfedern
Down wool	Blousses	Kämmlinge
Drafting	Etirage, laminage	Strecher
Drag motion	App. de tension	Spann Apparat
Draught	Bref	Zettel
Draw	Sortie du chariot	Wagenzug
Draw-box	Boîte d'étirage	Streckwerk
Drawing	Etirage	Strecken
Drawing-frame	Banc d'étirage	Streckenmaschine
Drawing-head	Défeutrer	Entfilzer
Drawing-rollers	Cylindres étireurs	Streckewalzen
Drawing-up-shaft	Axe des scrolls	Einzugswelle
Dress-cloth	Etoffe pour robe	Kleidenstoff
Dressed flax	Lin préparé	Zubereitetes Flachs
Dressing	Encollage. Parage	Schlichten
Drilling machine	Perceuse au Jacquard	Bohrmaschine
Drive (to)	Lancer la navette	Die Schütze durchführen
Driving cord	Corde à broches	Spindelschnur
Driving gear	Commande d'un métier	Getriebe
Driving shaft	Axe de commande	Treibwelle
Drop box slay	Battant brocheur	Broschierlade
Dry frame	Métier à filer au sec	Trockenspinmaschine
Dyeing	Teinture	Färben
Dyers	Teintureries	Färbereien

TEXTILE EXPORTER DICTIONARY

English.	French.	German.
E		
Electricity	Electricité	Elektrizität
Elevators	Ascenseurs	Aufzüge
Embroider (to)	Brocher un tissu	Sticken
Emery filleting	Ruban d'émeri	Schmirgelband
Engine waste	Déchets de coton	Abfall und Putzwälle
Erecting	Montage	Aufstellung
F		
Fabric	Tissu	Zeug
Faller wire	Baguette de métier à filer	Aufwinder
Fan	Ventilateur	Windflügel
Fancy cloth	Etoffe façonnée	Façonierter Stoff
	Etoffe de fantaisie	
Fancy roller	Volant frappeur, volant de la carde	Läufer
Feather shag	Peluche	Felps
Feed table	Chargeuse-table d'alimentation	Einführtisch-Speiser
Feed-water heaters	Réchauffeurs d'eau d'alimentation	Speisewasser Heizungs-apparate
Feeder	Appareil d'alimentation	Auflege Apparat
Feeding rollers	Cylindres alimentaires	Riffelwalzen
Felt	Feutre	Filz
Fine roving	B. à broche en surfin	Doppelfleinfleyer
Finishing	Apprêt	Appretur
Finishing machine	Machine apprêteuse	Appreturmaschine
Fire buckets	Seaux à incendies	Feuereimer
Fishbone	Chevron, tissu	Gebrochener Körper
Flat	Chapeau de carde	Kratzendeckel
Flax	Lin	Flachs
Flax lint	Filasse	Bast
Flax straw	Lin en paille	Rohflachs
Flax tow	Etoupe de lin	Flachshede
Fleecing machine	Machine nappeuse	Vliessmaschine
Floss silk	Filoselle	Florettseide



TEXTILE EXPORTER DICTIONARY

English.	French.	German.
Fluted rollers	Cylindres cannelés	Riffelwalzen
Flyer	Ailette	Flügel
Flyer eye	Curseur de métier à filer	Läufer
Fork	Fourchette	Schussgabel
Frame	Métier en général, bâti d'un métier	Gestellstuhl
Frame end	Bâti extérieur	Endegestell
Friction clutch	Frein à cône	Kegelbremse
Friction plate	Plateau de friction	Friktionplatte
Friction socket	Cône de friction	Friktionskupplung
Frog	Butoir	Stossel
Front lever	Genouillère	Schwinghebel
Fulling mill	Foulon	Walkmühle

G

Gain wheel	Pignon du chariot	Wagenwechsel
Gauge	Calibre	Caliber
Gauze	Gaze	Gaze
Gear wheels	Engrenages	Zahnräder
Gearing end	Tête	Kopfgestell
Gill	Peigne pour lin	Rieth. Hechelfeld
Gill pins	Aiguilles des barrettes	Hechelnadeln
Gin	Egreneuse	Egreniermaschine
Ginning	Egrenage du coton	Das Entkörnen
Glass ring	Bardin	Fadenführer
Glaze	Calandrier	Lustrieren
Glossing	Catissage	Das Pressen
Goods	Etoffes, tissus	Stoffe
Green oil	Huile verte	Grünes Oel
Grinding	Aiguillage	Schleifen
Grinding-machine	Aiguiseuse	Schleifmaschine
Grinding-strap	Cuir à aiguiser	Streichriemen
Groove	Gorge	Spur

TEXTILE EXPORTER DICTIONARY

English.	French.	German.
H		
Hackle bar	Barrette à peignes	Hechelstäbe
Hackle needle	Dent du peigne	Hechelnadel
Hackled hemp	Chanvre peigné	Gehechelter Hanf
Handle	Manivelle à la main	Griff
Harl	Filasse	Bast
Harness	Harnais	Harnisch
Harness board	Equipage	Harnischbrett
Harness cord	Planche d'arcades	Harnischlitze
Head frame	Bâti principal	Grosgestell
Heald	Lisse du Jacquard	Helfe
Healds	Equipage, harnais	Geschirrwerk
Heddle	Lisse	Helfe
Hedding	Remettage	Das Einziehen
Hemming-machine	Machine à ourler	Steppmaschine
Hemp	Chanvre	Hanf
Honey-comb	Nid d'abeille (tissu)	Waffelgewebe
Hooks	Crochets des marches	Tritthaken
Hosiery	Bonneterie	Strumpfwirkerei
Hot water spinning frame	Métier à eau chaude (lin)	Warmwasserspinnmaschine

I

Intermediate frame	B. à broche intermédiaire	Mittelfleyer
--------------------	---------------------------	--------------

J

Jack-frame	Banc à bobines	Spulmaschine
Jack in the box	Croquemitaine	Differentialgetriebe
Jaconet	Jaconas	Jaconas
Jacquard loom	Métier Jacquard	Jacquard-Stuhl
Jacquard needle	Aiguille de Jacquard	Jacquardnadel
Jar	Jarre	Felge

TEXTILE EXPORTER DICTIONARY

English.                      French.                      German.

K

Kicker	Butoir	Stossel
Kneading	Marchage	Treten (Das)
Knitting cotton	Coton à tricoter	Strickgarn
Knitting machine	Machine à tricoter	Strickmaschine
Knocking-off	Déclanchement	Abstellvorrichtung
Knotter	Noueur	Knotenbilder

L

Lace	Dentelle, galon, lacet, tresse	Tresse
Lap (to)	Doubler	Dublieren
Lap rollers	Cylindres enrouleurs pour nappes	Wickelwalze
Lap side	Guide-nappes	Wickellutter
Lathe arm	Epée du battant	Ladearm
Lay	Battant	Lade
Lea	Echevette	Unterband
Lease	Verge, encroix	Kreuz
Lease in warping	Envergure	Tadenkreuz
Lease pin	Cheville d'encroix	Kreuzstift
Lease rod	Baguette d'encroix	Kreuzrute
Let-off motion	Déroulement de la chaîne	Abwickeln
Lever	Levier	Hebel
Lifting bar	Griffes de Jacquard	Hebezeug
Lifting wires	Crochets du Jacquard	Hebehacken
Linen	Lin, toile, linge	Lein. Leinwand
Lining	Doublure (étoffe)	Futterzeug
List	Liseré	Saum
Long narrow wire	Fer (Métiers à velours)	Sammetnadel
Loom	Métier	Webstuhl
Loop	Anneau (Métier à filer, à retordre)	Ringläufer

TEXTILE EXPORTER DICTIONARY

English.	French.	German.
M		
Mails	Mailles d'un tricot	Maschen
Main belt	Courroie de transmission	Treibriemen
Main cylinder	Tambour de carde	Grosse Tromme
Main warp	Chaîne de fond	Grundkette
Mending	Rentrage	Stopfen (Das)
Meshes	Mailles d'un tricot	Maschen
Metallic packing	Garniture métallique	Metalldichtung
Mixture	Mélange	Mischung
Mounting	Harnais, équipement	Harnisch
N		
Nap	Bouton	Noppe
Neck-twines	Arcades	Heber
Needle	Aiguilles	Nadel
Needle stick	Brodeur	Nadelstab eines Nadelstuhls
Net	Tulle	Tüll
Nut	Noix de la broche	Wurtel
O		
Oiling	Ensimage	Das Fetten
Opener	Ouvreuse	Oeffner
Outshoot wool	Abat-chauvée	Ausschusswolle
Oxide of iron	Oxyde de fer	Zinnoxid
P		
Packing needle	Aiguille d'emballage	Packnadel
Paints	Peintures	Farben
Part	Empois	Schlichte
Paste	Fâte	Kitt

TEXTILE EXPORTER DICTIONARY

English.	French.	German.
Pattern chain	Jeu de carton (Jacq.)	Kartenkette
Peel comb	Egrugeoir	Hechel
Pegging	Piquage des cartons (Jacq.)	Kartenschlag
Pick (to)	Lancer la navette	Die Schütze durchführen
Picker	Chasse-navette	Schneller
Picking	Duitage	Schussfolge
Picking arm	Bâton de chasse	Schlagarm
Picking band	Fouet de chasse, cuir de chasse	Webschnellriemen
Picking shaft	Arbre du fouet de chasse	Schlagachse
Picking tappet	Came du fouet	Schlag-excenter
Pile warp	Chaîne de poil	Polkete
Pillow-lace	Dentelle au fuseau	Geklöppelte Spitze
Pin	Goujon	Stift
Pirn	Cannette, busette époule	Spule. Hülse
Pirn winding	Machine canneteuse	Schusspulmaschine
Piston ring	Bague de piston	Kolbenring
Pitch	Ecartement des broches	Teilung
Pitch of rollers	Ecartement des cylindres	Zuglänge
Point-lace	Dentelle à l'aiguille	Genähte spitze
Power	Force	Kraft
Power-loom	Métier à tisser mécanique	Mechanischer Webstuhl
Presser-flyer	Aile d'un b. à br.	Pressflügel
Pressing-card	Carton pour apprêt	Glanzpappe
Pricking machine	Machine à piquer les cartons	Kartenschlagmaschine
Protector rod	Axe du boutoir	Stecherwelle
Pulley	Poulie	Scheibe

Q

Quadrant arm	Bras du secteur	Quadrantarm
Quadrant circle	Secteur du renvideur	Quadrantzirkel
Quilting cloth	Piqué (tissu)	Piqué Tuch

TEXTILE EXPORTER DICTIONARY

English.	French.	German.
R		
Rack	Crémaillère	Zahnstange
Rag-tearing	Effilocheuse	Lumpenwolf
Raised cloth	Etoffe drapée	Tuchartiges gewalktes Zeug
Raw cotton	Coton brut	Rohe Baumwolle
Rayon	Rayon	Rayon
Reading	Lisage	Das Einlesen
Reed	Peigne. Ros	Rieth, Blatt
Reed clutch	Griffes de peigne	Spannhebel
Reel	Asple. Dévidoir	Haspel
Reeling	Dévidage	Das Haspeln
Refined tar	Raffineurs de goudron	Raffinierte Teer
Ret flax	Lin roui	Rösteflachs
Retting	Rouissage	Das Rotten
Reversing motion	Mouvement à bascule	Umdrehungsbewegung
Revolving box loom	Métier revolver	Revolverstuhl
Revolving flat	Carde à chapeaux tournants	Deckelkratze
Ribbon	Ruban	Band
Ring	Bride	Spange
Ring-rail	Platebande des an- neaux	Ringschiene
Ring-spindle	Broche à anneaux	Ringspindel
Ring twisting frame	Métier à retordre à anneaux	Ringzwirnmachine
Roller	Cylindres	Walze
	Galet	Leitrolle
Roller and clearer card	Carde à hérissons	Walzenkrempe
Rope	Corde	Seil
Rover-rod	Barre à mèches	Vorgespinnstange
Roving frame	Banc à broche en fin	Feinfleyer
Row (to)	Lainer	Rauhen

S

Sample cord	Corde de sample	Zampelschnur
Satin top	Futaine	Atlas Barchent
Scouring	Dessuintage	Entfettung

TEXTILE EXPORTER DICTIONARY

English.	French.	German.
Scouring of silk	Décreusage	Entschieren der seide
Scratch (to)	Détisser	Zerreissen
Screw thread	Filet	Schraubengewinde
Scribbling machine	Briseuse de lame	Schrubbelmaschine
Scutch (to)	Battre le coton	Klopfen
Scutcher	Volant du batteur	Schläger
Scutcher opener	Batteur étaleur	Wattenmaschine
Scutching	Broyage	Brechen
Self-acting mule	Métier à filet renvideur	Selfactor
Self-acting stripper	Déboureur mécanique	Selbsttätiges Deckelputz- Apparat
Self-acting twiner	Métier à retordre ren- videur	Selfactorzum Zwirnen
Selvage	Lisière	Egge
Separator comb	Peigne de carde	Scheidekamm
Set	Assortiment	Auswahl
Setting-up motion	Régulateur d'ensouple du tissu	Das Aufbäumen
Sewing cotton	Coton à coudre	Nähgarn
Sewing-machine	Machine à coudre	Nähmaschine
Sewing thread	Fil à coudre	Nähgarn
Shaggy	Etoffe grossière	Kotzen
Shearing-machine	Tondeuse	Scheermaschine
Shed	Foule. Pas	Sprung
Shoddy wool	Laine artificielle, laine renaissance	Lumpenwolle
Shoot (to)	Lancer une duite	Einschiessen
Shooting	Duitage	Schussfolge
Shot counter	Compteur de duites	Schusszähler
Shrinkage	Embuvage	Das Einweben
Shuttle	Navette	Schütze
Shuttle box	Boîtes à navettes	Schützenkasten
Shuttling	Lançage de la navette	Das Schlagen
Side-gabel	Bâti de côté	Seitenstuhl
Side-rail	Garde-corps	Brücken geländer
Silk-throwing	Moulinage	Das Moulinieren
Silk-throwing	Machine, moulin à soie	Sedenzwirmmaschine
Silk-waste	Schappe. Déchets de soie	Seidenabfall
Silk worm house	Magnanerie	Rauperei
Singeing	Flambage, grillage	Sengen
Sinkers bars	Barre à platines	Platinenbar
Size	Colle. Empois	Schlichte
Size-box	Bac à colle	Schlichtetrog

TEXTILE EXPORTER DICTIONARY

English.	French.	German.
Sizing	Encollage	Schlichten
Sizing machine	Encolleuse	Stärkemaschine
Skein	Echeveau, échevette	Strahne
Skin-wool	Laine d'écouailles	Hautwolle
Slack	Fil lâche	Schlaff
Slay	Battant	Lade
Slide	Glissière	Gleitstück
Sliver	Mèche, boudin	Lunte
Sliver can	Pot d'étirage	Topf
Sliver guide	Guide-mèche	Bandführöfeln
Slub. sliver	Mèche, boudin	Lunte
Slubbing-frame	B. à broche en gros	Grobflayer
Spinning	Filage	Spinnerei
Spinning-mill	Filature	Spinnerei
Spinster	Fileuse (soie)	Seidenhasplerin
Spool	Epoule, bobine	Spule
Spreader	Etaleuse pour lin	Anlegemaschine
Spreading flax	Etendage du lin	Spreiten des Flachses
Spun fiolet silk	Fil de schappe	Schappegarn
Stand	Montant, support	Stütze, Träger
Steam traps	Séparateur d'eau de condensation	Kondenswasserabschneider
Step	Coussinet	Lagerschale
Step bearing	Crapaudine	Fusslager
Stocking	Bas	Strumpf
Stop motion	Mouvement d'arrêt	Abschlagsbewegung
Stop-motion. weft	Casse-mèche	Abstellvorrichtung
Stretch	Aiguillée	Auszug
Stretcher	Lisière	Leiste
Stuff	Etoffe, tissu	Stoffe
Stuff grinder	Défribreur	Zerfaserungsmaschine
Sulphuric acid	Acide sulphurique	Schwefelsaure
Sulphate of ammonia	Sulfate d'ammoniaque	Ammoniumsulfate
Sut	Echevette	Unterband
Swingle-dag	Ecang	Schwinge
Swinging	Espadage du lin	Das Schwingen
Swinging	Teillage du lin	Schwingeln
Swing stock	Chevalet à lin	Schwingstock
Swivel-shuttle	Espolin	Broschierschiffchen



TEXTILE EXPORTER DICTIONARY

English.	French.	German.
T		
Table-linen	Linge de table	Tischleinen
Tacking up	Enroulement du tissu	Aufwicklung
Tappet	Excentrique	Excenter
Teazling	Lainage	Das Rauhen
Teazling-machine	Laineuse	Rauhmaschine
Temple	Templet	Sperrute
Tentering-machine	Rameuse	Rahmenmaschine
Thread	Fil	Faden
Thread-mill	Filterie	Leinenzwirnspinnerei
Thread-plate	Guide-fil	Fädenführer
Throstle	Continu à filer	Ringspinnmaschine
Throstle frame	Métier continu	Drosselmaschine
Throwsilk	Organsin	Organsinseide
Tick	Coutil	Barchent
Top rollers	Cylindres de pression	Druckwalzen
Transmission	Transmission	Uebertragung
Treading	Foule, pas	Fach
Treading-tappet	Excentrique	Excenter
Treadle	Pédale	Fusstritt
Treadle	Marche d'un métier à la main	Tritt
Tweel. Twill	Etoffe croisée	Köper
Tweel	Finette	Fine Wolle
Twill	Croisé. Sergé	Köper
Twilld cloth	Etoffe (croisé)	Köper.—Geköperte Stoffe
Twine	Liage	Bindung
Twined	Càblé	Gedreht
Twist	Torsion	Drehung
Twist wheel	Pignon de torsion	Zwirnwechsel
Twisted	Retors, càblé	Gedreht
Twisted yarn	Fils retors	Gezwirntes Garn
Tying up	Armure dessin	Schnürung

TEXTILE EXPORTER DICTIONARY

English.	French.	German.
U		
Underfaller	Contrebaguette	Gegenwender
Undyed wool	Laine beige	Naturfarbenwolle
Upright loom	Métier haute lisse	Hautelisse Stuhl
Upright shaft	Axe vertical	Senkrechte Welle
V		
Valve	Soupape	Ventil
Velvet	Velours	Sammet
Ventilating	Ventilation	Lüftung
W		
Warp	Chaîne ourdie	Kette
Warp cop	Fuseau, bobine	Spule
Warp frame	Ourdissoir	Scherrahmen
Warp thread	Fil de chaîne	Kettengarn
Warping	Ourdissage	Das Kettenscheren
Washing	Lavage	Das Waschen
Washing	Dégorgeage des draps	Das Auswachsen
Washing-machine	Leviathan	Leviathan
Washing out	Décatissage	Das Dekatieren
Watered	Moiré	Mohr
Weft	Trame	Schuss
Weft stop-motion	Casse-trame	Schusswächter
Weighing-machine	Bascule	Brückenwage
Wet spinning-frame	Métier à filer au mouillé (lin)	Nassspinnmaschine
Wharve	Noix de broche	Würtel
Wheel	Pignon	Getriebe
Willowing	Louvetage	Wolfen
Winding-frame	Bobinoir	Spulmaschine
Winding-on chain	Chaîne du secteur	Quadrantenkette
Winding-on drum	Barillet	Kettentrommel
Winding-up	Envidage, renvidage	Das Aufwickeln
Wipper shaft	Arbre des excentriques	Excenter Welle
Wool-burring	Echardonnage	Entketten

TEXTILE EXPORTER DICTIONARY

English.	French.	German.
Wool-scouring	Degraissage (laine)	Entfetten
Wool yarn	Fil de laine	Wollgarn
Woollen cloth	Drap (tissu)	Laken
Woollen goods	Etoffe de laine cardée	Streichgarngewebe
Worsted goods	Etoffe de laine peignée	Kammgarngewebe
	Y	
Yarn	Fil	Faden
Yarn-scouring	Lavage des filés	Garnwäscherei
Yarn-testing	Conditionnement	Conditionieranstalt
	Z	
Zephyr cloth	Zéphyr (tissu)	Zephire Tuch

## FOREIGN MONEY QUOTATIONS.

(Subject to Slight Fluctuations.)

<b>Albania</b> .. Notes, per F. 100	£3 17 0	<b>Colombia</b> .. Notes marked	
<b>Algeria</b> .. Notes, per F. 100	15/11	" Oro " Gold ..	3/9
<b>Argentina</b> .. Notes, Peso .....	1/8½	<b>Curacao</b> .. Notes, Fl. 100...	£7 15 0
Gold, Argentino..	19/6	<b>Cyprus</b> .. Notes, per £1 ...	19/8
Silver, old Peso..	1/4	<b>C. Slovakia</b> Notes, Kn. 100 ..	12/-
<b>Australia</b> .. Notes, £1 .....	19/7	<b>Danzig</b> .. Notes, Fl. 100 ..	£3 18 6
Silver Shilling ...	11d.	<b>Denmark</b> .. Notes, Kr. 100..	£5 9 0
<b>Austria</b> .. Notes, S. 100 ..	£2 17 6	Silver, Kr. 1 .....	1/0¼d.
Gold, Kn. 20 old	16/-	<b>Egypt</b> .. Notes.....	£1 0 5
Gold, S. 100 new	£2 16 9	Gold .....	£1 0 0
Silver, old Kn. 1	3d.	Silver, 100 piastres .....	18/3
Silver, new		Nickel, 100 piastres .....	17/-
Schilling .....	6d.	<b>Ecuador</b> .. Notes, 1 Sucre ..	8d.
<b>Bahamas</b> .. Notes.....	19/3	<b>Estonia</b> .. Notes, New	
<b>Barbados</b> .. Notes, \$5 .....	19/9	Kroon .....	1/-
<b>Belgium</b> .. Notes, F. 100 ...	11/4	<b>Falkland</b> .. Notes, £1 .....	18/6
Gold, F. 20 .....	15/8	<b>Fiji</b> .. Notes, £1 .....	19/-
Silver, old F. 1..	3d.	<b>Finland</b> .. Notes, Markka	
Nickel, F. 1.....	1¼d.	100.....	10/3½
<b>Belge Congo</b> Notes, F. 100....	11/-	<b>France</b> .. Notes, F. 100..	16/-16/0½
<b>Bermuda</b> .. Notes.....	19/3	Gold, F. 20 ...	15/8
<b>Bolivia</b> .. Notes, Boliviana	1/3	Silver, F. 1 .....	3d.
<b>Brazil</b> .. Notes, Milreis ..	5½d.	Nickel .....	1¾d.
<b>B.E. Africa</b> Notes, £1 .....	19/6	<b>Germany</b> .. Renten and new	
<b>B.W. Africa</b> Notes, £1 .....	19/6	Reichsmarks	
Silver and Alum.		Notes, 100.....	£4 17 9
Bronze .....	11d.	Gold, M. 20 .....	19/4
<b>Bulgaria</b> .. Leva, 100 .....	2/8	Silver, new M. 1..	11d.
<b>Canada</b> .. Notes, \$1 .....	4/0¾	Silver, old M. 1..	3d.
Gold, \$1 .....	4/0¾	<b>Gibraltar</b> .. Notes, £1 .....	19/8
Silver, \$1 .....	3/11	<b>Greece</b> .. Notes, Dr. 100 ..	5/1
<b>Chili</b> .. Notes, Peso .....	5½d.		
Gold, 1926 .....	5¾d.		

## FOREIGN MONEY QUOTATIONS.

(Subject to Slight Fluctuations.)

<b>Guatemala</b>	Notes, Quetzal ..	3/7	<b>Philippine</b> ..	Notes.....	1/11
<b>Guernsey</b> ..	Notes, £1 .....	19/9	<b>Poland</b> ..	Notes, Zloty ...	5½d.
<b>Holland</b> ..	Notes, Fl. 100... £8 4 6		<b>Portugal</b> ..	Notes, Escudo ..	2½d.
	Gold, Fl. 10 ....	16¼		Colonial Notes...	1d.
	Silver, Fl. 1.....	1/7¼	<b>Roumania</b>	Notes, Lei 100 ..	2/4
<b>Hong Kong</b>	Notes, \$1 .....	1/10½	<b>Russia</b> ..	Notes, not buyers	
<b>Hungary</b>	Notes, P. 100 ...	£3 11 4		Gold .....	2/-
<b>Iceland</b> ..	Notes, Kr. 100... £4 7 0		<b>Scotland</b> ..	Notes, £1 .....	19/11½
<b>India</b> ..	Notes, Rupee 1..	1/5¾	<b>Senegal</b> ..	Notes, F. 100 ...	15/-
	Silver.....	1/4½	<b>Serbia</b> ..	Notes, Dinar 100	7/-
<b>Ireland</b> ..	Notes.....	19/11½	<b>Shanghai</b> ..	Notes, \$1 .....	1/7
	Silver.....	19/3	<b>Siam</b> ..	Notes, tical .....	1/9
<b>Italy</b> ..	Notes, L. 100 ...	£1 1 5	<b>S. Africa</b> ..	Notes, £1 .....	19/9
	Silver, new.....	2¼d.		Gold, £1 .....	19/6
	Nickel & Copper,			Silver Shilling ...	11d.
	L. 1 .....	2d.	<b>Spain</b> ..	Notes, P. 100 ..	£2 19 0
<b>Jamaica</b> ..	Notes, £1 .....	19/6		Silver.....	6d.
<b>Japan</b> ..	Notes, Yen 1 ...	1/10	<b>Straits</b> ..	Notes, \$1 .....	2/3¼
	Gold, Yen 10 ..	19/6	<b>Sweden</b> ..	Notes, Kr. 100 ..	£5 9 6
<b>Java</b> ..	Notes, Fl. 100... £8 2 6			Silver.....	1/-
<b>Latvia</b> ..	Notes, Lat. 1 ..	9d.	<b>Swiss</b> ..	Notes, F. 100 ..	£3 19 0
<b>Lithuania</b> ..	Notes, Litas 100..	£1 19 0		Gold, F. 20 .....	15/8
<b>Luxemburg</b>	Notes, F. 100 ...	11/-		Silver.....	9d.
<b>Mauritius</b> ..	Notes, Rupee ..	1/3	<b>Syria</b> ..	Notes, Piastre 100	3/-
<b>Mexico</b> ..	Gold, Peso .....	2/-	<b>Tunis</b> ..	Notes, F. 100 ..	15/10
	Silver, old large..	1/4	<b>Turkey</b> ..	Notes, £1 .....	1/11
<b>Morocco</b> ..	Notes, F. 100 ...	15/7		Silver, 20 Piastres	1/4
<b>N. Zealand</b>	Notes, £1 .....	19/7		Gold .....	17/6
<b>Norway</b> ..	Notes, Kr. 100 ..	£5 9 3	<b>U.S. America</b>	Notes, \$1 .....	4/1½
	Silver.....	1/-		Silver.....	3/11
<b>Palestine</b> ..	Notes, £Pl. ....	19/9		Gold .....	4/0¾
	Silver, Mils 10 ..	2½d.	<b>Uruguay</b> ..	Notes.....	3/10
<b>Peru</b> ..	Notes, Libra ....	15/6	<b>Venezuela</b> ..	Notes, 1 Boliva	8½d.
	Gold, Libra .....	19/6			

TEXTILE EXPORTER

Distance and Approximate Time of Travel by Sea and Rail.

To	From	Miles.	Time in Days.
Adelaide	London	11,100	36
Alexandria	"	2,275	6
Algiers	"	1,239	3
Athens	"	1,890	6
Berlin	"	729	21 hrs.
Bombay	"	5,439	16
Boston	Liverpool	2,932	8
Brisbane	London	12,314	44
Buenos Ayres	Southampton	6,126	22
Cairo	London	2,507	7
Calcutta	"	6,493	19
Cape Town	Southampton	6,010	20
Chicago	Liverpool	4,082	8
Colombo	London	5,868	17
Constantinople	"	1,820	3
Copenhagen	"	780	25 hrs.
Delagoa Bay	Southampton	6,917	29
Gibraltar	London	1,299	5
Halifax	Liverpool	2,415	7
Hobart	London	11,951	41
Hong-Kong	"	9,799	34
Iceland	Leith	1,050	5
Jamaica	Southampton	4,702	22
Lisbon	London	1,450	50 hrs.
Madeira	"	1,300	4
Madrid	"	1,940	40 hrs.
Malta	"	2,280	7
Melbourne	"	10,750	32
Mexico	Liverpool	5,447	14
Montreal	"	2,850	7
Natal	Southampton	6,628	22
New Orleans	Liverpool	4,615	14
New York	"	3,170	6
Panama	"	8,860	19
Rangoon	"	7,955	31
Rio de Janeiro	"	5,156	19
Rome	London	1,232	39 hrs.
San Francisco	Liverpool	6,397	12
Leningrad	London	1,750	55 hrs.
Shanghai	"	10,540	38
Singapore	"	7,527	23
Suez	"	2,419	7
Sydney	"	10,296	34
Vancouver	Liverpool	5,584	13
Wellington	London	13,345	47
Yokohama	Liverpool	10,452	32
Zanzibar	London	4,745	20

TEXTILE EXPORTER.

Distance and Approximate Time of Travel by Air, Rail and Sea.

To	From	Air Route via	Time in days (unless otherwise stated).		
			Rail, Sea.	Air.	Saved.
Adelaide	London	I.A.L., Karachi, and West Australian Airways.	31	27	4
Alexandria	"	I.A.L.	4½	4½	—
Algiers	"	A.U., Marseilles, and Aeropostale.	2½	1½	1
Athens	"	I.A.L.	84 hrs	54 hrs	30 hrs
Berlin	"	D.L.H.	20½	9½	11
Bombay	"	I.A.L.	14½	10	4½
Boston	"	—	No saving by air.		
Brisbane	"	I.A.L., and West Australian Airways	40	38	2
Buenos Ayres	"	Aeropostale and boat	23	10	13
Cairo	"	As for Alexandria	Plus 3½ hrs. in each case.		
Calcutta	"	I.A.L. and rail	16½	10½	6
Cape Town	"	—	19	No saving of time.	
Chicago	New York	Rail and Universal	—	—	—
Colombo	London	I.A.L. to Karachi and boat or rail.	18	16	2
Constantinople	"	Paris, Bucharest	80 hrs.	50 hrs.	30 hrs.
Copenhagen	"	Amsterdam	33	9½	23½
Delagoa Bay	"	Air Mail from Cape Town, Durban.	Saves 1-2 days.		
Gibraltar	"	By air to Madrid and train.	64 hrs.	54 hrs.	10 hrs.
Halifax	"	—	No saving of time.		
Hobart	"	—	Gain of 3 days by Australian Air Services.		
Hong Kong	"	I.A.L. Karachi-Colombo	Only one day yet.		
Iceland	London	—	No saving of time		
Jamaica	"	—	No information.		
Lisbon	"	—	No saving of time.		
Madaira	"	—	"		
Madrid	"	Biarritz and night train	34 hrs.	24 hrs.	10 hrs.
Malta	"	Naples, train and boat	85	62	23
Melbourne	"	I.A.L., Karachi, and Colombo, and Australian Airlines.	33	28	5

Distance and Approximate Time of Travel by Air, Rail and Sea.—continued.

To	From	Air Route via	Time in days (unless otherwise stated).
Mexico .....	New York .....		Rail, Sea. 4½ .. Air. 3 .. Saved. 1½
Montreal .....	London .....	Rail, Universal Aviation, and Southern Air Transport.	No saving of time yet.
Natal .....	" .....	" .....	" ..
New Orleans .....	" .....	" .....	No information.
New York .....	" .....	" .....	No saving of time yet.
Panama .....	" .....	" .....	" ..
Rangoon .....	" .....	I.A.L., Karachi, Colombo .....	One day saved at present.
Rio de Janeiro .....	" .....	Aeropostale .....	18 .. 9 .. 9
Rome .....	" .....	" .....	35 hrs. .. 28 hrs. .. 7 hrs.
San Francisco .....	New York .....	Transcontinental Air Transport Inc.	4 .. 3 .. 1
Leningrad .....	London .....	" .....	3½ .. 1½ .. 2
Shanghai .....	" .....	I.A.L., Karachi, Colombo .....	One day at present.
Singapore .....	" .....	I.A.L., Karachi, Colombo .....	" ..
Suez .....	" .....	I.A.L., Karachi, Colombo .....	No saving of time yet.
Sydney .....	" .....	I.A.L., boat, and Australian Airways	36 .. 32 .. 4
Wellington .....	London .....	" .....	No saving of time yet.
Yokohama .....	" .....	I.A.L., Karachi, Colombo .....	One day saved at present.
Zanzibar .....	" .....	" .....	No saving of time yet.

When the new Imperial Airways route to Australia is opened, the following times of transit from London will be possible:—

Adelaide .....	19 days—saving 12 days over boat.
Bombay .....	9 " " 5½ " "
Brisbane .....	18 " " 22 " "
Calcutta .....	9 " " 5½ " "
Melbourne .....	20 " " 13 " "
Rangoon .....	10 " " 8 " "
Singapore .....	12 " " 12 " "
Sydney .....	21 " " 15 " "
Wellington .....	A saving of about 15 days.



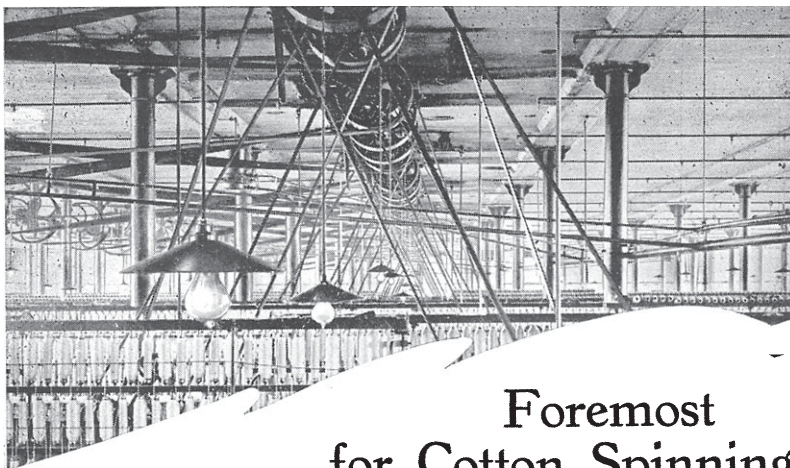

Foremost  
for Cotton Spinning  
since 1873. ∞ ∞ ∞

## CAMEL HAIR BELTING

THE constant unvarying speed assured by the use of CAMEL HAIR BELTING results in extreme uniformity of yarn spun. The additional power transmitted increases production, and the extra length of service it gives reduces the Belting expenditure considerably.



*Inventors & Sole Makers:*

**F. REDDAWAY & Co. LTD.**

PENDLETON, MANCHESTER,  
& BUSH HOUSE :: :: LONDON, W.C.2.

**REDDAWAY  
PRODUCTS**

*for the*  
TEXTILE INDUSTRY

Canvas Fire Hose

Printing and Washing  
Pads for  
Calico Printers.

Rubber-Covered  
Rollers for  
Bleachers, Dyers

Mechanical Rubber  
Goods

TEXTILE EXPORTER.

Codes: 0th. A [C. Lieber & Marconi and Bentley's "Grams." Hattersley, Keighley." Phone: Keighly 2275 (Priv. Branch Exchange).

## LOOMS FOR ALL FABRICS

Makers of the first Power Loom for the  
Worsted Industry 1834. Established 1789.  
Original Inventors and Makers of the Dobby, 1867.

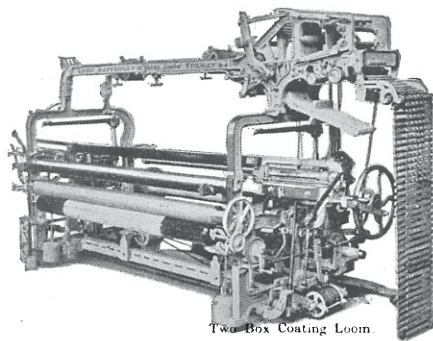

Two-Box Coating Loom.

UNIVERSAL CHEESE, CONE, AND  
WEFT WINDING MACHINES,  
WARPING, BEAMING AND  
MAKING UP MACHINES.

Gold Medals and Highest Awards at all the  
Leading Expositions during the last 60 years.

# Hattersley Looms

GEORGE HATTERSLEY & SONS, LTD.,  
YORKSHIRE KEIGHLEY ENGLAND.

# **British Northrop Looms**

are the best built  
and the most simple  
Automatic Looms  
on the market, and  
therefore :—

1. There are more Northrop Automatic Looms in the world than any other make or type.
2. One operative can look after 24, 28, or 32 looms.
3. Initial outlay and cost of upkeep are the lowest.
4. Greatest reliability.

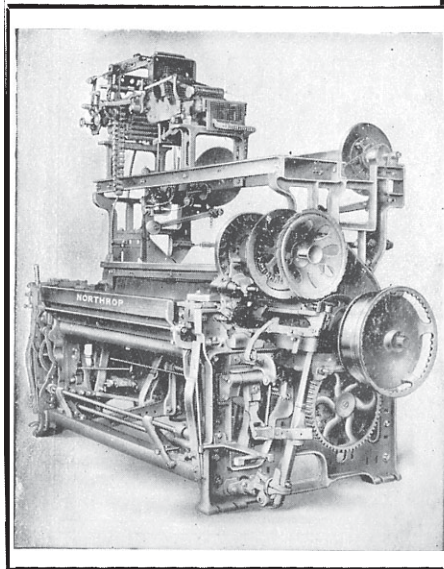
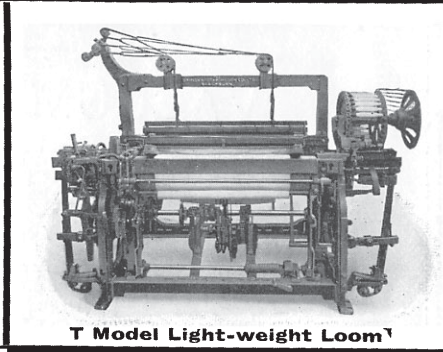
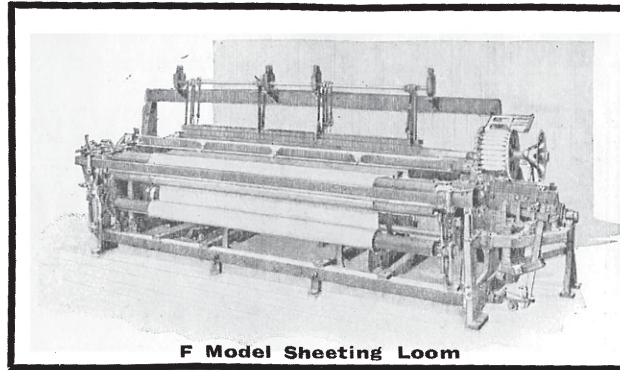

**THE  
BRITISH NORTHROP  
LOOM CO. LTD.,  
BLACKBURN**

builds a larger variety  
of Automatic Looms  
than any other loom  
maker.

Light, medium, and  
heavy-weight looms,  
in all widths, are  
specially designed for  
different qualities of  
cloth.

**HARGREAVES'**  
**CARD ROOM**  
**EQUIPMENT**

Gives increased production, together with  
better conditions for the operatives.

---

VACUUM PLANTS  
FOR  
CARD STRIPPING  
AND  
CLEANING  
THROUGHOUT THE MILL.

---

VENTILATING  
FANS OR COMPLETE PLANTS  
FOR  
VENTILATION AND DUST  
REMOVAL.

---

*Send us your enquiries.*

**GEORGE HARGREAVES & SONS Ltd.**  
**BROOKHOUSE LANE,**  
**BLACKBURN.**

Phone 5654.

# WHY WASTE COAL?

PUT A LEA RECORDER IN CHARGE  
OF YOUR BOILERS,

and you will then  
know what they  
are doing,  
and what they  
are NOT doing.

Diagrammatic Sketch  
showing method  
of measuring  
Boiler Feed Water.

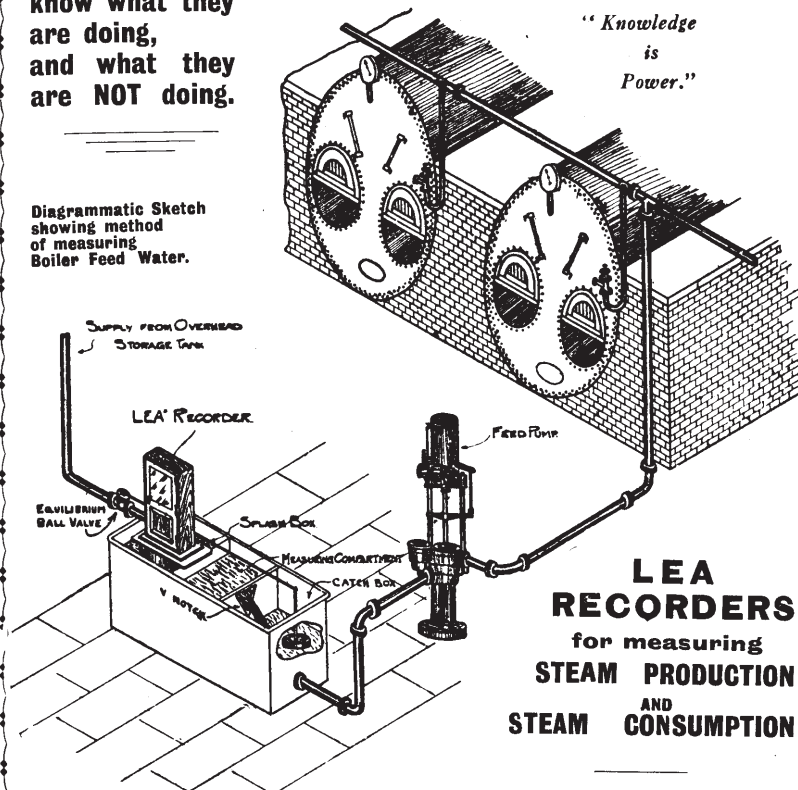

For Latest Particulars, write to:—  
**THE LEA RECORDER CO., LTD.,**  
28, Deansgate, Manchester.

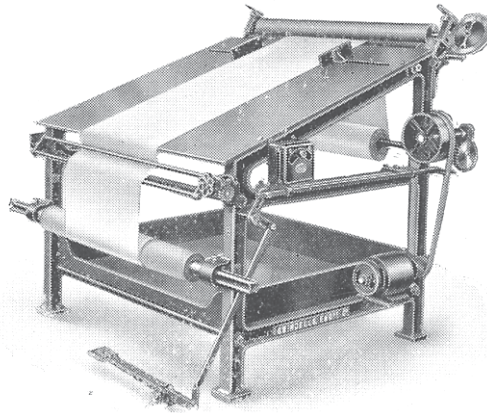

Cloth Inspecting  
Machine.

DYEING AND FINISHING SILK, ART.  
SILK AND MIXED FABRICS, BATCHING,  
SPRAY DAMPING, PADDING MANGLES,  
NATURAL LUSTREING, BLANKET  
FINISHING, STENTERS, CALENDERS,  
SUCTION DRYERS, SPECIAL HANK  
AND PIECE DYEING MACHINES,  
FESTOON DRYING MACHINES, EX-  
PANDERS, PALMER MACHINES, Etc.

**SWINDELLS**  
**ENGINEERING CO.**

Telephone :  
N<sup>o</sup> 0588

Telegrams :  
"SECO"

MACCLESFIELD

ERNEST  
**SCRAGG**  
**& SONS LIMITED.**

*Manufacturers of*  
**NETT & ARTIFICIAL SILK  
MACHINERY**

**W**E specialise in the manufacture of high-class Machinery for Throwing and Preparing of Ordinary and Grant or Cross-reeled Skeins.

Our Machinery for Artificial Silk is the outcome of constant study, and gives the maximum output with the minimum wear.

**Hard Silk Winders  
Soft Silk Winders  
Artificial Silk Winders  
Cleaning Machines  
Doubling Machines  
Spinning Machines  
Throwing Machines  
Reeling Machines  
Combined Machines  
Etc., Etc.**

**Accessories of all descriptions for all makes  
of machines.**

**Mill furnishers. Works completely equipped.**

Telephone 3016 P.B.

**MACCLESFIELD ENGLAND**

---

**HELE - SHAW  
REVERSING GEARS**

**Robust &  
Reliable**

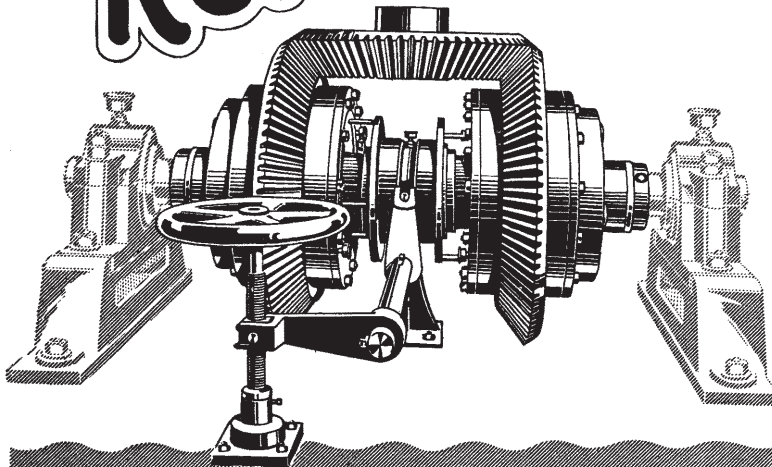

---

**THE BRITISH HELE-SHAW  
PATENT CLUTCH CO., LTD.  
OLDHAM ENGLAND.**

---



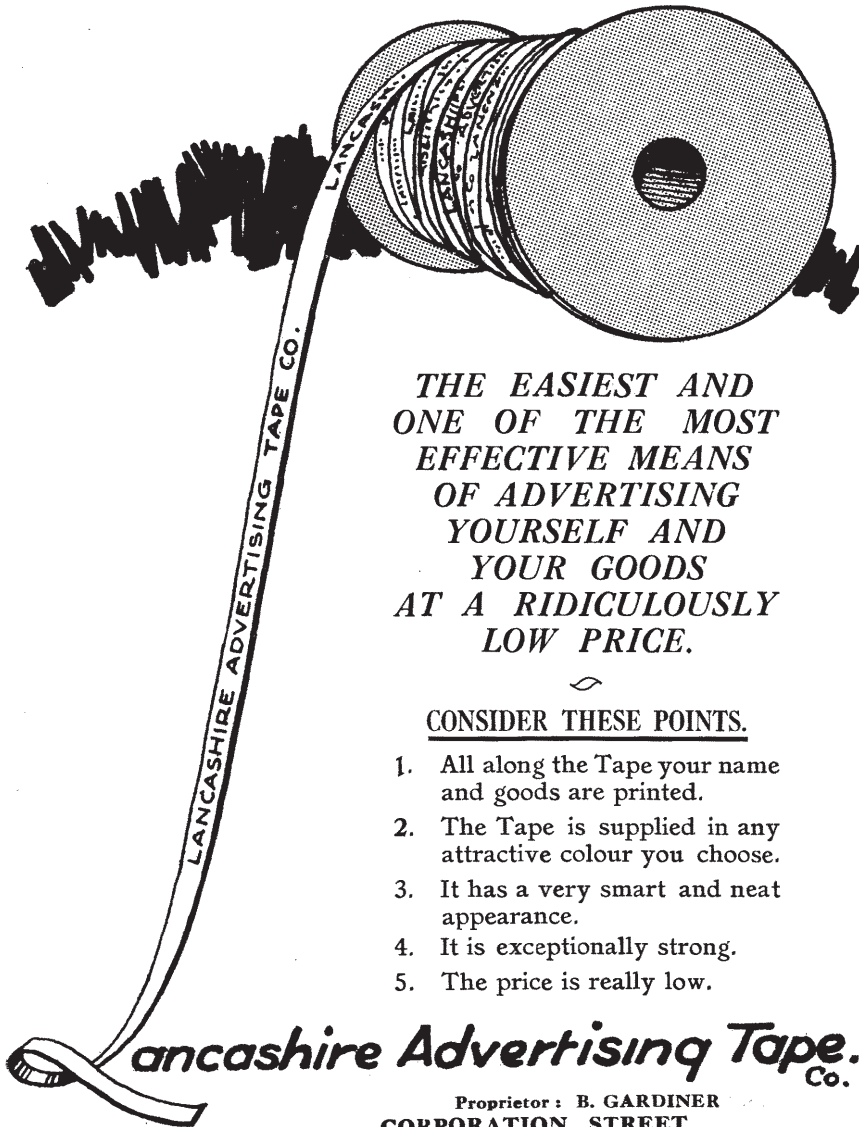

*THE EASIEST AND  
ONE OF THE MOST  
EFFECTIVE MEANS  
OF ADVERTISING  
YOURSELF AND  
YOUR GOODS  
AT A RIDICULOUSLY  
LOW PRICE.*



CONSIDER THESE POINTS.

1. All along the Tape your name and goods are printed.
2. The Tape is supplied in any attractive colour you choose.
3. It has a very smart and neat appearance.
4. It is exceptionally strong.
5. The price is really low.

*Lancashire Advertising Tape.*  
Co.

Proprietor: B. GARDNER  
CORPORATION STREET,  
MIDDLETON, MANCHESTER

The MANIPULATION of  
**ARTIFICIAL SILK**

in yarn or fabric  
is  
**SIMPLIFIED**  
by  
using our machinery

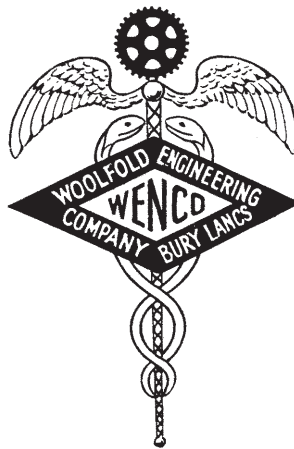

**WOOLFOLD ENGINEERING Co.**

Telegrams :  
WENCO BURY

**BURY**

Telephone :  
Bury 81

---

---

## *All Belts are as strong as their Lacings.*

If the lacings are "KLINCHA" you can be sure you are using the strongest.

"KLINCHA" Belt Lacings for all types of Belts and all types of service.

*It is economical to use "KLINCHA."*

We shall be pleased to send you a Machine and Fasteners for 30 days' free trial in your works.

Various types of Machines made to suit all users of belting.

Improved "KLINCHA"  
BELT LACING FASTENERS  
Made in 12 in lengths.

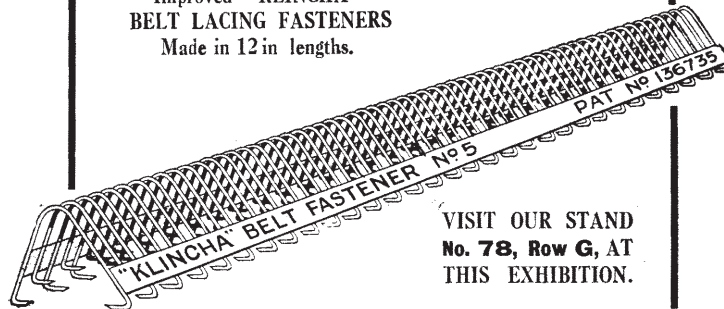

VISIT OUR STAND  
No. 78, Row G, AT  
THIS EXHIBITION.

**W. T. NICHOLSON & CLIPPER**  
COMPANY LIMITED,  
**CLIPPER WORKS, SALFORD,**  
MANCHESTER.

---

---

---

---

## *Here's your Overseas Representative*



Display your manufactures in the

“TEXTILE  
EXPORTER.”

The Journal that *Concentrates* on overseas trade. Its Advertisements are printed in four universally used languages—English, French, German, and Portuguese. It is a bright and cheerful representative.

---

*SPECIMEN COPY FREE ON REQUEST*

---

*The*  
“TEXTILE EXPORTER”  
15, LIVERPOOL ROAD, DEANSGATE,  
MANCHESTER.

---

---

TEXTILE EXPORTER

# PLATT BROTHERS & Co. Ltd.

For 100 Years Makers of MACHINERY for GINNING COTTON, OPENING, CARDING, COMBING, PREPARING, SPINNING, DOUBLING and WEAVING COTTON, WOOL, WORSTED, WASTE, and SILK WASTE. Also Makers of MACHINERY for OPENING, CARDING and SPINNING ASBESTOS, ARTIFICIAL SILK STAPLE FIBRES, "FIBRO," "VISTRA," Etc.

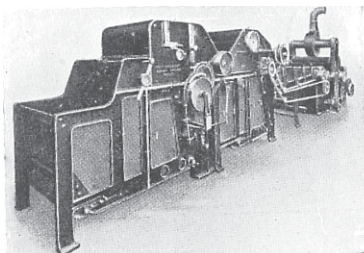

Combination of Machines  
for Opening and Lap  
Forming for Artificial Silk  
Staple Fibres, "Fibro,"  
"Vistra," Etc.

Carding Engine for  
Artificial Silk, Staple Fibres,  
"FIBRO," "Vistra," Etc.

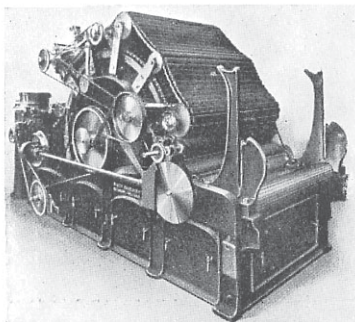

*Highest Awards of Merit at International and other Exhibitions  
for Textile Machinery, from London, 1851, to London, 1924.*

Telephones:  
No. 1806 OLDHAM.  
No. 5344 CITY.  
No. 2242 HOLBORN.

Codes:  
A 1, A.B.C., 4th, 5th and 6th Editions  
Western Union, Bentley's

Telegrams:  
"PLATTS, OLDHAM."

HARTFORD WORKS **OLDHAM** ENGLAND

# WROUGHT IRON PULLEYS



*with Interchangeable Bushes.*

By the use of Interchangeable Split Bushes, a pulley may be fixed on various diameters of shafting . . . . . We can supply Pulleys bored to any desired size with bushes turned to corresponding outside diameters and bored to fit any required diameter shafts, either English or Millimetre sizes. . . . . A Pulley out of stock is thus instantly available for any size of shaft for which a Bush is obtained. . . . .

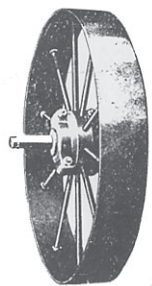

Pulley and Bush mounted on Shaft. Bush gripped by bolts in boss of pulley.

**DOUGLAS, LAWSON & CO. LTD.**  
**BIRSTALL**  
No LEEDS ENGLAND

## BUYERS' GUIDE.

Guide des Acheteurs  
Einkauf-Führer.  
Guia dos Compradores.

- Opening Machinery (Cotton).  
Ouvrages mecaniques pour le coton.  
Maquinaria de abrir algodón.  
Diradatrici (cotton).  
**PLATT BROTHERS & CO., LTD., OLDHAM.**  
Oil Storage Economisers.  
Economiseurs pour magasinage d'huile.  
Sparer fuer Oel-Aufbewahrung.  
Economisadores para Reservas de oleo.  
**KAY, JOSEPH, & SONS, LTD., LEEDS.**  
Patent Hopper Feeder.  
Appareils d'alimentation à trémie brevétés.  
Aparatos alimentadores patentados con tolvas.  
Apparechi brevettati a tramoggia per alimentazione.  
**PLATT BROTHERS & CO., LTD., OLDHAM.**  
Pickings.  
Garnitures.  
Verpackungen.  
Gaxetas.  
**LANCASTER & TONGE, LTD., PENDLETON.**  
Pickers (Loom).  
Taxiseta.  
Schlitzentreiber.  
Tacos (para leares).  
**BROMLEY, THOS. & SONS (PICKERS), LTD., BOLTON.**  
**HOWORTH, FIELDEN, LTD., WALSDEN, Near TODMORDEN.**  
**KERSHAW, JOSHUA & CO., (STOCKPORT) LTD., STOCKPORT.**  
Picking Bands.  
Fouets.  
Felschen.  
Tira-tacos para tares.  
**BROMLEY, THOS. & SONS (PICKERS), LTD., BOLTON.**  
Fisgas.  
Paistons.  
Kolben.  
Pistons.  
**LANCASTER & TONGE, LTD., PENDLETON.**  
Printing M. chinery.  
Machines pour l'impression.  
Macchine per stampare.  
Máquinas para estampar.  
**BRADBURY, SAUNDERS, LTD. (ENGINEERS), RADCLIFFE, Near MANCHESTER.**  
Pulleys.  
Doulies.  
Schriben.  
Dolies.  
**CROFTS (ENGINEERS), LTD., BRADFORD.**  
Ring Lasing Machinery.  
C'filocussas.  
Lampfenreismaschinen.  
Machinismos para abrir trapos.  
**BARNES & SYKES, LTD., ROCHDALE.**  
**GARNETT, P. & C., LTD., CLECKHEATON.**  
Ring Spindles.  
Broches de continn.  
Husos de continuas de anillos.  
Fusi ad anello.  
**PLATT BROTHERS & CO., LTD., OLDHAM.**  
Roller Coverings and Leather.  
Garnitures de Rouleaux et Cuir.  
Walzen-Bekleidungen und Leder.  
Capes para rolos e Coures.  
**FELL, G., & SON, BOLTON.**  
**KERSHAW, JOSHUA & SONS (BOLTON) LTD., BOLTON.**  
**KERSHAW, JOSHUA & CO. (STOCKPORT) LTD., STOCKPORT.**  
Roller covering Machines.  
Machines à couvrir les cylindres.  
Máquinas para cubrir cilindros.  
Rivestitrici di cilindri.  
**DRONSFIELD BROS., LTD., OLDHAM.**  
Roller Skins.  
Peaux de cylindres.  
Walzen-Häute.  
Peles para encapamento de cilindros.  
**FELL, G., & SON, BOLTON.**  
**KERSHAW, JOSHUA & SONS (BOLTON) LTD., BOLTON.**  
**KERSHAW, JOSHUA & CO. (STOCKPORT) LTD., STOCKPORT.**  
Scutchers (Cloth).  
Batteurs (pour nétoifes).  
Batanes (tegidos).  
Batitloré.  
**BIRCH, WM. (ENGINEERS), LTD., MANCHESTER.**  
**PLATT BROTHERS & CO., LTD., OLDHAM.**  
Selvedge Motions.  
Mouvements de Liaière.  
Leisten-Hewigungen.  
Dispositoes para cursias.  
**BUTTERWORTH & DICKINSON, LTD., BURNLEY.**  
Selvedge Printing Machines.  
Machines à Imprimer les liaières.  
Lohsen-Druck-Maschinen.  
Machinas para estampar ourelas.  
**FOXWELL, DANIEL, & SON, CHEADLE, MANCHESTER.**  
Sewing Machines (Piece-end).  
Machines à coudre les chefs de pièces.  
Máquinas para coser cabos de piezas.  
Macchine di cunire i capi delle payze.  
**BIRCH, WM. (ENGINEERS), LTD., MANCHESTER.**  
Shuttles.  
Navettes.  
Webschützen.  
Lancetras.  
**KIRK & CO. (BLACKBURN), LTD., BLACKBURN.**  
**LIVESEY, HENRY, LTD., BLACKBURN.**  
**PIONEER BOBBIN CO., LTD., BLACKBURN.**  
**WILSON BROS. BOBBIN CO., LTD., GARSTON, LIVERPOOL.**  
Silk Doubling Machinery.  
Machines à doubler la soie.  
Selden-Doublr-Maschinen.  
Machinas retercedetas de seda.  
**SCRAGG, E., & SONS, LTD., MACCLESFIELD.**

TEXTILE EXPORTER.

## BUYERS' GUIDE.

Guide des Acheteurs  
Einkauf-Führer  
Guia dos Compradores.

Singeing Machinery (Cloth)  
Machines à griller (tissus).  
Sengmaschinen für Tuch.  
Machines para chamuscar tecido.  
**BRADLEY, SAUNDERS LTD., RADCLIFFE, Near MANCHESTER.**  
**MATHER & PLATT, LTD., MANCHESTER.**  
**ROBERTS, R. R., LTD., BURY.**  
**SWINDELLS' ENGINEERING CO., MACCLESFIELD.**  
**TURNER, E., & CO., MANCHESTER.**

Spring Machines  
Machines à ressort.  
Schlichter-Maschinen.  
Máquinas esgornadeiras.  
**BUTTERWORTH & DICKINSON, LTD., BURNLEY.**  
**WHITLEY, WM. & SONS, LTD., LOCKWOOD, HUDDERSFIELD.**  
Spring and Slasting Machines.  
Machines à ressort et tencousseur.  
Máquinas de molas (tencousseur).  
Justifactory et moulins.  
**HACKING & CO., LTD., BURY.**  
**PLATT BROTHERS & CO., LTD., OLDHAM.**

Spring Makers  
Fabricants de Ressorts.  
Feder-Fabrikanten.  
Fabricantes de molas.  
**LUPTON BROS., LTD., ACCRINGTON.**

Spinning Machinery  
Machines à filer.  
Máquinas de hilar.  
Filarías.  
**HALL & STELLS, LTD., KEIGHLEY.**  
**PLATT BROTHERS & CO., LTD., OLDHAM.**  
**PRINCE, SMITH & SONS, LTD., KEIGHLEY.**  
**WM. WHITLEY & SONS, LTD., HUDDERSFIELD.**

Spring Top Motions  
Mouvements Supérieurs à Ressorts.  
Obere Feder-Bewegungen.  
Dispositivos de molas superiores.  
**BUTTERWORTH & DICKINSON, LTD., BURNLEY.**

Steam Traps  
Séparateurs d'eau de condensation.  
Kondens-Tropfen.  
Cais para condensado de vapor.  
**LANCASTER & TONGE, LTD., PENDLETON.**  
**ROYLES, LTD., IRLAM, Near MANCHESTER.**  
**WHITLEY, WM. & SONS, LTD., LOCKWOOD, HUDDERSFIELD.**

Steeler Clips  
Pices à étendre.  
Spann-Kluppen.  
Pinças esgornadoras do jaco para Máquinas alargadoras.  
**LUPTON BROS., LTD., ACCRINGTON.**

Steering Machines  
Raneuses.  
Spannmaschinen.  
Máquinas alargadoras de canno.  
**WHITLEY, WM. & SONS, LTD., LOCKWOOD, HUDDERSFIELD.**

Temples.  
Breithalter.  
Temperadores para faixas.  
**LUPTON BROS., LTD., ACCRINGTON.**

Towel Motions  
Mouvements pour tissus éponge.  
Frotterwaren-Bewegungen.  
Dispositivos para toalhas.  
**BUTTERWORTH & DICKINSON, BURNLEY.**

Warpers' Beams  
Encarpes d'ourdissage.  
Vorläufer.  
Opões para máquinas urdideiras.  
**TOMKINSON, J., & CO., LTD., OXFORD WORKS, STRETFORD, MANCHESTER.**

Warp Drawing Machines.  
Machines à rentrer la chaîne.  
Kett-Ziehmaschinen.  
Máquinas para tiragem dos fios de urdimento.  
**BARBER & COLMAN, LTD., BROOKLANDS, MANCHESTER.**

Warp Flyer Machines.  
Machines à mouer la chaîne.  
Kettfladen-Knüpfmaschinen.  
Máquinas para fazer noe em fios de urdimento.  
**BARBER & COLMAN, LTD., BROOKLANDS, N. MANCHESTER.**

Warping Machinery.  
Machines d'ourdissage.  
Tettel-Maschinen.  
Máquinas urdideiras.  
**HACKING & CO., LTD., BURY.**  
**WHITLEY, WM. & SONS, LTD., LOCKWOOD, HUDDERSFIELD.**  
**PLATT BROTHERS & CO., LTD., OLDHAM.**

Waving Reeds.  
Pérgos à tisser.  
Webebblätter.  
Pentes para tecelagem.  
**E. TH. WAGNER, CHEMNITZ, GERMANY.**

Winding Machinery  
Bobinoirs.  
Arrolladoras (bobinadoras).  
Avvolgitori.  
**HACKING & CO., LTD., BURY.**  
**PLATT BROTHERS & CO., LTD., OLDHAM.**

Wire Healds.  
Lignes métalliques.  
Drahlisen.  
Ligas de arame.  
**E. TH. WAGNER, CHEMNITZ, GERMANY.**

Yarn Stoving Plant.  
Installations d'étuvante de fils.  
Barnschweißanlagen.  
Gesechtes de fios.  
**TURNER, E., & CO., MANCHESTER.**

## LUPTON BROS. LTD.

INCORPORATING  
JAS. BLEZARD & SON PADHAM  
ESTABLISHED 1859

GRANGE IRONWORKS, ACCRINGTON, LANCASHIRE.  
& GUY SPRINGWORKS, MANCHESTER EXCHANGE, 17, DILLAL, TUESDAY & FRIDAY, P. 10.30 P.

### TEMPLES & SPRINGS

REGISTERED  
TRADE MARKS

Makers of Patent Ring and Roller Temples in every variety. Temple Rollers, Flat and Spiral Springs, Loom Spindles.

Well Forks, Well Grates, Perforated Steel and Brass Strip and Sheets and Textile Accessories Generally.

REVOLZE  
SPANDIT



16R. 17 rings can be made with any number of rings.  
Special Temples for Artificial Silk and Bradford Goods.  
TEMPLE ROLLERS IN GREAT VARIETY.  
Large orders for the Trade specially solicited. Illustrated lists and sample gladly supplied.

# DYEING & FINISHING MACHINERY

*For Woollen, Worsted & Cotton Cloths.*

ALSO FOR

*Silks, Plushes, Sealskins, Rugs, Fustians,  
Moleskins, Carpets, etc.*

OTHER SPECIALITIES:

DYEING MACHINES FOR  
ARTIFICIAL SILK HANKS,  
WOOLLEN AND COTTON  
HANKS.

SHEARING MACHINES OF  
ALL TYPES FOR CLOTH,  
PILE GOODS, SKINS,  
FELTS, CARPETS, RUGS,  
AND MATS.

SEALSKIN AND PLUSH  
MACHINERY. MAKERS OF  
COMPLETE DYEING AND  
FINISHING EQUIPMENT  
for all TEXTILE FABRICS.

# Sellers

AND COMPANY (HUDDERSFIELD) LTD.

ENGINE BRIDGE MACHINE WORKS,

Grams :  
MACHINERY,  
HUDDERSFIELD

HUDDERSFIELD.

Phone :  
HUDDERSFIELD 1601



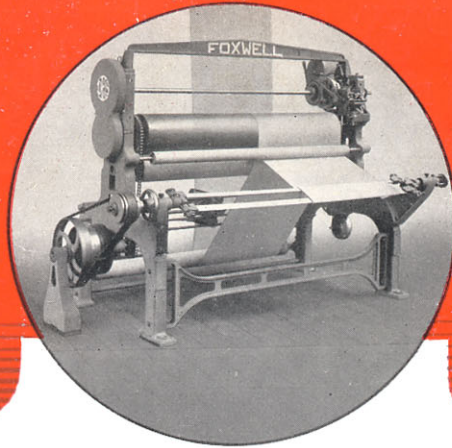

The "FOXWELL"  
AUTOMATIC SELVEDGE  
PRINTING MACHINE

*(Latest and Improved Type)*

- ¶ PRINTS NAMES, TRADE-MARKS, LENGTHS, ETC., ACCURATELY AND EVENLY SPACED ON THE SELVEDGES OF TEXTILE FABRICS.
- ¶ NO HAND LABOUR IS REQUIRED TO GUIDE THE FABRIC.
- ¶ BETTER AND MORE RELIABLE RESULTS ARE OBTAINED AT A GREATER SPEED THAN BY ANY OTHER MEANS—80 TO 120 YARDS PER MINUTE.
- ¶ BY FAR THE BEST AND CHEAPEST IN THE LONG RUN.

**FOXWELL**

AND SON,



CHEADLE

NEAR  
MANCHESTER.

**JOSEPH STUBBS LTD.**  
**MILL STREET WORKS, ANCOATS,**  
**MANCHESTER**

*Machinery for*  
*Winding, Doubling, Clearing, Gassing,*  
*Reeling, Preparing, Polishing, Bundling,*  
*all classes of*  
***Yarns and Threads***

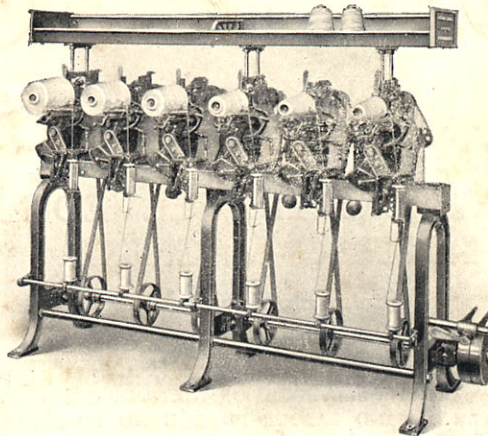

*Patent "Ozri" Cone Winder winds  
large Cones for knitting purposes.*

*Telephone:*  
*Ancoats Works,*  
*City 2447 (3 lines)*

*Telegrams:*  
*"WINDING,"*  
*Manchester.*

**See our Stands at**  
**Exhibition:**

**Nos. 18 & 19,**  
**Row B.**



LTD., MANCHESTER.