

G A R D E N S T U D I O Q U A R T E R L Y

a n d

W E A V I N G S E R V I C E

Volume 1 Number 4

October 1933.

Myra L. Davis & Kate Van Cleve

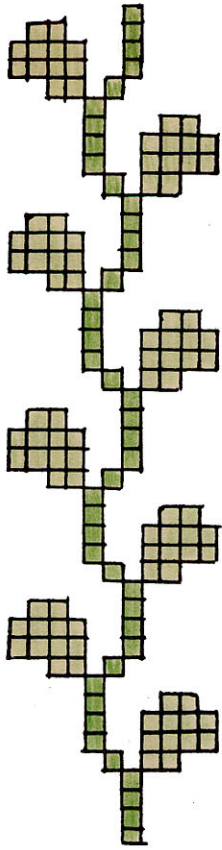

1

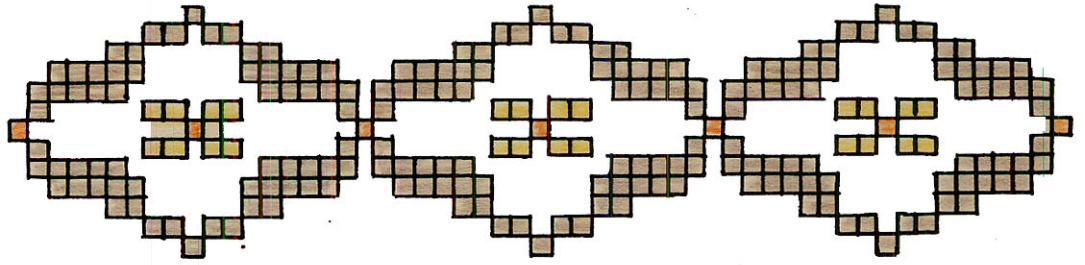

2

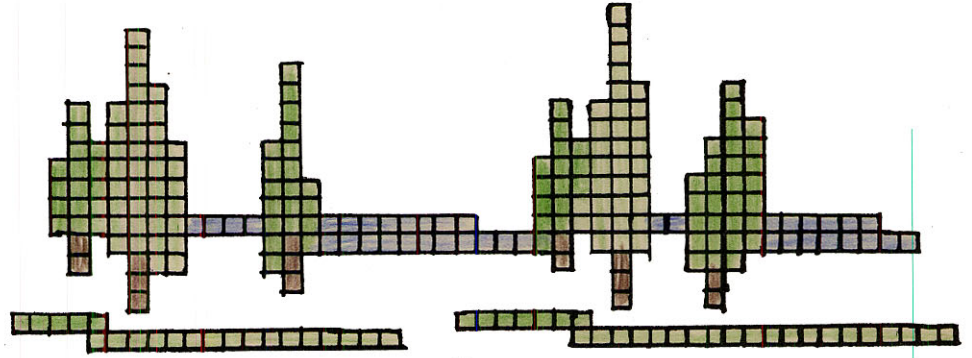

3

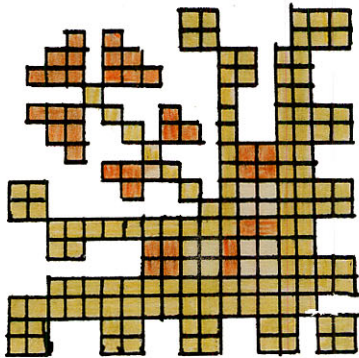

4

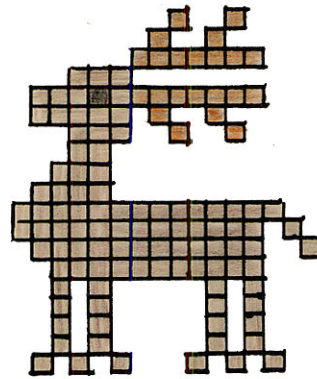

5

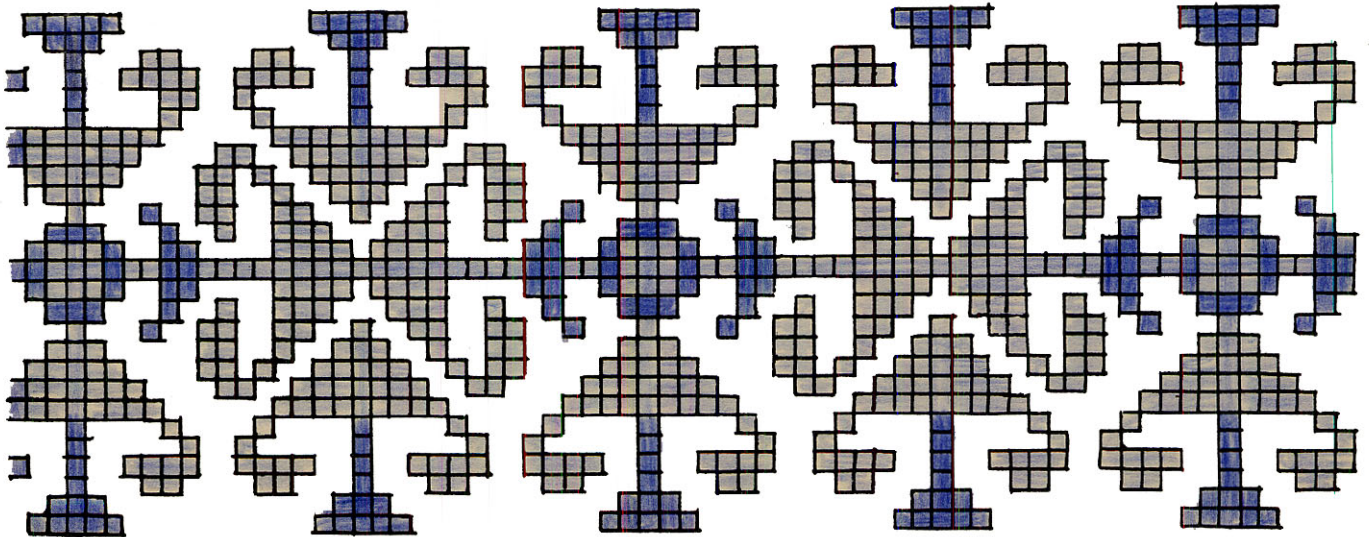

6

TRAY SET.

Cloth and Two Napkins.

Warp - 40/2 white linen or 20/2 cotton, 552 ends set 24 to the inch.

Weft - No. 14 white linen.

Design No. 4 in Swedish Embroidery weave using 2 thread blocks.

Bernat's Linen Weaver - Yellow No. 237, Orange No. 239.

The tray cloth should measure 22 x 12 inches, and the napkins 9 x 9 inches.

Tray Cloth:- Weave $1\frac{1}{2}$ inches plain, then weave the design in each corner, setting them in $1\frac{1}{2}$ inches from each selvage. After finishing the corners, weave 7 inches for the center, which will allow for shrinkage. Then repeat the designs in the opposite corners, remembering to reverse them. Finish with $1\frac{1}{2}$ inch plain.

Napkins - the two napkins may be woven at the same time on this 22 inch width. Weave 1 inch plain, then a design 1 inch from each selvage, and finish with 7 inches plain. This gives a design in one corner of each napkin.

Finish both cloth and napkins with a $\frac{1}{4}$ inch hem. If fringe is desired, draw a thread one inch from each edge of the cloth and $1\frac{1}{2}$ inch from each edge of the napkin, and stitch on the sewing machine with a fine stitch in the space where the thread was drawn out. Then fringe back to the line of stitching. This makes a much more satisfactory finish than overcasting.

Design No. 1 is very good for luncheon sets, or it might be used on the tray set instead of No. 4. No. 2 is nice for narrow runners, guest towels, or curtain tie-backs. No. 3 for guest towels, runners and small pine pillows. No. 4 for luncheon sets or wherever a small corner design is needed. No. 5 on articles for camp use. No. 6 for library or living room table runners, chair sets or curtains.

Four Keys

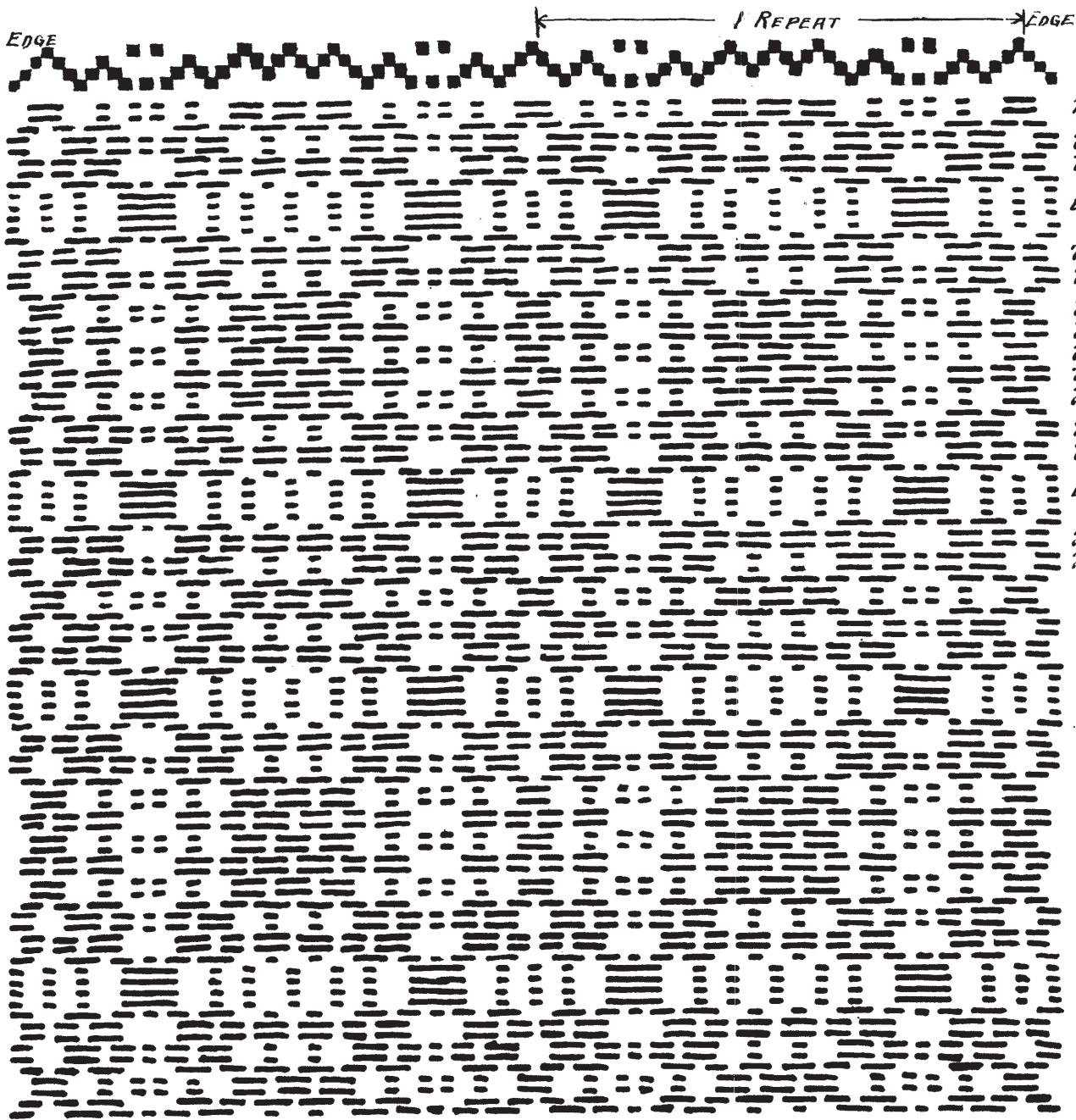

- 2(3-4)
- 2-3
- 2(1-2)
- 2(2-3)
- 1-2
- 4(1-4)
- 1-2
- 2(2-3)
- 2(1-2)
- 2-3
- 2(3-4)
- 2(2-3)
- 2(3-4)
- 2(2-3)
- 2(3-4)
- 2-3
- 2(1-2)
- 2(2-3)
- 1-2
- 4(1-4)
- 1-2
- 2(2-3)
- 2(1-2)
- 2-3

BOOK COVER.

Draft - Four Keys.

Warp - 20/2 cotton, 271 ends set 30 to the inch, using a No. 15 reed sleyed 2 in a dent. This gives 6 repeats of the pattern and the selvages.

Weft - Pattern - Perle cotton No. 5, binder Perle cotton No. 20.

Suggested color combinations:

No. 5 1048 golden brown
No. 20 1042 dark blue

Copper
No. 5 1008
No. 20 1009

Taupe
No. 5 1014
No. 20 1013

Beauvais Rose
No. 5 1025
No. 20 1026

Green
No. 5 1054
No. 20 1053

These are all Bernat's materials.

Weave $\frac{1}{2}$ inch heading with the binder thread, then weave alternate shots of pattern thread and binder for $2\frac{1}{2}$ inches. This is for the pockets on the inside of the cover.

Weave 9 repeats of the pattern ($13\frac{1}{2}$ inches), then repeat the alternate shots of pattern and binder threads and the $\frac{1}{2}$ inch heading. Make a hem of the heading on each end; turn the rest of the plain weaving back and overhand the selvages together to form the pockets. A cord made of 8 strands of the binder thread very tightly twisted, then doubled in the middle and twisted again should be sewed in the center of the top edge to serve as a book mark. The free end should be knotted $\frac{3}{4}$ of an inch from the end and untwisted to make a tassel.

FORGET - ME - NOT

X

B

H

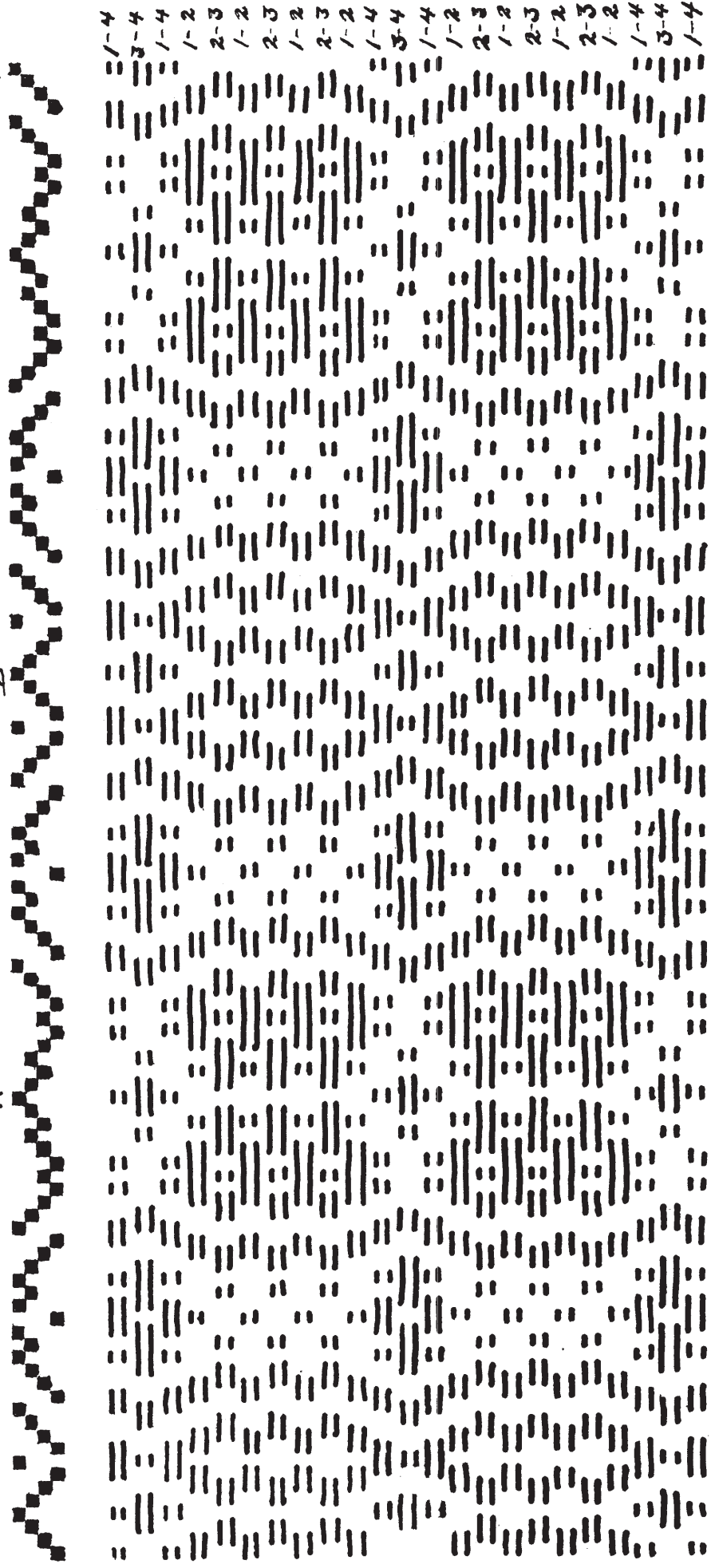

UTILITY CASE

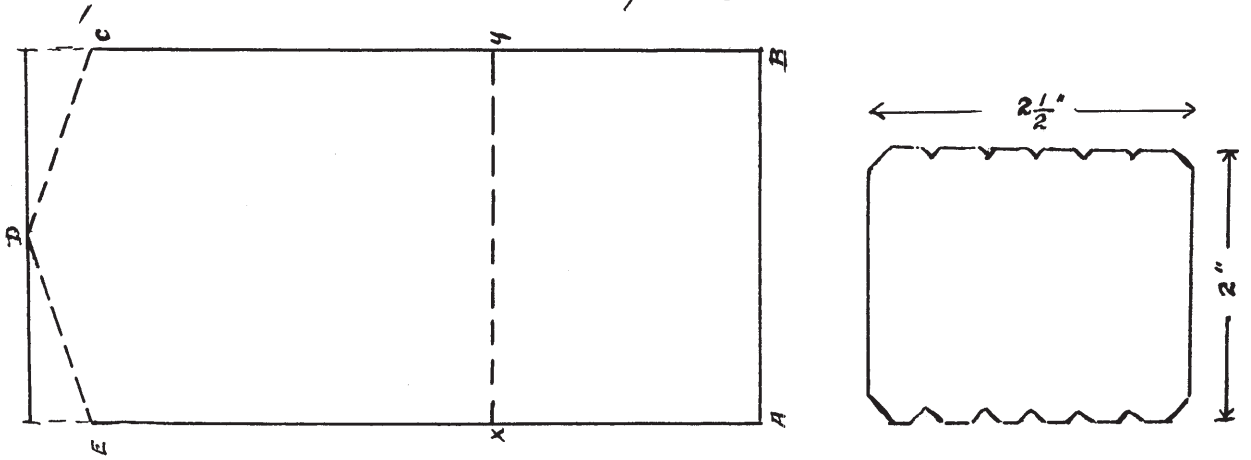

TRAVELING CASE

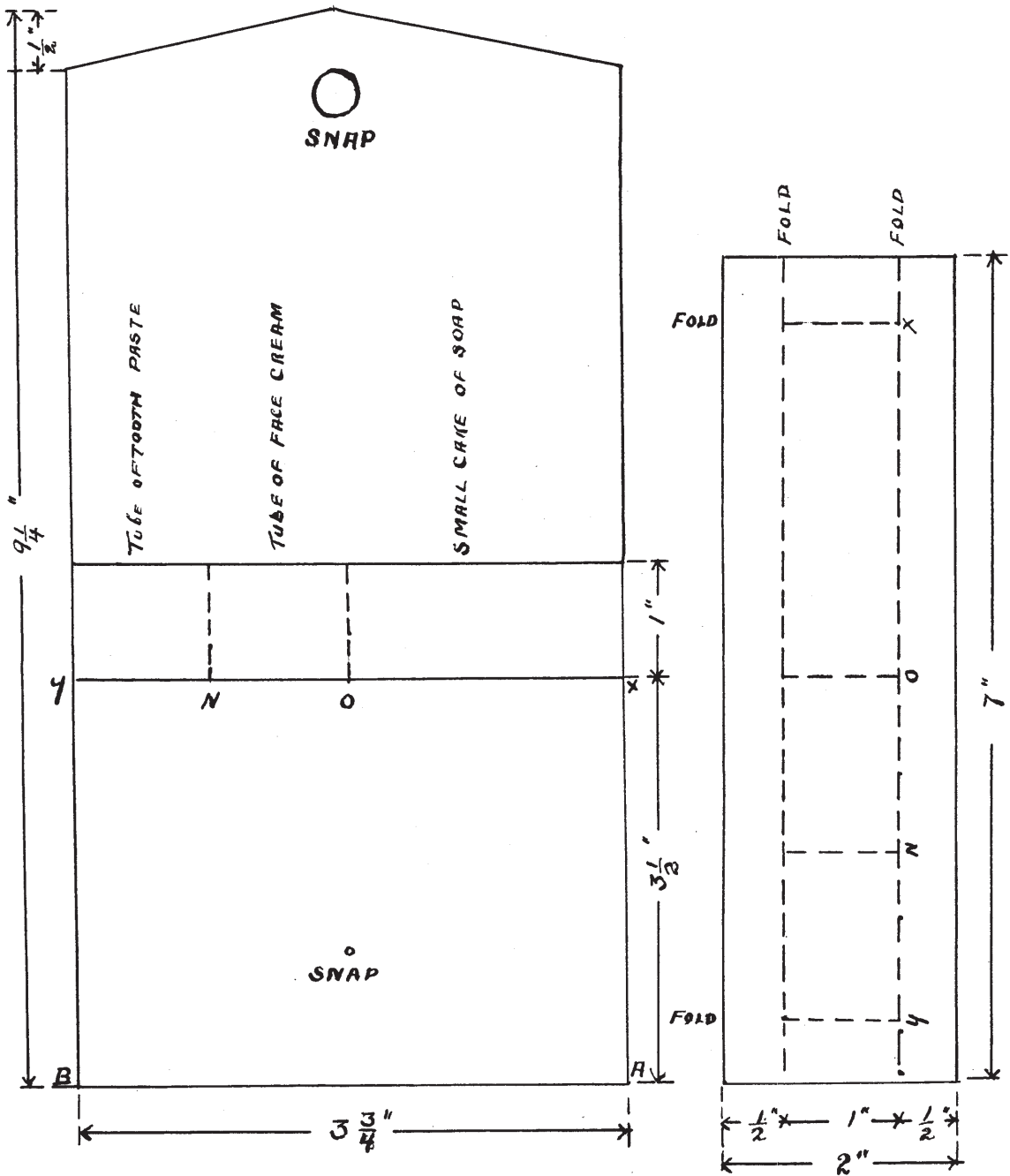

UTILITY CASES

Draft - Forget-me-not.

Warp - 20/2 Mercerized cotton in color. 15 dent reed, sleyed
2 in a dent.

Weft - Artspun. (Garrett's material).

Threading - Begin at the right of draft and thread from A thru
B with B as center, reverse back thru A to complete
pattern.

Weave - 1/2 inch of heading with binder thread (same as warp).

Weave 9 repeats of pattern, finish as you began it.

This should make it a little more than 5 1/2 inches long.

To make up case, buy ribbon the width of strip and 1 inch longer
to harmonize with the pattern thread. Sew snap on the outside (1).
Begin at A to overhand the ribbon across the end, then up the side
from B to C (the end for the flap has already had the corners turned
and run). Sew the other half of the snap on the point of the ribbon
lining, overhand from C to D and E and down the side from E to A.

Fold 3 repeats of the pattern to make the pocket (on X & Y)
and overhand the ends. Cut cards as illustrated and wind with brown,
black and grey darning cotton and black and white thread. Be sure to
trim off the corners of the card so it will slide in and out of pocket
easily. Run 2 needles, 3 colored pins and 3 small safety pins in the
silk lining of the flap.

TRAVELING CASES.

Draft - Forget-me-not.

Warp - 20/2 Mercerized cotton in color. 15 dent reed, sleyed
2 threads in a dent.

Weft - Artspun. (Garrett's material).

Lining, 1/4 yard of permatex will make several cases as it is 36 inches wide, this is a water proof material and may be purchased at 50¢ - \$1.00 per yard from Fellowcrafters, 18 Beacon Street, Boston, Mass. (samples inclosed).

Threading loom, begin at the right edge, thread from A thru X and reverse back thru A to complete the pattern. X is the center thread.

Weave 1/2 inch heading and as many repeats of the pattern as required for a piece 9 1/4 inches long and should be about 4 3/4 inches wide when woven. Finish with heading.

To make up, run the heading of your piece of weaving and turn the edge and run flat, then turn the edge for the flap as shown in the drawing at Z. Cut a piece of permatex 3/4 of an inch longer and wider than your piece of weaving, turn the edge and fold back 3/8 of an inch on all sides making a shallow point to fit the flap and crease. Cut a piece of permatex 2 inches wide and 7 inches long, turn half an inch on each long edge and crease.

Place the long strip 3 1/2 inches from the corners A and B so that X on the strip is on X on the lining, O on O, N on N, and Y on Y, stitch in place on the sewing machine with thread to match the lining.

Place completed lining on woven outside and stitch around the outside edge with thread to match the permatex for the upper and sewing silk to match the outside for the bobbin.

Put in snap fastener as shown in the drawing.

Snap fastener kits may also be obtained from the Fellowcrafters for \$1.00. Snaps in plain colors for \$.20 per dozen.