

# THE MINNESOTA WEAVER

Vol. 4, No. 2 October 1978

**COMING  
UP**



## OCTOBER PROGRAM

Thursday, October 5, 1:00 p.m. and 7:00 p.m.

Our first meeting of the season in the new Guild will consist of an open house to illustrate the functioning of the various Guild committees. Sue Mansfield from properties will give a short talk on loom maintenance; the Library committee will be set up in the library to explain their procedures; *The Minnesota Weaver* staff will discuss the putting-together of the newsletter; and the Yarn committee will describe yarns and ordering procedures.

## ELECTIONS TO BE HELD AT OCTOBER MEETING

Nominees for the positions of President Elect and Education Director will be voted on by the membership at the Guild meeting on October 5. The Nominating Committee will present candidates Lindy Westgard for President Elect, and Nancy Haley for Education Director. Nominations will also be accepted from the floor.

## OCTOBER EXHIBIT IN THE GUILD ROOMS

The Studio Exhibits Committee has chosen the topic of "Openwork" for the first exhibit to be hung in the new Guild rooms. Loom controlled laces, such as Bronson Lace, hand manipulated lace weaves, such as leno and warp bouquets; and meshwork pieces in the sprang technique will be among the pieces on display during the month of October.

## NOVEMBER PROGRAM

Thursday, November 2, 7:00 p.m.

Marj Pohlmann will speak on history of textiles used in religious basis with concentration on contemporary use and design considerations in a lecture entitled, "Fabric as Symbol." Slides and small scale models will be used and some pieces woven by Marj will be exhibited. This program is a sequel to Marj's seminar at the Minneapolis Institute of Arts and will cover different material.

## FIBER FAIR DATES TO REMEMBER

October 18, (Wednesday) 7:00-9:00 p.m.

October 19, (Thursday) 1:00-3:00 p.m.

Selection Committee review of new entrants and anyone with questions concerning their entry

November 13 (Monday) 11:00 a.m. to 8:00 p.m.

Check-In for all items sold at the Fiber Fair

November 14 (Tuesday) 9:00 a.m. to 4:00 p.m.

Staging- arranging of items to be displayed

November 15 (Wednesday)

Press Preview

November 16 (Thursday) 7:00-9:00 p.m.

Grand Opening with demonstrations

November 17 (Friday) 11:00 a.m.-5:00 p.m.

Public Sale

November 18 (Saturday) 5:00-6:30 p.m.

Check-out of all items not sold.

6:30-8:00 p.m. Cleanup--

## 1978-79 GUILD PROGRAMS

October 5	1:00-3:00 p.m. and 7:00-9:00 p.m.	Open House and Committee Reports
November 2	7:00-9:00	Liturgical Design by Marj Pohlmann
December 7	1:00-3:00 p.m.	Peruvian Textiles and mini-tour of New St. Paul Arts & Science Center Baizerman, Searle, Sewell
February 1	1:00-3:00 p.m.	reservation of Exhibition Textiles by Lotus Stack
March 1	1:00-3:00 p.m.	Early American Yardage Weaving by M. Susan Brock
April 5	7:00-9:00 p.m.	Looms of N.W. Coast Indians by Pat Boutin Wald
May 3	7:00-9:00	Coverlets by Peggy Dokka

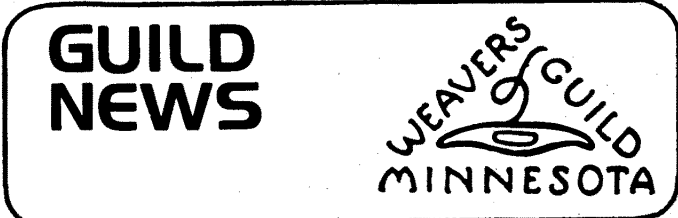

- GUILD OFFICERS**
- President.....Joy Rosner, 824-7045
  - Vice President.....Edis Risser, 922-6596
  - Secretary.....Ruth Arnold, 544-0779
  - Treasurer.....Patricia McHugh, 922-9500
  - Member Affairs Director.....Marjorie Jirousek, 925-2296
  - Outreach Director.....Irene Wood, 831-1126
  - Past President.....Susan Obrestad, 777-2657
  - Past President.....Helen van den Berg, 377-4721
- Office Staff**
- Guild Coordinator . . . . . Suzette Bernard, 644-0263
  - Office Manager . . . . . Margarte Pidde, 644-3594
- Office Hours**
- 9:00 a.m.-3:00 p.m. 6:30-8 p.m. Weekdays
  - 9:00 a.m.-12:00 noon, Saturday

**September 14th Board Meeting -- Summary of Minutes**

The finance committee presented budget projections and explained the rearrangement of categories to reflect actual money flows. It was emphasized that only the designated money can be expected to be available and that in all cases spending must be kept within budgeted amounts. Committees will be keeping detailed records of expenditures to aid in future budget planning. All expenditures must first be authorized. The Board will soon hold an additional session to have time to look at long range goals and priorities. Publicity will be increased to highlight Guild activities and events. A supply of informational flyers and class bulletins will be available for those traveling and demonstrating.

An Open House for the new Weavers Guild location will be held in connection with the November 17 & 18 Fiber Fair.

Necessary window remodeling for the dye lab and main room windows will be completed for \$250; the building fund money will be used for this.

**STATE FAIR '78** Ruth Arnold, Secretary  
 State Fair '78 is now history, and so many weavers and weavings again played a significant part in making the Creative Activities Building such an interesting, inviting, attractive place! The many lovely weavings displayed in the Weavers Guild case, made a proud exhibit and attracted much interest. The weavers and spinners who worked in the demonstration booths the twelve days of the Fair attracted even more. We are grateful to the more than seventy demonstrators who gave so generously of their time, smiles, talents, and so graciously answered the many questions from the audience as they worked at a floor loom, frame loom, band weaving, or spinning. The crowds of young and old that gather around the spinners, in particular, never seem to thin out or lose their fascination. Weavings entered in competition were more numerous this year, and of excellent quality. Among those who won the coveted First Place blue ribbons in the various categories were the following Guild members:

- Band weaving - Mary B. Johnson, St. Paul
- Bedsread or Coverlet - Janet Meany, Duluth
- Clothing Accessories - Judy Freeberg, Bloomington
- Place Mats - Elizabeth Reineke, Lake City
- Bag or Purse - Mary B. Johnson, St. Paul
- Table runner or cloth - Elizabeth Reineke

- Ladies' Garment - Louise Cameron, St. Paul
  - Man's Garment - Susan Mansfield, Golden Valley
  - Pillow - Carol Lowry, Excelsior
  - Poncho - Mary Schnitzler, Bloomington
  - Stuffed Toys - Judy Freeberg
  - Wool Growers Award - Louise Cameron
- Congratulations to all!

Dorothy Christensen

**STATE FAIR EXHIBIT REPORT**

Thanks to Dick Abell, U of M Design Department, we had more exhibit space than ever before at the State Fair. The Handspinners Study Group was spotlighted in a display case of their own, separate from the regular Guild exhibit. It had a brief description of color project and displayed both dyed and carded fleece and items made from the handspun. It was also identified as a Weavers Guild project so everyone could see the type of exciting activities we have available to our members.

Thanks again to everyone who submitted items for the exhibit and to Dick Abell for making it all possible.

Dianne Swanson

**TV SPOT FOR GUILD**

Pat O'Connor appeared on the "What's New?" television show on WTCN-TV from the State Fair Grounds on Thursday, August 31 She did a beautiful job of telling about the Guild and explaining the Guild booth in the Creative Activities Building. Thanks again, Pat, for being a fine representative of the Guild.

**FASHION SHOW**

There is a movement to organize a fund raising fashion show of handwoven clothing and accessories. If you are interested, we will hold an organizing meeting at the Guild, 2402 University Avenue, St. Paul on Thursday, October 19 at 7 p.m.

We need models, a narrator, a writer, a general organizer, committee members, dressers, and handwoven clothing of all kinds. We have had one brainstorming session during the summer, but more thoughts are still welcome. Please come to see the good idea to fruition.

---



**wool-n-shop**  
 101 27th ave. s.e.

**fiber, tools and books  
 for handspinners**

**100% wool yarn, fabric and clothing  
 long wool fabric strips for  
 woven or braided rugs \$1<sup>25</sup>/lb.**

## FOR TRAVELERS AND DEMONSTRATORS

Are you planning to travel soon? Will you be visiting a weaving group or individual? Will you be demonstrating any of the fiber arts? Take some literature about the Weavers Guild of Minnesota along with you! Help publicize us! New people are important.

## LOGO CONTEST REPORT

The several entries received are being given consideration - However, we'd like to have more to choose from - If you feel a neat Guild graphic coming on, send it to the office.

## ACROSS THE RIVER: HISTORICAL THOUGHTS

The Weavers Guild has accomplished its move across the Mississippi River to its new home in St. Paul near the Minneapolis border. Boxes are empty, paint dry, carpentry projects progressing, and every day the Guild looks more settled. Despite the disruption, it was business as usual, uninterrupted. Margaret, our office manager, is amazing in her ability to function under every imaginable condition. Everyone every day is helping to make our space inviting, homey, and attractive, a spirit we hope will continue long past our settling.

Hundreds are responsible for the move itself, an incredible feat, but I wish to address this column primarily to those involved in the Search for Space. This is by way of a tribute to them, and a thank you for time and effort spent.

Autumn 1976: Members of the Board of Directors, under Helen van den Berg's leadership, located a warehouse on the Mississippi River near 3rd Avenue Bridge in S.E. Minneapolis, where concerns about availability of public transportation, partitioning and night safety eventually forestalled a move there. Small groups looked at empty shops, departing businesses, old homes, warehouses, and abandoned clubs in every part of St. Paul and Minneapolis.

Late Winter 1977: Patricia McHugh, Nancy Leighton, and I were appointed by the Board to be the Search Committee. Others later joined us, Lindy Westgard in particular. We polled and questioned members about their needs and desires for a new space. Nancy set up a card file of every possibility we pursued. Nothing we saw nearly met our stated desires.

Spring 1977: The Woolgrowers building in S.E. Minneapolis became a possibility. Many members of the Board, some of the committee chairmen, and the Search Committee negotiated with Woolgrowers about their second floor warehouse. Marj and Charles Pohlmann spent hours drawing possible plans. Contractors gave bids. Facing the shocking realization that it would take nearly \$80,000 to partition and improve the Woolgrowers space, we turned our search elsewhere.

Summer 1977: Patricia and Lindy stumped the streets, and though many interesting places appeared, they were discarded for a variety of reasons: too isolated, no parking, impossible to improve without large expenditures of money, no direct public transportation, too far into St. Paul or Minneapolis.

Autumn 1977: When I returned from my summer away and began again as the Guild's Administrative Assistant, part of my charge was to find the Guild a new home. The Firehouse at Oak and Washington came up for bid, but without the financial means to purchase and renovate a building of our own, we weren't able to do more than drool over it. Lindy later found two more firehouses, lovely places, but with the same problems.

Winter 1977: Discussions at District 12 South St. Anthony Park meetings about Baker School attracted us. Plans were afoot, we're told, to convert Baker School into a center for the arts, but the St. Paul School District had contrary ideas (and still has not committed itself to the future of that incredibly functional building on Raymond Avenue a block north of University). We contacted local realtors on the Midway area (loosely defined from the U. to Snelling Avenue straddling University Avenue a half mile north and south). Many places turned up, but nothing planned out. One was a wreck, another was not heated adequately, a third had no available bathrooms, a fourth was not zoned properly for our use, a fifth has excessive noise from adjoining businesses, a sixth was too far off the beaten track, and every one of them needed much in the way of painting, repairs, partitioning. None has adequate (or any) off-street parking. We were very discouraged.



June 27, 1978: I received a call from a Guild friend, a silk-screen artist whose business is in the Chittenden and Eastman Building, informing us of the space where the Guild currently resides. Apprehensively I agreed to look at it, expecting more of the same. Once visited, I was afraid to be optimistic about others' reactions to a space which I felt would suit the Guild very well. Nonetheless, we organized a band of board members and committee heads quickly to take a look. Everyone felt positive, and the reservations seemed surmountable. A third visit by the out-going and the in-coming Boards confirmed that this space would at last be suitable. We arranged an open house for the members, and a special Board meeting, took a vote, and made THE decision. I leave it to others to tell the rest of the story.

In the long and short of it, it all comes down to hours of patience and hard work on the part of many people who trekked the streets with eyes wide called when they saw For Rent or For Sale signs, lent me their wild and mild ideas. With all this help, we were bound to succeed.

I thank every single individual who contributed to the search and the move. If I don't mention your name, it is not that I don't know who you are. It would take pages. Every contribution helped in the end. It is clear that the members care about this organization and will participate in its activities, support its programs, and most of all spread the news of our search ended.

Kathie Frank



## MOVING DAY

Moving of the Weavers Guild from one building to another could have been a nightmare and wasn't, thanks to good advance planning and lots of help. During July, a committee Chaired by Cathy Ingebretsen and Nancy Haley worked out a floor plan for the new space with every property in place. During the week of packing prior to the move, looms, boxes, and everything else was color-

coded according to what room they belonged in. Most of the painting was done in advance.

On Saturday morning the 26th, by the time Paul and I arrived with a large furniture-delivery truck, looms and other properties were already out on the sidewalk, station wagons and vans were being loaded. There were lots of people in action and enough vans and trucks so that none had to be loaded more than twice. A stream of people with loads of Guild stuff moved down the wide back stairs and up for more. One of the brilliant remarks of the day can from someone going to rehearsal on the third floor. Looking into our empty rooms and around at the people carrying boxes out, she said, "Oh, the Weaver Guild must be moving out today."

Another comment from a bystander outside, watching the trucks being loaded, "Do you have a place to go?"

It was a hot, humid day and about noon one man voiced his suspicions that his deodorant had failed him. He was in good company.

The Guild rooms on Cedar Avenue were emptied by early afternoon. Marjorie Jirousek pulled the door shut behind her and felt she has set a record of sorts; she was the one to lock the doors on Cater & Como in March of '74.

Meanwhile over at the Chittenden & Eastman building, more people unloaded all these vehicles and got things into the new rooms. Even in the earliest stage, the Guild looked better in its new environment. It was impressive to see those big empty rooms fill up and begin to look unmistakably like a Weavers Guild.

Even though there were plenty of people to help and it all went smoothly, there were weary bodies and aching muscles by the time we finished. Those who gathered at the Westgard's for a potluck supper afterwards had a good time together. The Westgard's hospitality brought moving day to a pleasant, relaxing close and should inspire us to work together and share potluck more often

Sue Obrestad



## THANK YOU WORKERS

### Painting before Moving Day

Ruth Delsart and husband  
Beryl Smith  
Phyllis Pladsen  
Cathy Ingebretsen  
Pat & Paul O'Connor  
Jean Lodge  
Lindy Westgard and Lisa, Erik, and Richard  
Edis Risser  
Nancy Haley  
Sue Obrestad and Nathan

### Moving

Margaret Pidde  
Suzette Bernard  
Diane Swanson  
Lindy, Eric & Lisa Westgard  
LaVerne & Gene Hornby  
Shirley, Bert & Greg Herrick  
Cathy and Jim Ingebretsen  
Sue & Paul Obrestad  
Karen & Dave Searle  
Helen & Kent van den Berg  
Edis Risser  
Kathy McMahon  
Joy Rosner & Hannah  
Jay Magoffin  
Elaine Phillips  
Mary B. Johnson and Elizabeth  
Louise Cameron  
Bertha & Obert Motenberg

Derva Minear and husband  
Debbie Alper  
Susan Dimond  
Andrea Singleton-Blue and husband Jerry  
Nancy Haley  
Traudi Bestler, husband & son  
Paul O'Connor  
Marjorie Jirousek  
Karen Peel and friend  
Pat Boutin Wald and husband Al  
Cathy MacDonald  
Charlotte Haglund  
Judy Howe  
Edith Schultz  
Sue Mansfield  
Vivian Guild

Private Lessons in  
Four Harness Weaving



LYNNE NORRIS  
612-933-8104

Take a four harness table loom home  
to use between lessons; use a floor  
loom in my Minnetonka studio.

\$50+ materials, four weeks. 933-8104

## October 2-8 1st Annual Fall Sale



At least 15% off everything including our new arrivals.  
100's of fabrics reduced 30-50%. Final markdowns to  
70% off selected yarns and clothing.

# depth of field

405 Cedar/Mpls. Rosedale/St. Paul, Ridgedale/Minnetonka

# GUILD COORDINATOR

by Suzette Bernard

## COMMITTEE POSITIONS STILL AVAILABLE

As our Guild grows and grows, it takes an ever increasing number of people to make our committees work. There are several vacant positions available to anyone who would like a year of challenging and interesting work and fun. And, you could help in any area of interest--workshops, programs, classes, office help, yarn co-op, properties, or any other Guild activity. So won't you share a little--or a lot if you like--of your time with your Guild. Just give me a call and we'll have something for you to do.

## NEIGHBORLY REMINDER

Now that we're in a nice place, new place we need a gentle reminder about being neat and tidy. Please be sure to pick up after yourself--there are brooms, mops, and a shop vacuum available in the storeroom. Even the simple act of carding fleece can leave dirt, lint, and small fly-a-way pieces of wool in your work area. And be sure to put something away if you take it out for use. Fall is the busiest time for classes and all rooms should be ready for use at all times.

And for brown baggers--please put your lunch and snack refuse in the kitchen wastebasket only. The other waste baskets around the Guild are for yarn and paper scraps and get emptied only when full.

## WGM FIRST (ONLY?) MUG-IN

All the coffee cups and mugs have been cleaned and scrubbed and will be hung on hooks on the pegboard in the kitchen. So... when you come in ... claim your cup. There will be a dispenser of write-on tape handy so you can label your cup for your personal use.



Guild coordinator Suzette Bernard, left, and Office Manager Margaret Pidde, in the new Guild office.

## GUILD DONATIONS

The Guild can still use donations from your fall housecleaning sprees. Besides the items listed in the October Weaver we could use a metal storage cabinet (lockable) for chemicals and dyes in the dye lab, additional shelving for most of the rooms, and willing workers to help settle in. Anyone willing to do simple carpentry work like putting up display boards, shelves, etc. would be greatly appreciated. We have had many contributions already but need many more items to furnish our "home."

## POSITION AVAILABLE

We are looking for an evening and Saturday office assistant to staff the Guild during classes. If you are interested, please contact either Margaret or me at the office.

## FROM THE PRESIDENT

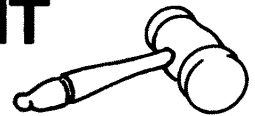

Dear Friends,

Welcome all of you in the 39th year and to the new beautiful quarters of the Weaver's Guild of Minnesota. I am looking forward to seeing you, talking to you, working with you, sharing thoughts on fiber arts and seeing the fruits of our craft this coming year.

The move to Chittenden -Eastman Building has been a most exciting time for all of us. So many people have been enthusiastically volunteering time, muscle, goods, and money to make the move a success.

It has also been so exhilarating to see how willingly and unselfishly our friends have volunteered to help in the running of the guild and how our employees have done so much beyond the call of duty so that we, whether we are a hobby person or a person who has chosen fiberarts as a profession, may be provided with so many services. Throughout the Weaver this month, you will see some of these many people mentioned. We have tried to keep track of the many of you who have dropped in, sometimes unheralded and unsolicited, and done so much. Let me personally thank you--the Guild is you--and it owes its very existence to you. We have all grown and will continue to grow as fiber craftspersons and artists because of your continuing interest, participation, and support.

May I invite you to attend Board meetings on the 2nd Thursday of the month at 9:30 a.m.

I hope that you will let me know what you are thinking about fiberarts and the Guild, I will have regular office hours at the Guild--Thursdays from 9 a.m. to 3 p.m..

Joy Rosner

# LIBRARY NEWS

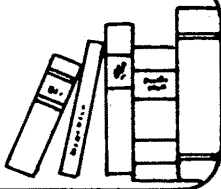

## LIBRARY NEWS

Members visiting the Guild at 2402 University Avenue will immediately be drawn to the new library. Carpeted, quiet, well-organized space including a comfortable chair for browsers and a table for those who wish to study is what one will find. Though the library will still share its space with the yarn co-op, there will be a "place for everything and everything in its place."

Over the summer, the library has received several new books, reviews of which will be appearing in the next few months. If there are any avid readers who enjoy reviewing books, please contact Margaret in the Guild office, or Chris Portoghese, 645-7992, the Guild library chairman.

Chris needs workers to catalogue new books and periodicals, repair books, reshelve books, and make overdue reminders. Your help in that department will be appreciated, so watch for an announcement of weekly work periods.

Donations of books or money for books will be received gladly in the office. All donations are acknowledged with a bookplate stating the donor's name. We are fortunate already to have such a fine collection of books on all aspects of fiber arts. We welcome suggestions for new titles which we may have overlooked.

Kathie Frank

## BOOK REVIEWS

**Ikat Technique** Jackie Ballenfield (\$11.95)

At last! Here is a little book that tells you how to do warp and weft Ikat. Using clear diagrams, photographs and text the author leads the reader through the steps needed to prepare ikat. Brief sections on the history of ikat and contemporary uses of the technique are also offered for inspiration.

There is a section on the use of dyes which is very concise as far as it goes. Unfortunately, it deals only with the most common hot water dyes and ignores the use of fiber reactive dyes. It also fails to warn the reader about the possibility of fading in household or "union" dyes. There is information on discharge dyeing. The book is amply illustrated in black and white, but unfortunately, has only a few color illustrations, which is especially disappointing in a book devoted to a color-oriented topic. However, the lack of color keeps the price of this hard bound book within reason. It is well worth looking at for anyone interested in trying ikat.

**Four Harness Weaving** Kernochan Bowan (\$18.50)

This book is intended for the absolute novice at the floor loom. It covers in great detail, and with many illustration, all of the steps from warping to weaving. Information on the care and selection of looms is also included. The section on drafting covers reading a draft, how to do a draw down, and the effects of color changes in warp or weft; however, virtually nothing is said about the types of weaves. There are good sections on warp calculation but not much on design. There is also discussion of record keeping, volunteering, workshops, and other courses of study, and the advantages of Guild membership.

The scope of this large book is basically limited to the mechanics of using the four harness loom. It would be improved by an expanded section on drafting, and more well organized information on dealing with common mistakes. However, it would serve as an excellent text for the weaver who only warps up occasionally and needs a refresher.

Charlotte Miller

**Bolivian Tubular Edging and Crossed Warp Techniques**

by Adele Cahlander with illustrations by Marjorie Cason and Ann Houston, The Weavers Journal Monograph No. 1. \$3.00

The monograph is a collection of three articles written by Adele for the Weavers Journal on the intriguing crossed-warp weaves found in the decorative edgings that embellish Bolivian textiles. These bands have patterns and textures that resemble card weaving, but are produced by a series of leno-type crossings of the warp. Both flat and tubular bands can be made using the techniques described in the step-by-step instructions. The articles are enhanced by a series of excellent illustrations showing the steps involved in maneuvering the threads and the structure of the resulting fabric.

Karen Searle



**NATIVE ART TOURS**  
WINTER 1979  
WRITE - TERESA JOHNSON  
RFD IVANHOE, MN 56142  
OR CALL - 1-507-694-1437

**GUATEMALA - WEAVING, ARCHEOLOGY**  
**OAXACA - WEAVING, POTTERY, BASKETRY**  
**CENTRAL MEXICO - POTTERY, WEAVING**

# SCHOOL NEWS

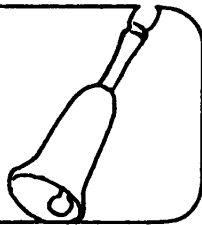

An exciting year of classes is now underway at the Weavers Guild School. By popular demand, scheduling has been expanded to include more evening and weekend classes.

Following is a summary of October and November classes. Check the class schedule for complete details. Schedules are available at the Guild office.

## WEEKEND WORKSHOPS

Fall is always a good time to begin projects and learn something new. Every weekend this fall affords an opportunity to gain experience in a wide range of fiber techniques. Many exciting possibilities are available to weavers of all levels. Register now for one or more of the weekend workshops.

### Fabric Design--Printing and Dyeing by Hand

Oct. 13-15 Fri. 6:00-10:00 p.m.  
Sat. 9:00 a.m.-3:00  
Sun. 12:00-5:00 p.m.  
Lynn Klein

### The Use of Color

Understanding the use of color is important in designing with fiber and fabric. This course is modeled after the color course Lynn taught at Quadna Lodge for the Summer Arts Study of the U of M.

Oct. 10-22 Fri. 6:00-10:00 p.m.  
Sat. 9:00 a.m.-3:00  
Sun. 12:00-5:00 p.m.  
Lynn Klein

### Weekend Floor Loom

Oct. 27-29 Fri. 6:00-10:00 p.m.  
Sat. 9:00-12:00 and  
1:00-4:00 p.m.  
Sun. 12:00-4:00 p.m.  
Char Miller

### Four Harness Double Weave

Double weave offers intriguing and limitless design potential. This is an opportunity for Guild weavers to take a workshop.

Nov. 3-5 Fri. 6:00-10:00p.m.  
Sat. 9:00 a.m.-12:00 and  
1:00-4:00 p.m.  
Sun. 12:00-5:00 p.m.  
Sue Baizerman

### Color and Pattern Effects

Nov. 4 Sat. 9:00-12:00 and 1:00-3:00  
Cathy Ingebretsen

### Weaving for Interiors

This is an opportunity for both frame and floor loom weavers to study design for interior spaces.

Nov 10-11 Fri 6:30-9:30 p.m.  
Sat 9:00 a.m.-12:00 and  
1:00-4:00 p.m.

Cathy Ingebretsen and Sue Obrestad

## CARD WEAVING

Explore the variety of possibilities unique to card weaving.

Nov. 11-12 Sat. 12:00-5:00 p.m.  
Sun. 12:00-5:00 p.m.  
Char Miller

## FRAME LOOM

### Intermediate Skills Using a Frame Loom

Sec 1 Tues Oct 31-Nov 28 9:00 a.m.-12:00 Karen Searle

Sec 2 Wed Nov 1-Dec 6 6:30-9:30 p.m. Cathy Ingebretsen

### Color and Design for Frame Loom Hangings

Tues Oct 31-Dec 5 7:00-9:00p.m. Pat Warner

### Lace and Open Work

This class is a weaving opportunity for floor looms as well as frame loom weavers. Experience countless adventures in lace and open work under the expert guidance of Mar Temple. This class is a weaving opportunity for floor loom as well as frame loom weavers. Experience countless adventures in lace and open work under the expert guidance of Mary Temple whose award winning fiber works are represented in commissions and collections, and have been shown in national invitational and juried exhibits, books, and magazines.

Tues Oct 31-Nov 21 7:00-9:00 p.m. Mary Temple

## SPINNING

### Beginning Spinning

Sec 1 Fri Oct 13-Nov 10 10:00 a.m.-12:00 Pat Boutin Wald

Sec 2 Mon Oct 16-Nov 13 7:00-9:00 p.m. Marcia Kozloff

## FLOOR LOOM

### Floor Loom I:

#### Introduction to Floor Loom Weaving

Sec 3 M,W Oct 30-Dec 4 6:30-9:30 p.m. Joy Rosner  
(no class Nov 22)

### Floor Loom II:

#### Intermediate Floor Loom Skills

M,W Oct 30-Nov 27 6:30-9:30 p.m. Sue Obrestad

### Coverlets

M,W Sept 27-Oct 23 7:00-9:00 p.m. Peggy Dokka

## TAPESTRY

### An Introduction to Tapestry

Sat Oct 7 9:00 a.m.-3:00 p.m. Alexandra Cervenka

### Tapestry: A Study in Depth

Wed Oct 18-Nov 15 9:00 a.m.-12:00 Alexandra Cervenka

## RELATED COURSES

### Finishes and Embellishments

Tues Oct 31-Nov 21 10:00 a.m.-12:00 Sue Baizerman

### Tatting

Tues Sept 26-Oct 24 7:00-9:00 p.m. Sue Mansfield

### Multiple Harness Backstrap Weaving

Tues Oct 10-Nov 14 6:30-9:00 p.m. Dianne Swanson

# THE MINNESOTA WEAVER

Editor.....Karen Searle  
Copy Editor.....Mary Skoy  
Guild Editor.....Suzette Bernard  
Education Editor.....Nancy Haley  
Shows & Exhibits Editor.....Suzy Sewell  
Swatch Page Editor.....Paul O'Connor  
Art Editor.....Dianne Swanson  
Typesetter.....Suzette Bernard  
Photographers.....Nancy Haley, Karen Searle  
Artists.....Barbara Fritzberg, Kathy McMaho  
Reporters & Columnists.....

Rose Allen, Debby Alper, Andrea Blue,  
Pat Boutin Wald, Kathie Frank, Barbara Fritzberg,  
Cathy Ingebretsen, Lis Jones, Connie Magoffin,  
Sue Obrestad, Joy Rosner, Bev Skoglund, Mary Temple

Office .....Phyllis Pladsen, Pam Prosser, Roberta Wurden  
Layout/Keylining ....Kathie Frank, Lynn Marquardt, Pam Prosser,  
Karen Searle



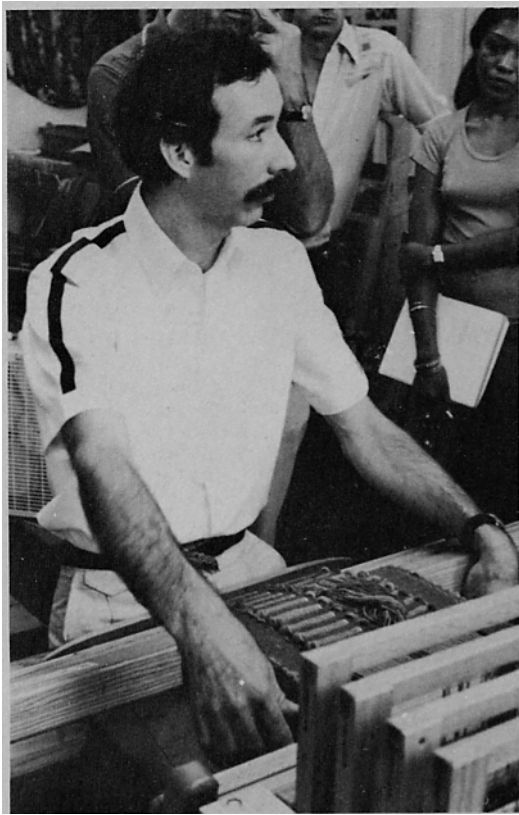

Ken Weaver and students during Rep weave workshop.

### Ken Weaver Workshop

I could sit and explain the process of warping a loom for rep weave, I could tell you the technical information we acquired, I could list the pieces of information I learned about weaving in general, but I am not going to do that. I am going to share with you some of my perceptions and feeling about the 17 persons who gathered in the Guild that hot week to participate in the Ken Weaver Workshop.

I perceived so much sharing of persons.

- the cooperation in holding five bundles of yarn as we worked on the warping boards
- the wonder of the explosion of colors as they became creations on the looms
- the sharing of common experiences and interests over quick lunches
- the acknowledging of what persons were dealing with as they started the workshop. We are not isolated islands; as mothers, wives, husbands, we make arrangements so we can be somewhat free to devote our energy exclusively to the wonderful task at hand. And yet there are circumstances over which we have no control. I was touched by the way these were shared and affirmed and then we were free to move on.....
- the joy shared over the news of a long awaited pregnancy

- the literary knowledge that exploded when someone mentioned C.S. Lewis..... a beautiful conversation about children's literature which reflects the love that enriches the lives of our children
- the expertise that was shared by Ken Weaver, our Artist Teacher. I particularly responded to his teaching style; his clearness and his soft spoken matter of factness, and one aspect of his philosophy of weaving. He hoped we would take the idea of working with one technique and expanding it into many different forms or variations. It could be with rep weave or any type of weaving we are doing.

So to all who were there  
Thank you!

Louise Cameron

### Presentations Workshop: Ken Weaver

Twenty-two weavers interested in learning more professional ways of showing their ideas to a client took the Ken Weaver workshop entitled *Developing Formal Presentations* on August 12-13. As we have come to expect with one of Ken's workshops, the wealth of information presented was impressive. I heard several people agree with me that Ken gives all that he knows to his students in the most generous fashion; he is not the type to hold back any secret ingredient, magic trick, or "pinch of salt". On Saturday Ken showed slides of his past and current work, lectured on procedures to follow in presentations, and had us work up three of four preliminary boards to the rest of the workshop group, and they acted as the board of directors to approve one of the sketches. This chosen sketch was then colored up to look as much like the final fiber piece as possible, and developed into a formal presentation board. Ken's background as an architect gives him the view points of both artist and client, and he believes it is most important that the client really see what the piece is going to look like when it is finished and hanging in its space. This presentation technique tends to eliminate, it is to be hoped, any nasty surprises such as the chairman of the board saying to the artist when the peice is finished: "Oh, is this what you meant! Well, it isn't what we thought you meant, and we don't like it!"

Mary Temple

### Our Advertisers This Month:

Beka Looms	14
Earthworks	5
Ewe & Me	5
House of Macrame	14
M. Susan Brock, Ltd.	12
Teresa Johnson	7
The Yarnery	11
Wool-N-Shop	2

# SPECIAL EVENTS

## KOREAN FIBER FORMS WORKSHOP

The University of Minnesota Design Department is offering a workshop on design and construction of Korean Fiber Forms. The workshop will be held on October 28 from 9:00 to 5:00, taught by Mrs. Kae Jung Kwak, a master of crafts from Korea. The workshop is labeled Design 5-585 *Problem in Design* and costs \$50.00. For more information or advance registration materials call the Design office (373-1032) or Charlene Burningham (373-1874).

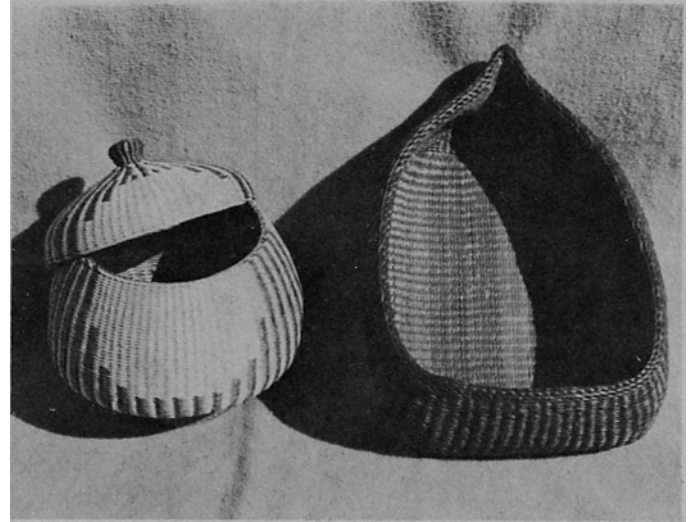

Double Weave baskets by Mrs. Kwak, courtesy of Pat O'Connor.

## LECTURE ON KOREAN FIBER FORMS

Mrs. Kae Jung Kwak, a master craftsperson from Korea, will give a public lecture and slide presentation on October 27 at 3:00 p.m. This free lecture will be held in Room 33 (the auditorium) of McNeal Hall on the St. Paul campus of the University of Minnesota. Mrs. Kwak's basketry show will be on display at that time in the Goldstein Gallery of McNeal Hall.

## GUATEMALA LECTURE

Sue and Mike Baizerman, recently returned from a five month stay in Guatemala, will give a slide lecture on their experiences on October 16, at 3:00 p.m. in MacNeal Hall on the St. Paul Campus of the University of Minnesota.

## GUILD PARKING

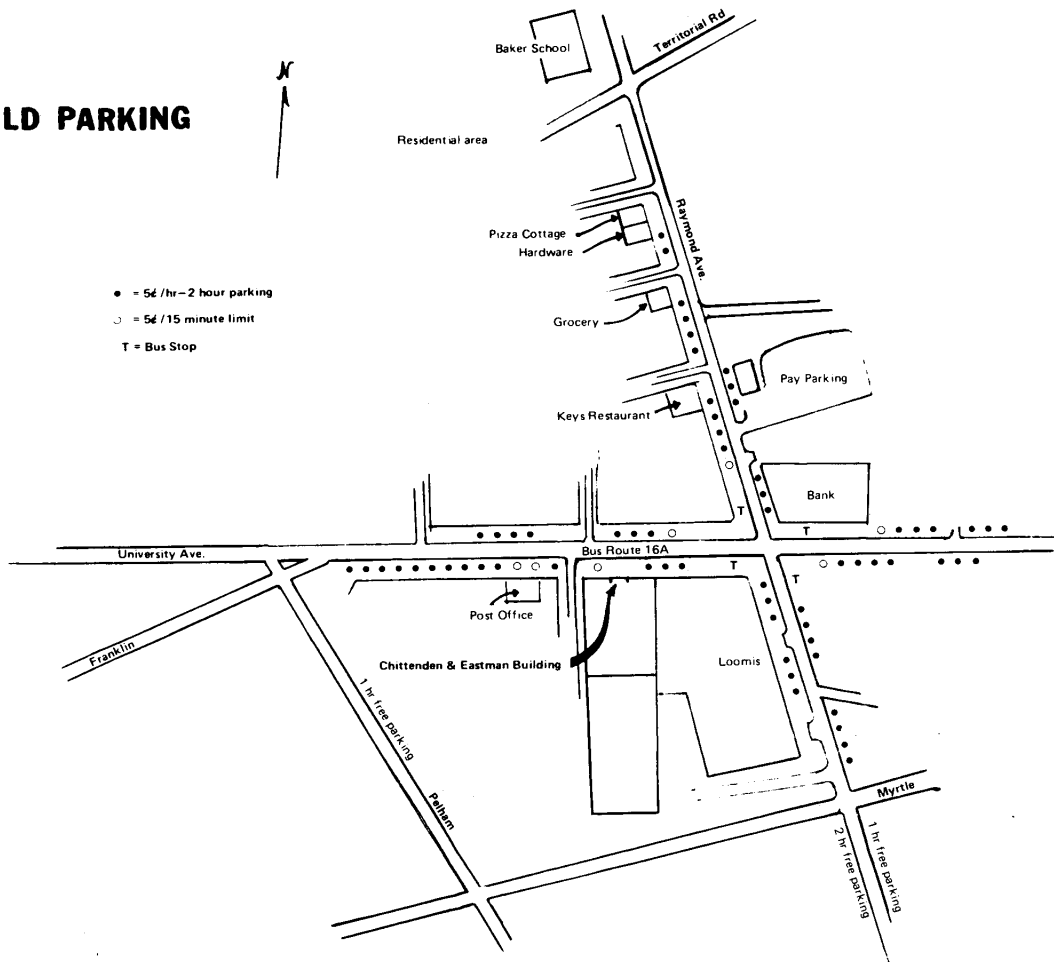

# SWATCH PAGE

## DOUBLE WEAVES WITH 4, 6 AND 8 HARNESES

by Paul O'Connor

I first became fascinated with double weaves when I saw the work of Richard Landis and Kay Sekimachi in "Beyond Craft: The Art Fabric." Although the severe geometrical patterns that Landis weaves are quite different in final effect from the lacy hangings done by Sekimachi in monofilament nylon, the weaving techniques are closely related. In this series of articles I will start with the fundamentals of weaving double layer materials with four harnesses and progress to six and eight harnesses. A rising shed loom (jack loom) will form the basis for all discussions.

Harriet Tidball's monograph #1 "The Double Weave: Plain and Patterned" is probably the best reference covering most aspects of double weave but I must confess that I find it difficult reading. Peter Collingwood discusses a variety of multilayer weaves for rugs in "The Techniques of Rug Weaving" and Mary Elizabeth Laughlin gives clear and detailed instructions for backed and double cloth in "More Than Four." And of course many of the standard books on weaving, for example Else Regensteiner or Mary Black, have sections on double weaves. But first let's look at the types of things that can be done with double weave.

### I. Double Weave Possibilities

Since two harnesses are required to weave one layer of cloth in plain weave, a loom with four harnesses can be used to weave two layers of cloth, each in plain weave. A six harness loom can be used to weave three layers; and with an eight harness loom, you can weave two layers with each layer having all the possibilities of four harness pattern weaves such as twills or overshot. But we are getting ahead of ourselves.

The separate layers of double weave can be interchanged from top to bottom to form pockets, to bend warp colors, or to create three dimensional forms. There are basically four different ways to treat the layers of cloth in double weave.

1. Two separate layers can be woven. These layers can be interchanged or stitched together (this usually requires more than four harnesses).
2. The two layers can be joined at one selvage to give a single cloth that opens up to twice the width when taken off the loom.
3. The two layers can be joined at both selvages to create a woven tube.
4. Using pickup techniques, the weaver can alternate top and bottom layers to create any pattern desired. The two layers are joined together by the technique into a single layer.

The first four articles in this series will treat each of these techniques separately and will offer some example of how they can be used in a variety of ways.

### II. Four Harness Double Weaves

#### A. Threading and Tieup

Straight draw twill threading is used for double weaves. Figure 1 shows the threading, with the top layer woven with harnesses 1 and 3 and the bottom layer with harnesses 2 and 4. The warp threads will be indicated by the corresponding harness number in these articles (although often the two sets of warp threads are indicated as light and dark). The sett for double weaves is usually twice that for weaving a single layer and two warp threads, an even and an odd, are drawn through the same dent of the reed. It may be convenient to use a more open reed and draw four or more threads through the same dent. This can reduce abrasion of warp threads and also makes it easier to change top and bottom warp threads when bending warp colors (see below). Just remember to have an equal number of even and odd numbered warp threads in each dent.

			4			4
HARNESS			3			3
#			2			2
			1			1

FIGURE 1. THREADING FOR DOUBLE WEAVE

Before tieups are discussed, we want to examine the weave structure for two separate layers. Figure 2 is a cross section through the two layers of warp threads. Two shuttles must be used. The first shuttle weaves warp threads 1 and 3, and the second shuttle weaves warp threads 2 and 4. The secret in double weave lies in realizing that the top layer(s) must be raised up out of the way when weaving the lower layer(s). This leads immediately to the tieup. In figure 3, the tieup for the top layer is given first. Next the tieup for the lower layer is shown in two parts to remind you that the top layer must be raised for each weft shot in the lower layer. These are put together into a single tieup diagram on the right side of the figure. (Later a skeleton tieup will be presented).

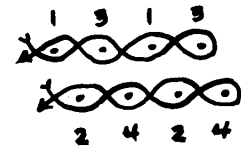

FIGURE 2. WEAVE STRUCTURE FOR TWO SEPARATE LAYERS

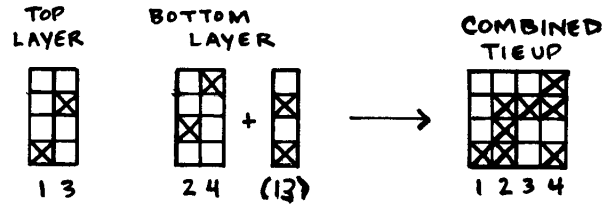

FIGURE 3. TREADLE TIEUP FOR 4-HARNESS DOUBLE WEAVE

### B. Weaving Two Separate Layers.

All that is needed to start weaving now is a treadle sequence. Two shuttles are required and it is usually best to alternate picks in the top and bottom layers so that the wefts are beaten evenly in each layer. You may have trouble getting good sheds for the first few weft shots but soon the two layers separate quite well. The treadling sequence follows the treadle numbers in regular fashion.

Treadle #	Shuttle #	Layer being woven
1	1	Top
2	2	Bottom
3	1	Top
4	2	Bottom

Repeat

That's all there is to it! (Excepting for correcting the weaving errors in the bottom layer after removing the piece from the loom). I have seen pictures where a mirror is attached to the loom to let you see the lower layer while weaving but I have not had much success spotting errors using a mirror. Don't forget that you can do all the variations of warp and weft colors and textures in each layer that you can do with two harness weaving.

I want to finish this first article with a discussion of interchanging warp threads so that the top layer becomes the bottom layer and vice versa. This ties the two layers into a single cloth. The photograph shows a double woven sampler with warp threads in yellow and gray, arranged in stripes in the warp. The weft thread is gray for each layer. A type of checkerboard pattern results when the two layers are interchanged. The tieup must be changed so that the warp threads 2 and 4 become the top layer and warp threads 1 and 3 become the bottom layer.

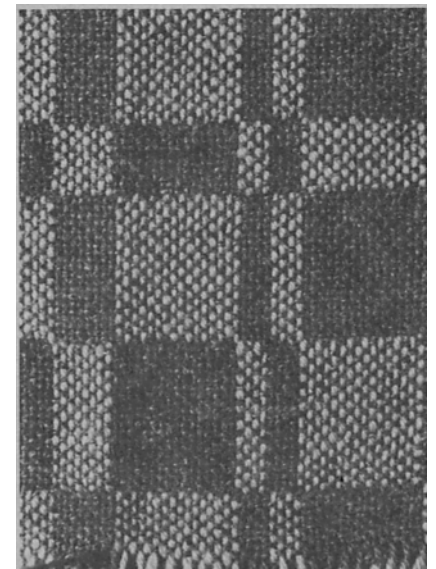

FIGURE 4. TIEUP CHANGE TO INTERCHANGE WARP LAYERS

Figure 4 shows the original tieup and the new tieup side so that you can see what the difference is. The treadling sequence remains the same as before. But now it is time to introduce you to a skeleton tieup that is quite easy to use for a four harness loom. Since four harness looms have six treadles, we can tie up the treadles as shown in Figure 5. The two tabby tieups are on the outside and four single tieups are in the corner. You will have to use both feet in treadling. The treadling sequence is given for each layer on top.

warp 13 top layer warp 24 bottom layer		warp 24 top layer warp 13 bottom layer	
Treadle #	Shuttle #	Treadle #	Shuttle #
1	1	2	1
2 + a	2	1 + b	2
3	1	4	1
4 + a	2	3 + b	2

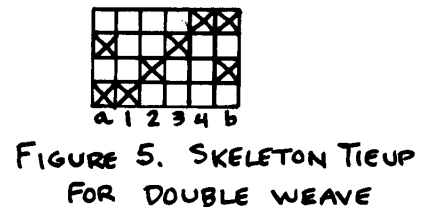
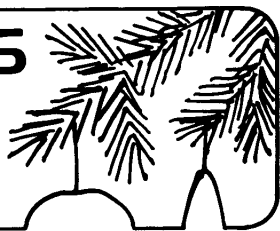

FIGURE 5. SKELETON TIEUP FOR DOUBLE WEAVE

One last point. You can close each selvage by crossing the weft threads for the two shuttles as you weave.

The next article in this series will discuss some more possibilities in weaving two layers and then of on to discuss weaving double width fabrics.

# CHRISTMAS TREE



Hurrah, it's only October and we are almost done. We have all the tubes and cones we need to finish the colored ornaments, now we need to work on them. We will be having two more workshops during the month of October: Tuesday the 17th from 7:00 to 9:00 at the Guild, and Wednesday the 25th from 9:30 to 2:00 at Mary B. Johnson's home, 1510 Edgcumbe Road, St. Paul-bring a bag lunch, we will furnish dessert and coffee.

Attention Crocheters: we need you! We're short on snowflakes and really need some help in this area. There are several dedicated people making some at home but we could use many more. Use the following pattern, and "O" steel crochet hook, and white Speed Cro-Sheen and you will have the size we need. Larger ones are okay, too. If you have a favorite pattern from some other source, please feel free to use it.

Attention Tatters: a couple of the new crafts magazines on the newstands have include tatted snowflake patterns--so indulge yourself (and us) and make some for the Guild!

Dianne Swanson

## Crocheted Snowflakes

Materials: white speed cro-sheen steel hook size O

Directions:

Ch 5, join with a sl st to form a ring.

Rnd 2: Ch 8, \*make a tr cluster as follows: holding the last loop of each tr on hook, make 3 tr in 4th ch from hook, yarn over and draw through all 4 loops at once, tr cluster made. Tr in ring, ch 4; repeat from \*4 times, make a tr cluster, sl st in 4th ch of beg ch.

Rnd 2: Ch 7, so into 3rd ch of cluster, ch 3, tr into tr between clusters, ch 1, \*tr into same tr, ch 3, sc, sc into 3rd st of cluster, ch 3, tr into tr of previous row, ch 1. Repeat from \*4 more times. S1 st in 3rd ch at beginning of round 2.

Rnd 3: Sc into ch loop, ch 7 sc into next ch loop, 2 sc into ch-1 space, \*(sc into next oh loop, ch 7, sc into next ch loop, 2 sc in ch-1 space). Repeat 4 more time from \*.

Rnd 4: \*Ch 5, sc into 2nd ch st of previous row, ch 5, sc into 2nd ch from hook; sc in next ch; ch 2; skip 2 chain in previous row, sc in next ch; ch 5; sc in 2nd ch of previous row, sc in next sc. Repeat from \* 5 more times, join with sl st. End off.

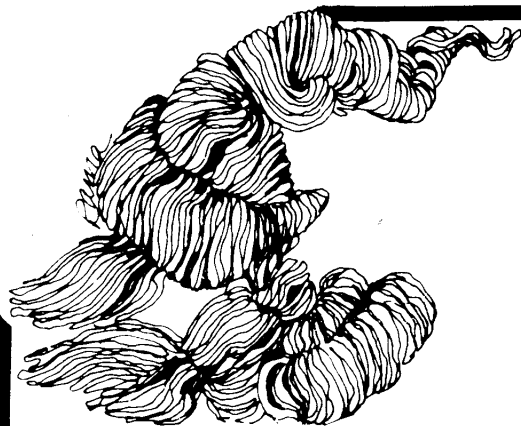

# the Yarnery

with this ad ----

## 10 % off Cum weaving yarns

## during October

1648 Grand Avenue, St. Paul 690-0211

Rosedale Shopping Center, Roseville 631-2800

Leisure Lane Shopping Center, Edina 922-7179

# FROM WOODS & FIELDS

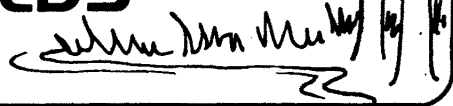

by Connie Magoffin

Fred Gerber has written a new 70-page book entitled, *Cochineal and the Insect Dyes*. In the past a lot has been written about cochineal, but of the sources available to me, Mr. Gerber has offered much more, including both historical and practical information. The first part of the book begins with a brief historical overview of dyes and mordants. Then follows a discussion of the insect dyes including kermes, St. John's Blood, lac and, finally, a detailed look at cochineal.

In the middle of the book is a colorful insert upon which is mounted 34 different yarn samples dyed with cochineal, each representing a different mordant, a combination of mordants, different modifiers (particularly different acids) or different exhaust baths. Gerber continues with a review of Bancroft's detailed study of cochineal which was begun in 1786. He also explains the difference between unmodified cochineal and carmine cochineal and how you can make your own carmine cochineal.

The next section of the book I was very happy to read. I have long looked for a practical color notation

system to use for recording my dye sample colors. Gerber suggests a new one to me, the ISCC-NBS Color Name Charts Illustrated with Centroid Colors from the National Bureau of Standards, Washington, D.C. He uses it to notate his cochineal studies and I plan to explore its possibilities. It would be nice if we could have a common terminology of color.

Gerber spends 10 pages explaining his series of cochineal experiments and making observations on the results. It is frustrating that not all of the experiments he discusses are included in the yarn samples, however, the 34 he does include are more than generous and they are extremely helpful in suggesting the enormous color potential of cochineal. The book is concluded and on the last page Mr. Gerber offers a question for modern dye experts to answer concerning the antiquity of the use of cochineal on the old world. Fred Gerber's book gave me a new understanding of a traditional dye-stuff and opened new avenues for exploration with cochineal. He has also done such extensive personal experimentation, Mr. Gerber offers insights you seldom find in current dyebooks.

Anyone who dyes with cochineal should have this book. If you are interested, write Gerber Publications And The Arachnid, P.O. Box 1355, Ormond Beach, Florida 32074. The book is \$6.75, plus postage, however, he offers a 40% discount for 6 or more copies (if several of you want to get together). The postage for 3 books or less is \$.50.

## Glimåkra Looms.

From four harness

to Damask Looms.

Steady, Sturdy, Swedish.

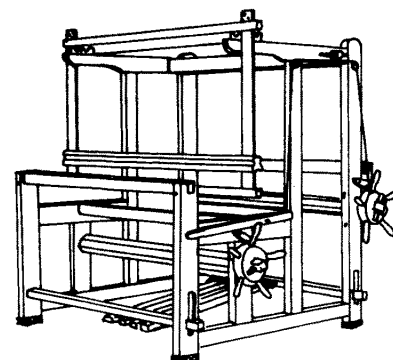

*M. Susan Brock Ltd.*

1838 St. Clair Ave.

St. Paul, Minnesota 55105

tel. 612/699-1909

# AS THE WHEEL TURNS

by Pat Boutin Wald

Handspinning on a spindle can be broken down into two main steps: first- drafting and twisting of the yarn onto the spindle shaft. One advantage of the spinning wheel is that these two steps take place simultaneously..

"Draw mechanism" refers to the system by which yarn is drawn onto the spinning wheel bobbin. There are three basic draw mechanisms: that of the double banded wheel, by far the most common draw system on antique wheels; scotch tension made famous by the Ashford wheel; and the tension system found on many bulk spinners that I refer to as indian head tension.

Before beginning to read the descriptions of how the different draw mechanisms work, you might want to look over the illustrations and familiarize yourself with the names of different parts of the flyer assembly.

## Double Banded Draw Mechanism

Wheels using this draw system are often called two banded or double banded although one continuous cord drives both the bobbin and the flyer. The drive band is a figure "8" folded back upon itself (figure 1). When the drive wheel is turned, the same length of cord passes over both the pulley on the far end of the bobbin (figure 2) and the pulley screwed onto the shaft of the flyer (figure 3). The revolving bobbin and flyer put twist into the fiber. You are drafting the fiber, and the wheel (propelled by your foot) is supplying the twist.

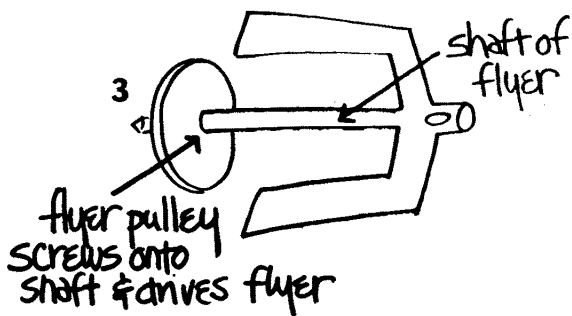
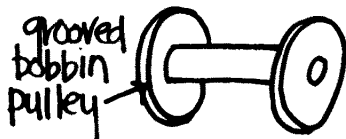

The diameter of the bobbin pulley is usually less than the diameter of the flyer pulley. The bobbin rides freely on the shaft of the flyer so the bobbin and flyer can revolve at different speeds. The bobbin

pulley and larger flyer pulley are rotated by the same length of drive cord, therefore the bobbin will revolve more frequently than the flyer. (Imagine one large wheel and one small wheel rolling down a hill. The small wheel will have to revolve more times than the larger to reach the bottom of the hill.) The faster rotation causes the yarn to be drawn in and wrapped around the bobbin spool (figure 4). The greater the difference between the size of the pulleys, the faster the yarn is drawn in. The relationship of the two pulley sizes is referred to as a "ratio" (figure 5).

## 4 the flyer assembly

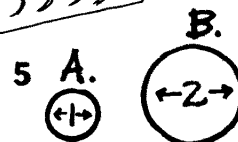
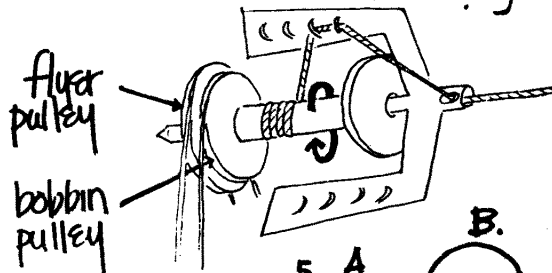

ratio of A. to B. = 1:2

A pulley if driven by same length cord as B. pulley will revolve twice as fast.

The pulleys will slip against the drive cord if it is very loose, or if you hold back on the yarn while spinning. The more you tighten the drive cord, the less slippage and greater the strength of draw.

A large wooded screw is a very common tension control on antique wheels. The screw can move the flyer assemble farther away from the drive wheel for increasing tension on the drive band. When turned the opposite direction, it moves the flyer closer to the drive wheel, decreasing tension. Figure 6 shows the directions the flyer moves in relation to the drive wheel for (A) castle wheel and (B) a saxony style wheel.

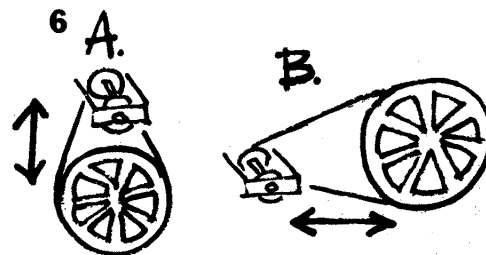

next month

draw mechanisms on scotch tension and indian head spinners

I'd like to express my thanks to Michael Bayer (Seattle) for first explaining to me how spinning wheels work and to Tony and Vlasta Blaha Glaski for their help in defining technical terms.

# FIBER FAIR

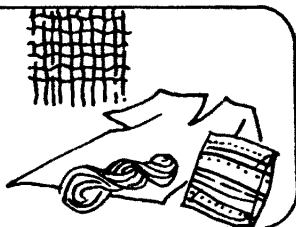

## FIBER FAIR '78 IS COMING!

Mark your calendar now for this year's Fiber Fair sale to be held at the Guild November 16 - 19.

Whether you are fresh from a beginners class or have been weaving for years, we are looking forward to seeing your work at this year's Fiber Fair. This is an excellent opportunity for Guild members to sell their well-crafted, designed and finished fiber pieces.

The entry fee will be \$3.00 and the Guild will receive 15% of all sales. The entry fee will be used for publicity, printing tags, receipt books, and other miscellaneous expenses. The 15% will go to the Guild.

Entry blanks are included in this issue. Upon receipt of the entry blank, each entrant will receive a page of guideline, an entry form and Guild tags. If more tags are needed, they can be picked up at the Guild office.

The deadline for entries is October 31. All entrants will be required to work on the Fair in some way. We need your help to make this fair possible. All new entrants and anyone with questions about their pieces (finishing, hanging, etc.) must show their items to the Selection Committee on October 18 or 19. All entries will be subject to review at check-in.

The Fiber Committee:

Elaine Phillips, Coordinator  
Kathy Martin, Kathy McMahon, Irene Meyers,  
Finance  
Mary Temple, Pat Peshorn, Selection  
Linda Summerfield, Staging  
Mary B. Johnson, Publicity

## A WORD FROM THE FIBER FAIR SELECTION COMMITTEE

All articles to be sold at the Fiber Fair will have to meet the Selection Committee Guidelines, which will be available at the October 5 Guild meeting. All pieces will be viewed by the Selection Committee during Check-in on November 13. If you feel that an article that you will be selling should vary from the guidelines, please bring it, or have a friend bring it, to the early meetings of the committee. These meetings are for new Fiber Fair participants and for those who have questions about their items. They will be held at the Guild on Wednesday, October 18, from 7-9 p.m., and Thursday, October 19, from 1-3 p.m.

Sturdy labels for weavers name, washing instructions, etc., must be supplied by the weaver. The Guild tag will be for pricing and identification number only. Members from the selection Committee will be at the October 5 Guild meeting to answer questions and hand out guidelines for standards.

### Props Needed

Display racks and props are needed by The Staging Committee for display of items. Please bring your extra hat racks, coat racks, etc. to the Guild.

# CIBA DYES

*House of  
Macrame*

5416 Penn Ave. So.  
927-8307

# Beka Looms

THINK BEKA FOR BACKSTRAP

for free catalogue write: Beka Inc. 1648 Grand Ave. St. Paul, Mn. 55105 (612) 222-7005



## FIBER FAIR ENTRY FORM

Name \_\_\_\_\_ Address \_\_\_\_\_

City \_\_\_\_\_ State \_\_\_\_\_ Zip Code \_\_\_\_\_ Phone \_\_\_\_\_

All participants will be required to work on one of the following committees or for a 3-hour shift during the fair. Please check one. If for some reason you cannot work one of these into your schedule, please check "other." We have many small tasks that you can help with.

Committees: Publicity \_\_\_\_\_ Sale work days: Friday, November 18 \_\_\_\_\_  
Finance \_\_\_\_\_ Saturday, November 19 \_\_\_\_\_  
Personnel \_\_\_\_\_  
Staging \_\_\_\_\_  
Selection \_\_\_\_\_  
Other \_\_\_\_\_

Enclosed is my entry fee of \$3.00 Make checks payable to the Weavers Guild of Minnesota.

Non-members may enclose a separate check for \$15.00 Guild membership Members — please check to see if your membership is current.

Complete the above form and mail to: The Weavers Guild  
427½ Cedar Avenue  
Mpls, MN 55454

**DEADLINE IS OCTOBER 31**

### BULLETIN BOARD

#### ANNOUNCEMENTS



#### SALES OUTLET FOR WEAVERS

Ann Scher announces the opening of The Endless Thread, a consignment sales outlet for weavers in The Market House, 653 Grand Avenue, St. Paul.

In addition to providing a retail outlet for handwoven goods, Ms. Scher will also provide a slide referral service as a means of displaying large pieces to interested architects and interior decorators. A finishing service is also available to persons who lack the time or skill to turn their weavings into finished items. For more information, call her at 224-8535.

#### Notice:

The Guild cordially invites study groups to make use of the new Guild Facilities. Check with the office about room availability.

#### STUDY GROUP WILL HOLD SALE

Prospect Park Weavers Study Group will hold their 4th annual Mostly Weaving Sale of handwoven goods and pottery Saturday, October 7 from 10 to 4 and Sunday, October 8 from 1 to 4 at the Bratt's home: 201 Cecil Street S.E., Minneapolis. Turn south off Franklin Avenue S.E. 3 blocks west of Highway 280.

#### STUDY GROUP INVITES MEMBERS

Prospect Park Weavers would welcome new members from Southeast Minneapolis to their weekly study group. The evening sessions are devoted to sharing information, winding warps, finishing projects, inkle weaving, and ordering bulk yarn for group discounts. At least one morning each month is spent natural dyeing. For more information, or to attend, please call Judy Bratt, 379-7261.

#### VOLUNTEER OPPORTUNITIES

##### for weavers, spinners, and dyers

The new Science Museum of Minnesota is opening its facility to the public on September 19. In this facility is a weaving area, a spinning and fiber area and a wonderful hearth for dyeing fibers. Volunteers are needed for this exciting new facility to conduct educational programs for visitors. Use your skills in a unique new environment. For further information call 221-9443 Karla-McGray or 221-9446 Lois Bohon.

#### ATTENTION FLOOR LOOM WEAVERS

The Guild has an information sheet on the care of looms. This will be demonstrated at the October 5th meeting. If you cannot attend the meeting, the sheets will be available at the Guild office for ten cents.

#### WANTED

Ideas and/or examples of fiber holiday trims and ornaments to be used for a November workshop "Holiday Trims." If you have anything you are willing to share, contact Dianne Swanson, 483-5151.

# THE MINNESOTA WEAVER

Published monthly except July, August, and December  
Weavers Guild of Minnesota

The Weavers Guild of Minnesota  
2402 University Avenue  
St. Paul, Minnesota Mary St  
644-3594

NON PROFIT ORG.  
U.S. POSTAGE  
PAID  
PERMIT NO. 2963  
MPLS., MINN.

## DATES TO REMEMBER

October 5 1:00 p.m. and 7:00 p.m. October Meeting  
and Open House

October 12 9:30 a.m. Board meeting

October 17 7:00 p.m. MIA Tree Trims Workshop

October 19 7:00 p.m. Handwoven fashion show organ-  
izational meeting

October 25 9:30-2:00 p.m. MIA Tree Trims Workshop  
at the home of Mary B.  
Johnson, 1510 Edgcombe  
St. Paul, bring a bag lunch.

November 2 7:00 p.m. November meeting

November 9 9:30 a.m. Board meeting

For details see "COMING UP" on page 1.



Photos by Nancy Haley

