

# THE MINNESOTA WEAVER

Vol. 4, No. 4 December - January 1978-79

**COMING  
UP**

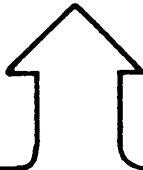

## DECEMBER PROGRAM

**Thursday, December 7, 1:00-3:00 p.m.**

### Science Museum Tour

Weavers Guild members will have a chance to tour the new Science Museum of Minnesota after a brief meeting and description of how the Peruvian Textile exhibit at the new museum was set up. Sue Baizerman, Suzy Sewell and Karen Searle will be your hostess/guides.

Meet in the auditorium of the old Museum building, 30 East 10th St., ground floor, at 1:00.

More information on what you can expect to see when you visit the museum appears below.

## JANUARY BY MEMBER FOR MEMBER WORKSHOP

**Thursday January 18, 9:30-12:00**

Yarn: Characteristics, uses, sett and additional topics. This workshop will involve the participation of the Yarn Committee and others. Please reserve a place one week in advance by calling the office. Limit: 20.

## JANUARY "EXTRA"

### COVERLETS CLASSES REUNION

January 4, 1979, all day starting at 9:30 a.m.

Ken Colwell, from Mineral Point, Wisconsin will speak, and bring his slides and a few unusual coverlets for us to see. He will also talk about the Ahrens-Violette dobbie loom. All who are interested are welcome to come. Please bring your own coverlet collection—both old and the new ones you have woven.

It is essential to make reservations in advance if you are interested in attending this program and have not attended one of the coverlets classes. Use the reservation blank provided elsewhere in this issue.

## FEBRUARY MEETING:

### PRESERVATION OF EXHIBITION TEXTILES

**Thursday, February 1, 1:00-3:00 p.m.**

Lotus Stack, our speaker, is coordinator of textiles at the Minneapolis Institute of Art. She has been involved in organizing the collection and cataloging of pieces, among many other activities. At present, Lotus is doing three, three-week stints at the Metropolitan Museum in New York, in the area of textile preservation. In the future, she hopes to obtain funding to undertake the cleaning of the European tapestry collection at the Institute.

Lotus will share some of her ever-increasing knowledge in the field of textile preservation with members on February 1.

## TENTATIVE SCHEDULE OF PROGRAMS FOR BY-MEMBER-FOR-MEMBER WORKSHOPS

**Nov. 30:** Weaving Moebius strips on a triangular loom. Paul O'Connor. (Participants will make the loom and begin weaving during the workshop.)

**Dec.:** No program.

**Jan. 18:** Program on yarns.

**Feb. 17 (Sat.):** Body ornaments and jewelry. Jean Lodge and Betty Olson.

**March:** St. Paul Arts and Science Museum, particularly the Navajo rug collection. (This program to be led by Jan Carter depends on the museum granting approval to see the rug collection which is tied up by the probate court).

**April:** Finishes and Embellishments. Sue Baizerman and Karen Searle.

**May:** A trip to Betty Olson's mother's home, about 35 miles. To see how she winds 100 yard warps, etc.



## NEW SCIENCE MUSEUM EXHIBITS OFFER MULTI-SENSORY EXPERIENCE

A multi-sensory experience is in store for those who visit the new Science Museum of Minnesota. Exhibit programs in the new building give visitors the opportunity to hear the sounds and rhythms of musical instruments from around the world, taste food from a Mayan market, shell corn by hand and weave on a backstrap loom.

The initial exhibit areas in the new building, at 505 Wabasha St. in downtown St. Paul, have been designed to show how various societies have dealt with the universal problems of food, clothing, shelter and energy.

The cultures represented in the exhibits range from the great civilizations, such as Egypt and the Maya, to the village traditions of the Ojibwa, Santee Sioux, Navajo and native Northwest Coast Indians.

The exhibit areas are titled: "Hearth," "Harvest," "Weaving," "Myths, Masks and Music," "Hunters and Gatherers" and "The Majesty That Is Maya."

The "Hearth" area deals with natural dyes and natural colors. Museum staff present demonstrations on dyeing fabric using turmeric, madder, woad, onion skins and coffee grounds. Dyeing with indigo is done by museum visitors on a daily basis. A huge natural dye recipe book which describes the history of different dyes, their geographical origins and cultural uses is on display.

The "Harvest" area compares types of grains grown today with those domesticated and grown by the American Indian.

The "Weaving" area focuses on weaving as an art form and the age-old technologies of producing cloth. The exhibit features textiles and looms from several cultural traditions. Navajo blankets, Pre-Colombian/Peruvian textiles and contemporary Mayan huipiles (blouses) woven and brocaded on backstrap looms are also on display. A seven-foot-high "People's Loom" is used to teach the fundamentals of weaving.

The "Myths, Masks and Music" area deals with symbolic artistic expression. Visitors learn to write their name in Egyptian hieroglyphics and play musical instruments from various parts of the world. Masks and totemic carvings of the native Northwest Coast Indians are displayed. Dramatizations are presented also.

The "Hunters and Gatherers" area includes an exhibit on the Fox Lake culture of southwestern Minnesota. A stylized hut serves as the context for displays of prehistoric tools, ceramics and hunting equipment.

"The Majesty That Is Maya" provides an in-depth look at the rich Mayan culture of Central America. A full-scale replica of a traditional Mayan dwelling serves as an ethnic classroom for programs on the daily life and ritual of the Maya Indians of Chiapas in southeastern Mexico.



### GUILD OFFICERS

President ..... Joy Rosner, 824-7045  
President Elect ..... Lindy Westgard, 644-6886  
Vice President ..... Edis Risser, 922-6596  
Secretary ..... Ruth Arnold, 544-0779  
Treasurer ..... Patricia McHugh, 922-9500  
Member Affairs Director ..... Marjorie Jirousek, 925-2296  
Outreach Director ..... Irene Wood, 831-1126  
Education Director ..... Nancy Haley, 644-0811  
Past President ..... Helen van den Berg, 377-4721  
Past President ..... Susań Obrestad, 777-2657

### Office Staff

Guild Coordinator ..... Suzette Bernard, 644-0263  
Office Manager ..... Margarte Pidde, 644-3594

### Office Hours

9:00 a.m.-3:00 p.m. 6:30-8 p.m. Weekdays  
9:00 a.m.-12:00 noon, Saturday

**Please note that there will be no evening office hours during December and January.**

---

### Summary of the Board meeting

#### October 12, 1978

The Yarn Committee reported on their sales and requested \$50 for expenses for continuing to maintain the yarn sample files.

The Fiber Fair will be well publicized by posters, mailings, ads and TV/radio presentations. The Board continues to support the policy: "The Fiber Fair sale is to be restricted to members' own work and invited guest artists."

Ann Scher from The Endless Thread told the Board about her weaving consignment shop.

The policy will continue of not giving out individual business cards for store discounts; students may request a receipt from the office to present to stores giving discounts.

Members and students will be receiving questionnaires; the results will aid in setting priorities at the long range goals meeting in January.

Irene Wood has invited Ken Colwell of At the Looms, Mineral Point, Wisconsin, for a Coverlet Day, January 4, 1979, 9:30 a.m.; he will bring coverlets and slides. Members' coverlets will also be displayed. Reservations requested.

A draw loom may be given to the Guild.

Craft Connection will be on sale in the office; proceeds go to the Guild.

The Guild has a copy machine; Margaret or Suzette may be requested to make copies; copies are 10¢.

Ruth Arnold, Secretary



## SUMMARY OF THE BOARD MEETING, Nov. 9, 1978

A non-discriminatory policy statement was formally adopted.

1. Evening office staffing is difficult and expensive:  
a. Evening classes will be asked to share the responsibility of answering the door and phone.
2. A telephone answering and message taking machine may be considered as an alternative to evening and holiday hour office staffing.

The yarn committee's quest for a \$50 budget to maintain yarn files was granted.

Discussion was introduced concerning the outside use of the Guild's mailing list.

The WGM Dye Garden project was granted supporting funds equal to 15% of the group's proceeds from their fiber fair sale items.

Books currently in print will be removed from the locked cabinet in the Library and placed in circulation.

Doors are being donated for the Dye Lab and *The Minnesota Weaver* office.

Suggestions were made for establishing a referral list of weavers who sell or work on commission.

Plans were initiated for the Weavers Guild's Fortieth Anniversary Celebration in March of 1980 to include a Juried Exhibition.

Next Board Meeting: December 14, 9:30 a.m.

## YARN COMMITTEE NOTE

Because the December meeting will not be held at the Guild, sales of the next Knight's yarn order will begin at the Guild as soon as it is put out. You can purchase yarn during regular Guild hours.

## PRACTICAL WEAVING SUGGESTIONS ARTICLE BY MINNESOTAN

Former Guild member, Luvan Troendle sent the Guild a copy of the Summer 1978 magazine **Practical Weaving Suggestions**, published by Lily Mills, which contains an article about her overshot placemats. Mrs. Troendle writes "For several years I was a member of your Guild and I can truly say that most of what I know about weaving came from the friendly and expert help from those wonderful weavers. While I am very proud of the article in the publication...I must give credit to those who helped me. Weavers like Hilma Berglund, Miss Linnie Thompson, Inez Pohland, Mabel Massie, Faithe Nunnely, Irene Wood, Irene Meyers, Anna Smits — the list goes on and on, and so do the memories. Thanks to you all very much."

## MEMBERS IN THE NEWS

The November issue of Mpls-St. Paul Magazine carries a full page article with color photos on the work of Cathy Ingebretsen on page 62.

The December issue of the Lutheran Bond Magazine has published an article on the Liturgical weaving of Joyce Karter of Kensington, Minnesota.

Lancy and Greg Haley were featured in the October issue of the St. Anthony Park Bugle. A multiple portrait of Sue Baizerman's son, Ari, was on the cover of that same issue.

# GUILD COORDINATOR

## NO EVENING HOURS AT THE GUILD

From now through mid-January, the Guild will not be staffed during the evening hours. If you want to use the Guild at some time other than Monday through Friday, 9:00-3:00 or Saturday, 9:00-noon, please call the office to make special arrangements.

## HOLIDAY CLOSINGS

Also note that the Guild will be closed December 22 through 26, and December 30 through January 1.

## Gift Certificates

Looking for that perfect gift for someone? "Give the Guild" gift certificates are available (year 'round, too) for memberships and/or tuition. They are available during daytime office hours or by special arrangement with Margaret or myself.

And remember our little "giftshop" counter, too, for that last minute present.

## Craft Connection For Sale

The WGM now carries Craft Connection so buy your next copy here. You'll be supporting **two** organizations with one action!

And...

If you have any energy left over after the holidays, why not join a Guild committee. It's **your** Guild so why not participate and help in the decision-making process. This is your chance to be heard!

Have a good holiday season. See you at the Guild in '79.

Suzette Bernard



wool-n-shop  
101 27th ave. s.e.

fiber, tools and books  
for handspinners

100% wool yarn, fabric and clothing

## NOVEMBER MEETING REPORT

Many thanks to Marj Pohlman for the excellent November Program, "Fabric as Symbol." Those of us who were able to attend enjoyed a very interesting and informative evening.

Using two slide projectors simultaneously, Marj showed us a close-up and an overall view of religious textiles, while she discussed liturgical design considerations.

It was a very well organized presentation of a topic to which Marj contributed her invaluable personal experience as well as extensive research and photography.

The following list, taken from my notes, may be of interest to some of you.

### Design Considerations:

- Space . . . Time . . . Scale . . . The People . . .
- Consider outside, as well as inside the building
- The need to balance Simplicity versus Complexity
- The design needs to work in the style of the space  
Sometimes architectural shapes are repeated in woven shapes  
Fabrics and lights can be combined for shadow effects  
Color, texture and shape can be used rather than graphic imagery to contrast to the building's imagery  
Unusual shapes of some altars necessitate alternative methods in altar coverings
- Consider the amount of "carrying power" your piece will have—how will it "read" from a long distance?  
Does it need to be two sided? (ie. carrying banner. . .)
- Consider whether this is a temporary or a permanent piece  
What is the practicality of any carrying, removal, or storage of the piece?  
Often, if you group panels together, they'll be stronger than if they are separate
- Where are you trying to focus the attention? usually on the main space

### 2. Garment considerations:

- The back of a garment may be designed with a broad pattern to show from a distance, while the front may be more intricate in pattern for communion intricacy
- Impact of "sensationalism"
- Color symbolism  
white - Christ (also yellow)  
red - Pentecost, Saints, Holy Spirit  
purple - Lent and Advent  
green - other times
- The Human Environment  
Historical background of liturgical garments  
Clothing to indicate rank  
Roman robe heritage—in many Christian Churches (Christ's robes)
- Consider the person who will be wearing the garment  
Size, shape, personality

### 3. Other considerations:

- You can design group projects that can get the congregation involved in their production
- Ceremonial installations of altar cloths, etc. can also get the people you're working with involved with the pieces

These are some of the points Marge elaborated on and are well worth our consideration. Thanks again Marj!

Cathy Ingebretsen

### CORRECTION

This picture was inadvertently printed upside down in last month's *Minnesota Weaver*. Our apologies to Marj. Here is how it really looks.

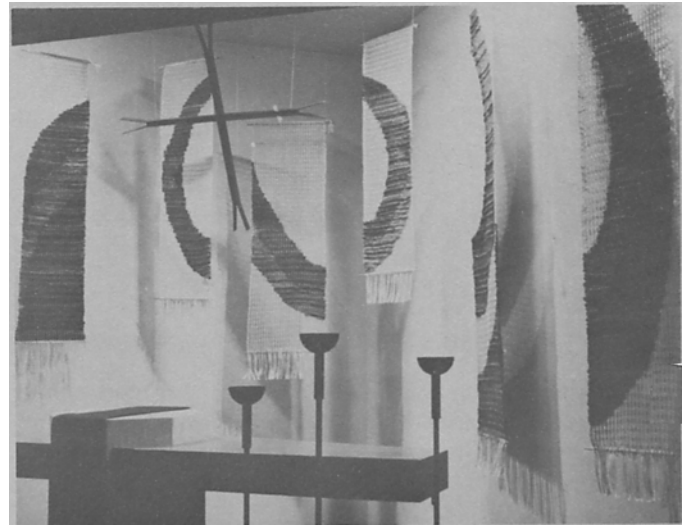

Fiber mural for the chapel at Zumbro Lutheran Church, Rochester, Minnesota, by Marjorie Pohlmann



### CONGRATULATIONS TO US!

Thanks to the cooperation of Guild members we made about 400 ornaments over the course of the summer and early fall. By the time you receive this *Weaver* the tree will be decorated and on display in the rotunda of the old section of the Minneapolis Institute of Arts. It's really been enjoyable chairing this committee—I highly recommend it to everyone. I met a lot of nice people I might not have at a crowded Guild meeting. Thanks again to everyone who contributed ornaments and participated in decorating the tree.

Dianne Swanson

# INTRODUCING

## NEW BOARD MEMBERS

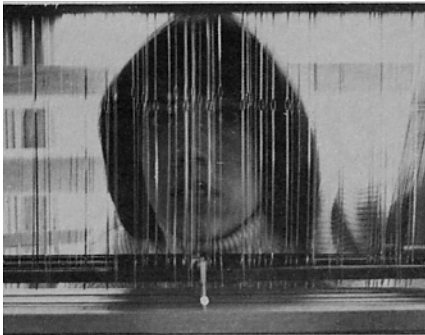

### Education Director

Nancy Haley: her name is synonymous with energy, imagination, and hard work. Practically from the time she joined the Guild, Nancy has been a very active member. From 1973 to 1974 she served as the Guild's secretary and was active in the move to Cedar-Riverside. Then she joined the Education Committee, becoming its chairman in 1977. Under her leadership, this committee made recommendations of long range goals, some realistic, some ambitious, for the Guild for the next ten years. Now Nancy holds the Guild's Education Director seat on the Board.

Born and raised in South Dakota, Nancy attributes her interest in weaving to the fascinating collection of native American beadwork she saw as a child in the Rapid City Museum. She taught herself the traditional Sioux geometric beadwork patterns as a junior high school student and continued this interest through college. While she studied for her degree in Education at the University of Minnesota, she taught South Minneapolis students to beadweave in community education classes.

After one frame loom lesson when she finished college, Nancy taught herself a number of weaves. Then she discovered the Guild a few blocks from her home. It was Marjorie Cason's program on Bolivian Weaving at the Guild which finally caught Nancy's fancy and led to her first formal class in weaving: Bolivian in 1972. She has actively continued Bolivian weaving ever since, although she wants to study the interrelationship of colors. She weaves functional items, too, mostly clothing, on her floor and frame looms. Currently her looms are quieter than usual, for she is studying photography and exploring the possibilities of photographic warp paintings. She paints a photographic emulsion on the warp, then covers it with a negative and exposes it to light. It will be exciting to watch the development of her work in this area, knowing as we do how Nancy immerses herself in her work with creative and imaginative results.

Katherine Frank

### Member Affairs Director

"I'm starting out with an open mind," says Marjorie Jirousek, Members Affairs Director on the Weavers Guild Board of Directors. "I see my role as one of helping to improve the relationship between various interest groups within the Guild and the Board; and to try to pull everyone together."

Marjorie's participation in the Guild goes back to the Carter and Como location where she served on the properties committee, a role she still continues in. She helps to keep looms in good repair for Guild weavers.

Her interest in primitive weaving techniques has kept Marjorie actively involved in the Bolivian study group, another Guild activity.

"My most recent involvement in weaving has been through the Minneapolis Institute of Arts and their textile collection," says Marjorie, who catalogues Native American beadwork in the Textile Department of the museum. "The beadwork has become very absorbing. All my life I have been exposed to Indian things. I grew up in Montana and went to the university there. So now I enjoy studying the beadwork in depth."

Marjorie has recently returned from a trip through the western states where she researched Native American beadwork techniques and artifacts. She studied the extensive collections in both the Denver Museum of Art and Museum of Natural History. This spring she will lead a seminar on Native American beadwork at the Minneapolis Institute of Arts.

In her role of Members Affairs Director Marjorie looks forward to an interesting and productive experience on the Guild Board. "I expect this to be a very educational experience."

Nancy Haley



### Outreach Director

An article about Outreach Director Irene Wood appears in the February 1978 *Minnesota Weaver*.

# SHOWS & EXHIBITS

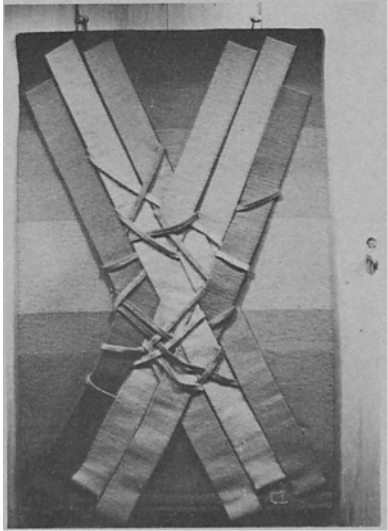
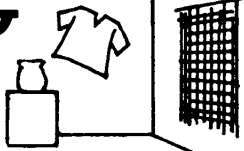

"Intersectional," award winning hanging by Cathy Ingebretsen.  
Photo by MCC staff

## MINNESOTA CRAFTS COUNCIL JURIED EXHIBITION

October 15 through November 19  
Tweed Museum of Art, University of Minnesota,  
Duluth, Minnesota

The Minnesota Craft Council's Annual Meeting was held in Duluth on October 14th. As a part of this event a juried exhibition by members of the MCC was mounted in Tweed Museum of Art on the campus of the University of Minnesota, Duluth. The jurors were Malcolm and Miriam Lein, organizers of the Fiber/Clay/Metal Biennials at the Minnesota Museum of Art in St. Paul. Catherine Ingebretsen, St. Paul, received a \$150 Award for Excellence for her hanging "Intersectional." This work is made up of intersecting weft faced orange stripes on a background piece woven in three harness Krokbragd. The warp is of linen. She has used Ciba acid dyes of red and yellow to tint her wool yarn various shades of orange. Her other entry was a hand marbled quilt which is reminiscent of a calm landscape with its pastel colors and predominantly horizontal designs.

Marbling was first used by the Persians about 1550 A.D. The technique is one of coloration where oil based paint is floated on the top of water then picked up by paper or cloth which is dipped into it. The swirling designs on the end papers of old books were produced in this manner. The quilt, made up of rectangular pieces, is bordered with a wide blue band and thin strips of green, violet, and tan. Some of Cathy's thoughts on its creation are as follows, "I chose pastels because this is my quilt for my bedroom. I wanted it to be soft, quiet, gentle and yet reflect my love of nature, of the blue sky, of the waters, of the land, of the sunlight and daylight. It is with me to begin my day in a pleasant manner and end it with the hope of a new tomorrow."

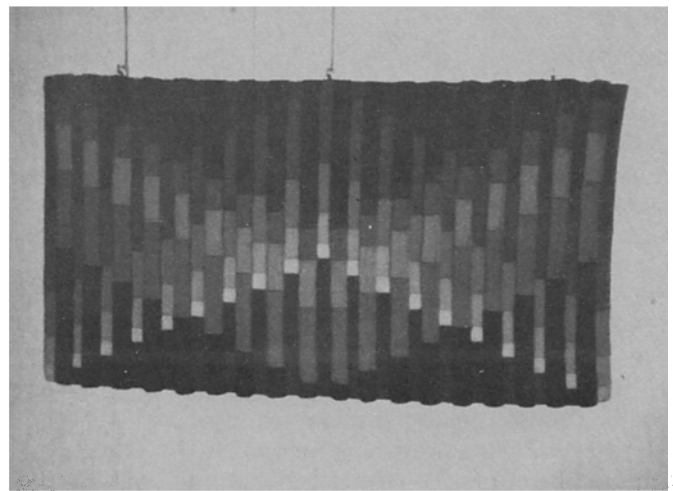

Untitled tapestry by Lydia Kulesov-Thorpe. Photo by Janet Meany

Among the other pieces of interest was Linda Nelson Bryan's "Main Lobby No. 3," a stuffed and painted relief which is a strong statement in portraiture. There were a number of styles and concepts, ranging from traditional weaving to three dimensional fiber works as well as batik, stitchery, and surface design. The rest of the exhibition was made up of ceramics and jewelry.

Janet Meany

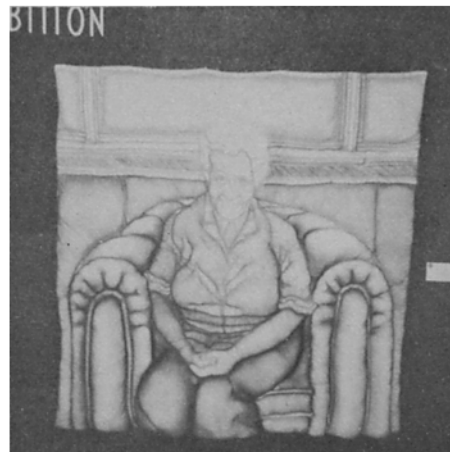

"Main Lobby No. 3," stuffed and painted relief by Linda Nelson Bryan.

## NEEDLEWORK V AWARDS

Needlework V, a stitchery show sponsored by the Needlework Guild of Minnesota for the benefit of the Minnetonka Center of Arts and Education was held October 7-15.

In the category of original Bargello pieces, the awards were taken by Weavers Guild members Mary Temple, Second; Lis Jones, Third and Ruth Reed, Honorable Mention.

## FRAME LOOM SHOW:

Wednesday Weavers Gallery Show at St. Paul YWCA until Dec. 20. Featuring weaving, stained glass, pottery. Open from 10-3 daily. Frame loom classes, you're especially invited.

## ATTENTION ALL FIBER ARTISTS:

The Community Exhibits Committee is planning a high quality art show at the Plymouth Church Gallery, located at 1900 Nicollet Avenue, Minneapolis in May 1979.

We urge everyone interested to plan on entering this show. The jury and other details will be published in the February Minnesota Weaver. This will be a great opportunity to show your work.

## OSBORNE GALLERY SHOW

Several Guild members are represented in the Fourth Annual Holiday Craft Show at the Osborne Gallery in St. Paul on Grand Avenue near Lexington. The show, which runs from November 8 through January 6, includes work by weavers Cathy Ingebretsen, Sue Obrestad, Sue Mansfield, Kathy McMahan and Barbara Sykes. Pottery, sculpture, jewelry, batik and woodcarving are also on view. Gallery hours are 10 am to 5 pm, Monday through Saturday.

## HOLIDAY ART SHOW

Saturday Go-to-Market days is sponsoring a Holiday Art Fair on Saturdays November 25 and December 9 from 9:00 am to 4:00 pm. The fair is located in the Endicott-Pioneer Arcade in the Lowertown area of downtown St. Paul.

## EGYPTIAN TAPESTRY EXHIBIT AT NORTHRUP

An exhibit of Children's Tapestries from Harrania, Egypt, will be shown at the University of Minnesota Gallery, Northrup Hall, from January 4 through February 4. The collection is owned by David B. Williams of Sonoma, California, who will give a lecture at the University in connection with the exhibit's opening.

Sales for the tapestry exhibit will be handled by the Weavers Guild of Minnesota.

If you will be showing your work in a Twin City area gallery or other exhibit, please let us know about it as far in advance as possible so we can publicize it in this column.

Members who attend fiber shows in this area or elsewhere are invited to send in reviews, impressions, etc. to *The Minnesota Weaver*.

# A Wool Gathering

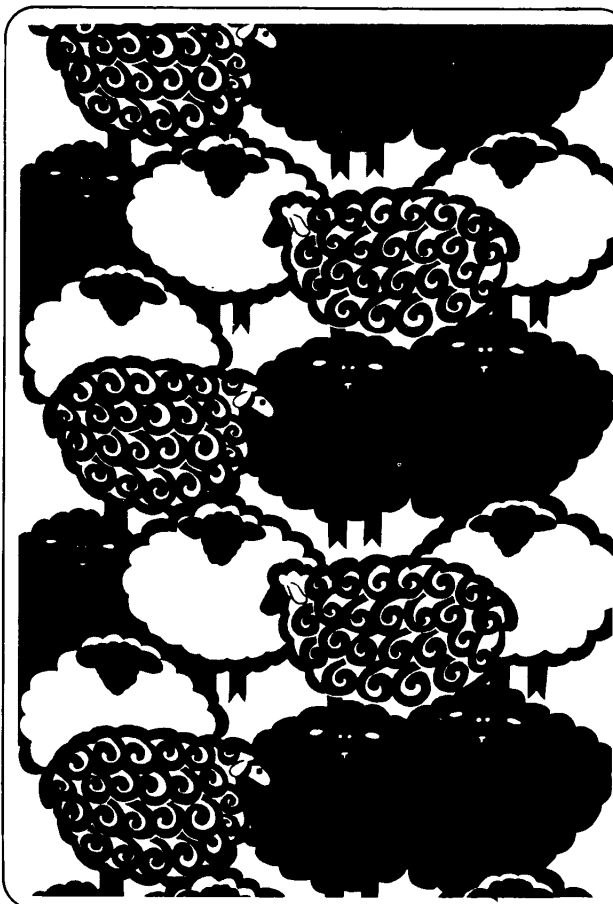

"Bathsheba" by Alleniana from our collection of graphic fabrics.

Good wools to weave dreams of.

Reynolds Lopi, Shetland, Troll, Poemes, Icelandic Homespun. Brunswick Pomfret, Germantown. Indiecita Alpaca. Tahki Donegal Tweed. Hampshire Two Ply and Designer. Unger Britania. Yorkshire. Apollo. Stanley Mirabella, Brush Spun, Multiglo, Zoom Zoom, Nature Wool.

## depth of field earth works

405 Cedar, Minneapolis, MN 55454 (612) 339-6061



# SCHOOL NEWS

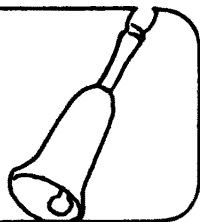

by Nancy Haley

## JANUARY INTERIM PROGRAM

Simplicity, strong design elements and a sense of history of the people are the themes repeated throughout the January Interim Program of ETHNIC WEAVES—NAVAJO, BOLIVIAN, TURKISH. Three faculty members who are specialists in these distinct weaving regions of the world will teach the role of the culture in the weaving as well as the techniques. Students may register for all three, or, if space permits, they may register for only one of the segments.

Beginning as well as more advanced weavers can learn a broad range of skills easily transferred to any simple loom. They also build a set of off-loom techniques. Many of the skills acquired could be translated to contemporary applications.

### NAVAJO WEAVING

"Navajo weaving is almost spiritual," says Jan Carter, who transfers her love of this art form to her teaching. "The evolution of the designs as they suggest the history of the people is very thrilling. The alternation, repetition and balance take place on the loom and the design begins to take off on its own."

From fiber to fabric students prepare all of the materials themselves—using dyes, spinning yarn and weaving. Students look at the history of the people and see the placement of color, the freedom of design and the rhythm of the weaving. They learn how geometric designs are used dynamically by Navajos within the limitations of the loom.

Currently there is a revival in Navajo weaving. With increased demand and interest, some rugs are valued as highly as Persian rugs. After a decline in the last century when traders stocked inferior strings and commercial yarns, native weavers began to become interested in authenticity and historical value. Once again the yarns are fine, setts are closer and dyes are natural.

"Experiencing the freedom of the designs and the rhythm in the handling of the strings makes you appreciate contemporary Navajo rugs," says Jan.

### WEAVING OF TURKEY AND THE MIDDLE EAST

"Middle Eastern weaving is a very ancient art, but the weaves are simple. Any beginning weaver would feel comfortable in this class," says Char Miller, who spent five years in Turkey. She organized a weaving cooperative there.

Pile carpets exist from as far back as the 4th Century B.C. People have collected them since the Renaissance. Nearly everyone is familiar with these pile rugs. The motifs and the oriental rug techniques have been studied extensively.

Students will try pile and major flat weaving techniques. Emphasis is on design and the history of the weaves of the Middle East. Categories and information on the types of rugs will be discussed.

"This weaving—all of the weaves taught in this interim session—can give a beginner or an advanced weaver a set of basic simple-loom and off-loom techniques," says Char. "They don't require the ownership of an expensive loom. You can create beautiful contemporary pieces with these skills."

### BOLIVIAN WEAVING

With a step-by-step simplicity, the intricate weaving of Bolivia is taught by Adele Cahlander. She eagerly shares the answers to her own question as a student, "How do the Bolivians do this?" Driven by a desire to know the answer, she traveled to Bolivia and subsequently co-authored the book, *The Art of Bolivian Highland Weaving*, a classic in its field.

Students learn a basic set of weave structures in the Bolivian tradition. With the utmost simplicity in tools—often only a bit of string and a little yarn, beautiful and complex pieces can be woven. Without the bulk of a loom, Bolivian weaving can be very portable. Elaborate weaving can be done with materials so minimal they can fit in a pocket.

### BASIC SPINNING, WEAVING AND DYEING

Share in the excitement of this introduction to basic fiber arts skills. While students learn how to spin, weave and dye fibers, they generate an enthusiasm that is infectious to everyone around the Guild at this time.

From fiber to fabric, learn the arts of spinning, weaving and dyeing in the January Interim Program.



**NATIVE ART TOURS**  
WINTER 1979  
WRITE - TERESA JOHNSON  
RFD IVANHOE, MN 56142  
OR CALL - 1-507-694-1437

**GUATEMALA - WEAVING, ARCHEOLOGY**  
**OAXACA - WEAVING, POTTERY, BASKETRY**  
**CENTRAL MEXICO - POTTERY, WEAVING**



# SWATCH PAGE

## DOUBLE WEAVES WITH 4, 6, AND 8 HARNESSES

by Paul O'Connor

### D. Tubular Weaving

I suppose that Jean Stamsta is the weaver best known for woven tubular forms but quite a few other weavers have used this type of weaving in a variety of ways. If both selvages in double weave are joined, a tube is created. Only one shuttle is required and the secret lies in the treading sequence. The threading and skeleton tieup are the same for weaving separate layers or for double width cloth. However there is one difference. To weave tubes correctly, an odd number of warp threads should be used. The extra thread can be in either the top or bottom layer and it can be threaded in a separate dent or in the same dent with two other warp threads. The weave structure in Figure 1 shows why this extra warp thread is required. (The extra thread is indicated on harness #1 and is in the top layer.) The treading sequence is 1; 134; 3; 123, and repeat. If the treading sequence 1; 123; 3; 134 is used, there will be two threads in the same shed at each selvage as shown in Figure 2.

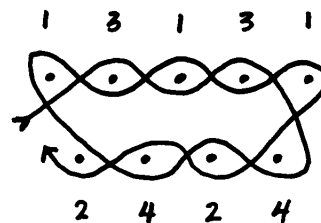
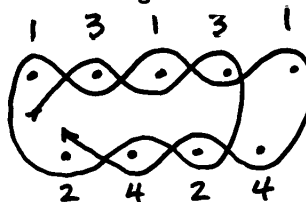

FIGURE 1. WEAVE DIAGRAM FOR TUBULAR DOUBLE WEAVE

FIGURE 2. TREADING ERROR IN TUBULAR DOUBLE WEAVE



What happens if you have an even number of warp threads? Figure 3 shows the weave diagrams for the two treading sequences given above. The first treading sequence gives a double warp thread at the right selvage and the second gives the double warp thread at the left selvage. It is possible to pull out one warp thread after you take the piece from the loom (or you could even leave it in).

FIGURE 3. WEAVING ERRORS WITH EVEN NUMBER WARPS.

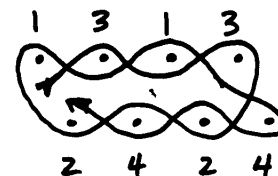
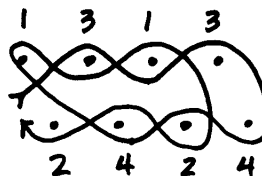

This is a good place to summarize what we have said about double weaves in these three articles. *The treading sequence is the only difference between weaving separate layers, double width cloth, and tubular weaving (plus meeting two shuttles for weaving separate layers).* Table I will let you compare the three forms of double weave. Skeleton tieup and full tieup treading sequences are given.

Table I. Double woven forms

Type	Treading sequences		
Separate layers	1, 123, 3, 134	or 1, 2 + a, 3, 4 + a	Two shuttles
Double width	1, 123, 134, 3	1, 2 + a, 4 + a, 3	One shuttle
Tubular weaving	1, 123, 3, 134	1, 2 + a, 3, 4 + a	One shuttle

There are many examples in Shuttle Spindle and Dyepot where tubular weaving has been used in one way or another. Jacquetta Nisbet has made a light sculpture (Fall 1973), Ena Marston gives instructions for a tubular dress (Spring 1975), and a number of Joan Russell's works are presented in the Fall 1974 issue. One of Jean Stamsta's hangings called "Tarzan's Rope" from the Cleveland fiberworks show is on page 34 of the Fall 1977 issue and of course Onagi's "A Red Glove" from the 8th International Tapestry Show seems to be a gigantic tubular double weave (Winter 1977).

Tubular weaving is one of the ways to weave pockets. These can be left open at one end to make pillow cover or to make a small purse or glasses case or the pockets can be stuffed on the loom for a three dimensional hanging. Here are instructions for each of these and I am sure that you can think of more ways to use tubular double weave.

**Pillow covers.** Figure 4 shows you you might weave a pillow. About an inch of tabby is woven, then the tube is woven for the length desired. Use some hemstitching technique to hold the weft threads in place before cutting the weaving from the loom. It might be wise to machine sew the top opening of the tube. Then turn the pillow cover inside out so that the tabby edge is inside, slip in the pillow, and use an embroidery stitch to close the pillow cover.

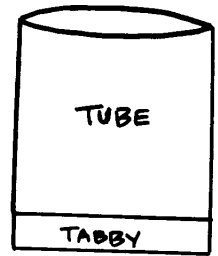

FIGURE 4. PILLOW COVER

**Small purse or glasses case.** Figure 5 diagrams how you might weave this article. You would proceed in the same manner as weaving a pillow cover but after weaving the tube to the size you want, weave only the lower layer to make a flap that would be folded over to close the purse. Of course there will be warp ends that must be finished perhaps by weaving them back in after you take the purse off the loom. Or perhaps you would prefer to make some kind of a warp fringe.

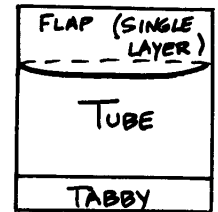
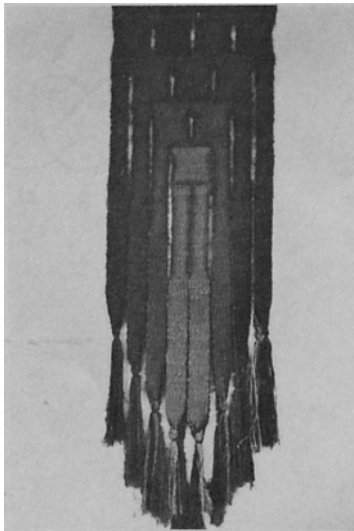

FIGURE 5. PURSE OR GLASSES CASE

**Pockets stuffed on the loom.** It is quite easy to weave tubes that can be stuffed while the material is still on the loom. Weave a section of tabby, then double weave in tubular fashion for the length you want and poke in the stuffing material (dacron, thums, . . . ). Now weave two shots of tabby to close the pocket. This gives a stronger closure for the pocket than simply interchanging the two layers. You are ready to weave another tube, stuff it, and close again with tabby. The tabby closure will be almost invisible. One of Mary Temple's wallhangings is shown in the photograph, and several double weave techniques have been used, including stuffed pockets.



Padded Double Weave Hanging by Mary Temple.

**Winter cap, dolls.** Why not weave a tube and make it into a winter cap? Or make a doll and stuff it on the loom? In the Winter 1977 issue of SS&D, Betsy Finch gives detailed instructions for weaving "Floppy Dolls" using four harness tubular double weave. Figure 6 is a simplified diagram of her ideas but I would urge you to read her article for some interesting ways to handle the warp ends.

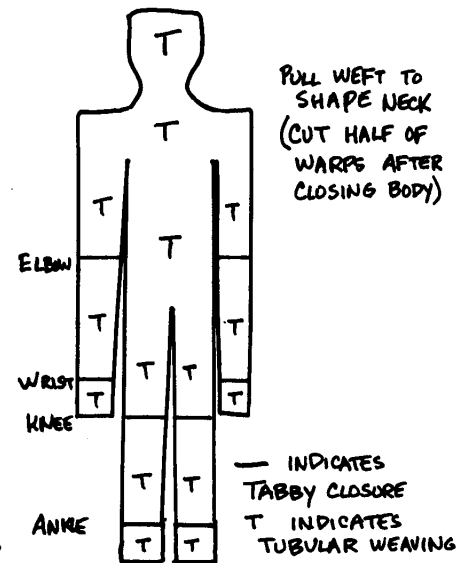
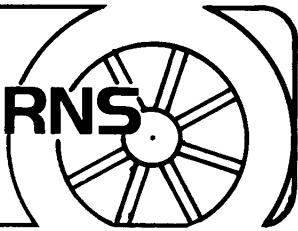

FIGURE 6. "FLOPPY DOLL".  
TUBULAR STUFFED WEAVING

# AS THE WHEEL TURNS



by Pat Boutin Wald

Our neighbor at the new guild, Noll Hardware, carries two kinds of cotton Mason's Line that make good drive bands for spinning wheels. Noll's address is: 789 Raymond Ave.

An article entitled "Protecting Your Valuable Handspun Yarn From Insects" can be found in the guild library collection of *Mother of All News*. It is of special interest to all of us who store quantities of wool products in our homes.

It was my pleasure recently to attend the Mid-State Spinner and Weaver's Spin-In at Wausau, Wisconsin. Events of the day included: sheep shearing, a handspun fashion show, raffle, and a discussion and display of coverlets by Ken Colwell. There was much to see and do. Antique spinning supplies available at commercial booths kept observers and shoppers busy. The enthusiasm of the spinners inspired many visitors to pick up a spindle and attempt spinning for the first time.



Sheepshearer Marvin Schilling PHOTO BY THE WAUSAU DAILY HERALD

Dear Karen,

Re: Advertisers

I will no longer have weaving time, but I will always have time to appreciate weaving. Currently I'm having 30 pounds of wool spun and woven for a hall runner. In order to indulge in these necessities I'll need you support. How many of you moved this year? How many did not have a particular realtor to turn to? How many noticed my ad? Please note: I am now with BARTON REALTY 920-6055. My home phone is still 544-0235. I can help in either city or suburbs. If I can answer any questions regarding real estate or help you with your move, please call.

(P.S. This is a paid ad)

LAEL EGINTON

My compliments and thanks to the organizers: Gen Stromme, Molly Pearce, Nancy Hessel, Sue John and Jeanne Walters. I hope that they will keep us notified of their future activities!

## QUESTION:

I've heard of bushings on spinning wheels. What are they, where are they, what do they do, and what are they made of?

The Glaski's, spinning wheel builder from Unity, Wisconsin, have provided us with this answer:

A bushing is a little cylinder of material with a hole in it. A metal shaft turns in this hole. This metal shaft can be the drive wheel axle, the flyer shaft, or even the pins in the ends of the treadle bar.

Leather and rawhide have been used as bushing material for thousands of years and leather is still frequently used today. Bone and special hard woods were once common bushing materials on spinning wheels, but they have been largely replaced with plastics such as nylon and teflon.

Important reasons for using bushings in spinning wheels include reduced wear, reduced friction, and prevention of binding when there are changes in moisture or temperature. Leather has the additional ability of helping reduce vibration.

## CORRECTION:

Last month we made an error in the question section. The first paragraph in the Glaski's answer should have read (corrected words underlined):

"The driven bobbin spinning wheel, with its flyer brake, has several general names. If the flyer assembly is large and the drive wheel small then the spinning wheel may be called a bulk wheel or Indian head spinner. If the flyer assembly is small and the drive wheel large then it may be called a swiss wheel."

We hope that this did not cause too much confusion.

If you have questions concerning spinning wheels or techniques, send them to me c/o *The Minnesota Weaver*.

Private Lessons in  
Four Harness Weaving



LYNNE NORRIS  
612-933-8104

Take a four harness table loom home to use between lessons; use a floor loom in my Minnetonka studio.

\$50+ materials, four weeks. 933-8104



Linda Maschwitz checks in the entries while Mary Temple advises.

# FIBER FAIR

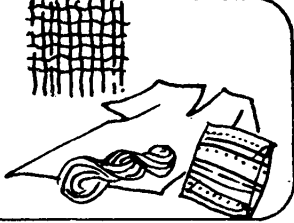

The sixty-seven entrants filled the Guild to overflowing with their goods. A total of \$6700 in sales was recorded. A detailed report will appear in the next *Minnesota Weaver*. Here are some highlights in pictures.



Anna Smits and Lisbeth Uptis arrange a hanging.



The display props are assembled.



The displays are completed.



Enjoyment for all ages.



The line-up for the Cashier's table.



Photos by Nancy Haley and Karen Searle

Susie Chitwood demonstrates one of her puppets.



Ethnic weaving demonstrators  
Charlotte Miller and Sue Balzerman



# SNOWY DAYS

Time for weaving with  
Glimåkra looms and tools,  
Borgs i Lund yarns.

\*\*\*

\* *M. Susan Brock Ltd.*

*1838 St. Clair Ave.*

*St. Paul, Minnesota 55105*

*tel. 612/699-1909*

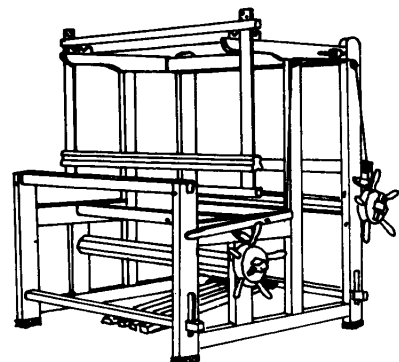

# U OF M EVENTS

## KEN WEAVER WORKSHOP

**Monday Sept. 18 through Friday Sept. 22, 1978**  
**University of Minnesota, St. Paul Campus, Mc Neal Hall**

In September of this year a five day workshop, *Problems in Design 5588*, was held at the University of Minnesota, Twin Cities, College of Home Economics, Design Department. The intent of the workshop was to design, weave, and install a hanging for the wall of Room 22, conference room of McNeal Hall. This was to be done under the guidance of Ken Weaver, teacher and professional weaver from Atlanta, Georgia. Charlene Burningham of the Design Department was the coordinator for the workshop handling all of the initial groundwork and prior preparations as well as the supplies and equipment. Seventeen students were enrolled, the majority design students, several Weavers Guild of Minnesota members, one from Canada, and two from Blue Cloud Abbey in South Dakota. The prerequisite was a familiarity with the "rep" weave technique.

A planning session was held with Dr. Gertrude Esteros, Head of the Design Department, and Dr. Keith McFarland, Dean of the College of Home Economics, where slides were shown of the directions in which the work might go. Eight design areas were explored and the combination "barnacles and tubes" was chosen because of its diversity of form possibilities and for its ease of manipulation with a group of people this size. Other plans would not have allowed such latitude for the organization of single elements into an integrated whole.

ool yarns in a mix of warm reds, rusts, purples and pinks were chosen to complement the brick wall surface on which the project was to be mounted. The remainder of the room was predominantly white with structural elements in grey cement. The brick surface, having slight indentations, was formerly the outside wall of McNeal Hall but now is incorporated into a new wing of modern design. These, therefore, were the elements to consider along with the height and width (18' x 23') of the space. The students were encouraged to express their individual thoughts as to the possible composition of the intended work and it was generally agreed that the aggressive surface of the wall with its flat projected areas required a piece which would dominate with its sculptural shape, size and color.

Ken's procedure with a client was outlined including such considerations as lighting (he insists on the installation of lights *before* the piece is hung), installation (so the piece cannot be stolen), price (cost of yarns, labor, etc.) and suitability of the finished hanging to its space and environment.

The next step was the winding of the warps and the dressing of the looms. Specific directions were given as to the color arrangement, size and length of the warps. All parts were woven in the "rep" technique using 36 epi with from 40 to 80 threads to each pick in the weft depending on the requirements of the piece. The alternate pick was red 10/2 linen. Warping procedures were demonstrated and reviewed throughout the workshop and weaving techniques meticulously explained. There was an atmosphere of serious intent as the warping was completed and the weaving commenced. Deadlines were set and at a designated time the finished pieces were removed from the looms and the cutting and sewing begun. The tubular forms were stuffed and the barnacles joined and one end pulled in to give them their characteristic rounded shapes.



Working out the design.

When this phase was completed, all of the forms were assembled in the conference room and the work of composition begun. Guided by Ken, a large overall structural plan was projected. Under his direction and with input from the group, the single elements were arranged into their component parts. A brown paper model was cut and placed as a guide on the wall surface and each single grouping was then mounted through the loops in the wire which was attached to the back of the hanging. Screws were placed through the loops and driven into holders in the wall. This was completed the afternoon of the last day and the reception was held at 4:00 p.m. that afternoon.



The completed hanging.

Some interesting statistics were recorded with regard to the weaving of the hanging. 180 pounds of wool and 10 pounds of linen were used in 20 warps, a total of 360 feet long. 850 hours were needed to complete the hanging, or for one person it would have taken 5½ months of steady weaving. The cost of the materials, paid by the University, was approximately \$400 for a hanging which in the commercial market could have cost from \$8,000 to \$10,000.

The workshop provided a unique opportunity to work with a professional weaver on a particular project from start to finish. This is a tribute to Ken's exceptional teaching abilities that the students at all times felt themselves an integral part of the planning and execution of the hanging.

Janet Meany

## THE MINNESOTA WEAVER

published 9 times a year by the Weavers Guild of Minnesota Inc.

Editor..... Karen Searle  
 Copy Editor..... Mary Skoy  
 Shows & Exhibits Editor..... Suzy Sewell  
 Swatch Page Editor..... Paul O'Connor  
 Art Editor..... Dianne Swanson  
 Photographers..... Nancy Haley, Karen Searle  
 Artists..... Barbara Fritzberg, Kathy McMahon  
 Reporters and Columnists.....  
 Rose Allen, Debby Alper, Andrea Blue, Pat Boutin Wald,  
 Kathie Frank, Barbara Fritzberg, Cathy Ingebretsen, Lis Jones,  
 Connie Magoffin, Sue Obrestad, Joy Rosner, Bev Skoglund,  
 Mary Temple, Nancy Haley among many others  
 Office..... Phyllis Pladsen, Pam Prosser, Roberta Wurden  
 Index..... Barbara Fritzberg  
 Typesetting..... Summit-University Free Press

### Our Advertisers This Month:

Beka Looms  
 Earthworks  
 Ewe & Me  
 House of Macrame  
 M. Susan Brock, Ltd.  
 Teresa Johnson  
 The Yarnery  
 Wool-N-Shop  
 Lael Eginton

They support us —  
 please support them.

### Guild Annual Membership

Individual..... \$15.00  
 Family..... \$20.00  
 Sustaining..... \$25.00 or more

Subscriptions to the *Minnesota Weaver* (for persons living over 100 miles from the Guild)  
 ... \$5.00 per year  
 outside the U.S. \$6.50 per year

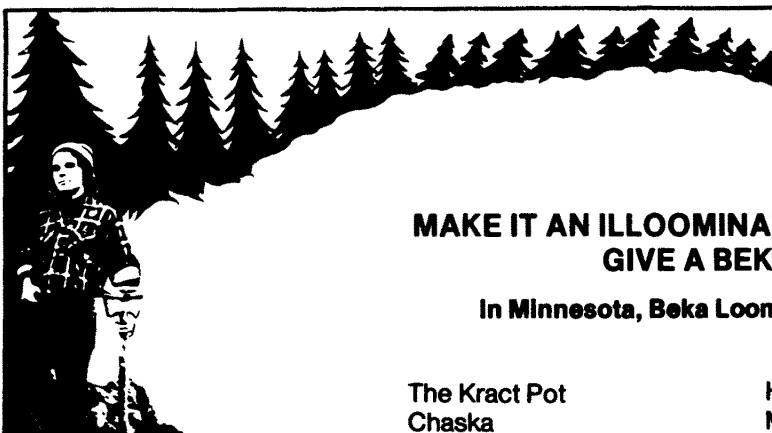

# Beka Looms

**MAKE IT AN ILLOUMINATING CHRISTMAS . . .  
 GIVE A BEKA LOOM**

**In Minnesota, Beka Looms may be found at:**

The Yarnery St. Paul	The Kract Pot Chaska	House of Macrame Minneapolis
The Yarn Barn Northfield	The Yarnery Edina	Yarn Shed Robbinsdale
St. Croix Kits Stillwater	Char-Es Family Craft Center Burnsville	Yarn Barn Coon Rapids
The Yarnery Roseville	Needles Galore Burnsville	Ye Olde Needlecraft Shoppe Grand Rapids
Creative Learning Center Roseville	Country Ways Minnetonka	Owl's Perch Virginia
Pot Shop Anoka	Wooly Bully Wayzata	Endion Station Craft Shop Duluth
Fibers Plus Champlin	Depth of Field-Earthworks Minneapolis	Mary Lue's Yarns St. Peter
	North Central Wool Market Minneapolis	Handworks Morris
		Spinning Wheel Redwood Falls
		The Yarn Loft St. Cloud
		The Spider Web Brainerd
		Nordic Galleri Fergus Falls

for free catalogue write: Beka Inc. 1648 Grand Ave. St. Paul, Mn. 55105 (612) 222-7005



New  
Books

Finishes in the  
Ethnic Tradition

&

Clothing a Handwoven Approach

*House of  
Macrame*

5416 Penn Ave. So.  
927-8307

check with us about our student discount

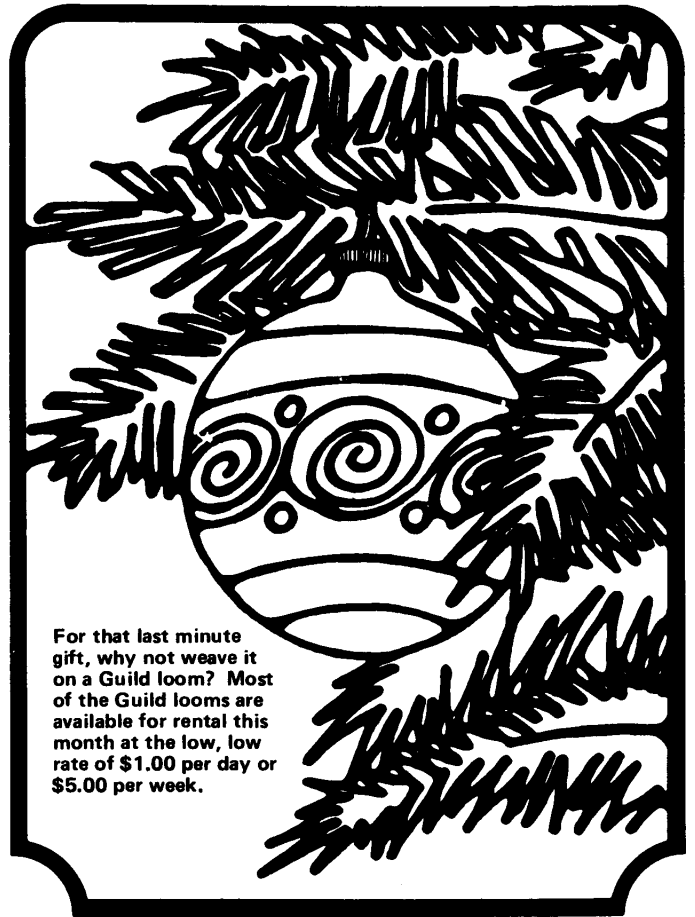

For that last minute  
gift, why not weave it  
on a Guild loom? Most  
of the Guild looms are  
available for rental this  
month at the low, low  
rate of \$1.00 per day or  
\$5.00 per week.



the **Yarnery**

## Holiday projects

Scarves, wall hangings, table runners,  
for whatever you're making this holiday season,  
we have a variety of gorgeous yarns you'll  
want to consider.

## Holiday presents

Beka's new 14 inch frame loom is wonderful  
as a second loom — very portable — or as  
a first loom for a young weaver. \$28.00

1648 Grand Avenue, St. Paul 690-0211

Rosedale Shopping Center, Roseville 631-2800

Leisure Lane Shopping Center, Edina 922-7179

# BULLETIN BOARD

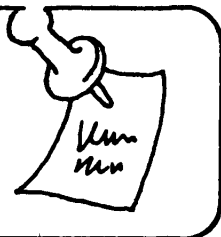

Members notices published here at no charge. Non-members may place classified ads at 15¢ per word.

## WANTED:

Weavers, spinners, and dyers interested in selling what you've made and didn't sell at the Fiber Fair, try the Endless Thread, an outlet in your interest. Call Ann Scher at 224-8535 for more information.

Members in a "South of the River" study group. Lynn Anderson would like to organize such a group to meet evenings or weekends. If interested, call Lynn at 435-5383 after 6:00 or Sue Lawson at 453-3907.

Volunteer to warp a 4 homess floor loom and/or a 4 harness table loom at the Oak Terrace Nursing Home in Minnetonka. The contact person to call if you can help these people is Norma Anderson at 938-7621.

Participants on a group order for magazine files. We would like to order some for the Guild library but in order to get the best price break we need to order more than 100. They are made of sturdy corrugated cardboard with a walnut-woodgrain finish. The files stand up straight so there is no need for bookends. Sloping sides make reference and retrieval easy. Size: approximately 4"x9"x11¼". Price for each is \$1.09 plus shipping. If you are interested in purchasing some for your personal library, please give your order to Suzette by January 1.

## SPECIAL HOLIDAY VACATION PUPPET WORKSHOP

Date: Thursday, December 28, 1978  
9:00-12:00 noon

Presented by: Louise Cameron

Cost: \$8.00 — includes materials for making 3 puppets

Fascinated by hand puppets? Learn to make your own from a basic pattern—any animal or character can be created. You need to know how to thread a needle and do the basic sewing stitch. Come prepared with an idea of a puppet you would like to make: from a story book, a nursery rhyme character, or Sesame Street people. Go through Mom's or Grandma's sewing drawer and bring buttons, rick rack, thrums, pieces of ribbon, and pretty bits of cloth.

This workshop is designed for children—but not limited to children. There is space for 8 to 10 kids and the rest for adults. It might be a fun workshop to take with your kids or your grandchildren!

Registration Form:

Number of participants: \_\_\_\_\_

Total amount enclosed: \$ \_\_\_\_\_

Names of participants: \_\_\_\_\_

Name \_\_\_\_\_ Phone \_\_\_\_\_

Address \_\_\_\_\_

City \_\_\_\_\_ Zip \_\_\_\_\_

Please return to the Guild office by Thursday, December 21, 1978.

## FOR SALE:

Beka 30 inch frame loom. Original warp still on loom. \$26.00.  
Beka Weaving seat has never been used. \$20.00.  
Call Lynne, home 435-5383; work 821-2505.

45 inch 4 harness counter-balance loom. It's well over 100 years old. All handmade with peg construction. Contact: Tucki L. Bellig, Rt. 3 Box 128, St. Peter MN 56082 507-931-1176.

## ATTENTION DEMONSTRATORS

Please fill out the form below and send it in to the Guild office if you are willing to give demonstrations of your fiber craft.

Name \_\_\_\_\_

Address \_\_\_\_\_

Phone \_\_\_\_\_

Demonstration subjects \_\_\_\_\_

Fee charged:  yes  no

Area preference:  metro area  close to home

other (please specify) \_\_\_\_\_

## Wanted for the Guild:

A vacuum cleaner, especially for shag carpeting.



**THE MINNESOTA  
WEAVER**

Published monthly except July, August, and December  
Weavers Guild of Minnesota

The Weavers Guild of Minnesota  
2402 University Avenue  
St. Paul, Minnesota 55114  
644-3594

NON PROFIT ORG.  
U.S. POSTAGE  
PAID  
PERMIT NO. 2963  
MPLS., MINN.

**Dates to Remember**

- |                         |                   |   |
|-------------------------|-------------------|---|
| <b>Thursday Dec. 7</b>  | <b>1:00-3:00</b>  | <b>Guild Meeting at<br/>Science Museum</b>                |
| <b>Thursday Jan. 4</b>  | <b>9:30-3:00</b>  | <b>Coverlets day—by<br/>reservation<br/>or invitation</b> |
| <b>Thursday Jan. 18</b> | <b>9:30-12:00</b> | <b>By Member/For Member<br/>Yarn workshop</b>             |
| <b>Thursday Feb. 1</b>  | <b>1:30-3:00</b>  | <b>Program: Textile<br/>Preservation</b>                  |

**DEADLINE FOR NEXT ISSUE**  
January 5 - copy for typesetting  
January 10 - camera ready copy

WEAVERS GUILD  
MINNESOTA

