

trified by the friction of spinning and will repel one another until the clearers will bristle with an accumulation of waste that will attract still more material from the passing rovings. The rapid revolution of thousands of spindles will further set in motion appreciable currents of heated air, which will rise toward the ceiling and still more effect the work of the machines until good yarn seems impossible of production. The remedy for this condition is either to keep the room at as low a temperature as is possible to work in comfortably, or to supply the air with a suitable amount of moisture so that it will not absorb that of the cotton yarn and roving. The lower the temperature, the less moisture will the air hold or absorb, the higher the temperature, the more moisture it will require for saturation, and the warm air will take up the moisture of the cotton quicker and in a greater degree. By observation and the use of a hygrometer, as will be referred to in the chapter on humidity, etc., it is possible to ascertain the best working conditions of the atmosphere of a spinning room, and efforts should be made, by ventilation, etc., to maintain the ideal temperature and humidity.

(To be continued.)

Looping with a Large Dial Julius Koehler Looper.

Looping or seaming form one of the most important processes in the manufacture of hosiery and knitted fabrics. Upon this operation depends the finished appearance of the fabric, and it requires quick eyes and nimble fingers to loop the stitches properly.

On the old style loopers it was necessary for the operator to cut and brush the ravelings off the course of the points, but in this machine they are cut and brushed off automatically, thus saving time and labor, and enabling the operator to work all the faster and at the same time its simplicity of design and operation lend to the production of superior work.

The movements of the machine are encased in a metal box to keep them secure from dust and foreign matter, the large 16 inch dial being supported by an arched arm connected to the box or foundation of the machine. This same arm carries the guide for the feeds.

The dial is made in various gauges, ordinarily 8-9-10-11-12-13-14-16-18-20-22-23-24 and 26 needles to the inch, according to the class of work for which it is desired.

The operation of the machine is very simple and every part is protected in such a way that no injury may happen to the operator or fabrics in process.

To thread the machine and for minor movements a crank and handle is attached to the driving shaft to bring the working parts in the required position.

In starting the looper, the clutch handle, at the bottom of the machine is used, bringing the movable pulley in contact with the stationary one, a lug being provided on the movable pulley to come in contact with grooves in the other on the main shaft.

The movement of the dial is secured by a ratchet, which is driven by means of an eccentric disc on the main shaft, operating in conjunction with a movable

arm, which in turn moves the ratchet one tooth to every revolution of the shaft, thus producing one loop. In order that the movement of the ratchet will be regular, and that it will not slip backwards, it is provided with a catch which operates in the teeth and secures the action.

The Straight Needle is carried in an oscillating motion by means of a horizontal movable arm which is connected to an eccentric cam on the main shaft and carries one feed.

The Looper Hook which forms the loop, is operated in an irregular motion by an eccentric cam which has a groove on its surface and the motion is obtained by a lug on the bottom of a movable arm operating in this groove. This arm is connected to a movable bearing which also has attached to it the arm carrying the loop forming needle. The cam in one revolution causes the hook to pass over the straight oscillating needle, over the loop guide point and back to the straight needle again, thus over seaming and looping the fabric.

With the outward movement of the straight needle, it sometimes pushes the course away from the back of the dial and to overcome this, a tension wheel is provided, running under the points and pressing the fabric against the outside surface of the dial. The tension is produced by means of a spiral spring attached to the side of the machine. A guard plate is attached to the wheel to keep the fabric from becoming meshed with it.

Upon the far side of the dial is the cutting knife and evener. This is used in trimming off the superfluous edges and ravelings, and operates in an oscillating motion, back and forth, cutting the fabric even with the points. The evener is attached to the same arm and works a little forward of the knife and pushes the fabric back, close against the outer surface of the dial. The movement is secured by means of an eccentric and movable arm attached to a bearing of the dial. Both the cutting knife and the evener, can be thrown out of operation by raising the lever on the top of the bearing, thus raising them clear off the course of the points. In order that the fabric may not become meshed with the knife and evener, a guard is provided which also acts as a guide for the fabric.

After the ravelings have been cut off, the lint and other matter is carried along on the dial to the brush. Formerly it was necessary for the operator to do the cleaning of the course by hand, but on this improved machine it is accomplished automatically. The brush comes in contact with the needle points, and as the dial continues on its way, the brush makes one half turn forward and backward with every revolution of the main shaft. The brush is operated by means of a set of spur gears, which are connected to the crank shaft, which operate the driving arm. In order that the lint and ravelings do not get back onto the dial, the brush is provided with a detachable hood, which holds the refuse.

As was mentioned before, the machine is the idea of simplicity, there are very few springs and the parts of the machine are easily accessible for cleaning.

From this, one may easily conceive the mechanical

idea of this improved looper and an example of how the work is accomplished, using any hose or half-hose for example.

We will take the seamless half hose, made on an automatic machine with the rib-top already attached.

The half hose is delivered from the machine with the toe left open. This must be closed on a looper and the best work can be obtained by the Large Dial Julius Koehler Looper.

To thread the machine, bring two ends of the thread on the rear stand over and through the spring guide on the arched arm. Then one thread, through the upright guide, down to the straight needle and one to the looper hook, in the same manner as you would thread a sewing machine.

Take the toe of the hose, get the two points of the

The dial now carries the fabric to the last and most important part.

Here the straight needle emerges, carrying the thread and at the same time the hooked needle with another thread has passed under the point of the straight needle and over the looper guide point and back again to the straight needle, and as the straight needle withdraws from the stitches on the looper point, draws the loop tight, thus seaming the two parts of the fabric into one. It is on the same principle as a slip knot is made.

The dial then continues on its way and as the stitches are looped, one by one, gradually comes to where it started and is removed from the points a finished hose.

In putting on and taking off the fabrics, it must

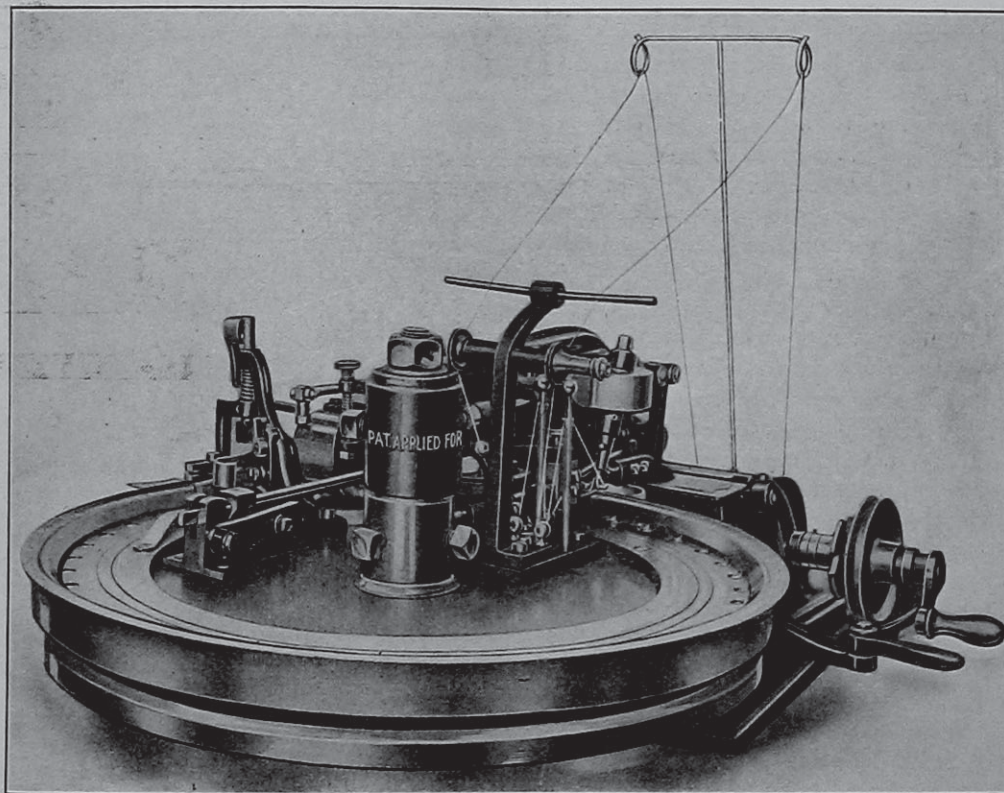

The Large Dial Julius Koehler Looper.

toe about even, then start from the far corner and get every stitch on a separate looper point, following the course carefully. When you have gone as far as possible, begin at the other end again and loop the other side in the same manner.

The machine is now set in motion by throwing on the clutch, and the dial progresses towards the cutting knife and evener.

Above the looper points, the ravellings and free edge of the toe will extend, and as it passes before the knife, it is cut off even with the looper points, thus insuring a free clean edge. At the same time, the evener is pushing the fabric close against the face of the dial.

The dial is now moving towards the brush, and as the fabric emerges from under the brush, it will be noticed that the course is entirely clean and clear of all lint, and foreign matter.

be remembered that they cannot be taken off with a jerk or put on roughly, as this tends to bend and break the points which in turn produces poor work and needless repairs to the machine. Further information regarding the machine may be obtained from its American representative, Mr. Max Nydegger, 260 W. Broadway, New York city.

THE BLEACHING, DYEING AND FINISHING OF KNIT GOODS.

(Continued from page 28.)

It will thus be seen that roll goods reach the cutting department with its right side out—no matter whether they come direct from the machine or from the drying room. It now will be interesting to follow this roll of cloth by an example through the cutting and trimming process. The operator draws from the

roll of goods a suitable length for the cutting table, cuts it off, and repeats the operation, placing in this manner a certain number of lengths of fabrics evenly distributed on top of each other on the cutting table. Now he marks the top of the pile of layers of cloth with the pattern required and saws, *i. e.*, cuts out the sections of the garment correspondingly with the pattern, cutting the smaller sections afterwards with hand shears, as well as such parts as the shoulders where the sleeves are to be fitted in. The different pieces (bodies, sleeves, cuffs, half borders) making up a certain number of complete garments, are then tied up in dozen lots and handed to the loopers for them to join the different parts (cuffs to bodies, rib tails to bottom of shirt, also the shoulders) in a manner not noticeable by the untrained eye. Looping does this work more smoothly than sewing. Next the sleeves are joined to the bodies. The process of looping the different fabric portions into one garment has been explained in a separate article on this subject on pages 282, 283, 284 and 285, and to which the reader is referred to.

The goods are then carefully examined and any imperfection met with corrected. Provided overseaming the cuffs is practised, the garments then have the cuffs and half borders joined on the edges by means of the overseaming machine.

In connection with underwear, the garments, after drying, are then removed from their forms, to be finished, *i. e.*, to have bands, buttons, etc., sewed on, to be in turn pressed and boxed. Some goods are, previously to taking them off their forms, in this condition, subjected to the action of a brushing machine, so as to present an improved appearance. The cylinder of this brushing machine, and with which the fabric comes into contact with, is covered with stout stiff bristles. This procedure, by loosening the matted fibres, gives the garment a light nap, *i. e.*, a soft wooly appearance. Although in most cases only the back of the garment is only brushed, with some fabrics both sides are thus treated (one after the other) in turn giving to the fabric a more softer, wooly appearance. The chief object aimed at by the process is to give a cotton or union fabric more the look of an all wool garment.

We will now consider the process of trimming underwear, as before roughly outlined, somewhat in detail. When the goods are received in the finishing department, they are then sorted as to size, which at the same time is stamped on each article, after which, each size kept separate, they reach the person known as marker, who marks the neck with what is called a neck marker. The neck flaps are then cut and in turn stitched down, after which the fronts of the garments are marked, cut down for button stays and button hole facings. The latter are then sewed on and the raw edges of the flaps covered. Button stays and binding are then put on, after which the buttonholes are cut and trimmed. Now the buttons, after first marking their proper position on the fabric, are sewed on and threads trimmed off. The garments are now inspected by the examiner who trims off all loose threads and at the same time marks any imperfect

garments. The goods are then folded, placed between press boards and hot pressed. When taken out of the press, any imperfect garments are laid temporarily aside, whereas the perfect ones are folded, boxed and labeled.

(To be continued.)

CUTTING NECKWEAR FROM TUBULAR KNIT FABRICS.

Prominent twill effects, it is claimed, will become the fashion in connection with woven neckwear. To imitate such oblique line effects in machine knitted fabrics, is the object of the procedure herewith illustrated and described.

Of the accompanying illustrations, Fig. 1, is a

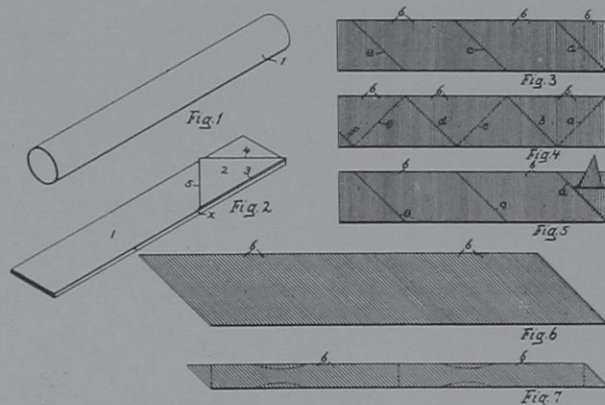

perspective view of a tubular knitted fabric; Fig. 2, is a perspective view of the tube flattened and showing a templet in position; Figs. 3 and 4, show the fabric marked for cutting; Fig. 5, shows the fabric after having been cut and ready for unlapping; Fig. 6, shows the fabric unrolled; and Fig. 7, shows a strip cut from the fabric of sufficient width for the production of neckties.

A DESCRIPTION OF THE PROCEDURE is best given by quoting numerals and letters of references and of which, 1 represents a portion of a tubular knitted fabric, shown flattened in Fig. 2. A templet 2, in the form of a 45° triangle, whose altitude is equal to the width of the flattened fabric, is then placed upon the fabric, so that one angle of 45° in the present instance touches a corner of the fabric and the base 3 of the angle is flush with the running edge of the fabric. A line (see *a* Fig. 3) is then marked along one side 4 of the triangle and a mark made at *x* on the side 5 of the triangle, which is then moved over the fabric until the angle, that was at the corner of the fabric, comes over the mark *x*, and when then another line (see *c* Fig. 3) is marked on the fabric through the point *x*, and which is parallel to the first line. The operation is repeated throughout the length of the fabric; the lines being made obliquely to the knitted courses 6 of the fabric. The fabric is then turned over, presenting its other face to the operator and the lines *b, d, f*, (see Fig. 4) are drawn so as to connect with the lines *a, c, e*, (shown by dotted lines in Fig. 4) at the edge of the fabric.

The operator then cuts on the lines *a, c, e, b, d* and *f*

but only through a single thickness of the fabric. The fabric is then unrolled and produces the strip of single thickness, as shown in Fig. 6, having its *courses* of the loops 6 oblique to the running edge.

A strip of suitable width is then cut, such as is shown in Fig. 7, which is shown in this case of sufficient length to produce two neckties; the only waste being the triangular sections at each end, as shown by dotted lines in Fig. 7. The strip is then cut in proper lengths, shaped and finished in the usual manner.

TESTING OF CHEMICALS AND SUPPLIES IN TEXTILE MILLS AND DYE WORKS.

(Continued from page *x*, June issue.)

(2) Volumetric Analysis.

Volumetric Analysis is that, in which we use a solution of accurately known strength, to test the unknown solution, and from the amount of solution used we can calculate the amount of the substance tested for in the solution. The following are some of the instruments required:

(1) *Burettes*, are tubes of uniform bore throughout the whole length; they are divided into cubic centimeters and are closed at the bottom, as shown in Fig. 1, by means of a glass stop-cock or with a piece of rubber tubing containing a glass bead *h*. The latter form is used as follows: The tubing is seized between the thumb and forefinger at the place where the glass bead is, and by means of a gentle pressure a canal is formed at one side of the bead through which the liquid will run out. Instead of the glass bead an ordinary pinch-cock is frequently used.

(2) *Pipettes*. A pipette has only one mark upon it, and serves for measuring off a definite amount of liquid. They are constructed in different forms; usually they consist of a glass tube with a cylindrical widening at the middle. The lower end is drawn out, leaving an opening about $\frac{1}{2}$ -1mm. wide. Pipettes of this nature are constructed which will hold respectively 1, 2, 5, 10, 20, 25, 50, 100, and 200 c. c.

(3) *Measuring-flasks*, are flat-bottomed flasks with narrow necks provided with a mark, so that when they are filled to this point they will contain respectively 50, 100, 200, 250, 300, 500, 1000, and 2000 c. c. They serve for the preparation of standard solutions and for the dilution of liquids to a definite volume.

(4) *Measuring-cylinders*, are graduated into cubic centimeters and are used only for rough measurements.

A given quantity of any acid requires for neutralization a quantity of any caustic which bears the same proportion to it as the equivalent number of the alkali bears to that of the acid. In the case of hydrochloric acid 36.46 grams will neutralize 53.05 grams of sodium carbonate. Volumetric analysis is divided into three sub-groups: (a) Acidimetry and Alkalimetry; (b) Oxidation and Reduction Processes; (c) Precipitation Processes.

Acidimetry and Alkalimetry is used to a large extent in technical analysis.

TO MAKE A NORMAL SODIUM CARBONATE SOLUTION.

Chemically pure sodium carbonate is used for this purpose; there must be no doubt as to its purity, it must be guaranteed. This sodium carbonate is carefully dried in a porcelain dish in an air bath kept at 212° F. to drive out the water. Fifty three and five hundredths (53.05) grams of this substance are then weighed and dissolved in one litre of water. This should dissolve to a perfectly clear solution. With the aid of this sodium carbonate solution we can prepare a normal acid solution.

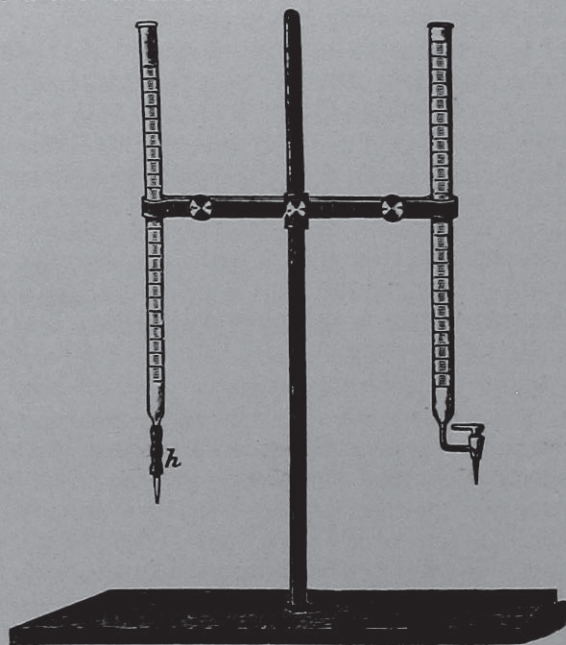

FIG. 1.

TO MAKE A NORMAL HYDROCHLORIC ACID SOLUTION.

Take chemically pure concentrated hydrochloric acid and add enough pure distilled water to it until the specific gravity of the solution is 1.020. This solution is now compared with the normal carbonate solution in the following manner. Ten c.c. of the Normal carbonate solution are carefully measured from the burette into a small beaker and one or two drops of phenolphthalein are added; the solution becomes pink in color. From another burette add the hydrochloric acid, drop by drop, meanwhile constantly stirring until the pink color disappears.

Then heat the solution and the red color will appear again. Add more hydrochloric acid solution and the color will disappear, again heat and if the pink color appears, more hydrochloric acid must be added until the color will not reappear upon boiling. (Towards the end of the reaction great care must be taken that we add the acid, one drop at a time). We now measure the amount of acid that was required to neutralize the soda; if more than 10 c.c. were used to neutralize 10 c.c. of the soda solution, the acid is too weak; if less is used the acid is too strong. Suppose the acid is too weak, then one drop of the strong acid must be added to the acid solution, the solution thoroughly mixed and the acid solution tested again. If the acid solution is too strong a little water must be added, the amount of water can be calculated. Suppose it took 9 c.c. of acid to neutralize 10 c.c. of

soda solution, then one c.c. of water must be added to each 9 c.c. of acid solution, because one c.c. of water with 9 c.c. of the acid solution makes 10 c.c., which exactly, neutralizes the 10 c.c. of normal sodium carbonate solution. So that if we have 900 c.c. of acid solution we must add 100 c.c. of water to it. After water is added to the acid solution, the solution is thoroughly mixed and is again tested.

When 10 c.c. of the acid solution exactly neutralizes 10 c.c. of the soda solution, the acid solution is a normal hydrochloric acid solution and is put away. But we must keep adding water or acid until 10 c.c. of the solution exactly neutralizes 10 c.c. of the soda solution. The two solutions are put in clean dry glass stoppered bottles, the bottles are properly labeled and put away. These two solutions are used frequently and must be made up carefully. The acid solution is used to test bases or alkalies, for example soda and bicarbonate of soda; the soda solution is used to test the strength of acids, for example oil of vitriol, muriatic acid, etc.

The preparation of other normal solutions will be given as occasion arises.

THE INDICATORS.

In volumetric analysis we have frequent use of indicators. The ones most generally used are litmus, phenol phthalein, and methyl orange. By use of an indicator we can tell whether a solution is acid or alkaline.

Litmus is most conveniently used in the form of litmus paper which can be bought from any dealer in chemicals. Litmus paper is blue in alkaline solutions and red in acid solutions, it cannot be used for delicate work.

Phenol phthalein is generally used in solution. The solution is made by dissolving one gram of pure phenol phthalein (which is a white powder) in 100 c.c. of 96 per cent. alcohol. One or two drops of this solution will serve as an indicator in testing a solution. Phenol phthalein, when used as an indicator, is red in alkaline solutions and colorless in neutral or acid solutions. It is a very delicate indicator. It can be used for the titration of both organic and inorganic acids and bases, but cannot be used for the titration of ammonia.

Methyl orange solution is made by dissolving 0.02 grams of solid methyl orange in 100 c.c. of distilled water. If a precipitate forms, the solution is filtered to free it from the precipitate. Two or three drops of this solution will serve as a sufficient quantity for testing a solution. Methyl orange is red in acid solutions and yellow in alkaline solution. Methyl orange cannot be used with weak acid or alkali solutions.

When we have a normal solution we have a solution of known strength. This can be readily seen from the definition of a normal solution. According to the definition, a normal solution of hydrochloric acid (HCl) will be 36.46 grams of hydrochloric acid gas dissolved in one litre of water. Then in one c.c. of a normal hydrochloric acid there is .03646 grams of hydrochloric acid gas, and a tenth normal will contain $\frac{1}{10}$ of this amount.

A normal sodium carbonate (Na_2CO_3) solution will contain 53.05 grams of sodium carbonate in one litre of water, and one c.c. of a normal sodium carbonate will contain .05305 grams of sodium carbonate. To make a $\frac{1}{10}$ normal solution from normal solution take 100 c.c. of normal solution and add 900 c.c. of pure distilled water. One tenth normal solutions are more frequently used than normal solutions.

WE WILL NOW SHOW HOW A NORMAL SOLUTION CAN BE USED.

Suppose we wish to find the strength of an acid. *e. g.* Sulphuric. Weigh out a small portion of the acid (about 2 or 3 gr.) in a clean beaker. Dilute with about twice its volume of water then add your indicator (phenol phthalein). Now in a clean dry burette pour normal or $\frac{1}{10}$ normal, sodium carbonate solution. Read the burette and allow the alkali solution to run into the acid until the acid is just neutralized as explained in making normal solution. The amount of alkali necessary to neutralize the acid is now known. And from the amount of alkali used to neutralize the acid we can easily determine the amount of acid in the acid solution.

The strength of an alkali solution can be determined in a similar manner as the acid solution.

When titrating alkaline carbonate solutions, it is advisable to use methyl orange instead of phenol phthalein as an indicator, because when methyl orange is used it is not necessary to boil the solution. In making the normal hydrochloric acid solution, with the aid of normal carbonate solution, add a few drops of methyl orange instead of phenol phthalein to the carbonate solution; the solution is then yellow, as soon as the solution turns pink enough, acid has been added; the carbonate solution is neutralized.

A normal sulphuric acid solution is made in a manner similar to the normal hydrochloric acid solution. Thirty cubic centimetres of chemically pure sulphuric acid is slowly added to three times its volume of water; when cool introduce into a litre flask and dilute to one litre. Standardize this solution with the normal sodium carbonate in the same manner as was done with hydrochloric acid.

(To be continued.)

A Swiss Process for Ungumming Raw Silk.

This process consists in conveying an electric current through the soap solution, whether the latter is used in the form of a lather or of a liquid bath, with which the raw silk (such as silk, silk waste, spun silk, fabrics of silk, or silk waste) is to be treated and whereby the duration of the treatment of the silk is considerably shortened.

HOW THE PROCESS IS CARRIED ON: Two electrodes of a material which is not affected by the soap solution, whether a lather or a liquid, and which is a conductor of electricity, are arranged in a suitable apparatus, the walls of which are non-conductors of electricity. The said electrodes are arranged at opposite sides of the apparatus, and in such a manner that they extend through the whole depth of the soap lather or bath, but do not come into contact with the silk to be treated.

These electrodes are connected up in an electric circuit so that the density of the current which circulates between them is from $\frac{1}{2}$ to 2 amperes and over per square decimeter (4 square inches) of electrode surface, while the tension of the current varies in accordance with the distance separating the said electrodes. For a distance of 44 centimeters ($17\frac{1}{2}$ "') the tension would be, for example, 120 volts. The electric current which circulates through the soap lather and eventually also through the soap solution beneath the same, or the latter only, considerably increases the action of the said lather or liquid so that the time requisite for softening or dissolving the gummy matter (sericin) on the silk is materially diminished, with the result, it is claimed, that the silk fibres acquire a higher degree of elasticity, greater strength and increased gloss, by reason of the reduced time during which it is maintained in contact with the soap solution. In either case, that is to say, whether the process is carried out by means of a soap bath or by soap lather, the conductivity of the bath or of the lather may be increased by a small addition of sodium phosphate or sodium acetate.

A New Process of Preparing Water for Dyeing.

This is a late patented process, having for its object to specially prepare the water used in the process of dyeing wool, silk or cotton, so that when mixed with the proper dyestuffs, it is claimed, the dyed material will offer a softer feel and a higher luster, besides holding the color more permanently.

To accomplish this, the inventor grinds oak (wood) and then mixes it with muriatic acid; the proportion, in bulk, of acid to wood to use being about 5:1. He then boils this mixture for about three hours, then lets it cool, after which he pours off the liquid, the resultant solid portion or pulp being then thoroughly washed, so as to rid the pulp of the acid.

The pulp is then placed in a suitable receptacle and enough water introduced to just about cover it, and having put in the water washing soda in proportion of about 15 lbs. of soda to 100 lbs. of the pulp, the mixture is boiled for about one hour. The mixture is then cooled, the liquid poured off and the resultant solid portion or pulp again washed until it is free of the soda.

The thus treated wood pulp is now put in a long cylinder in compressed condition and water forced through it, the pulp acting as a filtering body, not only mechanically abstracting from the water the impurities contained therein, but at the same time, chemically acting thereon.

The water so treated, when used in the process of dyeing textile fibres, it is claimed, very materially affects the latter so that a piece of goods, as for instance plush, when compared with another the water used in the dyeing of which has not been thus treated, will at once present a much higher luster, a softer feel, etc. Besides, the character of the fibres is so essentially affected that they not only better receive but more permanently hold the dye, due to the tannin left in a sparingly soluble form in the (oak) wood-pulp. If

this wood were not treated as described by the acid first, and then by the soda, the tannin at full strength in the oak-pulp would not be desirable and for a fact, materially discolor the material to be dyed when of a delicate light shade, while if the tannin were entirely neutralized or removed from the oak, the effect which it imparts to the water, *i. e.*, the softening thereof, and which produces the softer feel and higher luster obtained on the fabric, would be lost.

FULLING.

The Process and Modern Machinery.

(Continued from page x August issue.)

In the soaping of the goods, be careful that the moisture be just right, since either not enough or too much soap used will cause trouble. If the fabrics are running too dry, they will chafe and thus wear away the fibres, whereas if goods are running too wet, a soft, spongy fabric will be the result. When the moisture is right, the soap should start from the goods very slightly, when after stopping the machine you take hold of an end of the fabric and wring, *i. e.*, twist it rather hard with your hands. At the same time, notice the body of the soap as thus squeezed out of the fabric. If the same shows up thick and creamy, it is a sign of a good condition of the soap, where if by said wringing of the fabric the soap runs from the cloth thin and watery, add more soap in preparation, so as to secure more body for it.

Palm oil and a mixture of olive oil and tallow soaps have what is considered a *good body*, hence are valuable fulling soaps. The question of proper fulling soaps, however, is one which has not yet been scientifically answered.

We now might be asked, which is the best way to apply the soap to the cloth, and then the answer would be, to pour the requisite amount of soap on the goods in a slow and steady stream; however, it must be remembered that no matter which way the soap is applied and if all is put on at one time, such a thing as uneven soaping is impossible, since the fabric in its run through the mill, will distribute the soap all over the fabric.

Some mills apply the soap to the goods by what is known as a soaping machine, the same consisting of a soap tank in which the goods are immersed, a pair of squeeze rolls through which they pass thereby squeezing out all surplus soap which runs back into the tank. These squeeze rolls can be adjusted to suit the moisture required. This machine will start the grease, hence fulling begins more promptly in the mill.

The testing of soaps for fulling and scouring purposes will be fully treated in the chapter "*Analysis of Soap*" as will appear in the article on "*Testing Chemicals and Supplies, etc.*"

The Importance of using a Soft Water. The water as used in preparing the soft soap for fulling, must be taken into consideration, since if said water contains lime, salts of magnesia, etc., it will decompose the soap and consequently interfere with the fulling as well as the cleansing of the goods thus treated.

Some finishers may claim that the excess of soap, always given for a bath, will counteract the effect, but this is a mistake, not only on account of the loss of soap, but also that what is left is lime soap, which is of little or no use. Such soap during fulling will continually separate, and the cloth will, despite all efforts, have a harsh, raspy, dry feel. Examining the cloth during or after fulling will show no soap froth, but in place of it a thin, weak lye; again, soap has to be continually added, and even with this expensive

quicker, and will be more effective than if the fabric is allowed to lay in a wet condition for hours, or possibly for days. Now if this is the case when using a soft water, how much worse would it be if using a hard water. For this reason it must be remembered that the fulling of fabrics should under no circumstances be too far in advance of the gigging or napping process—both must go hand in hand for good results in the finished goods—and if for any reason the napping or gigging department falls behind the fulling department to any extent with their work, then the goods, after scouring, are better dried temporarily, especially when dealing with fabrics calling finally for a soft, pliable, velvety finish.

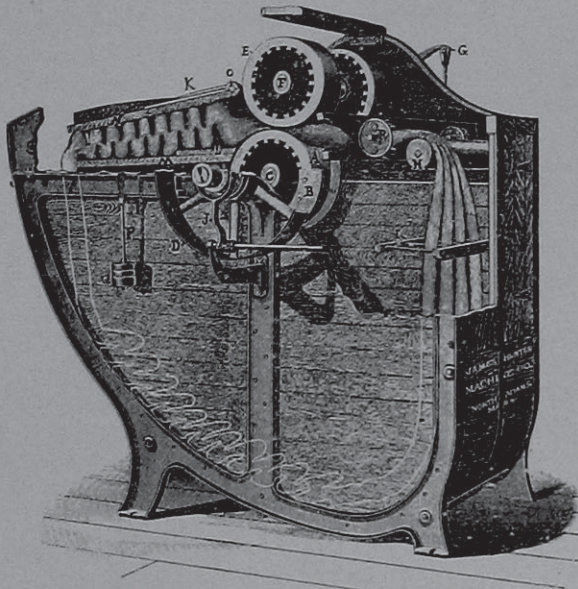

SECTION OF THE "HUNTER" FULLING MILL.

remedy, the cloth will continue dry. After fulling then comes the difficulty of trying to remove these additions by excessive washings, and finally the result, a hard, boardy fabric, too smooth to the feel or touch of the hand. The more fat there is used in the manufacture of the soap, the worse is the effect of hard water. Water only slightly hard may be softened by boiling, whereas very hard water, provided it is the only one at our disposal, may be softened by boiling, provided bran is added and which then is removed before using. *Gran. Carb. Soda*, as brought in the market by the Holbrook Mfg. Co., is an excellent medium for preparing hard water for fulling purposes.

In dealing with a fabric requiring gigging or napping, the influence of using a hard water is everlasting, for if the wool fibre is rendered hard by the water, the felt cannot be easily loosened on the gig or napper, nor can it, under any amount of work, be made as open and soft as it ought to be, or as it would be provided soft water had been used. If such a case occurred, the only way to remedy the trouble somewhat, is a free use of moderately warm condensed water. Soft water will even harden the goods if they are allowed to remain any length of time in a wet condition, and naturally hard water, under the same conditions will aggravate this trouble. This explains why any piece of cloth, if gigged or napped at once after fulling and scouring, can be handled easier,

The fulling process. After the goods have been soaped in the fulling mill, and allowed to run long enough for the soap to spread and evenly wet the goods, the time for their first examination has arrived. The goods running in the mill should be examined at stated periods to see if they come up even both ways, for if lacking in either respect, this must be attended to at once. If the goods do not come up in length as fast as they should, more weight must be applied to the trap, but if the supply should be exhausted, as will sometimes happen, then the pressure of the roll must be lessened, and in this way the shrinking sideways retarded, so that the goods may have a chance to come up lengthwise by the time they have sufficiently shrunk sideways. To assist the fuller in ascertaining readily the shrinkage of the fabric in its length, mark off one or more yards in the fabric by means of sewing different colored yarns in such places in the selvage before fulling. This will provide a ready guide for him during the process, although it will be advisable for him towards the end of the operation to measure the complete length of the fabric. After thus examining the goods, it is a good plan for the fuller to scrape off, more or less, any soap which has spattered on the sides and other parts inside of the fulling mill, and put such soap back on the goods, thus not only keeping the inside of the mill in a better condition, but at the same time use the soap to its full value. Soap, if deposited in quantities and for time on the metal parts of the machine tends to corrode them, and if left on them to dry, will form a hard scum which in time will become detached and fall on the goods, and in passing through the rolls is apt to do damage, however slight it may be. The accumulation of soap on the wooden parts of the machine will exert a tendency to warp them more or less, a feature readily seen when the doors of the machine will shut hard, hinges rust off, etc.

Pressure in a fulling mill for shrinking the fabric either way must be put on easy and a little at a time; this will be found far better than putting on full pressure at once, for the fact that if shrinking the cloth too suddenly, good felting is lost sight of. By taking this precaution, the goods, when finished, will not look starved, nor handle hard and wiry. If the goods shrink too slowly in width, a little additional pressure put on to the top roll will help the same as additional weights on the trap will help to shrink the fabric in

its length, and vice versa in both instances. The most perfect work, from side to side, can be secured where the piece is tacked, *i. e.*, the selvages sewed together. This was formerly only done when flocking the goods, but upon heavy goods it tends to give all parts of the fabric under operation an equal chance to full, whereas without tacking there is a tendency for the selvages to remain on the outside of the folds, keep cooler, and consequently felt less than the middle of the fabric, which retains a higher temperature during the process, being more compact in running.

Provided fabrics come up continually too fast in their length, it is a good plan to somewhat draw down the rods of the elliptic springs, and thus increase the pressure of the rolls. But if this does not help, then the best plan is to double such pieces in the mill, thus increasing the volume of cloth at one time under the influence of the rolls (more pressure exerted) and at the same time shortening the piece by one-half, and when consequently the goods will be under the roll oftener than if they were single.

On light weights, two (or three) pieces side by side, are generally run in the mill, in this way not only increasing the production, but at the same time the goods will run better all around.

Provided a fabric requires heavy fulling, take it out of the mill occasionally, open it up and stretch it widthways, so as to smoothen it and then enter it again in a change of position or folds, increasing the felt and guarding at the same time against wrinkles. With lower grade of goods and quick fulling fabrics, this procedure is not necessary.

Cockles although they may be made elsewhere than in the fulling mill, at the same time, are also apt to be made there. Uneven soaping may be the cause, *i. e.*, having the pieces run too dry, and then where the soap goes on directly, the grease will start, whereas the parts that have to depend upon soap, by absorbing from the more moist places, will not get enough to start the grease, and therefore the piece fulls unevenly.

Roping is a trouble the fuller may often have to contend with. It refers to the rolling and roping of the fabrics while in the fulling mill, caused possibly by a peculiar or a faulty construction of the cloth, the selvages, etc. In some instances it may be hard to prevent this trouble, still whenever it is noticed, stop the fulling mill, take the goods out and open them, after which run them in the mill again, but in the reverse way from which they run first, after which sew them together and start them, adding a little fresh soap, however being careful not to run them too wet. You may have to repeat this procedure in some instances.

Another trouble which will come under the notice of the fuller, is that the pieces may choke up behind the trap, forming themselves into a hard lump. More particularly will this occur when dealing with tight, firmly woven, medium and heavy weight goods. If such an affair is noticed, let the trap down about half way. If you have to run a piece double in the mill, measure for half its length, tie a string around the piece and run the latter into the mill until this place

appears, and then enter the first end again, tying it again to the fabric and running the latter until the end comes around, and then pull out the first end and sew the two ends of the fabric together. This will prevent trouble, since the fabric is evenly divided through its run in the mill. Provided a fabric has to be run three-fold in the mill, divide its length in three parts and proceed as before, and then in the same way with the third section of the cloth.

Modern fulling mills are provided with stop motions. They are most simple in construction, being nothing more than having the guide plank in the front part of the mill connected by a rod, etc., to the lever which operates the clutch driving mechanism, of the machine. The cloth when thus bunching, raises the guide plank and thus operates the stop motion in a most simple way. Be sure that the stop motion works properly and thus prevent the goods from being chafed by the rollers when working on a stationary fabric, and when they cannot help but wear out the latter in this place, in extreme cases, by carelessness of the fuller, going as far as wearing holes in the cloth.

As soon as the fabric is up in its width and length, the fuller must test the soap in the fabric, and in every piece, provided two or more fulls at one time, to see if it has turned watery or not. When the pieces are handled, and a gentle squeeze given, a little free soap should appear, this is a test that sufficient soap has been used, or that the soap has not lost its vitality by too long fulling. This test should not be omitted, since it will save trouble. In any case where the soap does not show up as thus mentioned, give the pieces an additional dipperful of soap before taking them from the mill, which will then help them in the washer.

When the fabrics are taken out of the mill, remove the tacking strings, provided the goods had been tacked, after which, unless they can go at once in the washer, open them out so that the air can get at all parts of the fabric, since they are then warm and if left lying in piles would start the colors and thus dullen them. Such an airing, in connection with goods to be piece dyed, will also prevent the formation of streaky and cloudy places in such fabrics.

If goods are flocked, all the flocks and waste matter coming from the mill must be taken care of, *i. e.*, away from the machine—to wherever they belong.

(To be continued)

BLANKET BLEACHING. Blankets should never be bleached by stoving, as the same thing can now be done quite as cheaply with *peroxide of sodium*, which has the advantage of not altering any dyes which may be in the blanket. The bleach bath is prepared by stirring 135 lbs. of concentrated sulphuric acid gradually into 2,000 gallons of water, and then 100 lbs. of the peroxide, more or less. The bath must be still feebly acid. Then make it slightly alkaline with water glass, and heat it to 95 deg. F. The goods will be perfectly bleached after about 12 hours in this bath.

MILL NEWS

Philadelphia, Pa. Almost the entire west wing of the Overbrook Carpet Company's plant at Fifty-sixth and Jefferson streets was destroyed by fire, August 26, resulting in a loss of \$250,000.

David Greer Orme, manufacturer of fancy worsteds, is starting up looms as fast as warps can be made for them.

After a shutdown of three weeks, the hosiery mill of William Taubel is now being operated full time, with a full complement of employees.

Richard J. Prince, manufacturer of dress goods, Tenth and Diamond streets, is operating all looms to their fullest capacity.

The Wright & Hall Textile Company has all its broad looms and nearly all its narrow looms running on full time.

A. J. Cameron & Co., manufacturers of worsted and woolen yarns, are operating their plant to its fullest capacity.

The Devon Carpet Mills are very busy in their art square department, with all looms running full time.

James A. O'Connell, formerly of the Marion Hosiery Mills, is now occupying the fourth floor of the old Empire Mill at Huntingdon and Kensington avenue. He will make ladies' fine gauge seamless hosiery.

George W. Lefferts, formerly superintendent at the Tracy Worsted Mills, is starting up a worsted spinning plant at Twenty-third and Hamilton streets. The concern will be known as George W. Lefferts & Co., and will start up with 1,162 spindles and the necessary gill boxes, drawing frames, etc., employing the usual complement of hands. Work will be on the Bradford system up to 2-32s, both knitting and weaving yarns will be spun.

The Belvue Worsted Mills, of Germantown, which have been shut down for several weeks, have started part of their machinery.

Reading, Pa. The Prospect Dye Works are running on full time with the usual force of employees.

The Reading Cotton Mill, Garner & Co., which have been running on half-time for three months, went on full time.

The Mount Penn Underwear Co. is working overtime in order to fill orders.

The Hampden Knitting Mills Company is running full time, and is in need of ribber and looper operatives.

Norristown, Pa. Rambo & Regar, proprietors of the Globe Knitting Mills, are exceptionally busy, operating their entire plant to its fullest capacity.

Royersford, Pa. The McKibban Ho-

siery Company has incorporated with a capital stock of \$5,000.

Easton, Pa. The Chipman hosiery plant, working on half-time since June, is being operated on full time, with a force of 400 operatives.

Etnaus, Pa. Permits have been issued for the erection of a new silk mill, 45 by 70 feet, on Ridge street.

Chester, Pa. The Eddystone Print Works, Aberfoyle, and Murphy & Bro.'s mills are working full time.

Mauch Chunk, Pa. The Mauch Chunk Silk Company will erect an extension to their mill.

Marietta, Pa. The Ashley & Bailey Company's silk mill has resumed operations on full time.

Paterson, N. J. The Colonial Silk Company has been incorporated with a capital stock of \$30,000.

General Joseph Congdon, ex-president of the Silk Association of America, it is reported admits that he is to resign from the presidency of the Phoenix Manufacturing Company, but intends to remain on the board of directors of the Phoenix Company, one of the largest silk concerns in the country.

The A. H. Hart Company, of New York, has taken possession of the Granite Mill on Grand street, and will engage in the manufacture of linen, twines, threads and yarns of all descriptions. It is expected that operations will be started by October, giving employment to about 400 hands.

Camden, N. J. William Lund & Son, manufacturers of worsted yarns, are running on full time and expect a busy season.

The Nelson Manufacturing Company has incorporated with a capital stock of \$100,000, to manufacture and sell knitted fabrics, lawns and cloths.

Trenton, N. J. The Princeton Worsted Mills has increased the working force from 200 to 300 operatives. The increase in the working force is made necessary by the growth of business in the last few months.

Boonton, N. J. A calico printing concern is being established here by Davis & Catterall, and will be known as the Catterall Printing Company, with a capital stock of \$25,000. The works will be run on fly cloth, bunting and fancy prints.

Hackensack, N. J. The plants of the De Gray's and Norfolk Silk Mills are running overtime.

Phillipsburg, N. J. John Ramsay & Sons, of Paterson, who recently purchased the W. H. Ashley Silk Company's mill here, are arranging to double the present capacity of the plant.

Ashland, Md. Operations have been resumed in the cotton and woolen plant of the Ashland Manufacturing Company

under new ownership, with an equipment of 8,710 spindles and 85 looms, on kerseys, cheviots, cassimeres and overcoatings.

Wilmington, Del. The Empire Silk Company has incorporated with a capital stock of \$1,000,000.

Utica, N. Y. The No. 1 mill of the Utica Knitting Company is reported running 50 hours a week, while the No. 4 mill is running 55 hours. Nos. 2 and 3 will be placed on a 55-hour schedule within a short time, and possibly 60 hours.

The Oneita Knitting Mills are running on a five-day schedule.

Cohoes, N. Y. The Atlantic Mill, operated by the Roff Underwear Company, is being operated day and night, and gives employment to over 250 hands.

Gouverneur, N. Y. The Gouverneur Lace Mill has resumed operation and the output of the plant will be increased as the trade warrants until it is in full blast again.

Rome, N. Y. The knitting mill of the Williams Brothers Company has resumed operations on full time and with a full force, after having been shut down for several months.

Hamilton, N. Y. The Hamilton Hosiery Mills have incorporated with a capital stock of \$30,000, and will manufacture hosiery, underwear, etc.

Philmont, N. Y. The plant of the Columbia Mesh Knitting Company, which has been shut down for some time, has resumed operations.

Boston, Mass. The plants of the Roxbury Carpet Company and the Saxonville Mills, both of which were practically shut down for the past two months, have returned to full time.

New Bedford, Mass. Another new \$50,000 spindle fine goods mill is being planned to be located at the south end. Walter H. Langshaw, president of the Dartmouth Mill, is interested in this new enterprise.

The new Manomet No. 2 Mill, which will employ about 1,400 operatives, is in operation. It is claimed that it will be the largest individual consumer of cotton in the city, using 40,000 bales a year.

The Dartmouth Manufacturing Corporation will erect a one-story building of brick and concrete construction, 137 by 63 feet, single story, for the purpose of providing additional quarters for its picker mill.

Adams, Mass. The Arnold Print Works has returned to a full time basis.

The Renfrew Manufacturing Company is operating with all its hands on full time for the first time since April and have a great accumulation of orders on hand.

(Continued on page xvii)

BUYERS' INDEX—Continued**Logwood Crystals.**

West Indies Chemical Works, Ltd.

Logwood Extracts.

West Indies Chemical Works, Ltd.

Looms.Crompton & Knowles Loom Works.
Draper Co.
Kilburn, Lincoln & Co.
Mason Machine Works.
Whitin Machine Works.**Measuring Devices.**Draper Co.
Sipp Electric & Machine Co.**Metallic Rolls.**

Metallic Drawing Roll Co., The.

Mohair.Littauer, Ludwig.
Queensbury Mills.**Mules.**

Mason Machine Works.

Patent Attorneys.

Howson & Howson.

Peroxide of Sodium.

Roessler & Hasslacher Chemical Co.

Pneumatic Conveyors.

Philadelphia Drying Machinery Co.

Power Transmitting Machinery.

Philadelphia Drying Machinery Co.

Presses.Philadelphia Drying Machinery Co.
Woonsocket Machine & Press Co.**Printing Drums.**

Crompton & Knowles Loom Works.

Pumps.

Philadelphia Drying Machinery Co.

Quillers.Sipp Electric & Machine Co.
Whitin Machine Works.**Railway Heads.**Mason Machine Works.
Whitin Machine Works.**Reeds.**

Whitaker Reed Co.

Reels.Draper Co.
Sipp Electric & Machine Co.
Whitin Machine Works.**Revolving Flat Cards.**Mason Machine Works.
Whitin Machine Works.**Ribbons and Piece Silks for Trimming
Knit Goods.**Cheney Bros.
Sauquoit Silk Mfg. Co.**Shuttles.**

American Textile Specialty M'ch'y Co.

Silk Machinery.Altemus, Jacob K.
Crompton & Knowles Loom Works.
Halton's, Thomas, Sons.
Mason Machine Works.
Sipp Electric & Machine Co.**Silk Yarns.**Cheney Bros.
Littauer, Ludwig.
Ryle, William, & Co.
Sauquoit Silk Mfg. Co.**Sizing Compounds.**

Cummings, J. W.

Spindles.

Draper Co.

Spinning Frames.Mason Machine Works.
Whitin Machine Works.**Spinning Rings.**Draper Co.
Whitaker Reed Co.**Spoolers.**Draper Co.
Whitin Machine Works.**Tanks and Tubs.**

Philadelphia Drying Machinery Co.

Tapes, Braids and Edgings.Chapin, George W.
Weimar Brothers.**Temples.**Crompton & Knowles Loom Works.
Draper Co.**Threads.**Chapin, George W.
Littauer, Ludwig.**Thread Guides.**Palmer, The I. E. Co.
Whitin Machine Works.**Tinsel.**

Littauer, Ludwig.

Twisters.Draper Co.
Mason Machine Works.
Whitin Machine Works.**Winding, Beaming and Warping Ma-
chinery.**Altemus, Jacob K.
Draper Co.
Lever, Oswald Co., Inc.
Sipp Electric & Machine Co.
Whitin Machine Works.**Wool, Hair and Skins**

Northeastern Trading Co.

Wool Combers.

Crompton & Knowles Loom Works.

Woolen Machinery.Altemus, Jacob K.
Crompton & Knowles Loom Works.
Hunter, James, Machine Co.
Lever, Oswald Co., Inc.
Philadelphia Drying Machinery Co.
Woonsocket Machine & Press Co.**Woolen Yarns.**Littauer, Ludwig.
Queensbury Mills.**Wool Washing Machinery.**Hunter, James, Machine Co.
Philadelphia Drying Machinery Co.**Worsted Yarns.**Campion, Richard.
Griswold Worsted Co.
Littauer, Ludwig.
Queensbury Mills.**Yarn Testing Machinery.**

Sipp Electric & Machine Co.

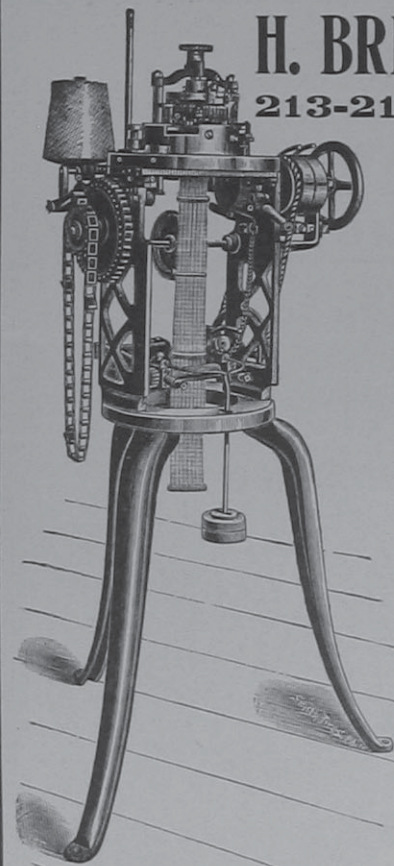

H. BRINTON CO.
213-215 Race St.
PHILADELPHIA, PA.

—BUILDERS OF—
**KNITTING
MACHINERY**
for
**HOSIERY
and
UNDERWEAR**
COMPLETE
ESTIMATES
FURNISHED

The Cut shows our
**IMPROVED
AUTOMATIC
RIBBER**

with Welt and Slack Course for Half Hose Tops and Ribbed Legs.

IF YOU WANT

**Superintendents,
Overseers,
Second Hands, Etc.,**
WOOL—COTTON—SILK

For any department of the mill and for any class
of goods write to our

**TEXTILE WORKERS'
BUREAU**

We are in constant communication with the most
competent men in the various lines, throughout the
world, who can furnish excellent references from past
employers.

ADDRESS:

POSSELT'S TEXTILE JOURNAL
2028 Berks Street - - - PHILADELPHIA, PA.

GEORGE W. CHAPIN
COTTON YARNS

TAPES, BRAIDS, THREADS
LACE EDGINGS

229 CHURCH STREET 231
PHILADELPHIA, PA.

N. Y. Office, 350 Broadway

R. E. SCHNEEBELI, Res. Manager

LUDWIG LITTAUER

Successor to Moeller & Littauer

**Y
A
R
N
S**

Thrown Silk
Artificial, Shappe and Spun Silk
Domestic and Imported, Plain
Gassed, Mercerized and Polished Cotton
Polished and Glazed Threads
Mohair and Worsted
Tinsel
Turkey Red

**Y
A
R
N
S**

109 GREENE ST., NEW YORK

Best Quality Harness Twine

Alex. D. Stelle, President

Walter H. Rossmässler, Treasurer

Sauquoit Silk Mfg. Company

MANUFACTURERS OF
ORGANZINE, TRAM, TWIST
FRINGE AND HOSIERY SILKS

Fast Dye Organzines for Woolen Manufacturers a Specialty

Mills: BETHLEHEM, PA.
PHILADELPHIA, PA.
SCRANTON, PA.

New York Representatives: WILLIAM RYLE & CO., 54 Howard Street
PHILA. OFFICE: 4015 Clarissa St. (18th St. & Hunting Park Av., Nicetown)
CHICAGO OFFICE: 188 Market St. BOSTON OFFICE: 78 Chauncy St.
Silks For Insulating Purposes

WILLIAM RYLE & CO.

Foreign and Domestic

Spun Silk Yarns and Noils

Domestic Thrown Silk of every description. Fine Pure Dye Silks for the woolen trade a specialty. Importers of European and Asiatic Raw Silk

54 Howard St. NEW YORK

FIRTH & FOSTER CO.
DYERS and FINISHERS

OF PIECE GOODS EXCLUSIVELY

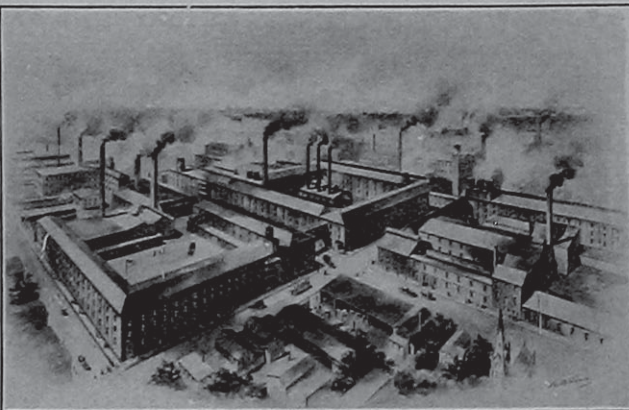

The best equipped plant for the DYEING and FINISHING of fine wool and worsted goods, also silk and wool fabrics.

EMERALD, YORK AND ADAMS STREETS

PHILADELPHIA

NEW YORK OFFICE: Silk Exchange Bldg., Room 702

QUEENSBURY MILLS

H. HODGSON, Pres. and Treas.

FRED. HODGSON, Gen. Mgr.

MOHAIR

FLYER
SPUN
YARNS

*Mohair Tops
and
Yarns for Weaving
Single and 2-ply*

ALPACA
AND
WORSTED
YARNS

WORCESTER, MASS.

ESTABLISHED 1866
INCORPORATED 1888

A. H. HOWARD, PRES. AND MGR.
HERBERT MIDGLEY, SUPT.

HOWARD BROTHERS MFG. CO.

MANUFACTURERS OF

CARD CLOTHING

Hand Stripping Cards, German and Domestic
Heddles for Cotton and Woolen Mills
Revolving Top Flats Remounted
Fillets Redrawn

PHONE 1070. LOCAL AND LONG DISTANCE

44 and 46 Vine Street, Worcester, Mass.

QUALITY SELLS OUR GOODS

Griswold Worsted Co.

WORSTED YARNS

= OF =

QUALITY

MILLS & OFFICE

DARBY, (Del. Co.) PA.

Yates's Patent AUTOMATIC SHUTTLE GUARD

Over 800,000 now in use in Great Britain and foreign countries. Adapted for all makes and widths of looms.

TIMOTHY YATES, Richmond St., Preston, Lancs., England (Only Address).

Agents wanted in weaving centres in the United States

"GLAZINE" For Softening, Filling White and Colored Goods, and Giving a Bright Finish

Inquiries: **J. W. CUMMING**, Irish Moss Exporter
Clonliffe, Dublin

Code Used A, B, C, 5th Edition

Telegrams: Cumming, Dublin

FREDERICK JONES & CO.

Race above Fourth Street, Philadelphia

TEXTILE DESIGN PAPERS

for all Fabrics

Dyeing Colors for Flags.

The colors on flags and banners must be fast, since their use involves exposure to the weather, and the nature and distribution of the colors upon them is of the greatest importance. The dressing must be light, only enough to prevent the fabric from being too limber. Glue, made insoluble in water by means of bichromate, is considered the best dressing, using for 500 yds. of ordinary twilled goods, 30 in. wide, from 4 to 5 lb. of glue and about 4 oz. of bichromate of soda. When the thus dressed fabric is then exposed to light, the bichromate fixes the gelatine, and enables it to stand exposure to rain and wind as long as the material itself will last.

With reference to dyeing, Sulphur blacks are the

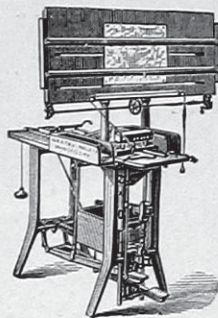

F. G. LENTZ & CO.
Designers, Card Stampers
and Harness Builders
FOR ALL TEXTILE FABRICS
Mascher, Waterloo and York Sts.
Both Phones PHILADELPHIA, PA.

best for black-dyeing. For blue, Indanthrene cannot be surpassed, and is easily dyed in the hydrosulphite vat. For red it is best to use Turkey-red.

There will be found more difficulty with green, says the *Deutsche Färber Zeitung*, especially since green on flags and banners has usually to be light in shade and yet brilliant and striking. There is no substantive green sufficiently fast for our purpose, and we are therefore compelled to resort to the basic dyes. The mordanting must be thoroughly done, and the dyeing cannot be better done than with equal parts of Methylene Blue B B and New Victoria Green, shading with Fast Yellow. After dyeing, a second bath of tannin and antimony is very advisable.

Yellow on flags is best dyed with chrome yellow, obtained by means of sugar of lead and bichromate of soda. If an orange is wanted, the chrome yellow is topped with a suitable quantity of Diamine Orange. Preliminary bleaching of the fabric is only necessary for very light shades.

WORSTED YARNS
RICHARD CAMPION

Selling Agent for
BRISTOL WORSTED MILLS
HIGHLAND WORSTED MILLS
300 Chestnut Street - PHILADELPHIA

CHEMICALS AND APPARATUS
FOR THE DYE TRADE

J. & H. BERGE
Best Bohemian Chemical Glassware and German Porcelain.
C. P. Chemicals and Reagents, Chemists' Supplies of all kinds.
95 JOHN STREET, - - NEW YORK

KILBURN, LINCOLN & COMPANY
LOOMS FOR
COTTON AND SILK WEAVING
FALL RIVER, MASS.

HOWSON AND HOWSON
ATTORNEYS AT LAW

West End Building, 32 S. Broad Street
Philadelphia
SOLICITORS OF PATENTS New York, 38 Park Row
Washington, 918 F Street

The number is ever increasing.
There is a good reason why.

THE SCHAELLIBAUM GRID

The grid with a comb is getting
in general use all over the country.
It does the work. You get
better cleaning and lose less
cotton in the process than by
any other grid : : : : :

The ROB. SCHAELLIBAUM CO.
288 Dyer Street, Providence, R. I.

The West Indies Chemical Works, Limited
Manufacturing Only the One Product

PURE LOGWOOD
EXTRACTS

WE ARE ABLE TO GIVE YOU THE BEST
WORKS—JAMAICA, WEST INDIES
(where the Logwood Grows)
NEW YORK OFFICE, 84 WILLIAM ST.

OSWALD LEVER Co., Inc., BUILDERS OF
TEXTILE MACHINERY

Lehigh & Mascher Sts. **PHILADELPHIA, PA.**

SPECIALTY: WINDING MACHINERY IN ALL VARIETIES
FOR ALL CLASSES OF WORK

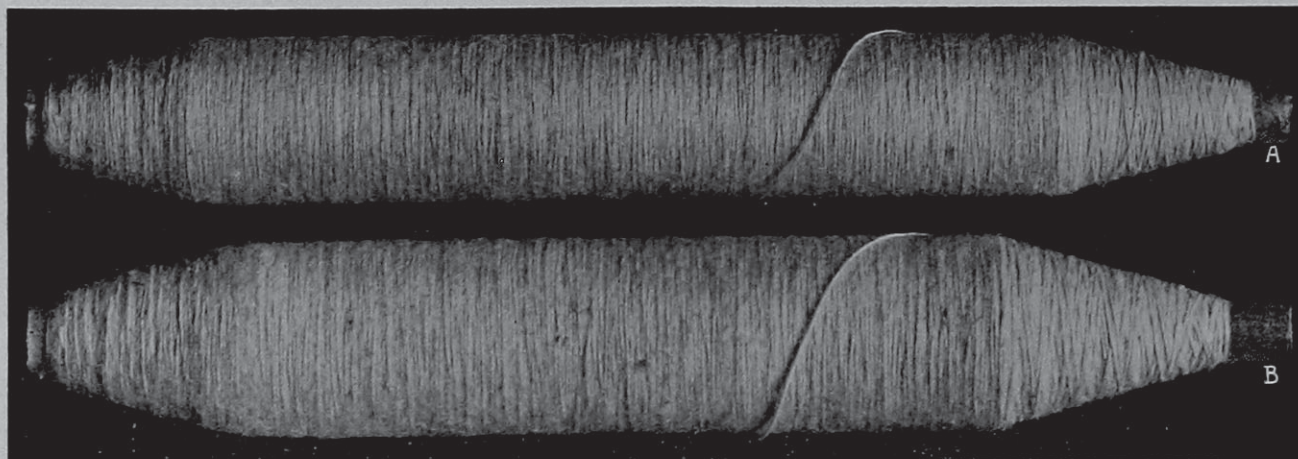

Illustrations, Actual Size, Showing What We Do. We Invite Comparison.

Send Samples for Rewinding
and We will convince you
Where you are short.

- A:** Single 25's soft spun Cotton Yarn.
Amount of yarn on tube 456 grains or 1368 yards.
- B:** Single 12's soft spun Cotton Yarn.
Amount of yarn on tube 458 grains or 660 yards.

AMERICAN TEXTILE SPECIALTY MACHINERY CO.

MANUFACTURERS OF

Shuttles and Shuttle Irons for all Textile Purposes

NEVER-SLIP COP SPINDLES AND TUBES

N. Y. Office, 363-373 Rider Ave.

670 Eddy St., PROVIDENCE, R. I.

Announcement:

We beg to announce that in the interest of *our Advertisers* we have facilities for Exhibiting smaller classes of Machinery, Working Models, Supplies and Devices Relating to the Textile Industry; to look after their interest and demonstrate advantages.

For the convenience of the practical men and the busy manufacturers, the Exhibit will be open from 8.30 A. M. to 5.30 P. M. daily and every Tuesday from 7 to 10 P. M.

Full particulars on request.

POSSELT'S TEXTILE JOURNAL, Philadelphia.

The Berkshire Cotton Mills are running on the full time basis.

The Adams Woolen Company are running day and night.

Clinton, Mass. After running four days a week since spring the Bigelow Carpet Company have gone on a five days a week basis. Mr. Paul F. Wise, of Malden, Mass., has been appointed agent of the concern.

Ware, Mass. The new addition to the No. 4 mill of the George H. Gilbert Manufacturing Company has been completed, and the plant is now in operation.

North Chelmsford, Mass. The mills of the Moore Spinning Company are again running on full time. Part of the mill has been closed for several months, but orders are coming in.

Millbury, Mass. The United States Linen Company, which has been idle since spring, has bought fifty tons of stock and it is reported will probably start within a short time.

Thorndike, Mass. An addition, 120 by 35 feet, three stories high, is to be built to the picker building of the No. 2 mill of the Thorndike Company. An additional story, it is reported, will also be built to the main building of the plant.

Webster, Mass. The South Village Woolen Mill, owned by S. Slater & Son, Inc., has resumed operations on full time, giving employment to 1,000 hands.

Fall River, Mass. The addition to the plant of the Richard Borden Manufacturing Company will consist of 10,000 spindles to the present equipment of 96,000 spindles.

Lowell, Mass. The Hamilton Manufacturing Company and the Massachusetts Mills, employing 4,500 have resumed operations after a short close down.

Chicopee Falls, Mass. Jos. T. Ogozalik, a banker and steamship agent here, claims that in the eleven years he has been in business he alone has forwarded

for the Poles working in the mills here over \$5,500,000 to their relatives in Europe, all of which was earned in the textile mills here by the Poles. As a rule, they do not spend their money with the American merchants, but trade amongst themselves.

South Groveland, Mass. The Groveland Woolen Mills, which have been closed for a month on account of the business depression, have resumed operations.

Providence, R. I. The Earnscliff Mill is running full time and have again put on the night shift.

The four big mills of the Fletcher Manufacturing Company, manufacturers of woolen and worsted goods, which have been shut down almost completely for the last several months, resumed operations with between 400 and 500 of the 760 employes. The receipt of many good sized orders is the reason given for the resumption.

(Continued on page xiv.)

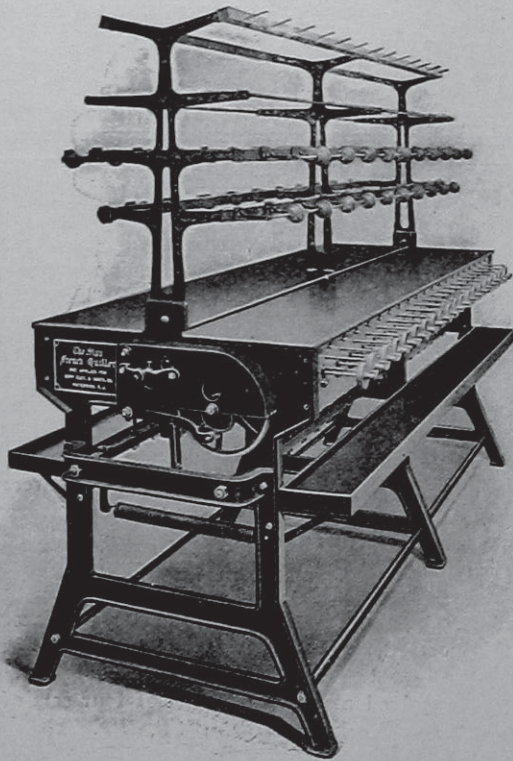

The Sipp High Speed French Quiller Patented

The QUILLER that Will Produce More

GOOD QUILLS IN LESS TIME

Than Any Other QUILLER Made

$\frac{3}{4}$ of the raw silk quilled in the United States is wound on these machines, aside from their use for soft silk and cotton yarn. : : : : :

Prices and Circulars on Application to

THE

Sipp Electric and Machine
Company

Keen and Warren Streets and Erie R. R.

PATERSON, N. J.

Cost and Accounting Systems
Periodical or Casual Audits

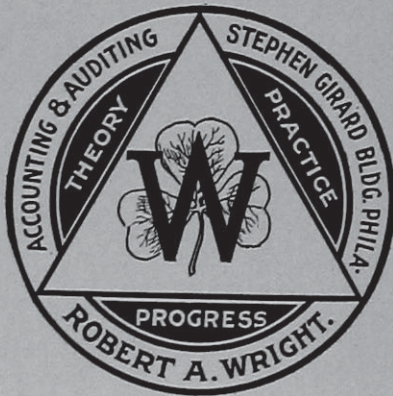

Consultations and
General Accounting

WEIMAR BROTHERS
MANUFACTURERS OF
Tapes, Bindings and Narrow Fabrics
2046-48 AMBER STREET
PHILADELPHIA

WHEN QUALITY COUNTS WE GET THE ORDER



Cuts in this Journal are a sample of our work.

ESTABLISHED 1869 INCORPORATED 1906
The Whitaker Reed Co.
MANUFACTURERS OF
LOOM REEDS OF ALL KINDS
"Royal" Ring Travelers, Mill Wire Goods and Heddles
Worcester, - - Mass.

THEODORE H. STROUSE & CO. 426-428 MARKET STREET, PHILADELPHIA, PA. COTTON YARNS, MERCERIZED AND PLAIN. FINE SINGLE, TWO AND THREE PLY UP TO 200's.

Sole American Agents for Messrs. Wm. A. Holt, Ltd., Cotton Spinners and Doublers, Bolton, England.

The Warburton Thread Company have incorporated with a capital stock of \$50,000 and will manufacture and sell silks, cotton, linen and woolen threads and yarns.

The Vesta Knitting Mills, manufacturers of ladies' and children's underwear, are reported as running day and night.

Pawtucket, R. I. The American Textile Company, manufacturers of cotton and silk laces, have ordered machinery from France and England that will double their present output.

Olneyville, R. I. The plant of the Rhode Island Worsted Company, which has been idle several years, it is reported, will soon be started up as the Elston Worsted Mills. Mr. Elston, formerly connected with the Colwell Worsted Mills, will be in charge of the plant.

Shannock, R. I. The Columbia Narrow Fabric Company will build an addition, 144 by 54 feet, one story high, which will be used as a weave shed, to be completed by November 1.

South Manchester, Conn. The Cheney Brothers Company, the greatest silk manufacturing establishment in the United States, has gone on full time, 60 hours a week. Orders are coming in encouragingly. They are transferring the machinery of their Hartford plant to their new mills here. They also will add new machinery, and their ribbon department will have a greater capacity than heretofore.

Central Village, Conn. The Central Worsted Company is running four nights a week until 9 o'clock.

Woolen mills here and in this vicinity have resumed work on full time, with orders ahead that will keep them going for some time.

Yantic, Conn. The Yantic Woolen Company is running full time with full hands.

Middletown, Conn. The Russell Manufacturing Company, manufacturers of cotton and silk webbing, has increased the weekly running time of its plant from fifty to fifty-five hours.

Sanford, Me. The Goodall Worsted Company and the Maine Alpaca Company have been consolidated and will hereafter be known as the Goodall Worsted Company, with a capitalization

of \$1,000,000. About 1,500 persons will be employed.

Saco, Me. The York Manufacturing Company, who have been running on short time practically all summer, have returned to a full time basis.

Dover, N. H. The Sawyer Woolen Mills, which have been running on very short time since early last fall, have returned to a full time basis.

Exeter, N. H. The Exeter Manufacturing Company, whose mill is closed for repairs, is at the same time installing 500 new looms; the mills are expected to resume operations in a few days.

San Francisco. The richest cargo of raw silk imported from the Orient for several years reached this port August 29 on the steamer Asia.

It consisted of 2,660 bales, valued at \$2,000,000, and was sent to New York on a special train, in waiting at the dock when the Asia arrived.

Seattle, Wash. The steamship Minnesota arrived August 9th with 1,800 bales of Japanese silk, valued at \$1,000,000.

Marquette, Mich. A woolen mill is to be established at Pickford, Chippewa County. The output of the factory will consist of lumbermen's goods, tweeds, flannels and cloths of similar kind.

El Reno, Okla. The Canadian Cotton Company has been incorporated with a stock of \$50,000.

Milwaukee, Wis. The Western Woolen Mills, which incorporated recently with a capital stock of \$25,000, have equipped their plant with sixteen broad looms for making high grade worsted cloths, blue and black staples and serges.

Cleveland, Ohio. The Standard Knitting Company, manufacturers of sweaters and fancy knit goods, is running its plant day and night.

Louisville, Ky. The Falls City Woolen Mills are increasing their equipment by an additional twenty-five looms.

Thomas Williams, formerly manager of the Hope Worsted Mills, has completed the organization of a company to manufacture worsted yarns. Three thousand five hundred spindles and other necessary machinery will make up the equipment.

Chattanooga, Tenn. The Buster Brown Hosiery Company has been incorporated with a capital stock of \$5,000.

Rockwood, Tenn. The Rockwood Mills will double their capacity, which is four hundred dozen pairs of hose daily. The equipment consists of 53 knitting machines, besides dyeing and finishing equipment.

Norfolk, Va. The Norfolk Knitting Mills, which have been closed for some time through lack of business, have resumed full operations.

South Boston, Va. The Century Cotton Mills, manufacturers of 10's to 30's hosiery yarns, it is reported, will add additional machinery to their present equipment of 8,000 spindles.

Bennington, Va. E. A. Smith and E. H. Smith are fitting up a small hosiery mill for the manufacture of stockings of all grades. The equipment will temporarily consist of four sets of machines.

Bedford City, Va. The Bedford City Mills Company, the output of which is controlled by the Thos. Kent Mfg. Co. of Clifton Heights, Pa., has decided to build an addition to its present plant, 77 by 55 feet, to be equipped with the latest type of woolen machinery. These improvements are made necessary by the award of large Government contracts to the Thos. Kent Manufacturing Company.

Charlotte, N. C. The Kerr Bleaching and Finishing Works, which was recently damaged by fire, will be rebuilt at once, and new machinery installed. The plant was employing 100 operatives and had a daily capacity for bleaching, dyeing, napping and finishing 20 tons of cotton piece goods.

Charlotte, N. C. Charlotte is soon to have a new industry in the form of a towel factory. Machinery is being placed on one half of the second floor of the Tompkins building by Alexander & Garsed, machinery agents for the parties who will manufacture towels.

Cumberland, N. C. Mill No. 2 of the Cumberland Cotton Mills, controlled by J. Fred Houston & Co., of Phila., is nearly completed and will be equipped with 5,000 spindles for the production of hosiery yarns, about doubling the present plant.

Kinston, N. C. The Orion Knitting Mills has increased its capital stock from \$10,000 to \$100,000.

Cornelius, N. C. The Gem Yarn Mill is building an addition to their present building to make more room for addi-

(Continued on page xvi.)

We are prepared to prove that Peroxide of Sodium for

Bleaching

animal & vegetable fibres or their mixtures is the best.

Roesler & Hasslacher Chemical Co. New York

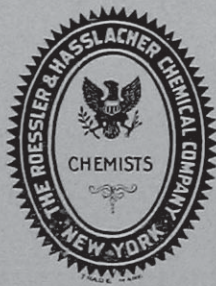

WOONSOCKET YARN GASSING MACHINE

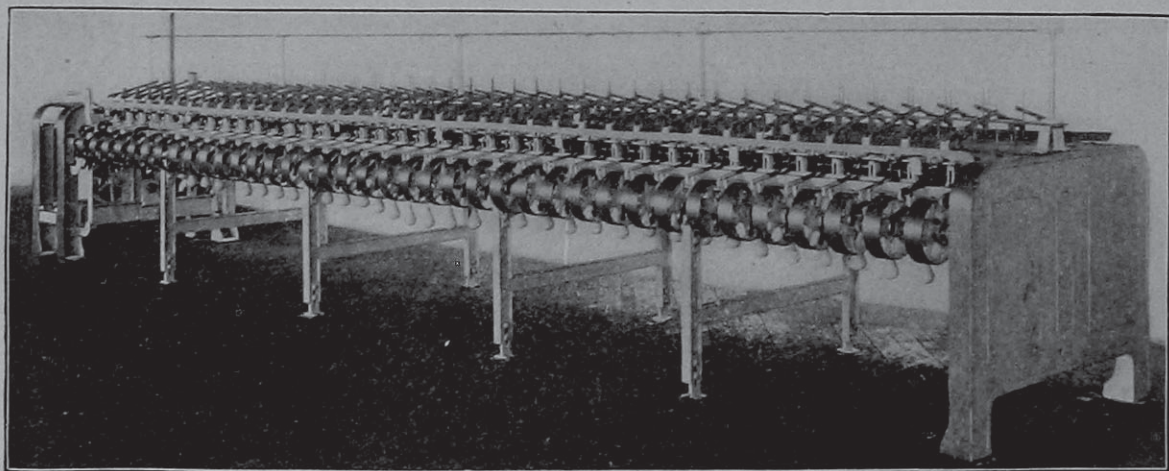

Woonsocket Machine & Press Company, **WOONSOCKET,**
Builders of Cotton and Woolen Machinery **R. I.**

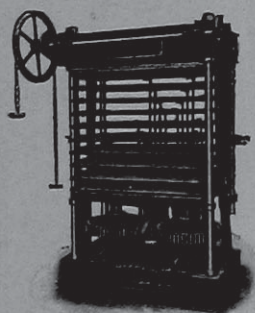

"HURRICANE" DRYERS

For Wool, Cotton Stock, Yarn, Knit Goods, Etc.

Belt-Driven **FANS** Motor-Driven

Power Screw **PRESSES** Hydraulic

WRITE FOR CATALOGUES

THE PHILADELPHIA DRYING MACHINERY CO.,
6721 GERMANTOWN AVE., PHILADELPHIA, PA.

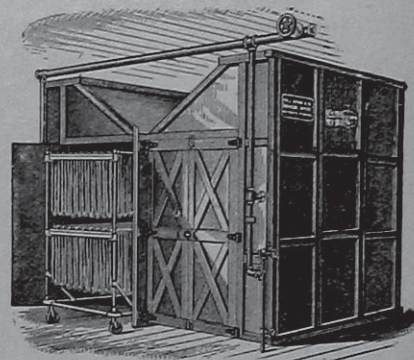

Boston.

Providence.

Philadelphia.

Chicago.

Charlotte.

Albany.

Toronto, Can.

FARBENFABRIKEN OF ELBERFELD CO.,

IMPORTERS OF ANILINE & ALIZARINE COLORS

P. O. Box 2162

NEW YORK

117 Hudson Street

New England Butt Co.

Providence, R. I.

Braiding Machinery, both American and German types, for making Dress Braids, Shoe and Corset Laces, Underwear, Trimmings, and all kinds of Round and Flat Braids.

NORTHEASTERN TRADING COMPANY

IMPORTERS AND DEALERS

Russian, China, Turkey, Iceland and Other Foreign
Wool, Hair, Mohair, Eiderdown and Skins

New York Office:
74-76 WALL STREET

114 Arch Street
PHILADELPHIA, PA.

Boston Office:
620 ATLANTIC AVE.

tional machinery. They are also building a brick cotton warehouse.

Zebulon, N. C. Archibald Meldrum and associates are organizing a company with capital stock of \$100,000 to build a cotton mill for the manufacture of hosiery yarns.

Anderson, S. C. The Orr, Cox and Brogon Cotton Mills, which closed down on August 1, have resumed operations.

Walhalla, S. C. The Oconee Knitting Mills has increased its capital stock from \$30,000 to \$50,000, and has begun the erection of an additional building which will provide space for from 90 to 100 new knitting machines, increasing the mill's equipment to about 180 machines.

Gaffney, S. C. It is reported that the Gaffney Manufacturing Company intends to add in the near future some 1,500 spindles to their plant.

Cedar Falls, N. C. The Cedar Falls Manufacturing Company have incorporated with a capital stock of \$50,000.

Marion, N. C. The incorporators of the Marion Knitting Mills Co., capitalized at \$100,000, will equip a plant for the manufacture of hosiery. The initial equipment will be 30 knitting machines, with the accompanying ribbers, loopers, etc., about 30 hands will find employment.

West Point, Ga. The West Point Manufacturing Co.'s new mill on the Chattahoochee River, known as the Shawmuth Mill, has been completed. The equipment will consist of about 35,000 spindles and complementary machinery for manufacturing duck and other heavy cotton fabrics.

Athens, Ga. The Southern Manufacturing Company is operating at full capacity day and night. The plant operates 20,000 spindles and 390 looms

on cotton flannels, and employs about five hundred persons.

Douglasville, Ga. The Lois Cotton Mills will begin operations about October 1. The mill will start with 10,000 spindles, to be increased at a very early date.

Griffin, Ga. The Rushton Cotton Mills, which were partially burned in April, have been put in working condition and are now running on schedule time. This mill makes fancy goods in the gray flannelettes, shirtings, etc., and employs about 300 hands.

Galesville, Ala. The Galesville Cotton Mills, which was organized recently, expects to begin the construction of its plant in about two weeks. An equipment of 3,500 spindles for manufacturing cotton yarns will be installed.

Tupelo, Miss. The Tupelo Cotton Mills have increased their capital stock to \$110,000.

“Textile Designing Simplified.”

The object of this chart is to show how easy weaves for all classes of Textile Fabrics can be constructed; it will be a search light in the misty matters in the field of designing Textile Fabrics. Keep this chart of weaves for reference. Millions of new weaves can be obtained by it.

All weaves for Textile Fabrics have their foundation in Plain Twills and Satins.

PLAIN.—This weave and its sub divisions are explained on the chart in the top row by 16 weaves, the sub-divisions covering common, fancy and figured Rib and Basket weaves.

TWILLS.—The foundation of constructing regular (45°) twills is shown by rows 2 and 3 with twenty six weaves, covering twill weaves all the way from 3 harness up to 13 harness. The sub divisions of twills are quoted next on the chart, being Broken twills, Skip twills, Corkscrews, Double twills, Drafting twills, Curved twills, Combination twills warp drafting, Combination twills filling drafting, 63° twills, 70° twills, Wide wale twills, Entwining twills, Checker-board twills, Pointed twills, Fancy twills, thus covering every sub division of twill weaves possible to be made.

SATINS are next shown, giving also their sub divisions, viz: Double satins and Granites.

HOW TO PUT A BACK FILLING ON SINGLE CLOTH is shown below the satins by two examples, and at its right hand is quoted the principle of

HOW TO PUT A BACK WARP ON SINGLE CLOTH.

On the bottom line are given the four steps for:—
THE CONSTRUCTION OF DOUBLE CLOTH, 2 @ 1; and above the same one example, with the arrangement 1 @ 1.

THREE PLY CLOTH is shown by one example.

HOW TO BACK SINGLE CLOTH WITH ITS OWN WARP is shown by two examples.

WEAVES FOR SPECIAL FABRICS are quoted: Tricots (warp, filling and Jersey effects), Rib fabrics, Honeycombs, Imitation Gauze, Velveteen, Corduroy, Chinchillas, Quilts, Plush, Double-plush, Tapestry, Grape, Terry, Worsted coating stitching, Huckes, and Bedford cords

HOW TO WORK THIS CHART OF WEAVES.

CAPITAL LETTERS of references refer to the plain weave and its sub-divisions.

SMALL LETTERS of references refer to twills and their sub-divisions.

NUMERALS of references refer to satins and their sub-divisions.

Example.—How to ascertain the construction of the weave at the right hand top corner of the chart; being the figured rib weave marked C C'? These two letters of reference mean that said figured rib weave is nothing else but the combination of the 2-harness 6 picks common rib weave warp effect C, and the 6 harness 2 picks common rib weave filling effect C'.

Example.—The letter of reference *e*, underneath the first broken twill indicates that the same is obtained from the 1/2 4 harness twill *e*, (third weave on the second row; in other words, letter of references below each weave of any of the various sub divisions refer always to the corresponding foundation weave.

Example.—Twill *q* and *o*, are the foundation for the eight combination twills filling drafting, said common twills are drafted 1 @ 1, the different designs being obtained by means of different starting.

Example.—The wide wale twill *l' w'*, has for its foundation the 63° twills, marked also respectively *l'* and *w'*, the latter two weaves have again for their foundation respectively the common twills marked *l* and *w*.

Example.—Granites marked 8 have for their foundation the 8-leaf satin, such as marked 12 the 12-leaf satin.

Example.—Backed by filling *e* 8, means the common 2/2 4-harness twill *e*, (fifth weave on second row) and the 8-leaf satin is used in the construction of this weave.

Example.—The complete design of double cloth, marked *e* 8 A, means that the common 2/2 4-harness twill (*e*), the common plain (A) and the 8-leaf satin (8) are used in the construction.

Example.—Rib fabric A, indicates that the plain weave forms the foundation. It will be easy to substitute different foundations in constructing weaves for heavy weights. In reference to single cloth weaves we only want to indicate that by following rules shown in the chart, millions of new weaves can be made up from it.

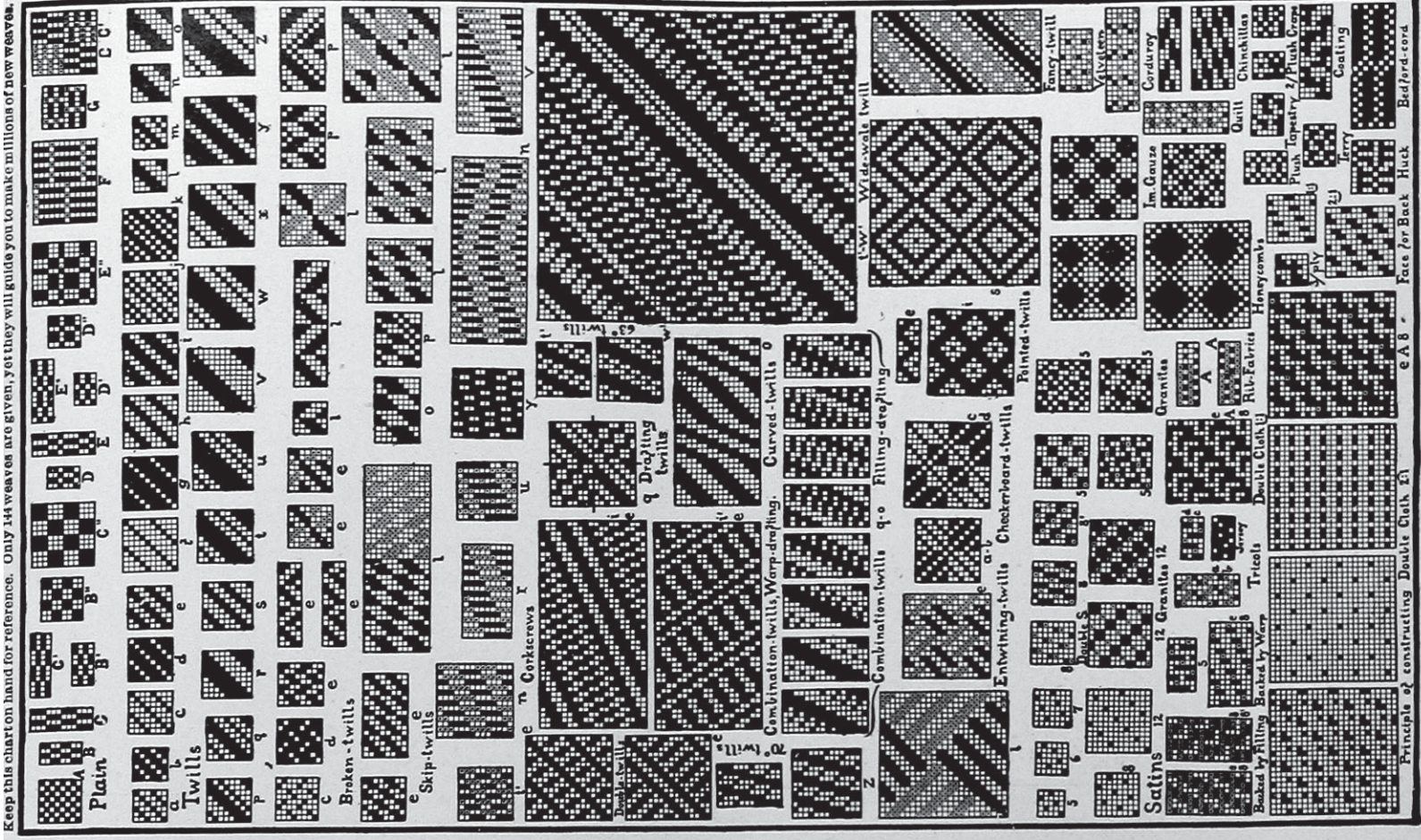

Keep this chart on hand for reference. Only 144 weaves are given, yet they will guide you to make millions of new weaves.

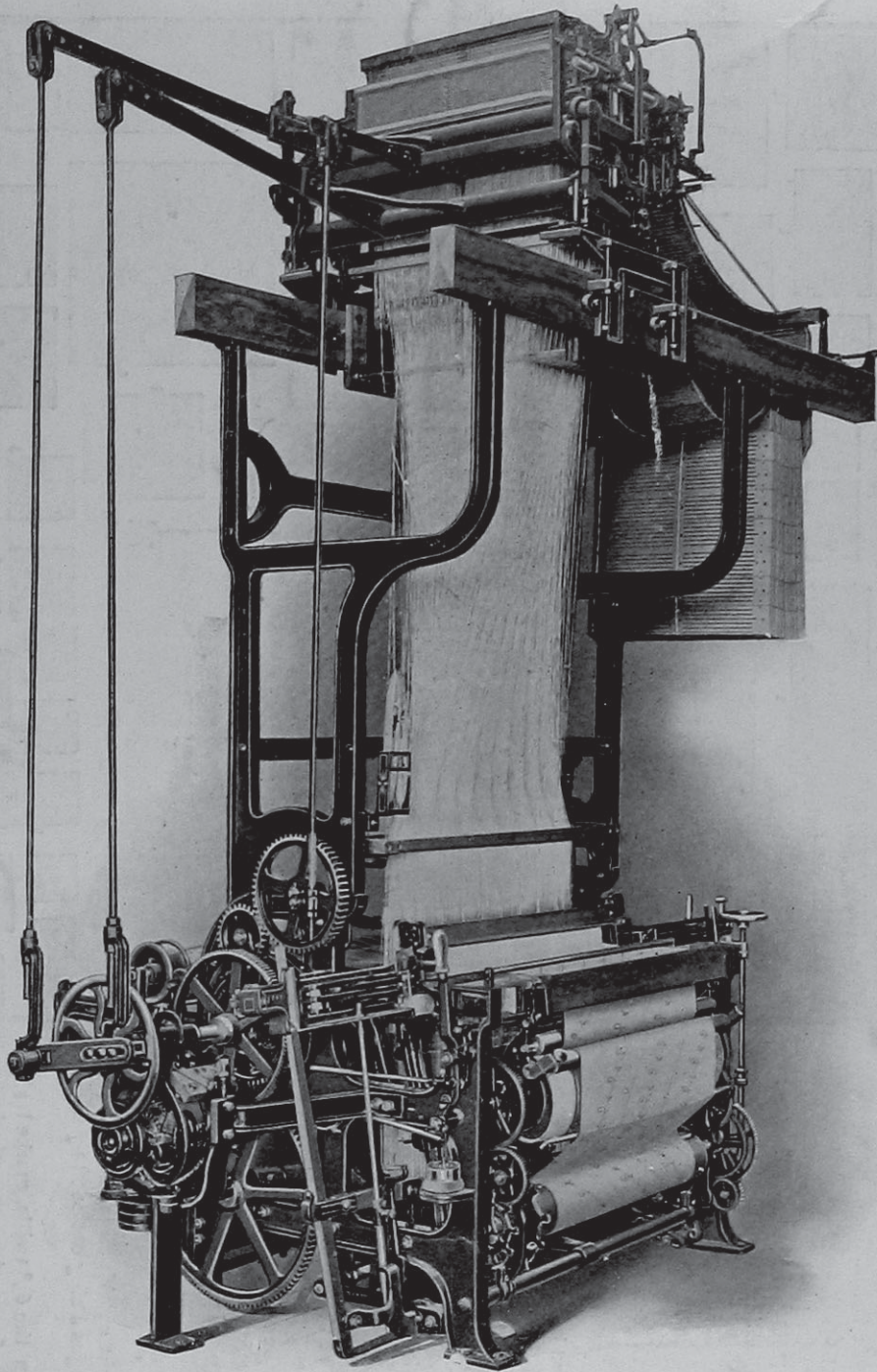

C. & K. JACQUARD SILK LOOM WITH MOTOR DRIVE

THE combined efforts of our experienced builders are directed toward a steady advancement year after year in all our varieties of weaving machinery. We want you to expect the best in every machine bearing our name.

CROMPTON & KNOWLES LOOM WORKS

WORCESTER

PROVIDENCE

PHILADELPHIA