

portion of the stocking, the needles 1, 2, a, 3, 4, b, 5 and 6 and 72, 71 a', 70, 69, b', 68 and 67, being those upon which the bordering wales (x in Fig. 1) in the shaped portion of the calf are produced, and the

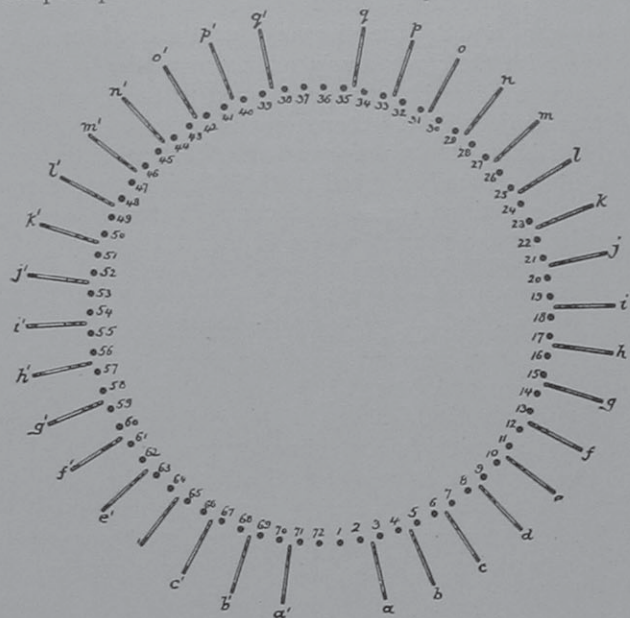

Fig. 3

needles 1, 2, 72 and 71, those upon which the bordering wales (x' in Fig. 1) in the gusseted portion of the foot are knitted.

HOW THE SHAPING OF THE HOSE IS DONE. Assuming that the leg portion of the stocking is being knitted of full diameter, the first narrowing operation for the shaping of the calf portion of the stocking is effected by transferring the stitches from the needles (only one side of the hose being quoted, the other side being a duplicate) in the following way: c to 6, 7 to c, 8 to 7, d, to 8, and so on, until needle q transfers its stitch to needle 34, whereupon said needle q is dropped. After the production of any desired number of courses of stitches, further narrowing is effected by transferring the stitches in the same way until needle p is reached, which needle is then dropped, and these operations are repeated, stitches transferred from each needle to its adjoining needle, and the needles o, n, m, l, k, j, h, g, f, e, d and c successively dropped, by which time the full narrowing operation has been completed, the doubling being always effected from the needle c onto the needle 6, so that the wales produced upon the needles 6, 5, b, 4, 3, a, 2 and 1 are never disturbed but produce the band x (see Fig. 1) of continuous parallel stitches.

Having narrowed the tubular web from a diameter available for the leg portion of the stocking to one available for the ankle portion, the knitting of said ankle tube proceeds until the heel is started by temporarily throwing out of action, but permitting to retain their stitches, the needles around one-half of the cylinder, say for instance, those from 19 to 54 inclusive, and then knitting to and fro upon the remaining needles from 18 to 1, and 72 to 55, and upon the dial needles a, b and a', b', first narrowing and then widening upon the end needles of the set, and then resuming the production of tubular web for the foot.

At this time, the formation of the instep gussets is effected by first transferring stitches from needle a to 2, 3 to a, 4 to 3, and b to 4, needle b then going out of action, while on the next narrowing the stitch is transferred from needle a to needle 2, and said needle a is put out of action.

The cylinder needles only are now in action, the tubular web is knitted upon the same for the production of the narrow foot, and after the completion of the latter a toe pocket is formed upon the needles 18 to 1 and 72 to 55, preparatory to beginning the formation of a new stocking upon all the needles.

Upon inquiry at the builders of the machine, we were informed by their manager, that a single specimen machine has been put into operation in their place and that the building of these machines, on a larger scale will be begun by them in the near future; combining then four heads into one machine.

Two New Lace Structures.
(Patented.)



French Welt Rib-top Machine.

The accompanying illustration is a view of a rib-top, turned out on the regular *French welt rib-top machine*, operated with two feeds. The same has an automatic slack course tucking attachment, casting off on one set of needles and starting the welt on both.

Same machine can be used for sleeves, with automatic change for half cardigan and full cardigan stitch.



A—Double French Welt.
B—Slack Course for Looping on Topping.
C—Cast off Course for Separation or Cutting.

The machine is built in any gauge up to 320 needles on a four inch dial, with 160 needles in dial and 160 in cylinder.

The illustration clearly shows the superior connection between 2 tops, only a portion of the lower top being shown in the illustration.

The knitted length of tops can be severed on any automatic rib-cutter.

The machine is being introduced in the market by Mr. Max Nydegger, of New York and Philadelphia, the prominent importer of knitting machinery.

THEORY OF WOOL DYEING.

The true explanation of the underlying principles involved in the dyeing of wool and other fibres has for a very long time been a subject of speculation and discussion, and by the discovery of the coal tar dyestuffs, with their previously unknown methods of application a great impetus was given to the discussion of this subject by the many leading chemists. Many theories have been put forward at different times, but it is now generally agreed that all dyeing phenomena can be explained by one or other of the following theories, or by a combination of them.

- (1) The Mechanical Theory.
- (2) The Chemical Theory.
- (3) The Theory of Solid Solution.

At the present time no single theory will explain every dyeing phenomena in a satisfactory manner.

The Mechanical Theory. This is the oldest theory and may be stated in the following terms:

The particles of the dyestuff penetrate the pores or spaces in the mass of the fibre, and as the fibre is more or less transparent, it becomes colored by the presence of the particles of dye. In other words, dyeing is simply due to absorption and is very similar to the sucking up of liquids by a sponge. It is, therefore, merely a physical property, and is, or is allied to a particular form of capillarity. In the light of our present knowledge it is difficult to give examples to illustrate this theory on wool, but perhaps the best example is found in the *tinting* or *bluing* of undyed fabrics which have a slight yellow color. When worked in a bath with finely ground Indigo, Ultramarine or other blue pigment, the cloth takes up enough of the pigment to optically neutralise the unpleasant yellow tint, and give a white appearance to the fabric.

On cotton, good examples would be the formation of mineral colors, such as Iron Buff, Chrome Yellow, etc., and also the fixation of Vat Indigo.

The Chemical Theory. According to this theory actual chemical combination occurs between the wool fibre and the dyestuff. The wool may be looked upon as a chemical reagent, which is capable of combining with, or precipitating, the dyestuff.

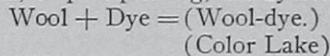

Wool contains, or is capable of producing, a body known as Lanuginic Acid; a name which is rather unfortunate, because not only has this body acid properties, but it also possesses well marked basic functions. Lanuginic Acid is a very complex body, and it contains amino (NH_2) groups which are basic in character, and are therefore capable of combination with color-acids (acid dyes); it also contains carboxyl (COOH) groups, and these being of an acid character, are capable of combination with color-bases (basic dyes). If Lanuginic Acid is dyed with acid colors which have no basic characters, as for instance many of the azo colors, combination only occurs at the amino group, and the carboxyl group is left unsatisfied.

As many of the sulphonated basic dyes have basic

characters, as well as the acid properties imposed upon them by the sulpho groups, they are capable of combining with both the amino and carboxyl groups at the same time.

The following diagram will explain this more clearly.

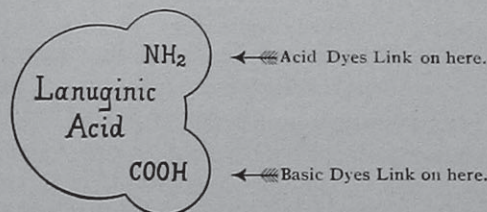

Dyeing with acid or basic colors may thus be said to consist in the formation of chemical precipitates, or color lakes.

What explanation can be given of the dyeing properties of mordant dyes, such as Logwood and the Alizarin colors?

This also may be said to consist in the formation of color lakes, but with this class of dye, a third substance in addition to dyestuff and fibre is necessarily introduced, this third body the mordant is of such a character that it will chemically combine both with fibre and dyestuff, forming a triple compound of Wool-Mordant-Dye.

The simple Wool-Dye compound is usually not capable of existing, and even when it can be formed it does not possess a useful color. Another essential of the mordant is therefore that the compound which it forms with the dye must possess satisfactory coloring power.

The mordanting is simply another illustration of the previously explained union between the carboxyl groups in the wool and the base. The mordants as fixed on the wool are generally metallic oxides or hydrates and thus it is the carboxyl group with which they will combine.

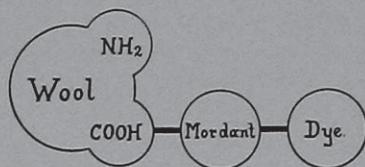

As the metallic oxides are very insoluble in water and in alkaline liquids such as soap solution it can easily be understood why mordant dyes are so fast to washing, soaping and fulling; properties which most acid dyes do not possess because the color-acid combines with alkali to reform the soluble color-salt which promptly bleeds out of the wool.

When dyeing with basic dyes such as Magenta a peculiar reaction takes place. Magenta is the chloride of Rosaniline base. If wool is dyed with this compound the Rosaniline base combines with the carboxyl groups in the wool and the hydrochloric acid remains in the solution, but not in the free state. When wool is boiled in water a certain amount of ammonia is evolved. The free hydrochloric acid combines with the ammonia liberated from the wool and forms ammonium chloride in which state it is found in the waste

dye liquor. If a colorless solution of Rosaniline base is prepared and some wool is dyed in it, the wool gradually becomes colored owing to the combination of the Rosaniline base with the carboxyl group in the wool, forming a color lake or salt; and as only salts of Rosaniline are colored, this is one of the proofs that wool has acid characters. Dissociation may also play an important part in dyeing processes.

The Theory of Solid Solution. This theory was put forward in 1891 by O. N. Witt and was based on Van t'Hoff's solid solution theory of the previous year. It partakes partly of the chemical and partly of the mechanical theories, and may be stated in Witt's own words. "A dyestuff must be intensely colored, so that it can communicate its own shade to colorless substances holding it in solution. It is soluble in water, etc., and much more soluble in the colloid forming the substance of the fibre. It is a case of solid solution. Secondary chemical influences occur, such as that of the mordants, changing the solution into a suspension, by precipitating the dyestuff after its immigration into the fibre."

As an example of a solid solution take the case of gelatine, which, unlike the fibres has no structure, but will dye. The dyestuff is therefore more soluble in the gelatine than in water.

Magenta dyes wool in aqueous solution. If the dyed wool is put into alcohol the color bleeds off.

The color is more soluble in wool than in water and is more soluble in alcohol than in wool. It is therefore a theory which involves the relative solubility of the coloring matter in water and in the fibre and it affords a good explanation of the fact that many dyestuffs do not exhaust in the dyebath.

The properties of that group of dye known as Direct Cotton Colors can be very well explained by the solid solution theory, as the dyestuff enters or dyes the fibre in the form of the soda salt.

Although outside the strict limits of the subject, viz:—Wool dyeing—it may be as well to state that Weber considers that the phenomena observed when cellulose is dyed with direct cotton colors and which Witt asserts to be a solid solution of the dye in the cellulose, is simply diffusion, and when the dyebath contains the salts which are usually added in the dyeing operation a higher osmotic pressure of the dissolved dye is produced, causing the dye to pass into the cotton more readily.

Some Objections to this Theory. In the experiment with Magenta, described before, according to Knecht, the color removed in the alcohol bath is not Rosaniline base, because that body is colorless, nor is it the chloride, as the hydrochloric acid was removed in the aqueous dyebath, but it is a lake of Magenta, produced by the combination of the Rosaniline base with some constituent of the wool which is not lanuginic acid, as it does not give a precipitate with acid dyes. This tends to support the chemical theory because, as Weber says, "Witt's theory assumes the colors are in the free state in the fibre, as soon as any interaction is set up, the hypothesis becomes superfluous." (W. M. Gardner and A. B. Knaggs in "Wool Dyeing.")

NEW COLORS.

(Farbenfabriken of Elberfeld Co.)

Gallo Viridine G: A new mordant color; a very easily soluble powder which produces in conjunction with acetate of chrome, bright green tones of a good fastness to soap and light. On account of its bright shade, it is adapted for the printing of upholstery cloth and fast color dress material.

Sericose L: is of great interest for the production of matt printing effects (damask effects) on textile fabrics, especially on cotton. It also fixes basic colors used along with it and it is therefore possible to dye the mat effects in any desired shade by adding the dyestuff, dissolved in a little acetic acid, with or without the aid of tannic acid. Pretty effects can be produced by printing with the aid of blanc-fixe, etc., on a dyed bottom.

Victoria Navy Blue L: dyes level very easily and is therefore very well adapted for the production of bloomy navy blues on ladies' dress material and cheap suitings for boys' wear. White cotton Checking threads remain perfectly pure. As the fastness to washing alongside white wool is sufficient for ordinary requirements, the color may also be employed for the dyeing of different yarns. It is also adapted for direct printing on wool.

Acid Anthracene Red 5 B L: A very serviceable substitute for Cochineal for the dyeing of loose wool, slubbing and yarns employed for checking threads fast to washing, selvedges, fancy color dress and blouse material, etc. The product is furthermore of value for flannels to be dyed in the piece for which a better fastness to washing is required than for those Reds produced with the ordinary Ponceau brands. Apart from the dyeing of wool, the color is also adapted for the dyeing of silk and silk-unions (wool-silk); both fibres being dyed almost the same shade. It is also very well adapted for direct printing of wool.

Brome Indigo F. B. (in Paste): For dyeing cotton, linen, wool and silk shades of excellent fastness. It is remarkable for its clear bright tone compared with Indigo, and for its good vat dyeing and excellent dyeing properties, which render it possible to dye piece goods on the jig in the ordinary way, without any trouble with regard to broncy selvedges. It can also be successfully padded on the mangle. In order to produce dark shades, it is not necessary to give several dips, the strength of the bath being increased; the dye liquors exhaust fairly well. It is also adapted for the dyeing of loose material and yarns which are employed for the fancy woven articles, bed-tickings, aprons, etc. Loose material and yarn can be dyed in dyebecks, or other suitable apparatus. It also yields very good results in calico printing.

Benzo Scarlet B C: A new red Benzo color which produces very bright reds on cotton as well as on wool, half wool and silk. It dyes very easily level on cotton and the shades are of a good fastness to acetic acid and alkalis. It is also suitable as a combination color for the dyeing of all cotton fabrics. In connection with wool, it is very serviceable on account of its brightness and good fastness to washing and fulling

alongside white wool and also on account of its fastness to stoving and light. If used for dyeing half-silks, a brighter and yellower shade is produced on the silk than on the cotton. On silk, reds of a fairly good fastness to water are obtained.

FULLING.**The Process and Modern Machinery.**

(Continued from page 95.)

When planning a new fabric structure, the designer or the superintendent of the mill, as the case may be, has to calculate for two weights of the fabric in question, viz: (a) the weight of the fabric from loom, and (b) its finished weight.

As a rule, the first will be heavier than the latter weight referred to, with the exception of cheap, extra heavily flocked goods, made in plain and fancy colors, and where the finished weight of the fabric depends considerably upon the amount of flocks, *i. e.*, weight that was added to the fabric during fulling.

We will now consider the bulk of our woolen and worsted goods made, *i. e.*, those which come heavier from the loom than when finished, and inquire into the reason where this loss in weight during the finishing process occurs, considering the affair first in connection with woolen goods and afterwards with worsteds. Experience is the only guide for the superintendent in his labors.

The first loss to consider is the loss of grease, dirt and other foreign matter, removed from the goods during the fulling and scouring process. The wool as coming from the sheep's back had been thoroughly scoured and then put in an absolute clean condition, in which, however, it could not be handled in the card room nor the spinning room *i. e.*, it must be *conditioned* by means of adding a lubricant to said clean wool, when picking and mixing a lot of wool for the card room. This lubricant (with the exception of its water and which certainly evaporates during spinning) remains in the yarn and goods as coming from the loom, and is included in the weight of the count of yarn as well as weight of fabric per yard from loom. It is loosened, *i. e.*, liberated from the yarn during fulling and must be removed completely during scouring (clean goods are always desired) hence is one of the items accounting for a loss between loom and finished weight. If the warp has been sized during the dressing of the latter, such size has to be loosened during fulling, and naturally is a loss to be taken into consideration, between the weight of the fabric from the loom and its finished weight. At the same time, if dealing with colored yarns any refuse of dyestuffs adhering to the yarns must then be removed. This may little, if any, influence some of our bright colors, but with dark colors will be an item to be considered. Now in addition to this loss of grease, dirt, dyestuff refuse, etc., there is some loss by wear of the process, known as fulling flocks—shorter fibres possibly not fully incorporated with the threads, and which pulled out from the thread, *i. e.*, liberated themselves during the fulling. Examining

any fulling mill during running, or after a piece is taken out, will reveal any amount of stock—short fibres—intermixed with soap and gathered all over the inside of the fulling mill, more particularly at projections and the bottom of the mill. Again, some of these fibres may adhere to the cloth, being finally liberated from it during the scouring or washing process, in connection with soap, loosened grease, dirt, etc. All means a loss in weight, and must be taken into consideration by the superintendent, when planning the lay out for fabrics.

A second loss in weight to the fabric occurs during gigning or napping (provided the fabric is subjected to these processes) and when short fibres which cannot stand the strain of opening the felt of the fabric, as produced by the fulling process, are removed as gig or napper flocks from the fabric.

A third loss in weight occurs during the shearing and brushing processes, depending upon the amount of shearing and brushing the fabric requires. Shear flocks is the name given to this loss, *i. e.*, clippings of fibres.

As will be readily understood there is a loss of fibre in any other process or machine the fabric passes through, however, such loss is what we may consider *nil*; the three items referred to being the chief source of loss.

As will be readily understood, this loss in weight in the finishing varies with different fabrics, where one may lose 25%, others only may lose 10%, or less.

Worsteded have thus far not been taken into consideration, in an average taken, they will lose little and in fact a light colored, bright worsted dress goods, requiring only a most careful scouring and clipping on shear, may lose hardly anything. Again, a coarse worsted, black, brown or dark blue cheviot, dealing with a fibre requiring lubricating so as to be able to handle it during the spinning processes—the fabric requiring also some fulling, will come nearer to percentage lost by similar woolen goods, only that there will be less flocks during the fulling process, the fibres being longer and on this account as well as the process of combing, more closely united into the thread.

Again, in connection with a great many woolen fabrics, a slight amount of flocking is always practised and which to a certain extent counteracts its loss, for reason previously quoted. Judiciously flocking certain fabrics shall not be considered as a detriment, it is one of the processes keen competition commands and in the hands of a careful and experienced finisher will not be readily (if at all) noticed.

Calculations. We will now explain how to figure for this loss with a few practical examples.

Example: Ascertain length of fabric to shrink, if Loom weight is 20 oz.

Finished Weight required 16 oz., and

Loss in fulling, scouring, gigning, brushing, shearing, etc. 20%.

100% fabric structure from loom

20% fabric structure lost

80% fabric structure left.

Thus 20 (loom weight) \times 0.80 (fabric structure left) = 16 oz. \times 36 (inches in one yard) = 576 \div 16 (finished weight) = 36 inches, and 36 minus 36 = 0.

Answer: No shrinkage in length is required.

The affair can also be expressed as a

Rule: Multiply loom weight with per cent. of fabric structure left and the inches in one yard and divide product by finished weight and subtract result from inches in one yard, the quotient being the number of yards the fabric has to be shrunk to bring the finished fabric down to weight required.

Example: Ascertain length of fabric to shrink if Loom Weight is 26 oz.

Length of fabric from loom 48 yards

Finished weight desired 23 oz.

Loss in finishing process 18%

100 less 18 = 82 and

$26 \times 0.82 \times 36 \div 23 = 33.37$ inches, and

36 minus 33.37 = 2.63 inches, or practically $2\frac{3}{4}$ inches is the amount each yard of fabric has to be shrunk; or if considering length of fabric from loom, expressed in yards, to length of fabric requiring from fulling mill, *i. e.*, after shrinking the fabric, and figuring by proportion, taking shrinkage per inch, as previously obtained for our basis, we find:

$48 : x :: 36 : 33.37$ and

$48 \times 33.37 \div 36 = 44.49$ or

Answer: The 48 yards of length from loom must be shrunk to $44\frac{1}{2}$ yards, in order to obtain finished weight (23 oz.) desired.

TAKING FLOCKS INTO CONSIDERATION. By means of previous examples, a guide has been given to calculate any example we may come in contact with where no flocking is done. Wherever flocks are used, considered in an average, only about one-half of the flocks put in the mill will felt on sufficiently to adhere to the fabric, hence double amount figured. At the same time it must be remembered that flocks vary in their quality considerably, again, that a light flocking will be in favor of the one-half, since the first flocks will go on readily, whereas if we have to flock extra heavy, the flocks are not taken up so easily; again, the nature of the fabric to be flocked during fulling has considerable to do with the taking up of flocks. For instance, all wool loosely interlaced overcoatings, constructed of a soft twisted filling, by permitting the flocks readily to work themselves into the structure, will take up flocks easier than, for example tightly woven coarse wool chevots, or a union cassimere, whether constructed with a cotton warp and a wool and shoddy mix filling (satinets) or containing wool shoddy and cotton in mix, both in warp and filling.

Example: Weight of fabric from loom 32 oz. Finished weight required 28 oz. Loss in finishing (scouring, gigning, shearing, etc.) 25%. Shrinkage in length 5%.

(1) Ascertain amount of flocks to be added per yard.

(2) Ascertain amount of flocks to be added, the fabric from loom to measure 45 yards.

(1) $32 \times 100 = 3200 \div 95 = 33.68$ oz. weight of stock per yard in fabric, considering shrinkage in length only.

$100 - 25\% \text{ loss} = 75$, and

$33.68 \times 75 = 2526 \div 100 = 25.26$ oz. weight of stock per yard in fabric, considering shrinkage in length as well as loss (25%) in finishing.

28.50 oz. weight of fabric required

—25.26 oz. weight of stock

2.74 oz. difference (per yard) and which have to be made up by flocks. *Answer* (1).

Practically, add about ($2\frac{3}{4} \times 2 =$) $5\frac{1}{2}$ oz. flocks per yard.

(2) 45 yards length of fabric from loom.

Shrinkage during fulling 5%

$100 : 95 :: 45 : x = 42.75$ length of fabric after fulling, and

$42.75 \times 2.74 = 117.125$ oz.

$117.125 \div 16$ (oz. = 1 lb) = 7.32 lbs. of flocks must stay on this piece of cloth to bring it up to weight required. *Answer* (2).

Use about ($7.32 \times 2 = 14.64$) 15 lbs. of flocks in the mill, based upon item that only half the amount of flocks will stay on the fabric.

TO CALCULATE WEIGHT OF FINISHED FABRIC, IF LOOM WEIGHT, LOSS IN WEIGHT AND LENGTH ARE GIVEN.

Example: Loom weight 18 oz.

Loss in finishing process 15%

Shrinkage in length 3%

Ascertain weight of finished fabric

$18 \times 100 = 1800 \div 97 = 18.55$

$18.55 \times 85 = 1576.75$

$1576.75 \div 100 = 15.76$ oz., or practically $15\frac{3}{4}$ oz. weight of finished fabric. *Answer.*

There will be cases met with where an extra inch or more of shrinkage per yard has to be allowed, in order to balance any stretching the fabric is subjected to when passing through the after processes of the finishing. Such can be readily ascertained by testing one piece through the various processes and ascertain by actual measuring the amount of stretch imparted to the fabric from the time it left the fulling mill until measured for the market. As will be readily understood, to give satisfaction to the manufacturer, the fuller must have experience, since it requires judgment and experience on his part to shrink a piece the proper proportions, either widthways or lengthways, in order to bring the fabric up to the required weight, width and length. This will explain to us that the fuller has to take the fabric occasionally from the mill and measure it in length as well as width and see to it that it fulls evenly. Possibly he may have to add some weight, again, he

may have to add soap, in order to keep the fabric in a perfect condition for fulling. A practical, efficient fuller will be guided a great deal in his work by the feel of the goods under operation, experts in their line being able to tell by this feel the condition of the fabric to a nicety, without having to retard the process of fulling by excessive examination of the fabric. Pulling the fabric out from the fulling mill and thus cooling it, will retard the process of fulling. As will be readily understood, off and on he will have to examine the fabric, but he will not have to overdo it, in order to obtain satisfactory results.

The Kicker Fulling Mill. Although these machines have been, as we might say, very largely superseded by the modern rotary fulling mill, yet at the same time, for results as to quality of felt produced, no modern fulling mill can equal it. This mill is a modern adaptation of the olden time Falling Stock. It is especially adapted to tweeds with wool warps and worsted filling, cotton warps with wool filling, cheviots and bannock burns; all twist goods requiring little fulling, in fact any class of goods will be benefited by a partial fulling in the kicker mill. By its use, mill wrinkles are avoided, felting is firmer, goods are left in a better condition for finishing, colors are brighter and a soft, mellow handle is obtained. The fabric in these fulling mills lays in a semi-circular trough, the action of the heavy feet of the machine coming forcibly against it, being the cause of the felting of the cloth. The peculiar shape of both, the trough and the feet, causes the cloth to constantly turn during the process, in turn producing uniform work. An advantage of this method of fulling over that in the rotary mill is the fact that the whole piece is fulling at once, while in the latter machine the fulling is intermittent, the cloth fulling only as it passes through the rolls and the crimping box. The soft cushion effect produced by the cloth being in bulk, in the kicker mill, is certainly conducive to good results to fabrics fulled in these mills. A disadvantage to these mills for all around work is the fact that it is impossible to stop the cloth from fulling lengthways, *i. e.*, impossible to regulate shrinkage of cloth in length, vice versa its width, except by its construction; it is bound to full in length during the process, the amount depending upon the amount of twist in warp and the nature of the weave used. Not being able to regulate to a nicety the shrinkage of the fabric between its length and width is certainly, with the bulk of our present day goods and process of manufacture, a drawback to the more liberal use of this machine in woolen mills; however, these kicker mills are used in many instances, at the present day, in connection with the rotary mills, to secure the best results on goods requiring a peculiarly firm and heavy felt. The fulling with these kicker mills is considerably slower than that with the rotary mill, and it is likely that the first introduction of the latter had for its object to save time, and when improvements made since then have resulted in a machine by which the cloth may be made to gain over the woven length, or to shrink almost any desired percentage.

Fig. 3 is a section lengthways through this Kicker Mill as built by the James Hunter Machine Company, being given to show its working parts, and of which *A* is the trough in which the cloth to be fulled is deposited. *B* is the cover for said trough and which is lifted up and folded back, resting against

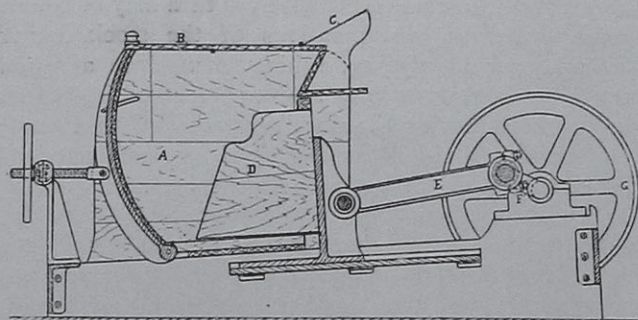

FIG. 3. SECTION OF "HUNTER" KICKER FULLING MILL.

support *C* when the cloth is placed in the trough, after which the cover is placed in position back on the trough, as shown in illustration. *D* is the foot of the kicker and to which a to and fro motion is imparted by means of piston *E* and crank *F*. *G* is the driving wheel.

It will be noticed that the shape of the trough and the foot of the kicker is such that the cloth will work itself around in the trough, *i. e.*, continually changing position, being turned over and over in the trough, so that the foot every time hits different portions of the fabric. The cover *B* is replaced on the trough in order to retain the heat in the latter. If heat gets too high, the lid can be either folded partly back or entirely back, as the case may require.

Mechanically Severing the Warp Floating Threads on the Back of the Fabric.

There are two ways of producing local effects on fabrics, by throwing in extra yarn to form figures or spots. Firstly, the figures may be produced by extra warp threads, and secondly, by extra filling.

In the latter case it is more expensive to produce the goods, because it requires the extra time to throw across the extra filling, the necessary slower speed of a box loom to that of a single shuttle loom, besides the range of colors is limited, since each separated color requires a separate shuttle.

After the goods, of either construction, come from the loom, in order to produce a clear and distinct effect, *i. e.*, that the floating ends do not show through on the face (the fabric in question being as a rule of a rather thin, hence more or less transparent texture) it is necessary to cut away the loose floating threads between the local designs or spots.

In the case of the filling produced designs, it is only necessary to pass the goods through a shearing machine, as the strain on the warp threads throws up the filling floating threads clear off the surface of the fabric and allows them to be caught in the spiral knives of the shear and be cut away.

In the case of warp-produced designs, however, the strain to the warp draws the floating threads close on to the surface of the piece, necessitating their being cut between the designs, *i. e.*, places of interlacing on the face of the fabric, before passing through the shearing machine to enable the loose ends to catch in the spiral cutter and be sheared away.

In looking at the problem, the first thing that appeals to one is the large range to which a machine would require to adapt itself to do the almost indefinite variety of cloths that might come its way, since the lengths of the floating threads between the designs, and the manner in which these designs are placed on the surface of the piece, and the shapes of these designs may vary indefinitely.

Another difficulty is the tendency to pull out the floating threads instead of severing the same, for instance, in the case of a diamond pattern, at the corner of the diamond, it will probably occur that a single warp thread has only one dip into the fabric, which means that it has practically no force or fixity in the fabric to resist its being pulled out of the fabric without being cut.

The attempts in the past to do this severing of warp floating ends on the back of the fabric, by machinery have mostly been by an arrangement of knives which pick up the floating threads and shear them, these knives having a to-and-fro motion across the surface of the fabric. The fabric is stationary, the knives cross cutting one set of floating warp threads and come back again to their original position when the fabric travels forward the distance of a design and the knives again cross the fabric and so on. By this principle, it is necessary to adjust the intermittent travel of the cloth to suit the length of the floating threads.

Another great difficulty has been the keeping of a sharp edge on the cutting knives to prevent those threads which are only very loosely fastened into the body of the fabric, from being withdrawn instead of severed.

In the new machine for this work, the invention of Mr. C. W. Fulton, these difficulties seem to have been eliminated, the only adjustment that is required being the speed of the cloth which runs continuously. The knives travel continuously at a fixed high speed, and at each revolution of the knives, they pass through an automatic sharpener. The pieces are sewn end to end so that the process is continuous and the sharpening automatic. When the length of floating threads between the designs is small, the cloth goes slower, and as they increase in length, the speed of cloth may be increased, but in both cases the speed of travel of the knives is the same.

The cutters for ripping or cutting the loops of the spot threads consist of a series of knives, carried by a continuously moving chain, by which the blades are moved across the fabric as it passes through the machine. The severing blades are so shaped and the fabric is presented to them in such a manner that the point of the blade passes between the floating warp

threads and the body of the fabric, and severs the threads.

The band carrying the severing blades is endless and is mounted on two drums or around two sprocket wheels mounted on vertical shafts or spindles arranged at opposite sides of the machine, and one or both of which may be driven by appropriate gear.

Nipping rollers are provided by which the fabric is thus kept taut and prevented from sagging during its passage through the machine.

Conveniently, a sharpening device is provided for the severing blades so that the tendency which might arise owing to bluntness to drag the parts of the spot threads woven in the fabric, will be avoided, and the necessity of stopping the machine frequently to renew or sharpen the cutters, obviated.

After the floats are severed, or opened, the loose threads may be beaten up by beaters so that they stand away from the body of the fabric and are in a more convenient position to be finally removed by a cropping shear. It is claimed that one of the new machines will handle from 3000 to 5000 yards of goods per day, and is adaptable to any size of design down to $\frac{5}{8}$ inch between spots. The agents for the sale of this machine in this country are Messrs. Knowles & Wollaston, 50 Church Street, New York.

PRACTICAL POINTS ON THE SHEAR AND THE SHEARING OF WOOLEN AND WORSTED GOODS.

(Continued from page 256, Vol. II.)

It will be noticed that fabrics containing a considerable percentage of cotton in their construction will shear harder than such as contain no cotton, although the latter will have a heavier nap, still it will be cut easier than such as composed of part cotton; for this reason, the cutting blades, *i. e.*, fly blades of the revolver must be in good condition to cut a cotton and wool mix nap.

Sometimes the fly blades will cut the cotton and wool mix nap at some points better than at others, in turn causing stripes to be seen on the inspecting table, a feature showing us that either the blades which done the work have not been in the best possible condition, or that some change in the setting should have been made.

The material used and the condition of the cloth to be sheared, plays a most prominent part with reference to the final result obtained by shearing. The quality of the stock used in the construction of the fabric, its state of cleanliness and degree of dryness are certainly items of importance to the success of the shearing process, the latter thus not alone depending upon the sharpness and setting of the fly blades and ledger blade as some might think. You cannot help but notice the difference in the sound of a shear when handling goods, each made from a different kind of stock, that is provided the fly blades (the revolver) are not set too close, since then the rattle of the parts of the shear will drown the actual cropping noise. The resistance which the brushed-up nap offers to the shear blades will be found to vary with the quality of

the material the nap of the fabric, is composed of. Not only will fibres of different breeds of sheep vary in this respect, on account of the difference (diameter) of the staple, but at the same time it will be found that wools of the same grade may sometimes offer a varying resistance to the fly blades. This difference in shearing, due to difference in the fibres, in turn may be helped along by wrong manipulations of the stock, either during scouring, dyeing, fulling, etc., since a sound wool fibre is more able to resist, *i. e.*, stand up before the fly blades during the shearing process than a staple less sound. Wool fibres not dyed, or such as dyed bright colors, or indigo, will offer more resistance to the fly blades than fibres which have been boiled for hours during dyeing them a dark brown, black, etc. Dead, limp fibres, as compared to sound fibres possessing elasticity, will also bend over before the fly blades, and consequently be either missed by the latter, or at the best, cut only imperfectly. This will explain why fabrics made from a limp, dead stock, will shear with less satisfaction as to final results, compared to fabrics in the construction of which a sound fibre was used. The process of steam lustering the cloth also exerts its influence upon the fibre, which by means of it, according to the amount of steaming done, loses a part of its elasticity, for which reason, a fabric treated in this manner will work differently in the shearing process from one not steam lustered. A steam lustered cloth, it will be found, is not as easily sheared as one not treated that way, the tight winding up of the cloth upon the steaming rolls or cylinders, according to whether a steam-gig or a steam-lustering machine had been used, pressing the nap down, and which by the process becomes fixed in this position, the fibres thereafter, no matter how much brushed up, always trying to resume their former position, the steam lustering at the same time reducing the amount of resistance of the fibres towards the fly blades of the revolver, during the shearing process. This will explain that the kind of stock used, condition (cleanliness and dryness) of the fibre, amount of steaming done, etc., all should be carefully considered, the shear-tender in turn employing the proper means to counteract their influence, and when for example, for a fabric constructed from a soft, flabby, material, he then must have his fly blades very sharp, the latter touching the nap as far forward upon the edge of the ledger blade as possible.

To permit the shear to do its work well, the superintendent of the mills must see to it that the wool has been properly scoured, and the finisher that the fabric has been properly scoured after the fulling process, since it is impossible to produce a smooth and satisfactory finish upon fabrics not perfectly clean. Such residues as yolk, oil, soap, etc., adhering to the fibres, will make them soft and spongy, and in turn impair their power of resistance before the fly blades, tending also to dull the latter, and in extreme cases prevent them from working properly, the revolver then throwing out an entangled, flacky mass, in place of our regular short flocks. Considered in its proper sense, the condition of the shearing flocks, can be considered as a fairly good sign with reference to the degree of cleanliness of the

fabric. The degree of dryness of the cloth is another item which influences shearing considerably, wet or damp cloth having characteristics which differ from

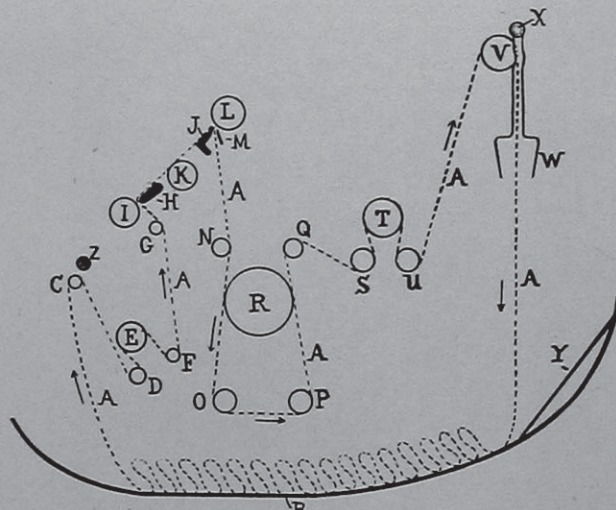

FIG. 1.

those of dry cloth, moisture to a certain degree softening the fibres which then become more yielding, and in consequence of which their power or resistance to the fly blades diminishes, for which reason, cloth which is to be sheared must be perfectly dry.

Slack Selvedges. Another chance for trouble to the shear-tender may come up in connection with goods heavily flocked, or such as fulled considerable in length with a slack selvedge and when the centre of the fabric will shrink most. In the first case, it may be hard to get a clear face whereas in the second case, real trouble for the shear-tender may be in store, since the edges of such a fabric then will shear clear, whereas its middle portion will require more work. To endeavor to shear the centre more without any change in program will surely weaken or cut the sides. To overcome the difficulty to some extent, put on a good tension on the cloth, what will draw the slack or thin edges down close to the rest, and allow the blades to drop, so as to shear the centre of the fabric somewhat closer. This may do with one or two pieces thus met with, but if referring to any number of goods, be sure that the superintendent, either looks after the construction of said fabrics, or the finisher looks after the flocking and fulling process and sees if trouble rests there, and if so, in turn prevents any reoccurrence. Never try and adjust the shear to such imperfectly constructed fabrics, by means of grinding or filling the rest, since the fault rests with the fabrics and not the shear.

Oiling, etc. Be sure to keep all running parts of the shear well oiled, and especially the revolver bearings, for if they begin to wear, it will be impossible to make the blades do good service. The revolver in connection with the steel rest shear turns at from 1000 to 1200 r. p. m., and the one of the rubber rest shear from 1200 to 1500 r. p. m., a feature which on account of this high speed will at once convince us, that by neglect of proper oiling, said bearings of the revolver are apt

to get dry, and when in turn they soon may get ruined. Clean the revolver at least once a week thoroughly and do not allow flocks to accumulate on the machine more than one day without cleaning. Many of the other places in the machine which need oiling, are situated where they are not readily visible, and hence are sometimes overlooked by carelessness on the part of the shear-tender. Amongst such places are the draft break roll E (Figs. 1 and 2) situated under the brush rest H, and which roll turns and therefore needs lubricating. The two application rolls O, P which serve as contact rolls for the laying brush R are also out of the way, and easily omitted by the operator, but they need oil just as regularly as the more prominently located moving pieces. So do also the two wood rolls, set beneath the brush pan and which serve to keep the cloth from rubbing against this pan, need oiling at intervals. These several rolls do not always squeak when they need oil and it sometimes happens that the arbors wear off completely before it occurs to the shear-tender that oil is required on them. Oiling up a machine is certainly a very simple process, but after all, it must be done right and not one place slighted. Again, oil must not be poured on until it can be seen running off on the frame work of the machine, since one or two drops may be all that was required.

The raising brush I in Figs. 1 and 2, should be taken out sometimes and reversed, which can be done by

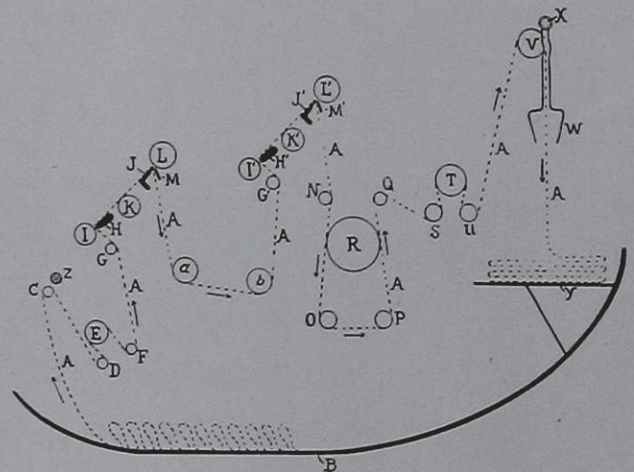

FIG. 2.

changing the pulleys from one end to the other, and when said brush will do better and more even work, and besides last much longer.

DESIGN PAPER

FOR WEAVING AND KNIT GOODS MILLS

In all Sizes at Manufacturers' Prices

For the special convenience of mills, we prepared 8 x 8 paper in tablet form, 5 by 8 inches printed surface, the pad containing 8 sheets ruled to 1/2 inch square and 32 sheets ruled to 1 inch square, 40 sheets in all. Price 15 ¢ a pad, or \$1.50 a dozen, postage prepaid.

TEXTILE PUBLISHING COMPANY

Lambert and Berks Streets

Philadelphia, Pa.

DICTIONARY OF WEAVES.

TWELVE HARNESS

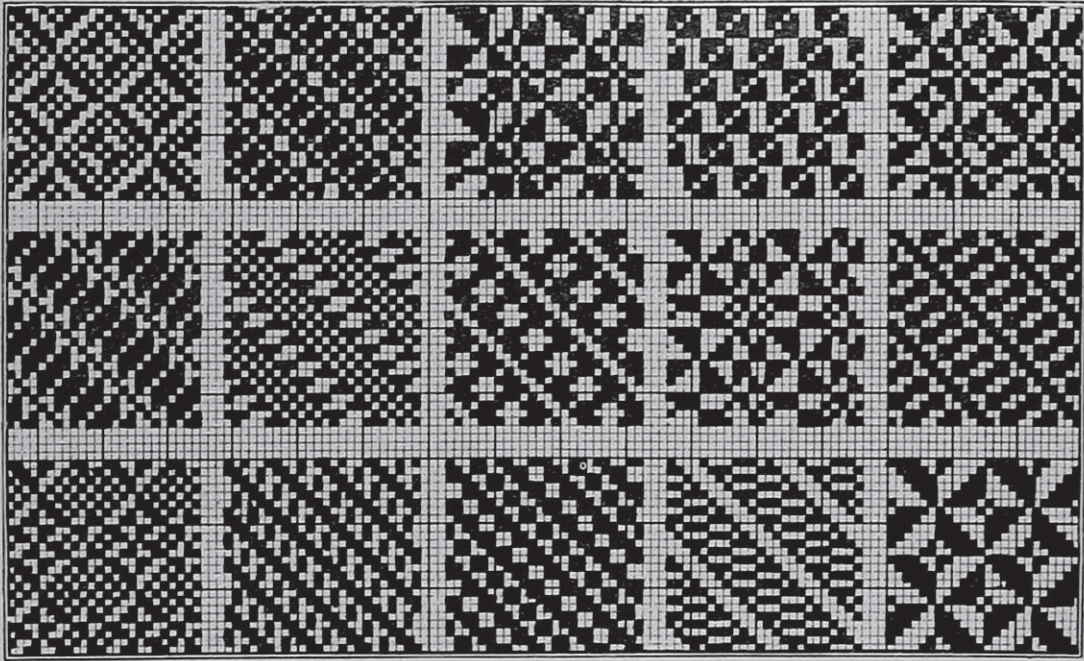

12 X 12

TWELVE HARNESS

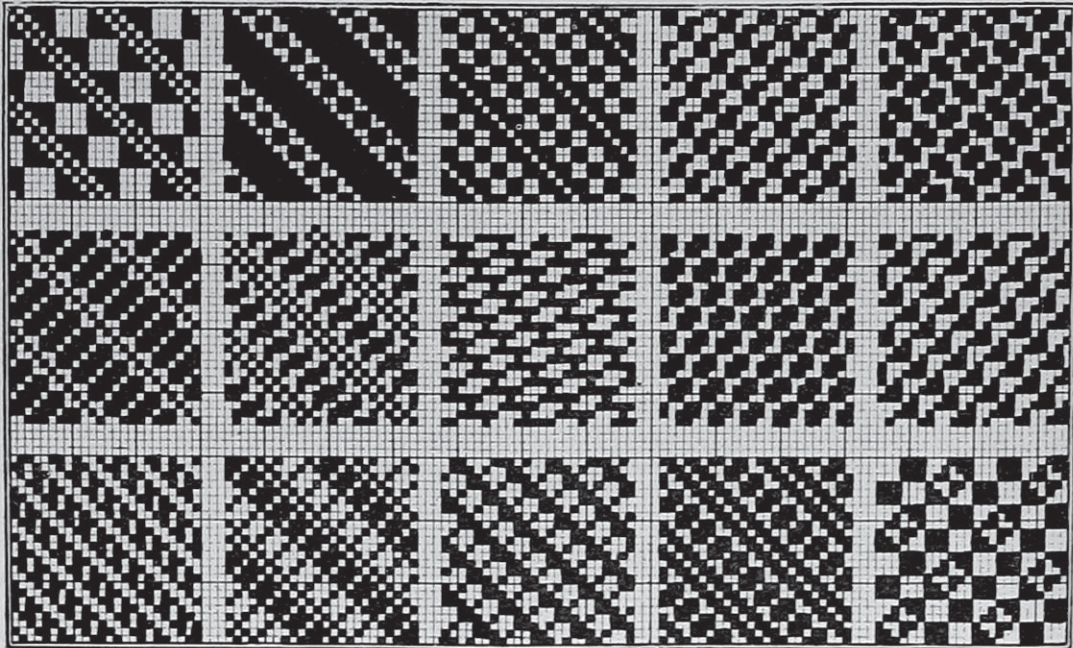

12 X 12

**GEORGE W. CHAPIN
COTTON YARNS**

TAPES, BRAIDS, THREADS
LACE EDGINGS

229 CHURCH STREET 231
PHILADELPHIA, PA.

N. Y. Office, 350 Broadway

R. E. SCHNEEBELI, Res. Manager

LUDWIG LITTAUER

Successor to Moeller & Littauer

**Y
A
R
N
S**

Thrown Silk
Artificial, Shappe and Spun Silk
Domestic and Imported, Plain
Gassed, Mercerized and Polished Cotton
Polished and Glazed Threads
Mohair and Worsted
Tinsel
Turkey Red

**Y
A
R
N
S**

109 GREENE ST., NEW YORK

Best Quality Harness Twine

Alex. D. Stelle, President

Walter H. Rossmässler, Treasurer

Sauquoit Silk Mfg. Company

MANUFACTURERS OF
ORGANZINE, TRAM, TWIST
FRINGE AND HOSIERY SILKS

Fast Dye Organzines for Woolen Manufacturers a Specialty

Mills: BETHLEHEM, PA.
PHILADELPHIA, PA.
SCRANTON, PA.

New York Representatives: WILLIAM RYLE & CO., 54 Howard Street
PHILA. OFFICE: 4015 Clarissa St. (18th St. & Hunting Park Av., Nicetown)
CHICAGO OFFICE: 188 Market St. BOSTON OFFICE: 78 Chauncy St.
Silks For Insulating Purposes

WILLIAM RYLE & CO.

Foreign and Domestic

Spun Silk Yarns and Noils

Domestic Thrown Silk of every description. Fine Pure Dye Silks for the woolen trade a specialty. Importers of European and Asiatic Raw Silk

54 Howard St. NEW YORK

**FIRTH & FOSTER CO.
DYERS and FINISHERS**

OF PIECE GOODS EXCLUSIVELY

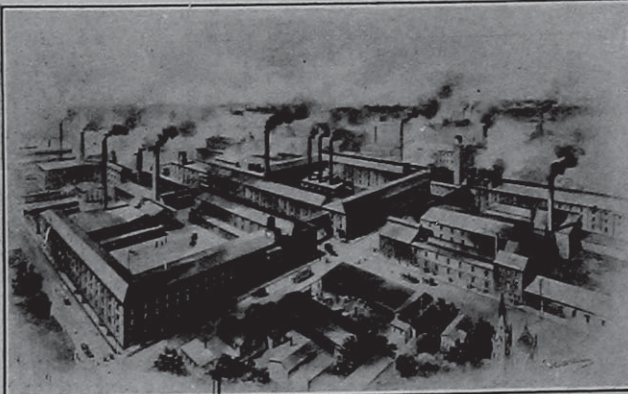

The best equipped plant for the DYEING and FINISHING of fine wool and worsted goods, also silk and wool fabrics.

EMERALD, YORK AND ADAMS STREETS

PHILADELPHIA

NEW YORK OFFICE: Silk Exchange Bldg., Room 702

QUEENSBURY MILLS

H. HODGSON, Pres. and Treas.

FRED. HODGSON, Gen. Mgr.

MOHAIR

FLYER SPUN YARNS *Mohair Tops and Yarns for Weaving Single and 2-ply* ALPACA AND WORSTED YARNS

WORCESTER, MASS.

Good Mills turn out Good Work
Good Work requires Good Soap

"The Best is Good Enough"

THE HOLBROOK MFG. CO.

470 Washington St.,

NEW YORK

Write Dept. P for a Letter Opener—sent free.

Globe Machine and Foundry Co.

(Incorporated)

Frankford, Philadelphia, Pa.

Builders of the

Denn Warping Machinery

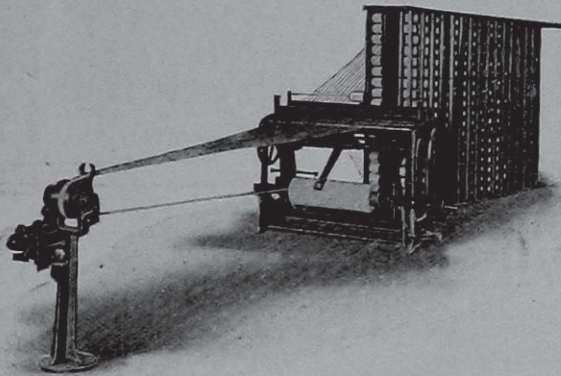

Our New Design Ball Warper

(Patented and Patents Pending)

Spindle Driven
No Slippage
No Lifting

Regular Wind
Ends Square
Drops on Truck

Can Use Three-inch Shells

SAMUEL S. VINAL & CO.

Cotton Dealers & Exporters

BURNT AND RECLAIMED COTTON A SPECIALTY

52 India Street, Boston, Mass.

FREDERICK JONES & CO.

Race above Fourth Street, Philadelphia

TEXTILE DESIGN PAPERS

for all Fabrics

A NEW DESIGN FOR RUGS.

(Patented.)

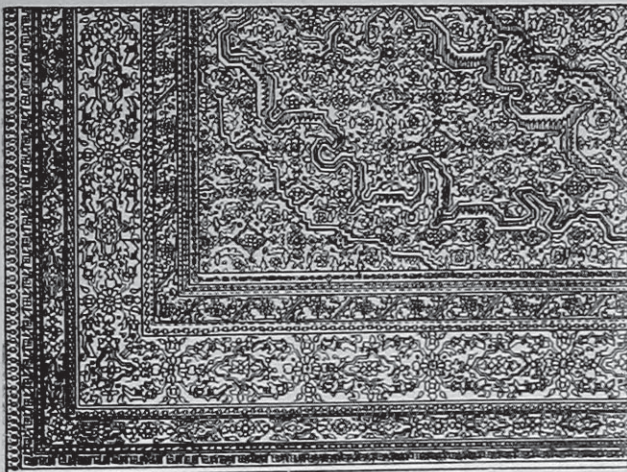

JOHN C. EDWARDS

NATHAN HEARD

LOUIS C. SMITH

CROSBY & GREGORY

Established 1854.

Old South Building -- Boston, Massachusetts

PATENTS AND PATENT CAUSES

Textile Work a Specialty

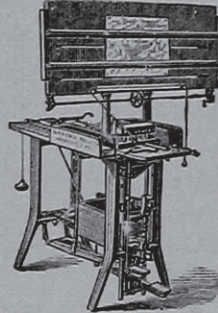

F. G. LENTZ & CO.

**Designers, Card Stampers
and Harness Builders**

FOR ALL TEXTILE FABRICS

Mascher, Waterloo and York Sts.

Both Phones

PHILADELPHIA, PA.

Yates's Patent
AUTOMATIC

SHUTTLE GUARD

Over 800,000 now in use in Great Britain and foreign countries. Adapted for all makes and widths of looms.

TIMOTHY YATES, Richmond St., Preston, Lancs., England (Only Address).

Agents wanted in weaving centres in the United States

"GLAZINE"

For Softening, Filling White and Colored Goods, and Giving a Bright Finish

Inquiries: J. W. CUMMING, Irish Moss Exporter
Clonliffe, Dublin

Code Used A, B, C, 5th Edition

Telegrams: Cumming, Dublin

**CONTRACTION
BY
TWIST**

This instrument will show how much the twist contracts the thread,
also the number of turns of twist per inch.

PRICE, \$25.00

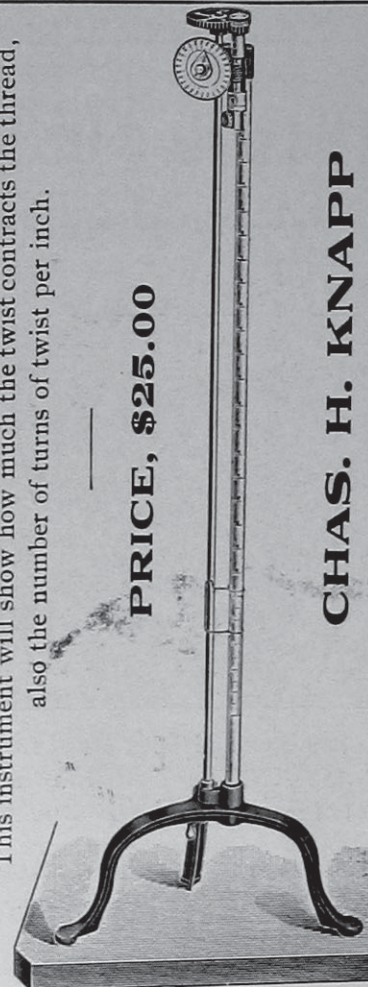

CHAS. H. KNAPP

WAIT and RYE STS. --- PATERSON, N. J.

WORSTED YARNS
RICHARD CAMPION
 Selling Agent for
BRISTOL WORSTED MILLS
HIGHLAND WORSTED MILLS
 300 Chestnut Street - PHILADELPHIA

CHEMICALS AND APPARATUS
FOR THE DYE TRADE
J. & H. BERGE
 Best Bohemian Chemical Glassware and German Porcelain.
 C. P. Chemicals and Reagents, Chemists' Supplies of all kinds.
 95 JOHN STREET, - - NEW YORK

KILBURN, LINCOLN & COMPANY
LOOMS FOR
COTTON AND SILK WEAVING
 FALL RIVER, MASS.

HOWSON AND HOWSON
ATTORNEYS AT LAW
 West End Building, 32 S. Broad Street
 Philadelphia
SOLICITORS OF PATENTS New York, 38 Park Row
 Washington, 918 F Street

The number is ever increasing.
 There is a good reason why.

THE SCHAELLIBAUM GRID

The grid with a comb is getting in general use all over the country. It does the work. You get better cleaning and lose less cotton in the process than by any other grid. : : : : :

The **ROB. SCHAELLIBAUM CO.**
 288 Dyer Street, Providence, R. I.

The West Indies Chemical Works, Limited
 Manufacturing Only the One Product

PURE LOGWOOD
EXTRACTS

WE ARE ABLE TO GIVE YOU THE BEST
WORKS—JAMAICA, WEST INDIES
 (where the Logwood Grows)
NEW YORK OFFICE, 84 WILLIAM ST.

OSWALD LEVER Co., Inc., BUILDERS OF
 TEXTILE MACHINERY
 Lehigh & Mascher Sts. **PHILADELPHIA, PA.**
SPECIALTY: WINDING MACHINERY IN ALL VARIETIES
FOR ALL CLASSES OF WORK

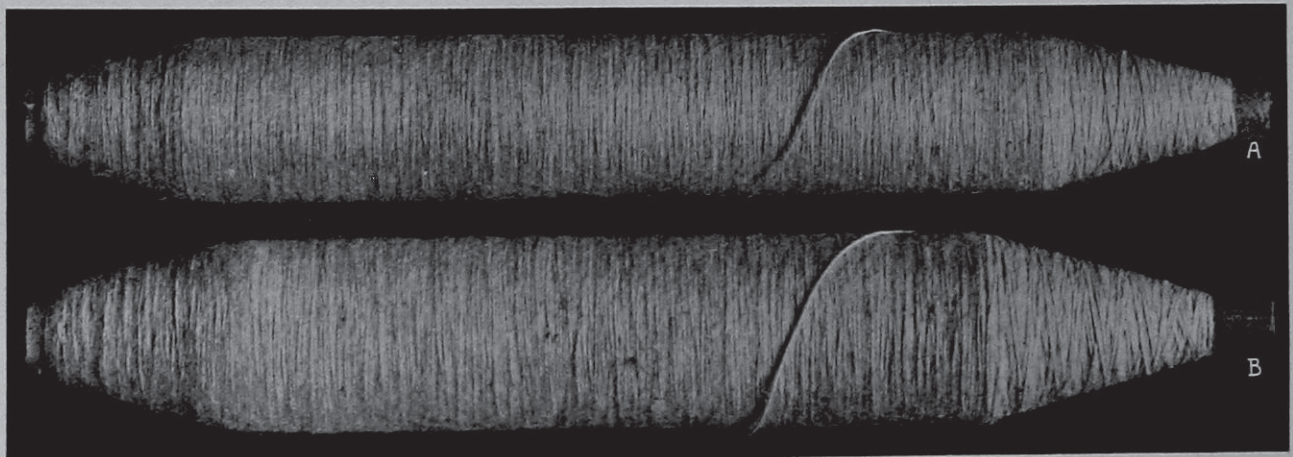

Illustrations, Actual Size, Showing What We Do. We Invite Comparison.

Send Samples for Rewinding
 and We will convince you
 Where you are short.

- A:** Single 25's soft spun Cotton Yarn.
 Amount of yarn on tube 456 grains or 1368 yards.
- B:** Single 12's soft spun Cotton Yarn.
 Amount of yarn on tube 458 grains or 660 yards.

CIBA DYES

Ciba Blue
Ciba Violet
Ciba Red

Vat Dyes for Wool, Cotton, Silk
Fast to Light, Chlorine and Washing

Made by Society of Chemical Industry, Basle

A. Klipstein & Co., New York, American Agents

Announcement:

We beg to announce that in the interest of *our Advertisers* we have facilities for Exhibiting smaller classes of Machinery, Working Models, Supplies and Devices Relating to the Textile Industry; to look after their interest and demonstrate advantages.

For the convenience of the practical men and the busy manufacturers, the Exhibit will be open from 8.30 A. M. to 5.30 P. M. daily and every Tuesday from 7 to 10 P. M.

Full particulars on request.

POSSELT'S TEXTILE JOURNAL, Philadelphia.

MILL NEWS

Philadelphia, Pa. The immense dyeing, bleaching and finishing plant of the Firth and Foster Co. is running full time and are finishing large quantities of Woolen and Worsteds, Men's and Women's wear, also Eoliennes. They are also kept very busy on their various lines of silks.

A. J. Cameron & Co., are operating all of their machinery on full time, running some departments overtime.

The Belgrade Dye Works are now operating on full time after a couple of months' dullness.

The addition to the Shelbourne Mills, manufacturers of men's wear and worsted dressgoods, which doubles the capacity of the plant, has been completed.

T. D. Weston Company, manufacturers of knitted worsted golf gloves, which has been closed since May, will resume operations.

Eighteen additional looms will be installed by Alfred Gordon & Co., manufacturers of cotton worsteds, thus increasing their equipment to 32 looms.

Harry L. Munz, Surpass Knitting Mill, 2048 East William street, manufacturer of ladies' seamless hosiery, will install eight additional knitting machines to his present equipment of twelve machines.

The Brighton Worsted Company will erect a building two and one-half stories high, 159 by 107 feet together with a one-story power-house, 36 by 40 feet, at the southeast corner of O and Tioga streets.

After several weeks' shutdown the

Allen Hosiery Company has resumed operations.

East Brady, Pa. It is reported that the Valley Yarn and Woolen Co. will erect a mill for the manufacture of high-grade knitting yarns. The capital stock is \$10,000.

Birdsboro, Pa. The plant of the Birdsboro Hosiery Mills, operated by W. A. Byer & Son, will be increased by the addition of a brick building 26 feet wide, 55 feet long and 2½ stories high.

Mordansville, Pa. Fire, thought to have been caused by a spark from an engine, destroyed the Sands Woolen Mill, resulting in a loss of \$15,000; no insurance.

West Conshohocken, Pa. The several hundred employes of the Merion Woolen Mills, which has been on short time since last November, are again on

(Continued on page xiv.)

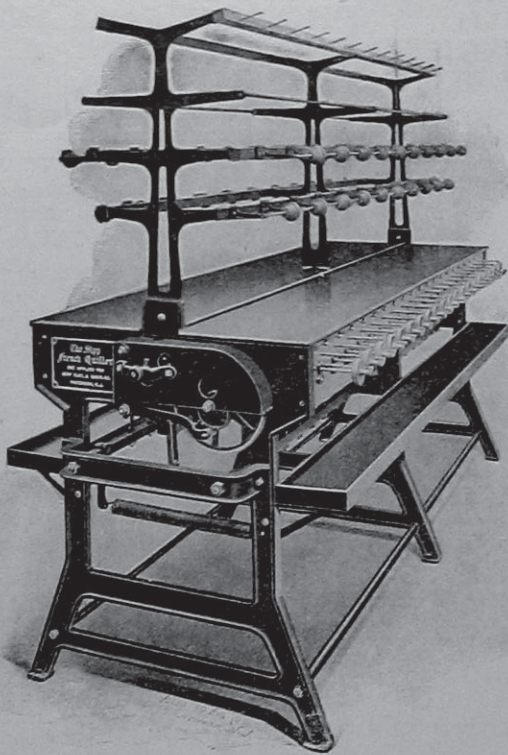

The Sipp High Speed French Quiller Patented

The QUILLER that Will Produce More

GOOD QUILLS

IN LESS TIME

Than Any Other QUILLER Made

$\frac{3}{4}$ of the raw silk quilled in the United States is wound on these machines, aside from their use for soft silk and cotton yarn. : : : : :

Prices and Circulars on Application to

THE

Sipp Electric and Machine
Company

Keen and Warren Streets and Erie R. R.

PATERSON, N. J.

Cost and Accounting Systems
Periodical or Casual Audits

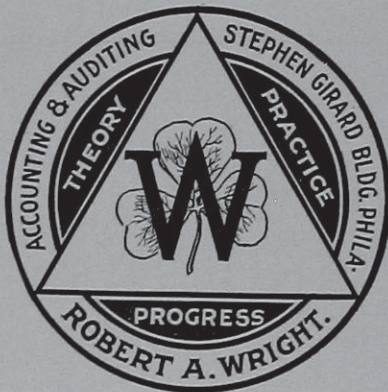

Consultations and
General Accounting

WEIMAR BROTHERS
MANUFACTURERS OF
Tapes, Bindings and Narrow Fabrics
2046-48 AMBER STREET
PHILADELPHIA

WHEN QUALITY COUNTS WE GET THE ORDER



Cuts in this Journal are a sample of our work.

ESTABLISHED 1869

INCORPORATED 1906

The Whitaker Reed Co.

MANUFACTURERS OF

LOOM REEDS OF ALL KINDS

"Royal" Ring Travelers, Mill Wire Goods and Heddles

Worcester, - - Mass.

THEODORE H. STROUSE & CO. 426-428 MARKET STREET,
PHILADELPHIA, PA.
COTTON YARNS, MERCERIZED AND PLAIN.
FINE SINGLE, TWO AND THREE PLY UP TO 200's.
 Sole American Agents for Messrs. Wm. A. Holt, Ltd., Cotton Spinners and Doublers, Bolton, England.

sixty hours a week, with every indication of so continuing indefinitely.

Scranton, Pa. The W. A. Lush Silk Company has incorporated and will engage in throwing, weaving and manufacturing silk, silk fabrics, etc. The capital stock is \$50,000; the plant of the company is nearing completion.

Chester, Pa. The Paterson Mills, which have been idle for several years, have been purchased through Sweeney & Clyde for parties who will manufacture various kinds of hospital supplies, such as absorbent cotton, iodoform gauze, etc., and will employ several hundred persons.

New York. The Ryder Manufacturing Company have incorporated with a capital stock of \$750,000 and will engage in the manufacture of cordage, yarns, etc.

Herkimer, N. Y. The Mark Manufacturing Company, manufacturers of knit sweaters and underwear, which has been closed for a year, will resume operations.

Cohoes, N. Y. The Cascade Knitting Mills, which have been operated on short time for a year, have started up on full time.

Fulton, N. Y. The American Woolen Company is removing the Clipper and one-shuttle Knowles looms from their plant, placing in their stead four-shuttle Knowles looms, which are better adapted for the class of cloth now being manufactured.

Troy, N. Y. The Clark Textile Company's plant, which has been closed down since July, is again in operation.

Lockport, N. Y. The Niagara Textile Company, manufacturers of huck towels and crashes, has purchased a large strip of property next its mill and will build a large addition to their plant, which will double its capacity.

Amsterdam, N. Y. The Gardiner & Warring Co., operating 225 knitting, 30 ribbing and 230 sewing machines on men's cotton underwear have commenced operations in full after being shut down for over three months.

Rahway, N. J. The United Woolen Mills Company has incorporated with a capital of \$125,000 and will manufacture woolen and worsted goods cloth and other fabrics.

Paterson, N. J. Work will soon be commenced on the plant of the Wagraw Company and it is expected that the new mill will start operations on January 1 and give employment to about 700 hands.

Phillipsburg, N. J. John Ramsay & Sons, who recently purchased the plant of the W. H. Ashley Silk Company, are arranging to double the present capacity of 3000 silk spindles.

Millville, N. J. Several hundred new looms are being installed in the plant of the Millville Manufacturing Co.

North Adams, Mass. An additional story is being added to some sections of the Windsor Print Works. Full time is being run and some of the departments are working overtime.

Ware, Mass. All departments of the Otis Company's cotton mill plant are running full time and will continue to do so.

Fisherville, Mass. The Fisher Manufacturing Company will commence operations with 200 looms in a short time.

Lowell, Mass. The Abbott Worsted Mills are operating on a full time schedule of 58 hours per week.

Fall River, Mass. The Merchants' Manufacturing Company is increasing the production of the carding department of its No. 3 mill, by the addition of 6x3 jack speeders, with a total of 5,000 spindles operating on medium counts.

Housatonic, Mass. The Monument Mills, are installing 60 more looms, making 225 in all, engaged in the manufacture of quilts, bed spreads, etc.

Hinsdale, Mass. The Hinsdale Woolen Mill, which has been idle since June, are again in operation. The company has secured a contract for United States army blankets, and with orders for other kinds of blankets in hand, has enough orders to keep the mill running through the winter.

Easthampton, Mass. Operations are being resumed in full in the plant of the West Boylston Manufacturing Company which employs about 1,000 hands who, during the business depression have been working four or five days a week only.

Thompsonville, Conn. Theodore Roosevelt, Jr., has accepted a position as office clerk at the plant of the Hart-

ford Carpet Corporation and will later on go into the wool-sorting department.

South Manchester, Conn. The employees of the Spring Silk Company have been notified that the plant will be moved to Paterson, N. J., where it will be consolidated with the Manhattan Silk Company.

Wauregan, Conn. The Wauregan Cotton Mills have resumed operations on a full time schedule, giving employment to about 650 hands.

Plainfield, Conn. The Lawton Mills Company are erecting a new structure of brick construction, three stories high, 200 by 180 feet, which when completed and equipped with the latest models in cotton machinery, will mean an outlay of about \$258,000 and give employment to about 300 hands.

South Norwalk, Conn. The Muller Gloria Silk Mills Company has awarded the contract for the erection of a one-story factory, 40 by 300 feet to be used as a weaving department.

Manchester, Conn. The Glastonbury Knitting Company, manufacturers of knit underwear, has resumed operations after a six weeks' shut-down.

Nashua, N. H. The Nashua and Jackson Cotton Mills, employing about 4,000 hands who have been on short time for the past nine months have resumed operations on full time.

New London, Conn. The Ninigret Mills Company, recently organized and incorporated, will manufacture silk linings and special colored silk fabrics and will operate in all 125 looms to start with, giving employment to from 100 to 125 hands.

Woonsocket, R. I. The Scotia Worsted Mills has resumed operations on a full time schedule.

Pawtucket, R. I. The Blodgett & Orswell Co. will erect a brick addition to its plant 30 by 68 feet.

Riverpoint, R. I. The silk mill of the Pawtucket Valley Textile Company which has run without interruption since it was started in the old Pike Mill nearly three years ago is running day and night with two sets of hands.

Dexter, Me. After a period of operating on short time the mills of the Dunbarton Woolen Company have resumed full time.

(Continued on page xvi).

We are prepared to prove that Peroxide of Sodium for

Bleaching

*animal & vegetable fibres
or their mixtures
is the best.*

*Roesler & Hasslacher
Chemical Co.
New York*

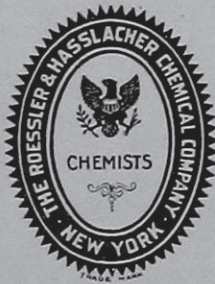

WOONSOCKET YARN GASSING MACHINE

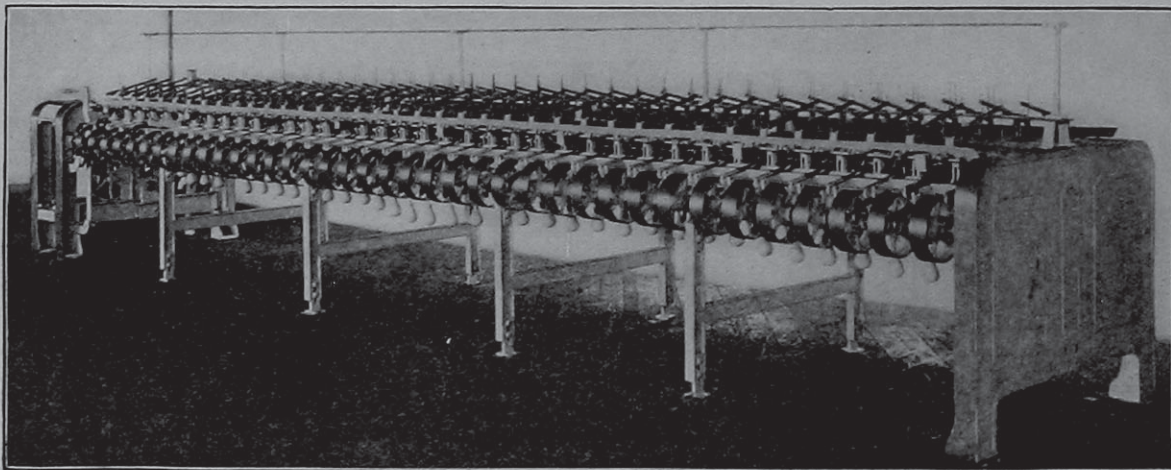

Woonsocket Machine & Press Company,

WOONSOCKET,
R. I.

Builders of Cotton and Woolen Machinery

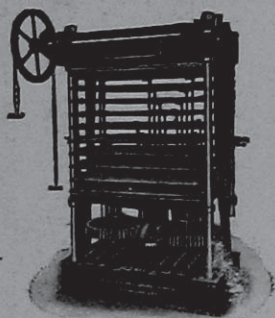

"HURRICANE" DRYERS

For Wool, Cotton Stock, Yarn, Knit Goods, Etc.

Belt-Driven **FANS** Motor-Driven

Power Screw **PRESSES** Hydraulic

WRITE FOR CATALOGUES

THE PHILADELPHIA DRYING MACHINERY CO.,
6721 GERMANTOWN AVE., PHILADELPHIA, PA.

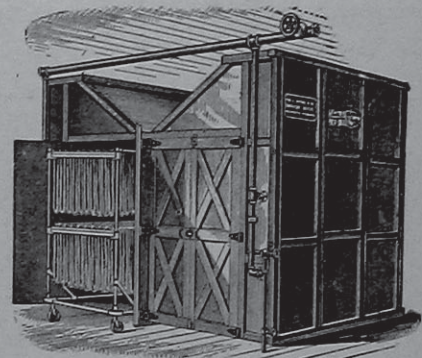

Boston. Providence. Philadelphia. Chicago. Charlotte. Albany. Toronto, Can.

FARBENFABRIKEN OF ELBERFELD CO.,

IMPORTERS OF ANILINE & ALIZARINE COLORS

P. O. Box 2162

NEW YORK

117 Hudson Street

New England Butt Co.

Providence, R. I.

Braiding Machinery, both American and German types, for making Dress Braids, Shoe and Corset Laces, Underwear, Trimmings, and all kinds of Round and Flat Braids.

NORTHEASTERN TRADING COMPANY

IMPORTERS AND DEALERS

Russian, China, Turkey, Iceland and Other Foreign
Wool, Hair, Mohair, Eiderdown and Skins

New York Office:
74-76 WALL STREET

114 Arch Street
PHILADELPHIA, PA.

Boston Office:
620 ATLANTIC AVE.

Shelby, N. C. The Shelby Cotton Mills have completed arrangements for the preparation of plans and specifications for the erection of buildings to accommodate the 2,400 twisting spindles, 6,500 spinning spindles and complementary machinery to be added to their present plant.

Lexington, N. C. It is reported that the Lexington Knitting Mills is planning to rebuild its plant, which was destroyed by fire recently.

Concord, N. C. Construction on the addition to the plant of the Young-Hartsell Mills Co. has been commenced. This addition will be 112 feet long by 50 feet wide, and will provide space for two warping machines and other complementary equipment for the production of weaving yarns.

Elizabeth City, N. C. The Elizabeth City Hosiery Mills, which have been

running on half and short time since January, have resumed operations on full time.

Marion, N. C. The Mt. Ida Hosiery Mills will erect a 40x110-foot building and install fifty knitting machines, with accompanying ribbers, loopers, driers, press, singers and dyeing machinery.

China Grove, N. C. The Patterson Manufacturing Co., who have been operating on half time for several months has resumed on full time.

Hope Mills, N. C. The Hope Mills Real Estate and Investment Company contemplate establishing a mill to knit hosiery, probably installing from 30 to 40 machines at the start.

Columbia, S. C. The Columbia Duck Mills, which have been closed on account of repairs will resume operations in full and operatives will be kept on a 60-hour per week basis.

Spartansburg, S. C. The Saxon Mills will make an addition of 10,000 spindles and 350 Draper looms.

Hartsville, S. C. It is reported that the Hartsville Cotton Mill will install 4,000 additional spindles to their present equipment of 33,000 spindles and 800 looms on the production of print cloth.

Lando, S. C. The Manetta Mills will install additional machinery in the building which has been completed.

Augusta, Ga. The Enterprise Manufacturing Co. has resumed with 400 looms in operation, giving employment to 200 hands.

La Grange, Ga. The stockholders of Unity Cotton Mills have decided to build immediately a new cotton mill about the same size as the Unity Mill at an estimated cost of between \$400,000 and \$500,000, and the contracts for the buildings and machinery will be let at once.

EXPLANATIONS FOR THE CHART OF WEAVES ON

“Textile Designing Simplified.”

The object of this chart is to show how easy weaves for all classes of Textile Fabrics can be constructed; it will be a search light in the misty matters in the field of designing Textile Fabrics. Keep this chart of weaves for reference. Millions of new weaves can be obtained by it.

All weaves for Textile Fabrics have their foundation in Plain Twills and Satins.

PLAIN.—This weave and its sub-divisions are explained on the chart in the top row by 16 weaves, the sub-divisions covering common, fancy and figured Rib and Basket weaves.

TWILLS.—The foundation of constructing regular (45°) twills is shown by rows 2 and 3 with twenty six weaves, covering twill weaves all the way from 3 harness up to 13-harness. The sub-divisions of twills are quoted next on the chart, being Broken twills, Skip twills, Corkercrows, Double twills, Drafting twills, Curved twills, Combination twills warp drafting, Combination twills filling drafting, 63° twills, 70° twills, Wide wale twills, Entwining twills, Checker-board twills, Pointed twills, Fancy twills, thus covering every sub-division of twill weaves possible to be made.

SATINS are next shown, giving also their sub-divisions, viz: Double satins and Granites.

HOW TO PUT A BACK FILLING ON SINGLE CLOTH is shown below the satins by two examples, and at its right hand is quoted the principle of

HOW TO PUT A BACK WARP ON SINGLE CLOTH.

On the bottom line are given the four steps for:—

THE CONSTRUCTION OF DOUBLE CLOTH, 2 @ 1; and above the same one example, with the arrangement 1 @ 1.

THREE PLY CLOTH is shown by one example.

HOW TO BACK SINGLE CLOTH WITH ITS OWN WARP is shown by two examples.

WEAVES FOR SPECIAL FABRICS are quoted: Tricots (warp, filling and Jersey effects), Rib fabrics, Honeycombs, Imitation Gauze, Velveteen, Corduroy, Chinchillas, Quills, Plush, Double-plush, Tapestry, Crape, Terry, Worsted coating stitching, Huckas, and Bedford cords

HOW TO WORK THIS CHART OF WEAVES.

CAPITAL LETTERS of references refer to the plain weave and its sub-divisions.

SMALL LETTERS of references refer to twills and their sub-divisions.

NUMERALS of references refer to satins and their sub-divisions.

EXAMPLE.—How to ascertain the construction of the weave at the right hand top corner of the chart; being the figured rib weave marked C C? These two letters of reference mean that said figured rib weave is nothing else but the combination of the 2-harness 6 picks common rib weave warp effect C, and the 6 harness 2 picks common rib weave filling effect C'.

EXAMPLE.—The letter of reference *c*, underneath the first broken twill indicates that the same is obtained from the $\frac{1}{3}$ 4 harness twill *c*, (third weave on the second row; in other words, letter of references below each weave of any of the various sub-divisions refer always to the corresponding foundation weave.

EXAMPLE.—Twill *q* and *o*, are the foundation for the eight combination twills filling drafting, said common twills are drafted 1 @ 1, the different designs being obtained by means of different starting.

EXAMPLE.—The wide wale twill *w'*, has for its foundation the 63° twills, marked also respectively *l'* and *w'*, the latter two weaves have again for their foundation respectively the common twills marked *l* and *w*.

EXAMPLE.—Granites marked 8 have for their foundation the 8-leaf satin, such as marked 12 the 12-leaf satin.

EXAMPLE.—Backed by filling *e* 8, means the common $\frac{2}{3}$ 4-harness twill *e*, (fifth weave on second row) and the 8-leaf satin is used in the construction of this weave.

EXAMPLE.—The complete design of double cloth, marked *e* 8 A, means that the common $\frac{2}{3}$ 4-harness twill (*e*), the common plain (A) and the 8-leaf satin (8) are used in the construction.

EXAMPLE.—Rib fabric A, indicates that the plain weave forms the foundation.

It will be easy to substitute different foundations in constructing weaves for heavy weights. In reference to single cloth weaves we only want to indicate that by following rules shown in the chart, millions of new weaves can be made up from it.

Keep this chart on hand for reference. Only 144 weaves are given, yet they will guide you to make millions of new weaves.

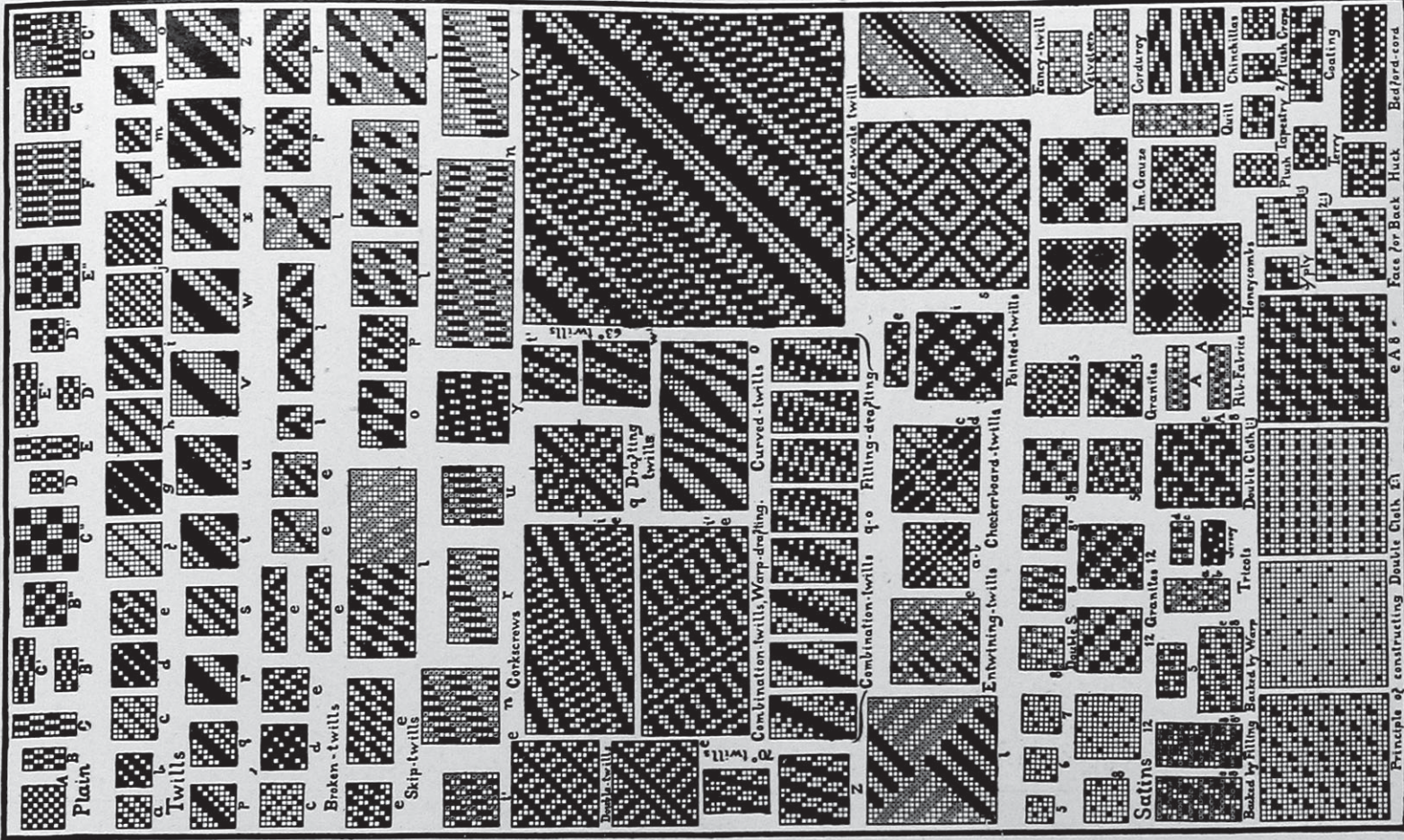

Principle of constructing Double Cloth 11

LOOMS

FOR WOOLENS, COTTON, SILKS
AND ALL SPECIAL FABRICS
DOBBIES, JACQUARDS, WOOL COMBS
PRINTING DRUMS, REPAIR PARTS and SUPPLIES

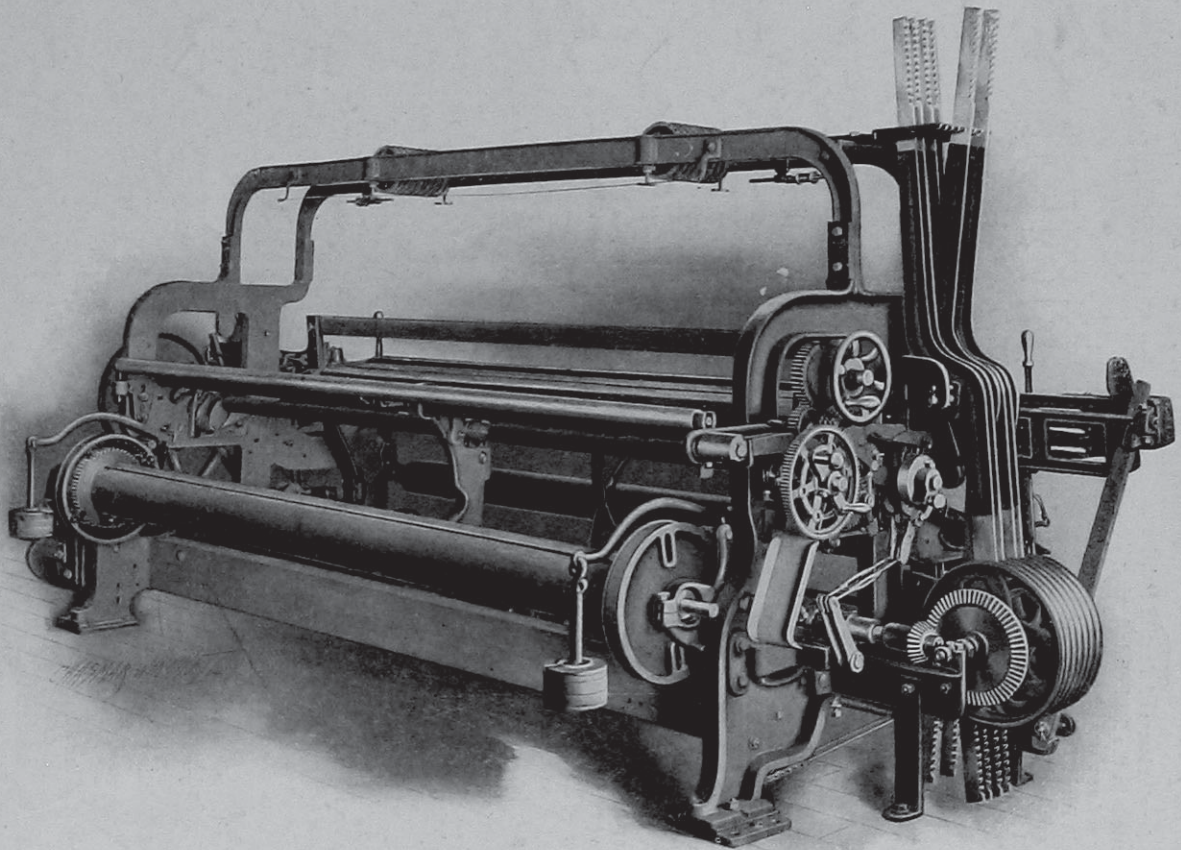

CROMPTON & KNOWLES LOOM WORKS

WORCESTER, MASS. PROVIDENCE, R. I. PHILADELPHIA, PA.

Southern Representatives—ALEXANDER & GARSED, Charlotte, N. C.

Foreign Representatives—HUTCHINSON, HOLLINGWORTH & CO., Ltd., Dabcross, England