

# THE SACO-LOWELL BULLETIN

OCTOBER 1928



SPECIAL  
GREENVILLE SHOW  
NUMBER

# The Saco-Lowell Exhibit

at the Greenville Textile Show

October 15<sup>th</sup> - 20<sup>th</sup>

Will be a display of modern textile development.

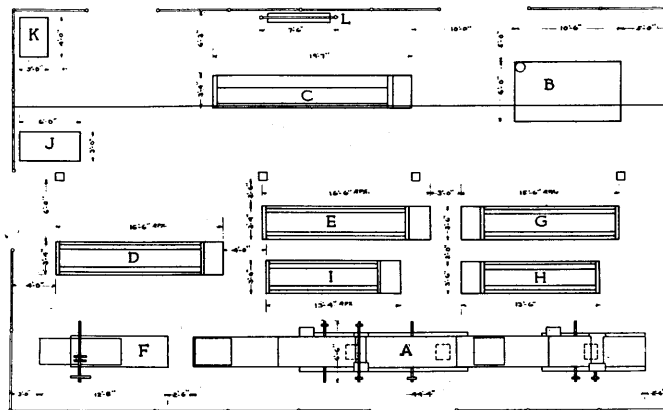

SACO-LOWELL'S BOOTH  
No. 216

- A—One Process Picker  
with Synchronized Control—See pp. 3 to 6 in this bulletin.
- B—Revolving Flat Card  
with Continuous Stripper—See p. 2 in this bulletin.
- C—72 Spindle 7" x 3½" Roving Frame  
with Constant Motion Chain Drive—See pp. 8 to 10 in this bulletin.  
Making 6.50 H. R. from 2.10 H. R. in creel.
- D—96 Spindle 3¼" gauge Spinning Frame  
with Saco-Lowell Long Draft Spinning (LeBlan-Roth Patent)—See pp. 11  
to 14 in this bulletin.  
Spinning 50s yarn from 6 H. Roving double.
- E—96 Spindle 3¼" gauge Regular Spinning Frame—See pp. 16 to 18 in this  
bulletin. Spinning 50s yarn from 10 H. Roving double.
- F—No. 4 Bale Breaker  
with Automatic Electric Control—See p. 7 in this bulletin.
- G—Large Package Spinning Frame—See p. 15 in this bulletin.  
64 spindles, 4½" gauge, 3" ring, 9" traverse.  
Spinning 7s yarn from 1.10 H. R. in creel.
- H—80 Spindle Fine Twister—See p. 24 in this bulletin.  
Twisting 100s—2 ply.
- I—40 Spindle High Speed Twister—See pp. 19 to 24 in this bulletin.  
Twisting 7s—3 ply.
- In the Universal Winding Co.'s Booth  
Saco-Lowell High Speed Warper—See pp. 26 to 28 in this bulletin.

# THE SACO-LOWELL BULLETIN

*Issued monthly in the interests of efficient mill operation by the*

SACO-LOWELL SHOPS

147 MILK STREET, BOSTON

CHARLOTTE GREENVILLE ATLANTA

---

VOLUME I

OCTOBER 1928

NUMBER 8

---

## At the Greenville Show

**T**HE Saco-Lowell Exhibit at the Greenville Show will display such an unusual number of new Textile Machinery developments that it is certain to attract a great deal of attention. We sincerely hope that you will be present and will make our booth your headquarters. We not only will do everything in our power to help you enjoy your visit, but are sure that you will see many new developments in textile equipment which will be of vital interest to you.

We wish to call your attention to our Revolving Flat Card with built in Continuous Stripper. This is our first announcement of this device, and we are sure it will be one of the most interesting exhibits at the show. You will also find of interest our One Process Picker with Synchronized Control; Long Draft Spinning; Large Package Spinning; Roving Frame with Constant Chain Drive Mechanism; and High Speed Twister. In addition to the above, we will show our standard Spinning Frame and regular Twister, each having a number of new elements of design which help to make them the most efficient frames obtain-

able. Another interesting machine on display will be our heavy Bale Breaker with the new Saco-Lowell Electric Control which automatically regulates the flow of stock from the Bale Breaker to the Breaker Pickers.

In the Universal Winding Company's booth there will be shown our High Speed Warper, in conjunction with the Universal Magazine Creel.

All of the above machines, with the exception of the Bale Breaker and One Process Picker, will be in actual operation. One point which we wish to stress particularly is the fact that all the equipment on display in our booth will be stock machines in every way. In design, finish and workmanship, they will be exactly as furnished to the mill.

The following pages in this Bulletin describe briefly each of the machines mentioned above. The only way to really appreciate the merits of this equipment, however, is to see it in operation. So, come to the Greenville Show, make yourself at home in our booth, and examine for yourself the latest developments in textile machinery.

---

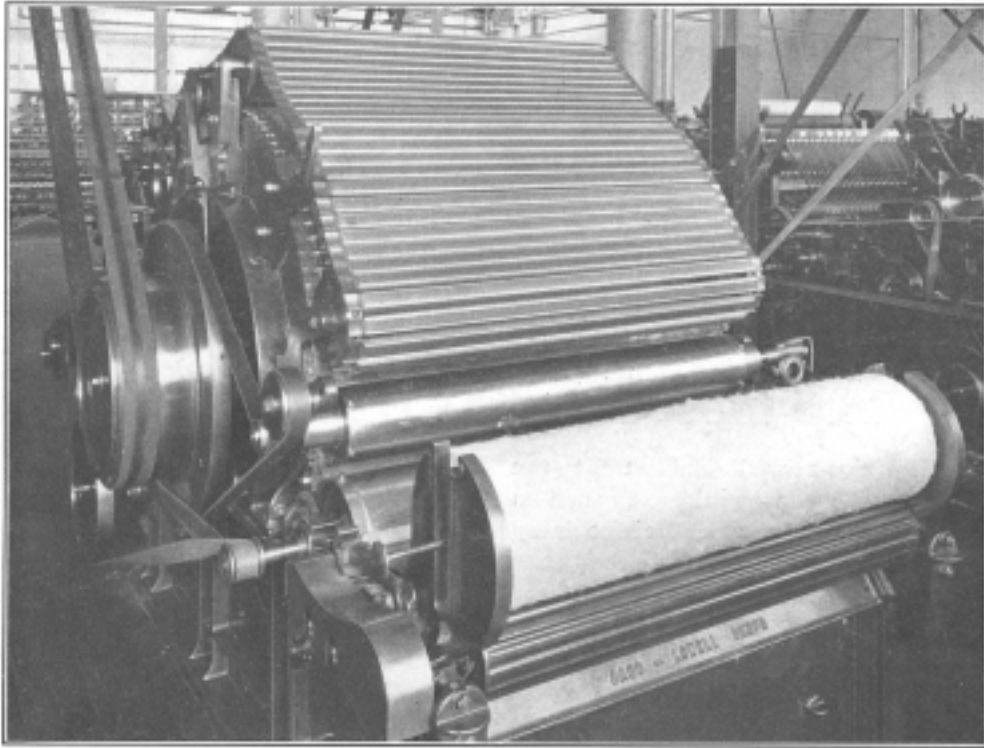

## The Saco-Lowell Card *With Continuous Stripper*

THE Saco-Lowell Shops, ever since they manufactured the first Revolving Flat Card made in America in 1888, have had as their goal, a Card that need never be stripped. A few years ago we developed a very satisfactory mechanical Stripper which went far in reducing the labor cost of this operation and removing the dust, caused by hand stripping, from the Card room. However, that did not eliminate the evil of stripping, although it did much to lessen it. In the last two or three years there have been various ways devised to do away with Card strip-

ping, but up to the present they have not been generally accepted; although the theory on which these devices were based was considered correct, they needed a great deal of simplification and alterations in design to make them of practical value. We have been working along the same lines for a number of years and are now developing a Continuous Card Stripper that we believe will be found simple in design, effective in operation and inexpensively applied. The above cut shows our Card with built-in Continuous Stripper.

---

---

## Saco-Lowell One-Process Picker

### *With Synchronized Control*

**J**UST as improved opening machinery, the general use of the Vertical Opener, etc., made two-process picking possible, so has the further improvement in opening and cleaning of the last three years made one-process picking a practical and economical proposition. The only element needed was the introduction of a suitable One Process Lapper.

One-process picking has been used in Europe extensively for the last few years, and the type of machine used has usually been an ordinary three-beater picker with an Evener at the first section. In this type of machine there is a great deal of cotton in process between the Evener and the Calender and this has been the source of uncertainty in the minds of mill

men. It is certain that there are three places in the lap subject to unevenness, one at the stopping and starting, when the full lap knock-off operates, and one on each screen. In contrast, there is but one such place where a single beater machine is used.

It became evident that this form of One-Process Picker could not meet American mill conditions, and that, if American mills were to profit by this system, a special Lapper must be designed to meet existing conditions. Our engineers were, therefore, prompted to design and build a totally new One Process Lapper which would be adapted to the requirements under which American mills operate.

Our One-Process Picker, as can be seen



A recent installation of Saco-Lowell One Process Pickers

---

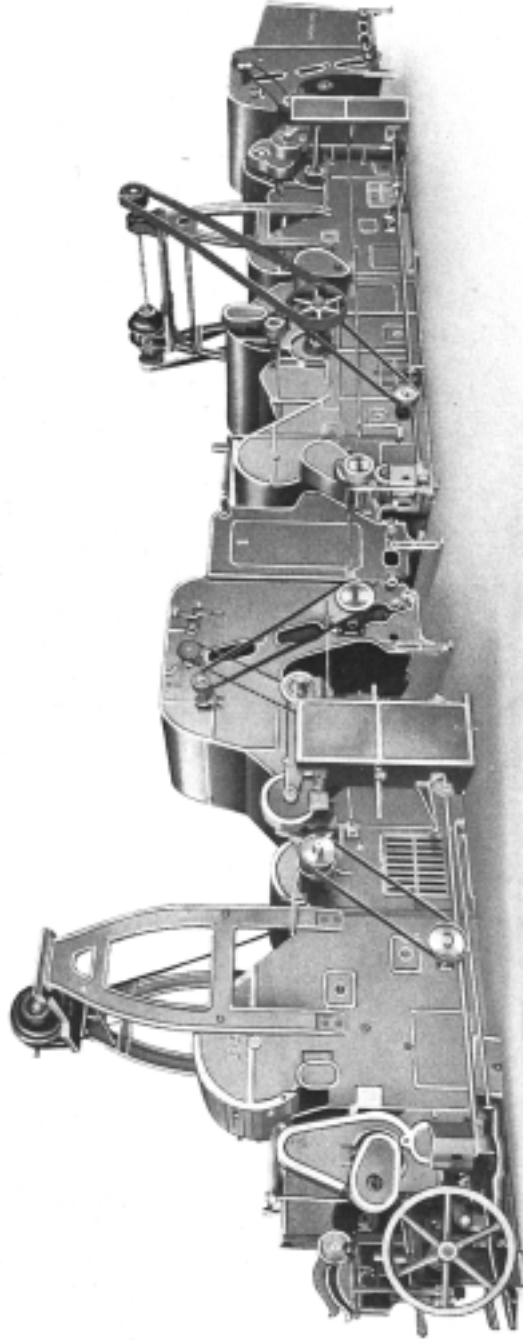

The Saco-Lowell One Process Picker with Synchronized Control

from the accompanying cuts, is made up of an Automatic Feeder, a 24" Buckley Section with Evener, a second 24" Buckley Section, an Intermediate Feeder, and a 16" beater section with Evener and Calender Head. This is in reality nothing more than a two-beater breaker coupled to a one-beater finisher by means of the Intermediate Feeder.

The principal object kept in mind in designing this machine was to retain as many as possible of the advantages of the usual two-process picking,—the equivalent of doublings and the uniformity of lap produced by a one-beater finisher. The introduction of a Feeder between the first two Buckley Sections and the last blade section accomplishes this result.

The theory on which this machine is designed is, briefly, that sufficient cleaning can be done in the opener sections and a rough evening accomplished, to the extent of delivering a sheet within 5% of constant to a Feeder. This Feeder then provides a certain amount of mixing which offers a satisfactory substitute for the ordinary blending on the finisher apron. At the same time it provides a very constant feed to a one-beater Lap-

per, because of the constant level at which the cotton in the hopper is maintained. There can be but one uneven spot in each lap and that is at the stopping and starting.

The secret of success in our One-Process Picker lies in the perfectly synchronized control between the two units. In order to obtain a good lap, the flow of stock through the entire machine must be under control and the level of loose stock in the Intermediate Hopper kept constant. To accomplish this we have disconnected the pedals from the cone frame of the first Evener, inserted a rake in the Intermediate Hopper, and, through suitable linkage, connected this rake to the belt shipper of the cone frame. The control of the stock level in the Intermediate Hopper is therefore automatic, any variation being compensated for by a variation in the feed of the first Feeder and feed rolls. The rolling action of the stock against the rake breaks up any tendency to form into a lap and aids in giving the desired mixing effect necessary for proper blending. The complete machine is perfectly synchronized.

The advantages which were to be expected from the One-Process Picker have

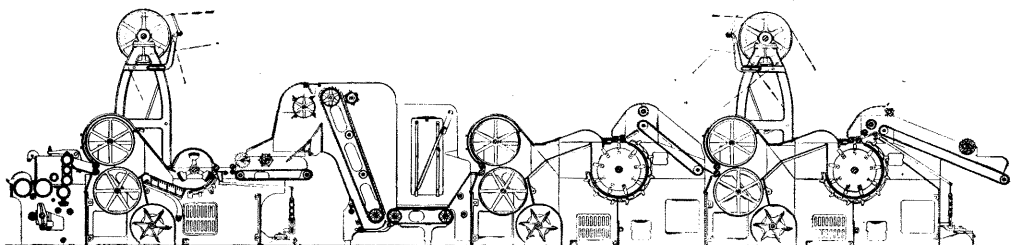

Cross section of One Process Picker

been realized in the various installations we have made. Others, which were not anticipated, have become apparent. Of course, the main considerations were quality and labor saving. The latter is immediately evident as there is no handling of stock from the Bale Breaker until the finished lap is removed from the calender ready for the card room. The evenness of lap is better than could be expected from two-process picking. This is due to the fact that in any lap the density varies from the outside of the lap, where the stretch has released some of the effect of heavy calendering, to the inside next to the roll where the stretch is minimum. Therefore, proper creeling of laps on the apron of a finisher picker delivers four different densities of cotton to the Evener at the same time. As the Evener weighs by measuring the thickness, this change of density is a serious defect, particularly where the operatives are careless in creeling.

The yard for yard weighings are excellent and show a remarkable steadiness. There are no wide variations such as are present in the finisher laps where careless creeling causes piece-outs and doublings. The production is considerably above that of the Finisher, 300 to 350 pounds per hour for a 12-ounce lap proving not at all excessive. The 24" Buckley has proven its supremacy over all other sizes and styles of beaters, not only in pickers but also in our No. 12 Lattice Opener and Cleaner, as the most efficient cleaning machine and only type of large beater that will form a good sheet. By its use in the first two sections of the One-Process Picker, it is possible to reduce the beating to a minimum, and, at the same time, a high degree of cleaning is obtained

through the eighty Grid Bars which cover 270° of the cylinder surface. Such beating as is done on the final beater is on well-opened, loosely sheeted stock instead of on four heavily calendered sheets held tightly by the feed rolls. This is a very advantageous feature. Foreign matter that remains in the lap is so loosely held that it is readily removed by the licker-in of the Cards. The sliver from the Cards shows remarkably even, as determined by numerous weighings.

The mills which are using this machine tell us that the small number of laps lost is almost incredible and that their yarn is better in every way than that made from laps on the old two or three process picking.

The superiority of our machine is undoubtedly due to four principal features; first, the general design followed that has always made Kitson pickers a superior product; second, the synchronized control of Eveners and Rake in the Intermediate Hopper; third, the beating of loose, fluffy stock by the "finisher beater" instead of four hard laps; and fourth, the stronger yarn it is possible to produce because of the gentle treatment of the cotton. The last 16" beater is the only one where the stock is beaten from off its feed rolls, as the first two 24" Buckleys gently handle loose open stock that is sheeted from above.

Although this machine has been on the market but about three months, we have already sold over thirty for both Northern and Southern mills. Those that are now installed are giving such excellent results that we feel confident that One-Process Picking will soon become the rule rather than the exception.

---



## Bale Breaker with Automatic Electric Feed Control

(Patented)

THE problem of properly feeding the Bale Breakers to furnish exactly the right quantity of cotton to the Distributor and Feeders has been a difficult one. It has generally been operated by a system of signals from the Picker Room to the Opening Room and depended on the operatives in both departments always being vigilant. If too great a feed is used, the Distributor overflows on the floor, and the surplus must be taken care of. If the feed is too small, the last feeders in the line do not receive their normal supply, and light laps result. If a feeder is shut down for any reason, a surplus is created, and overflow occurs. To overcome these conditions, we have brought out and patented an electric control which is very effective.

The lifting apron of the Bale Breaker is driven by a small motor equipped with a magnetic starting control which is connected to a switch at each gate of the distributor. These switches are coupled in parallel and are arranged to be opened and closed automatically by the gates of the distributor. When any gate is opened, the motor starts up and a normal supply of cotton goes through to the feeders, continuing as long as any gate is open. When all gates are closed, that is, when all feeders are full, the switches are all open, and the motor stops, shutting off the feed of the Bale Breaker. Therefore, it is only necessary to arrange the feed of the Bale Breaker to furnish a slight surplus over maximum requirements to insure suffi-

cient supply for all feeders and at the same time to insure no overflow that must be picked up from the floor.

A further advantage is that by increasing the feed somewhat above the normal supply, all the feeders have an equal chance at the feed, and a more nearly constant level is maintained in the hoppers, resulting in a more even feed to all the breakers and more even laps.

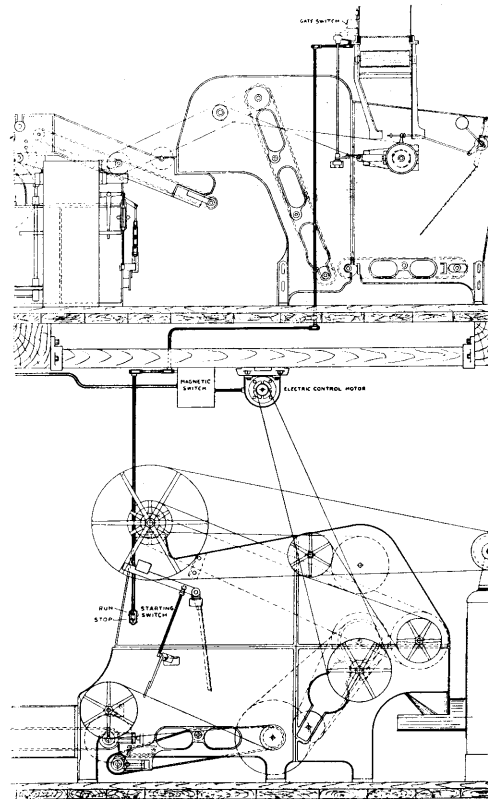

Diagram of Saco-Lowell Electric Feed Control.



Saco-Lowell Roving Frames

## Saco-Lowell Roving Frame

### *With Constant Motion Chain Drive*

FOR many years Saco-Lowell Roving Frames have had a high reputation for advanced design, ruggedness of construction, smoothness of operation, and quality of production. One of the greatest improvements we have recently made is the development of a constant motion chain drive mechanism to take the place of the former swinging gear known as the "Horsehead."

The majority of manufacturers of Roving Frames in this country and abroad have used a swinging link motion to connect the gear on the differential, or the sleeve gear of the compound, with the gear on the back bobbin shaft. This link motion and the gears are not entirely satisfactory, as it affects the tension of the roving, causing the ends to slacken when the rail is running down and to tighten on the up stroke of the traverse. The longer the traverse of the rail, the greater the change in the tension, and this change becomes very considerable on longer traverses. This unevenness of the winding is caused by the driven gear, carried by the swing arms, rolling over the bobbin drive gear.

Our engineers have been experimenting for years with the idea in mind of perfecting a drive that would overcome the difficulties mentioned above, and, as a result of this work, we are now in a position to offer as standard equipment on our Roving Frames a chain drive by means of which a uniform tension can be obtained, with no stretch in the winding of the roving.

In the design of the Saco-Lowell Constant Motion Chain Drive, we have observed the weaknesses in equipment previously designed and have overcome them by driving from the main shaft over a compensating or jockey gear, connecting the two bobbin shafts, namely the front and back bobbin shafts, with one and the same chain. The equipment is arranged with a device, on the lower side of the chain, which keeps the chain uniformly taut at all positions of the traverse of the bolster rail. The gain and loss, or stretching of the roving, is wholly eliminated by the compensating jockey gear over the front bobbin shaft and we lay great stress on this particular point

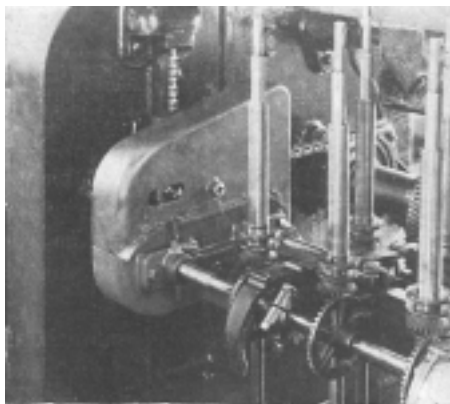

Chain Drive with Cover in place.

of design. There are no spur gears in the bobbin drive on the main shaft or on the back and front bobbin shafts or between them.

The chain itself is of sturdy design, its durability proven by experience. The

sprockets are adequate and they are as large in diameter as the space will permit. The bearings and the method of lubrication are of advanced design. The whole equipment, the sprockets and the chain, is enclosed to prevent accidents, but the cover is designed to be extremely easy to remove for inspection or application of parts. The design of this drive is such that it can be applied very readily to existing Saco-Lowell Roving Frames.

It is well known that a Roving Frame must be of unusually heavy, strong construction; it must be so designed that the greatest strains fall upon the heaviest parts; its builder motion must be dependable and positive; and its many gears must run as quietly and with as little vibration as possible. We have spared neither quality of material nor skilled workmanship to maintain these requirements. We have recently replaced the cast iron beam by one of hot rolled steel which is far stronger, lighter in weight, and will stand a great deal more abuse in transportation. It is unbreakable.

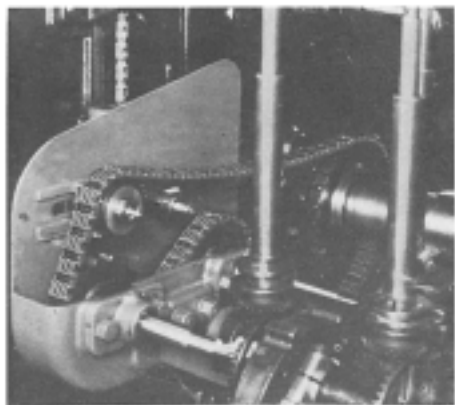

Front view of Chain Drive with Cover off.

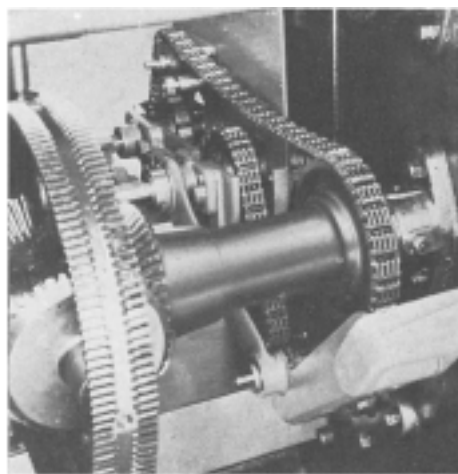

Back view of Chain Drive with Cover off.

We have also made many other minor improvements, among which we might mention the broach coupling on the spindle and bobbin shafts. This coupling replaces the former coupling gears and also the pin coupling which has been in active use for some years. In broaching this coupling we find that this is more rigid and truer running. It is always in line and has never had a replacement on any installation that has ever been entered in a mill. The mechanical feature of this broach coupling and general mechanical construction make it similar to the broach gear now used in automobile transmissions.

It is small improvements such as these, which we are constantly adding to our line of equipment, that help make our machines of such high quality. Minor mechanical improvements are often overlooked by the mill, but they are great factors in reducing the cost of maintenance.

## Long Draft Spinning

WE now have in operation over one hundred thousand spindles of our Long Draft System (Le Blan-Roth Patent). This system has met with such success, has so consistently made an *evenner* and *stronger* yarn at *substantially lower costs*, that the textile industry as a whole is beginning to realize its true economic significance. Orders have lately been rapidly increasing in volume until now we have just closed a contract for a complete 50,000 spindle installation of this system.

The reasons for the exceptional success of our system lies in the fact that both in theory of operation and mechanical design it is far simpler, more effective and cheaper to run, than any such system yet devised. It is the only system we know of that will successfully meet the stringent demands under which American mills operate.

It should be remembered that Long Drafting is simply better drafting. As it is better drafting than we have had heretofore, so we are enabled to accomplish longer drafts than have been possible heretofore. It is one more step, and a very important one, in the orderly and logical advance in the practice of Spinning.

The theory of Long Draft Systems is based on the slip draft principle. This principle has received such universal acceptance within the last few years, that it is not necessary to elaborate upon it here. The weakness of this principle was

in its adaptation to regular Three-Roll Spinning, inasmuch as it was impossible to obtain a proper break draft between the back and middle rolls. In our opinion, this difficulty with the break draft was so serious as to demand improvement before the system could be recommended for general use.

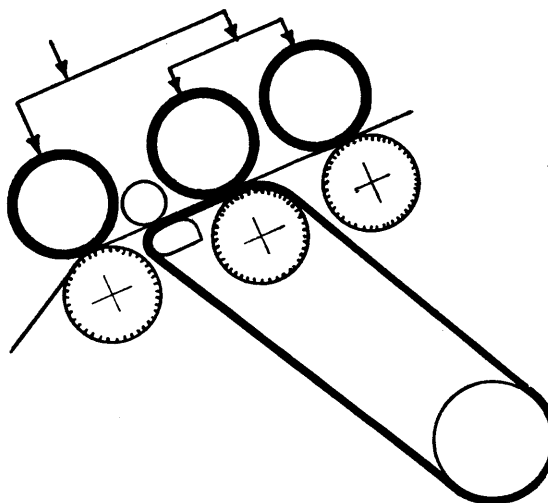
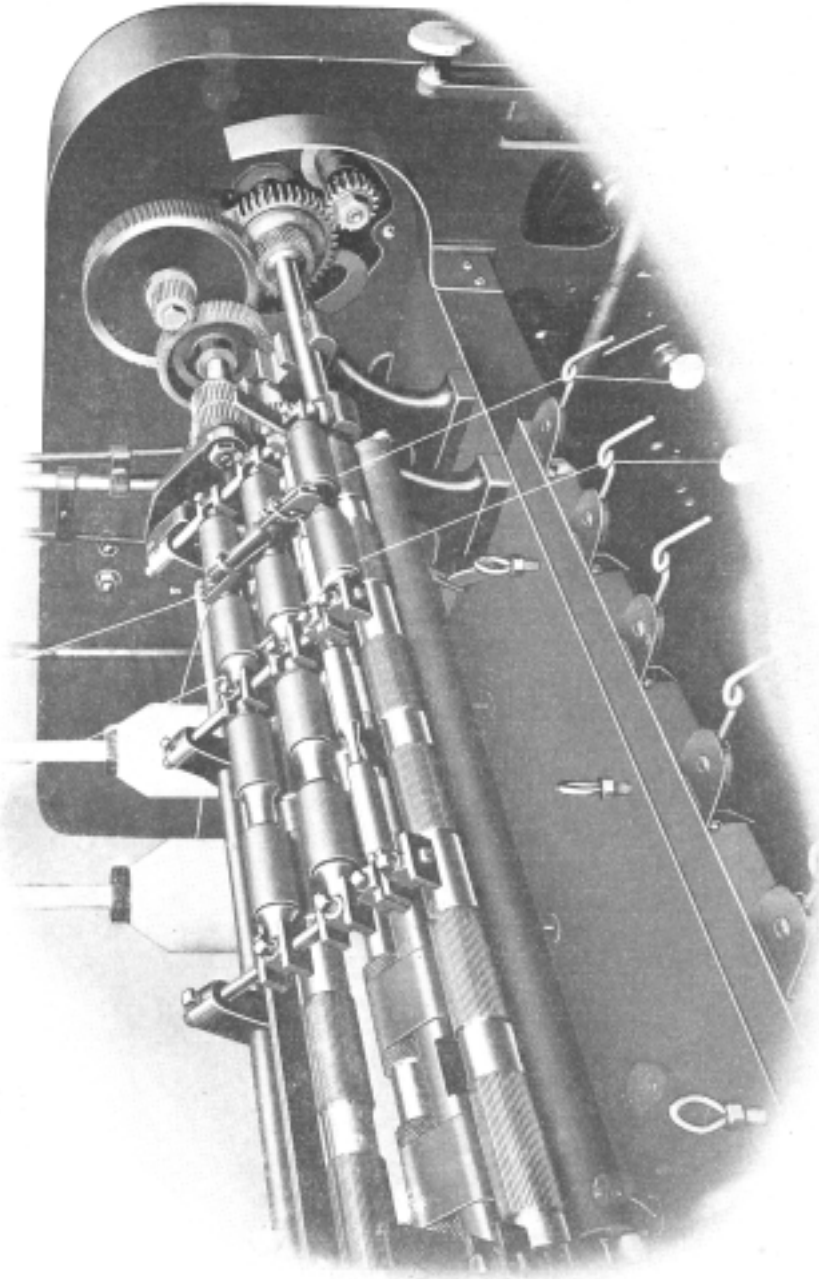

Diagram showing principle of the roll and belt system of Saco-Lowell Long Draft Spinning.

When the function of the top middle roll is analyzed, it is clear that this roll is expected to perform two separate and distinct duties. The first is to unlock the fibres from the binding effect of the twist and start an action of drawing upon the individual fibres. This break draft requires the top rolls to be heavily weight-



Saco-Lowell Long Draft System  
(Le Blan-Roth Patent)

ed to give a positive drawing of the twisted roving. The second duty is to control the regularity of the feeding of the fibres, both long and short, in their orderly turn to the front rolls. The short fibres should be fed to the front rolls, while the longer fibres which are being drawn by the front rolls must be allowed to slip under the middle top roll. The slip draft, then, demands that the middle top roll be light enough to permit the long fibres to slip under it without damage. These two conflicting duties demand that the roll be both heavy and light at the same time. Such a thing, of course, is impossible, so the obvious solution is to have two lines of middle rolls, the back middle being weighted to have a positive hold, the front line being small in diameter, set close to the front roll, and having a light top roll unweighted, permitting slip draft.

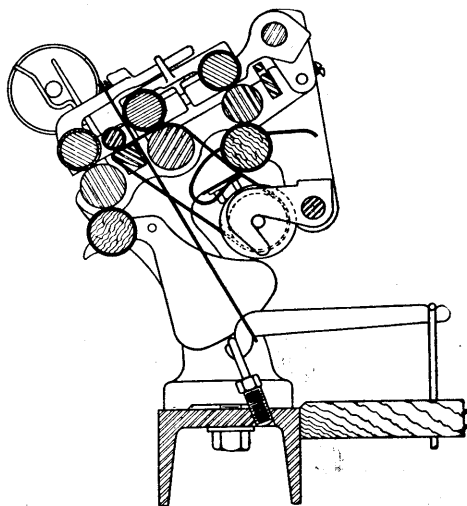

Cross-section of the drawing mechanism of the Saco-Lowell Spinning Frame, showing adaptation of the long draft principle shown on previous page.

This Four-Roll theory is the basis of our present Le Blan-Roth System of better drafting, which we firmly believe marks the highest point yet attained in the evolution of drafting apparatus for Spinning Frames.

The accompanying drawing shows the cross section of our System, from which will be noted that a single endless belt passes over the middle roll and is carried close to the front roll by a bar. This belt takes the place of a small front middle roll, as would be used in an ordinary Four-Roll System, and carries the fibres closer to the front roll, but avoids the evils inherent in a steel roll of too small a diameter. The fibres are held in frictional contact with the belt by a small top roll between the middle and front rolls. This system carries the fibres and delivers them at a point closer to the front roll than any other system. In addition to this feeding, or drawing element, is included the essential break draft equipment of properly adjusted and geared back and middle rolls.

We have maintained for several years a Long Draft Laboratory, the equipment of which is, for the purpose, probably unequalled. In this laboratory, and in mill operation, our engineers have conducted a long series of experiments supplemented by thorough investigations of the whole subject in this country and in Europe, and we find that this system gives the best results of any that have come under our observation.

This system combines with its effectiveness, extreme simplicity in adjustment and operation. It has only three lines of bottom rolls, although it comprises the principles of the Four-Roll

Frame. It has but a single belt, which is held at a light and constant tension by a self-weighted take-up roll at the back of the roll stand. The belt is driven by the action of the middle roll, with which it is held in contact by the weighted top roll. It passes loosely over the bar back of the front rolls and thence to the take-up roll and then back to the middle roll. It will be seen that the point where the belt passes over the bar is at its point of least resistance, thereby giving extremely long life to the belt. If it should be necessary to replace a belt, it may be done while the Frame is in operation. With a single belt such as is used on this system, it is possible to provide it with an effective but simple clearer which prevents the accumulation of fly. The accumulation of fly has been one of the chief obstacles to the successful operation of a belt drawing mechanism.

Unfortunately, when Long Draft was first introduced, some of its sponsors, in order to commercialize the device, made extreme claims and installed equipment to operate under conditions that were not always practical. We realized this from the start, and all of our experiments were based upon this theory, that if we could not produce with Long Draft a yarn equal or superior to that produced by present-day methods of Spinning,

there was no field for Long Draft in this country. There is no magic whatever in Long Draft Spinning. If a certain number of doublings are necessary in a certain mill under ordinary conditions to obtain the quality of yarn they require, the same number of doublings are just as essential with Long Draft, and even more so because of the increased draft in many cases. It should be recognized, that a little more cleaning is necessary, particularly with carded work on the Long Draft Systems, because there are a few more parts that have to be cleaned from lint and fly. Spinners, however, have more time for cleaning, as we consistently find less ends down and furthermore the creeling is considerably reduced in a majority of cases. No mill would think of throwing out the humidifiers because the pipes collect lint and fly and require periodical cleaning. They are content to clean these pipes as often as necessary, because experience has taught them that humidifiers are a real necessity.

---

In conclusion we have no hesitancy whatever in stating that we are convinced that we are working along the right lines and that we have a system of spinning that is of real value to any mill interested in producing better and stronger yarn at lower costs.

---



## Large Package Spinning Frame

ON the finer counts of yarn, the size of the package produced by the modern ring spinning frame is fairly consistent with the limitations involved. On the coarser counts however (20's and under) the size of the finished bobbin rarely approaches its possibilities.

The economies effected by spinning on as large a package as possible have always been common knowledge. The usual limitations have been: first, the ballooning and resultant strain on the yarn from too long a traverse; and, secondly, the excessive speed of the traveler when using too large a ring. Of course, both these limitations may be overcome by slower spindle speeds, but then the advantages of the larger packages are more than offset by the loss in production.

We have recently built a number of frames to specifications calling for extremely large packages for the coarser counts. They have been used with excellent results. The general process of re-designing and improving our ring frame over a period of years, has enabled us to accomplish this.

By the use of ball bearings, accurately cut gears, smooth-running spindles, well balanced ring rail with rigid free running lifter rods, and other refinements, we have cut down the power consumption to a large extent. The result has been that large packages no longer are impractical from the standpoint of power re-

quirements. Furthermore, the rigidity of the frame has been constantly increased by a more judicious distribution of weight and the use of steel beams.

In addition to these general improvements, we have developed a traversing thread board of much simpler construction and greater effectiveness than those formerly available. By its application the ballooning effect on the yarn was greatly reduced and the strain on the yarn at the top and bottom of the traverse was greatly lessened. Coincident with this, the great improvements made in rings and travelers during recent years permit the necessary high traveler speeds.

Specifications of the frame producing the large bobbin are as follows:

Number of yarn . . .	7's from 1 hank roving single
Gauge of frame . . .	4 $\frac{1}{2}$ "
Traverse . . . . .	9"
Ring . . . . .	3"
Amount of yarn on finished bobbin . . .	13 ounces
Time of doff . . . . .	3 times in two days, approximately every 6 $\frac{1}{2}$ hours
R.P.M. on front roll . . .	174
R.P.M. Spindles . . .	6450
Power required . . .	10 H.P. for 200 spindles

Mills using this machine inform us that there are less ends down than on their old spinning frames using smaller packages, and because of the large package free from knots, the spooler hands are able to attend more machines.

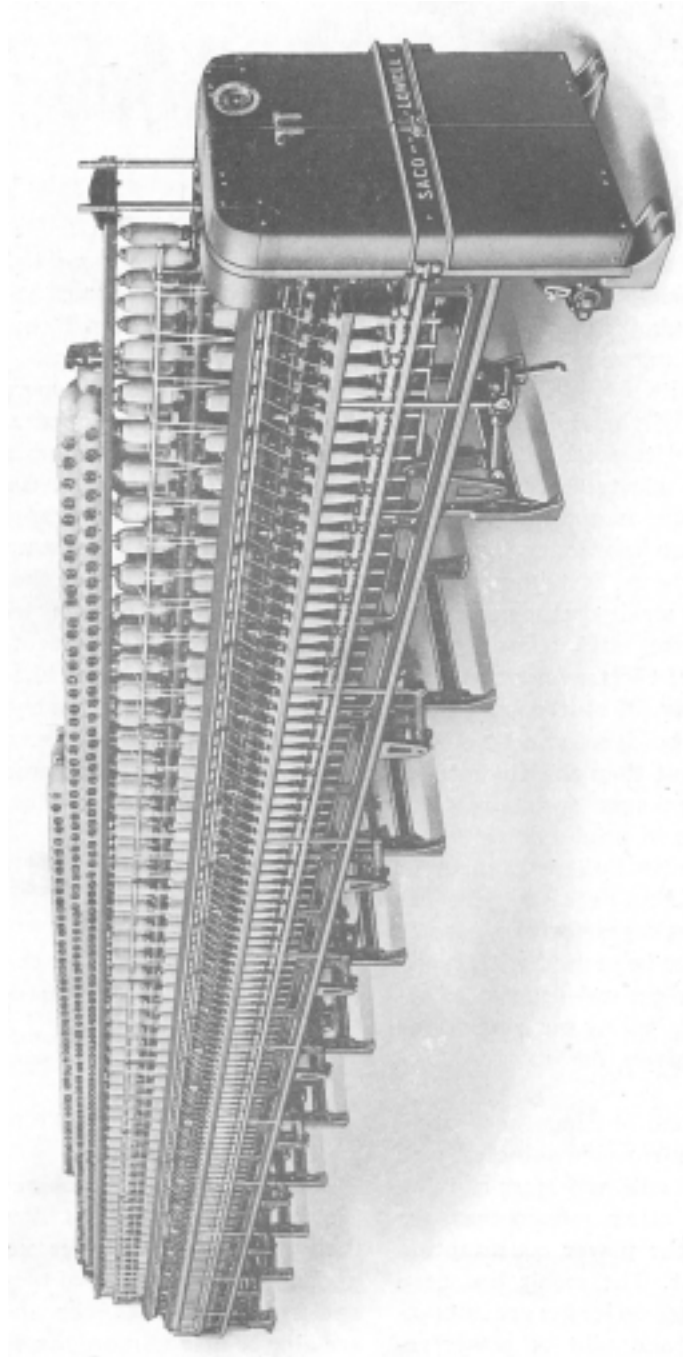

Saco-Lowell Spinning Frame

# Saco-Lowell Spinning Frame

*Many New Improvements in Our  
Regular Frames*

ON display at the Greenville show, we will also have one of our regular Spinning Frames. We have made many improvements in the design and construction of our frame in the past few years, and we sincerely believe it to be the most up-to-date, efficient, and well-made frame obtainable. Our engineers are constantly endeavoring to make our Spinning Frame cheaper and easier to operate, to improve the quality of yarn produced, to increase its production, and cut down maintenance cost. It is the accumulation of many small features that accomplishes this result.

We wish to call attention to the steel beams and spindle rails; the high roll stand which decreases the angle at the thread guide and thus reduces the strain on the yarn at this point; the spiral cut gears; the ball bearing equipped cylinders with Alemite lubrication; the ease of oiling the whole frame through extended oil tubes; the close-fitting milled ring rails which eliminate vibration and keep the spindle centered; the easy running rigid lifter rods with non-binding large bearings; the screw jointed front rolls which work tighter with use instead of loosening up as happens with the old square joint; the improved tape tension which

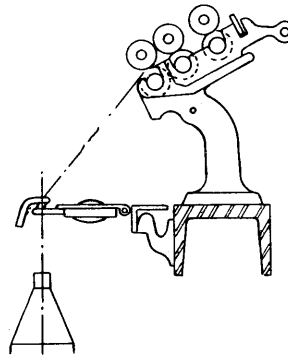

Old Style Roll Stand. 50° angle between thread guide and yarn.

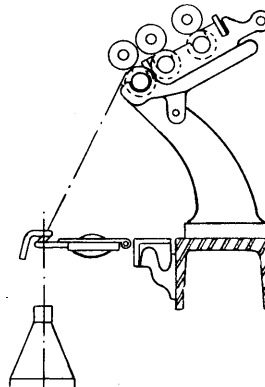

New Style High Roll Stand. 68° angle between thread guide and yarn.



Screw Jointed Roll

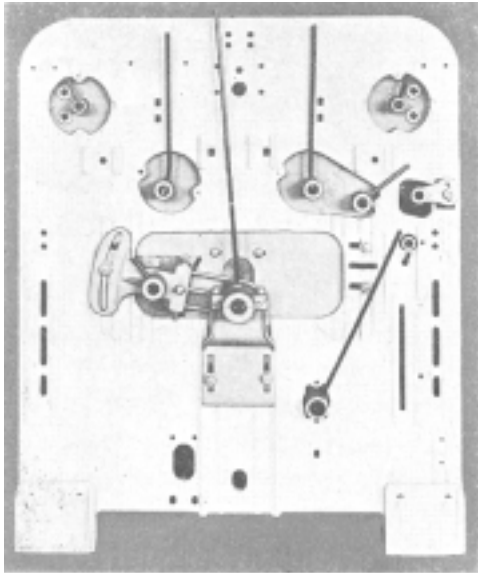

Head End of Saco-Lowell Spinning Frame showing oil tubes which lead to all bearings.

ensures a uniform twist; and many other refinements you cannot fail to notice.

This frame will also be equipped with the S.K.F. Roller Bearing Spindle which has met with exceptionally successful results. They reduce power, especially at

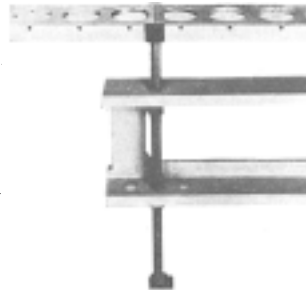

Ring Rail application.

Ball Bearings applied to cylinder.



starting, need but infrequent oiling, run exceptionally smooth, and are long lived.

We are confident that every mill man at the Greenville show will agree that this Spinning Frame is the finest obtainable.

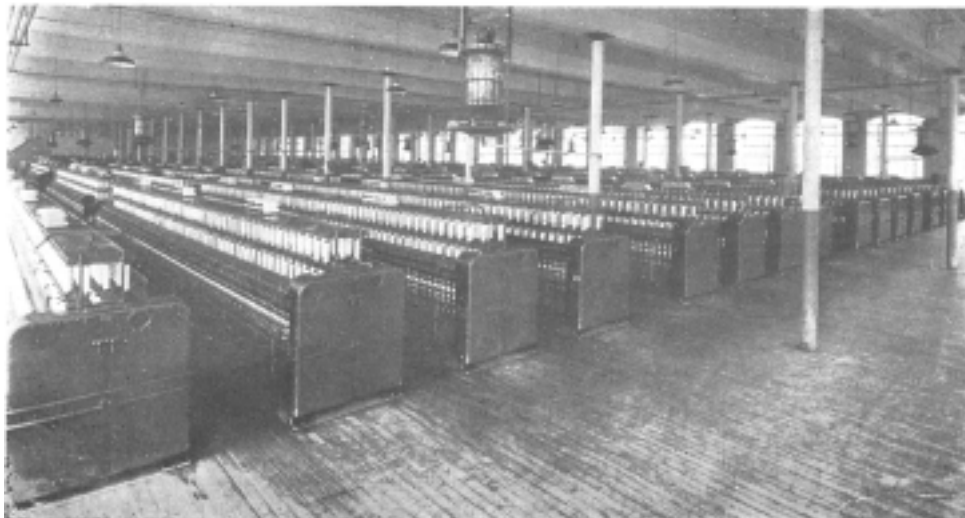

---

## Saco-Lowell High Speed Twister

**T**HE Saco-Lowell High Speed Twister is the result of three important developments—the High Speed Oil Retaining Ring, the High Speed Ball and Socket Spindle, and the High Speed Separator. These overcame the three elements which had previously limited the speed of twisting, namely, vibration of spindle at high speeds, overheating and burning off of traveler, and the strain and wear on the yarn due to the old type separator.

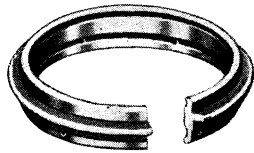

High Speed Twister Ring.

The High Speed Ring is oil retaining, having two grooves on the inside with small holes leading from the bottom groove through to the lower back part of the ring so as to lubricate the heel of the traveler. The grease fills the top groove when the operator greases the ring in the usual way. This grease melts as the ring and traveler warm up under operation and the grease, slowly melting, trickles down over the ring into the second groove and through the small holes. The grooves act as a sort of reservoir for the grease and the action of the traveler

keeps a sufficient amount on the working surface of the ring. This ring is capable of exceptionally high traveler speeds and cannot be compared with the old type.

We found also that in order to further increase the efficiency of this High Speed Ring it was necessary to have a traveler of the proper analysis. It is also equally important that the lubricant be exactly right. We experimented for seven months with eighty different kinds of lubricating compounds—the best the market afforded—and finally found the compound that gave the best results. The result is that the use of the Saco-Lowell High Speed Ring with a traveler of the proper bronze analysis, together with the special high speed grease, enables the user to operate at a very exceptional increase in speed.

After getting satisfactory results with the ring and traveler, we found that the ordinary spindle would vibrate at the increased speeds, so much that it was impracticable. We then started on experimental work for a spindle. This lasted over a year and resulted in the production of what is now known as the Saco-Lowell High Speed Spindle. The construction of this spindle is a radical departure from anything in the past. The vibration is absorbed by a spring which really acts as

---

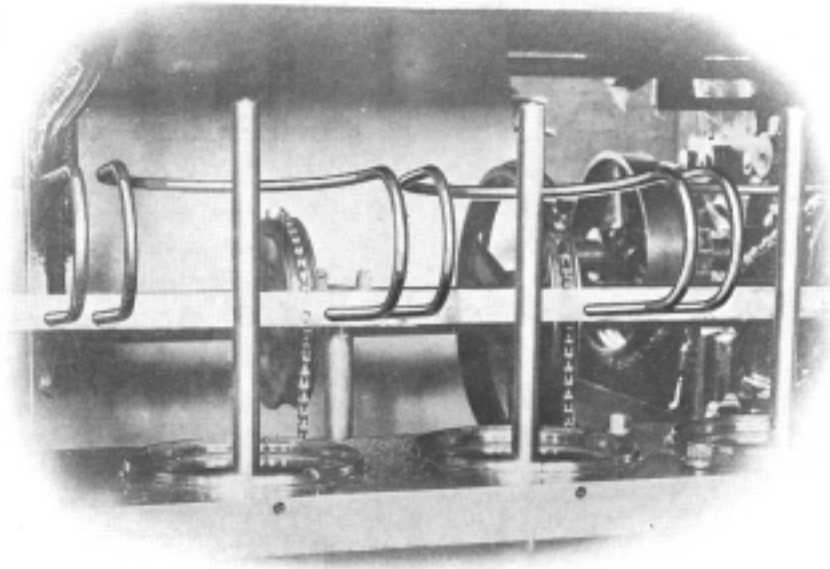

High Speed Separators.

the shock absorber and causes the spindle to find its center of gravity. The result is that the faster it runs the more perfect it operates. We have never found any limit to the speed of the spindle. It is constructed in a way that provides ideal lubrication. The bearings are a special bronze, some of which have been in operation over three years without any apparent wear or trouble. The bolster is suspended in the base with a spherical seat at the top of the base. A rounded portion on the bolster makes it operate like a ball and socket joint so that it is free to gyrate. When running, it operates exactly on the principle of a top.

With the old type separator the ballooning effect of the yarn was controlled, but this was done at the expense of a great deal of wear if the speeds were excessive. A flat separator being on each side of the spindle, the yarn hit, with considerable force, a hard flat surface twice in each revolution with consequent chafing and wear. Our new type of separator is of U-shape construction, being one continuous bar of smooth steel forming a semi-circular arc behind the spindle. The yarn thus follows this separator for more than half its circumference, controlling the ballooning effect and at the same time reduces to a minimum the usual

---

Saco-Lowell High Speed  
Twister Spindle.

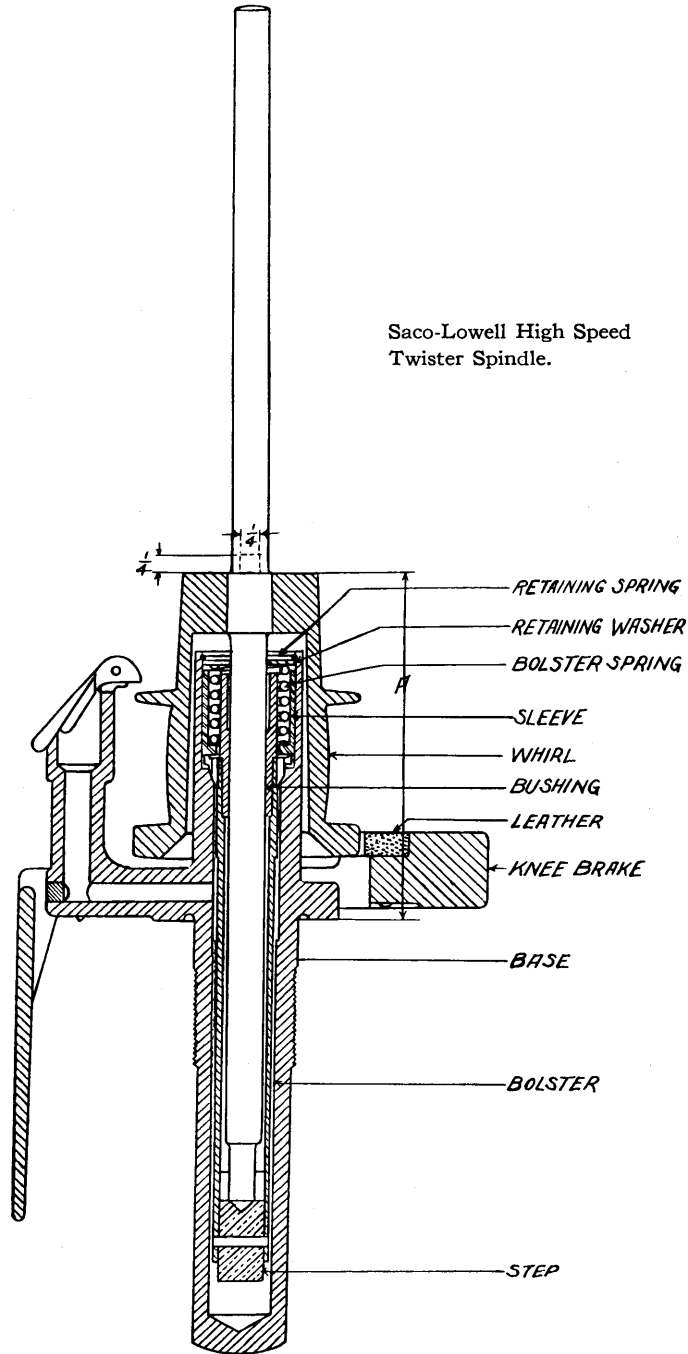

wear on the yarn, as there are no hard blows against a flat blade as formerly. This separator can either be fixed to the ring rail or be of the traversing type; the latter is of course preferable.

After we had overcome the difficulties of the ring, traveler, spindle, and separator, we then found that the pronounced increase in speed required the adoption of more rugged parts throughout the frame. We accordingly increased the rigidity of the tin cylinder, at the same time decreasing the maximum length of any section so that today we do not make

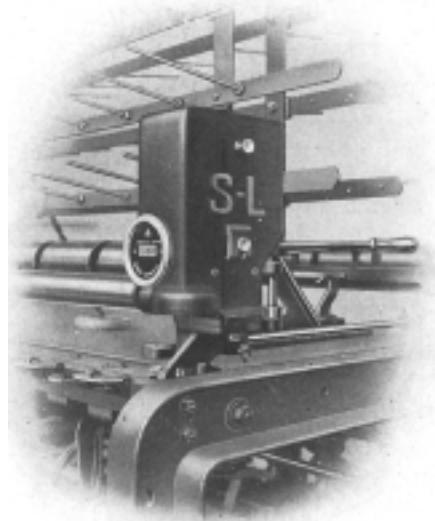

Combination Hank Clock and Knock Off.

any longer than 9 feet. The thickness of the material was increased with the result that we have, in the experimental tests, applied as much as 127 horsepower

to this cylinder without any deflection, vibration or damage.

We have adopted steel top rolls, in the place of the old cast iron, as they are smoother and harder. The bottom rolls are ground accurately to size. The gears that operate at high speeds are spiral to eliminate noise. We recommend the use of annular ball bearings for all cylinders, and, where individual motor drive is specified, we strongly recommend the use of an electrical starting device that will bring the speed up gradually. We also advise the use of a cylinder brake, as the frame operating at such high speeds requires too long a time to stop after the power is cut off. The comparison is 25 seconds without the brake to 8 seconds with a brake.

We can also supply with these twist-ers, a combination of a standard 100-yard Hank Clock and a measuring knock-off motion which can be arranged to stop the frame at the end of a given number of yards delivered by the front roll. The range covered by the knock-off motion is from 300 to 10,400 yards.

We are operating these High Speed Spindles on tire work at the following speeds:

5½" ring over 3,000 R.P.M.

4½" ring " 4,000 R.P.M.

3½" ring " 5,000 R.P.M.

On light yarns such as 2 ply 50s, we are operating 3" rings up to 7,000 R.P.M.

We have sold in excess of 100,000 spindles of this high speed equipment since the first of April 1923. Our customers,



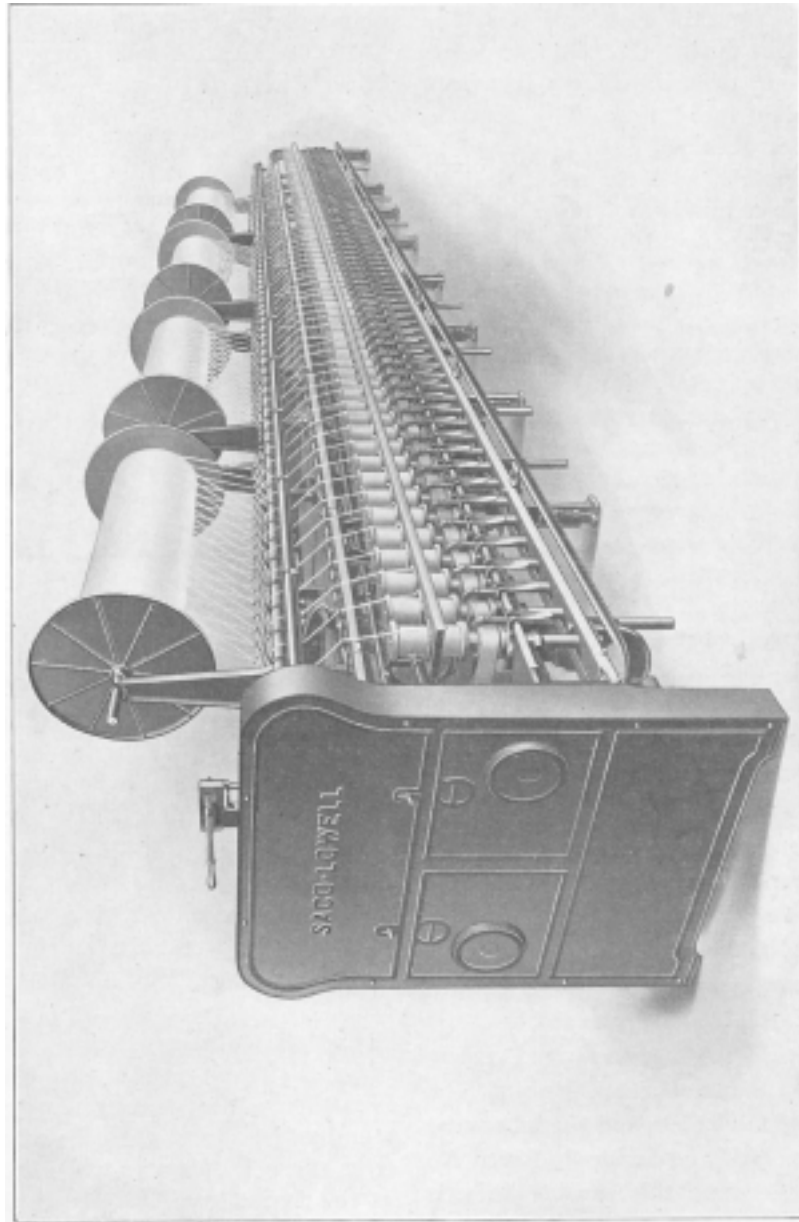

Saco-Lowell High Speed Beam Twister.

realizing from experience the advantages, find that they cannot afford to operate the old slow speed twisters. The result is that during the past two years most of our twister business has been on the high speed type. The remarkable results obtained quickly spread to foreign countries with the result that we have made a number of large installations in Germany, Italy, France and Spain.

We have made a great many tests for power consumption and find that the high speed spindle requires less power at the same speeds than any other type, not even excepting the ball bearing spindle. However, as the speed is materially increased the windage of the yarn requires more power, of course, than for the slow speed. The quality of the yarn produced on this machine is in all cases the equal, and in many cases superior, to that which the mills are making with their old machines. This is especially true of tire yarn where we find a higher breaking strength and a higher percentage of elongation.

When building a new mill, floor space required for a given output will be from 60% to 70% with the new Twister against 100% for the old, thereby resulting in a considerable saving and cost of buildings. The cost of power consumption will be slightly increased per Twister, but not per pound of cotton doubled. The investment will be less and the labor cost for operating will be decidedly lower. An important item in this consideration is the bobbin cost. We had one case recently where the installation of High Speed

Twisters reduced the cost of bobbins for the mill (to produce a certain number of pounds per week) from \$2500.00 to \$1500.00 and this only covered 8 High Speed Twisters. In other words, a saving of about \$125.00 per frame, due to the smaller number of bobbins required and the larger package made.

Considering all costs of buildings, equipment, power consumption, bobbin, labor, etc., we have shown a net saving to the mill in the cost of twisting cotton of about 20% to 25%.

## Saco-Lowell Standard Fine Twister

OUR regular light Twister is built upon our standard Spinning Frame chassis, the only difference being above the roller beam and the spindle. This Twister has therefore all the advantages of our Spinning Frame as outlined on page 17.

The Twister on exhibit at the show is equipped for wet twist and we wish to call your attention to the simplified method of mounting the water pan and the revolving brass rod therein which reduces the strain on the yarn. This strain is further reduced by our new type of roll stand which places the rolls more nearly over the spindles with very little angle at the thread guide. We have also developed for this frame a new spindle and brake especially designed for high speeds.

---

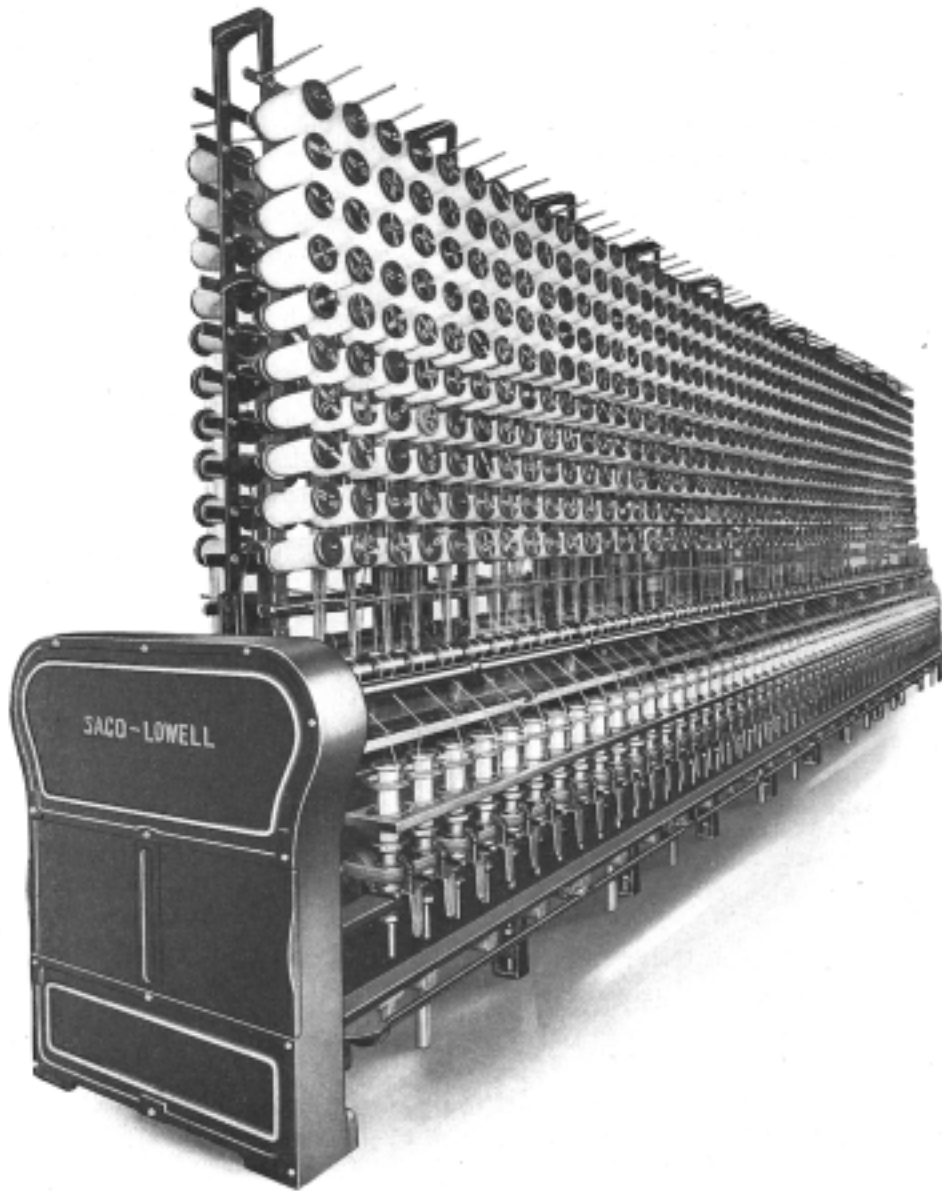

High Speed Twister.

## Saco=Lowell High Speed Warper

**M**ANY mills are now effecting substantial economies by using our High Speed Warper in conjunction with cone winders, as the Warper draws from stationary cones a great increase in speed, and, consequently, production can be gained.

Our Warper, which is especially designed for high speeds (averaging between 300 to 400 yards per minute), is of especially rugged construction and is unusually smooth running. The following gives a brief description of the mechanical construction of this machine.

### **Construction:**

The standard High Speed Warper is made to take beams 54", 54 $\frac{1}{4}$ ", or 54 $\frac{1}{2}$ " between heads. Wider machines can be furnished to meet special requirements. It is of unusually rigid construction to stand high speed without vibration. It is accurately machined all over so that parts are interchangeable.

### **Cylinder:**

The cylinder is 15 $\frac{1}{4}$ " diameter and has spiral gear drive. Will take beams up to 30" diameter with 10" barrel and 54 $\frac{1}{2}$ " between heads. Cylinder is mounted on a shaft which runs in ball bearings.

### **Cylinder Brake:**

To prevent the over-running of the beam when an end breaks, the cylinder is equipped with a Toggle-operated, internal expanding, two-piece brake, lined with asbestos brake lining. The construction is similar to the usual automobile brake.

It can be set to stop the cylinder within one-half to three-quarters of a revolution.

### **Winding Pressure:**

The beam rotates in brass bushings which are put on the beam dunnage before the beam is placed in position on the warper. The bushings rest on shoes which support the beam. The shoes in turn rest on the arms of beam quadrants on which they are free to slide as the beam fills. The quadrants are pivotally mounted on arbors carried in the warper sides. The beam weighting is arranged to give a constant pressure during the entire winding, which gives a greater and more even density to the beam.

Dogging arrangement is also applied; the object is to prevent excessive pressure of the beam on cylinder. This results in the winding of a more concentric beam.

### **Combs:**

The usual spring or positive expansion type of combs are furnished for the front of the warper. A spring comb with long dents is furnished for the rear.

### **Carrier Rolls:**

All carrier rolls are solid cold rolled steel, accurately ground. They rotate in ball bearings, thus reducing the strain on the yarn to a minimum. There are glass rods directly in front and in back of the rear comb.

### **Measuring Device:**

Measurement is made directly from the cylinder instead of from a measuring roll as heretofore, thereby eliminating slippage and insuring more accurate results.

### **Stop Motion:**

The warper is equipped with a mechanical loom stop motion. An electric stop motion can be sup-

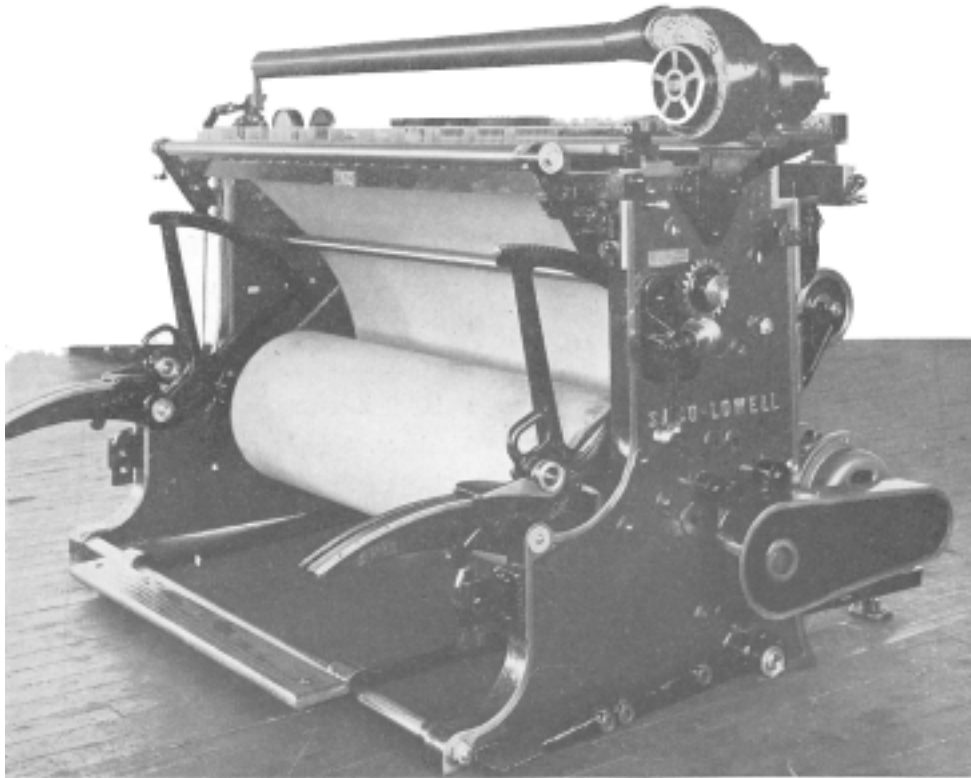

Saco-Lowell High Speed Warper.

plied, if desired. There is one bank of drop wires made of coppered sheet metal with highly polished edges where it touches the yarn.

#### **Blower:**

A blower with motor attached is mounted on the drive end of the warper. It blows air at a high velocity through a 3" tube with a number of slots on the under sides. The tube is held longitudinally over the drop wires, and oscillates at such an angle as to keep clean the front and rear combs and the drop wires. The blower motor is wired for lighting current.

#### **Production:**

Mills are known to run the warper at 410 yards per minute. It may be run faster if found practi-

cal. Naturally, for a high speed, an over-end draw package in the creel is essential.

#### **Drive:**

The warper can be furnished for belt drive or with individual motor drive having chain or tex-rope. In the latter case, a 1½ H.P. Squirrel Cage or Adjustable Speed Motor is furnished.

This method of warping effects many economies at every stage of proceedings. A magazine creel is usually used behind our High Speed Warper. This creel is built in such a way that two cones are placed on in such a manner that the end

from either will run true to the same guide or tension. First a cone is placed in position and threaded, leaving the end on the inside of cone (which has been left long on winder) hanging. Another cone is then put in the creel and the outside end of yarn is tied to the inside end of first cone. When the first cone is empty the second one automatically starts to feed. Then the creeling hand takes off the empty cone and puts in another full one and the operation already described is repeated. The result is that you creel continuously and never stop the warper for any creeling. As the cones are emptied every time and returned to the winders, there is no carrying of dead yarn, as is the case with the old type warper using a revolving spool creel.

Inasmuch as the warper draws from

stationary cones, the tension is less and is absolutely uniform at all times. Such uniformity of tension can never be accomplished when drawing from revolving spools. The percentage of slack ends is therefore reduced to a minimum. The section beams made from these High Speed Warpers are consistently better than those made on the old system. We know of many cases where there has been a 10% increase of production on the Slashers, there being much less waste owing to the uniformity of yardage and delivery. The percentage of loom stoppages, in using beams made from the High Speed Warper, is consistently lower. We have recently had reports of 5% added efficiency to looms running from this High Speed System.

---



*The*  
**SACO-LOWELL**  
*Organization*

offers valuable experience to its customers. Specializing in machine operation, the members of this organization have had an unlimited variety of mill problems to face. On the strength of their accomplishment, the Saco-Lowell Shops have grown, developing many products that are now standard in the industry.

We offer a complete line of cotton spinning machinery, each unit of which is a standard in its field.

■

