

VOLUME II NUMBER 1 JANUARY 1937

THE WEAVER

PRICE 25c

THE WEAVER

VOLUME II NUMBER I

C O N T E N T S

Interesting Ways to Use "Laid-in" Technique page 4
Nellie Sargent Johnson

Interesting Developments on the "Rosengang" page 8
Esther Hoagland Gallup

Questions and Answers page 11
Mary M. Atwater

The Weavings of Loja Saarinen page 13
Florence Davies

Baby Blankets page 18
Veva Carr

Scandinavian Art Weaving page 20
Elmer Wallace Hickman

"Stunting" on the Cards page 25
Mary M. Atwater

The Weaver, published quarterly in months January, April, July and October by Emile Bernat & Sons Co. Published at 10 Ferry St., Concord, N. H. Editorial offices, 89 Bickford St., Jamaica Plain, Mass. Price, \$1.00 per year. Entered as second class matter July 29, 1936, at the Post Office at Concord, N. H. under the Act of March 3, 1879.

*Copyright 1937 by
Emile Bernat & Sons Co.*

Interesting Ways to Use "Laid-in" Technique

BY NELLIE SARGENT JOHNSON

Special Instructor in Weaving at Wayne University, Detroit, Mich.

THERE are two large general classifications of hand-woven fabrics with regard to their pattern design. One which can be called the free-weaving techniques, and the other loom-controlled pattern. The free-weaving techniques include all types of weaving where the pattern design of the cloth is controlled entirely by the hands of the weaver, while loom-controlled pattern is dependent on the method used in the pattern threading of the loom. In the free-weaving techniques we have all forms of tapestry weaving, rug knots and pile techniques in their different variations, so-called embroidery weaving, Spanish stitch, laid-in technique, etc. The only requirement of these techniques is the ability to make a simple two-harness shed on the loom used. But the ultimate success of the fabric itself is much more dependent

on the skill of the weaver himself, and his knowledge and application of the principles of design and color in these free-weaving techniques, than it is in a pattern design which is controlled by the mechanical manipulation of the harnesses of a loom.

One of the simplest of the free-weaving techniques is the so-called "laid-in" method of decorating the web of the cloth while it is on the loom. It allows for much freedom of design, and is not nearly as slow to do as tapestry or some of the other free-weaving techniques. It may be woven on any loom which will give the plain weave. Some of my students have used it successfully even on a simple card-board loom for a bag or purse.

Any type of thread or yarn desired can be used for this type of weaving. There is only one general principle which it is well to remember with regard to your choice of materials, and this is that the effect is generally better if the colored pattern thread of the design being "laid-in" is somewhat coarser than the plain weave or "ground" of the fabric. Also the weaving should be more closely beaten up with the batten in the parts where the design is being put in, because the coarser pattern thread of the laid-in design will have a tendency to make a more open texture where the pattern is than in the plain weaving on the fabric.

At Illustration No. 1 is shown an example of the "Hit and Miss" laid-in technique, which may be used either as a table runner or an effective wall hanging. This was woven on Bernat's gold silk warp set 24 threads to the inch, with Bernat's tapestry wools in shades of red, with the plain weave background in two shades of Fabri yarn used together. Several shades of blue and blue-green tapestry yarn instead of the reds, or any other combination desired can be used. With this "Hit and Miss" technique, all sorts of odd yarns may be used together also. In this weaving no definite design is drawn out, but the pattern is carried out right with the threads as you weave. So it is possible to put in any design or color you feel like using. And here is a splendid opportunity to use your skill and ingenuity to obtain rhythmic flow and balance in such a piece of weaving. And you may be very sure, too, that no one will be able to exactly "copy" that particular piece of your weaving.

At Figure No. 1 is shown the graphic detail of the "Hit and Miss" method of weaving laid-in technique. This and the following description of the exact method of doing this technique was taken from the April 1936 issue of my monthly leaflet "Handweaving News": "Weave a heading of plain weave for the number of inches desired, and then start your colored threads as at 1 and 2 of Figure No. 1 detail drawing. One important point to remember, especially if you are using several colors, is to be sure and have

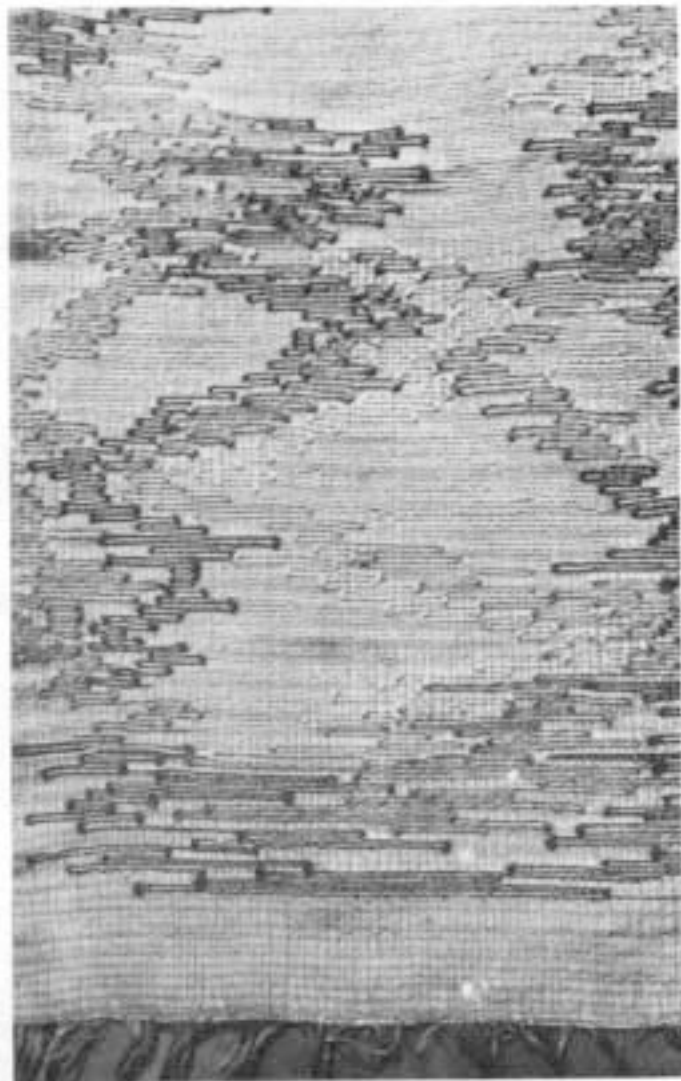

Illustration No. 1

all of your colored threads going in the same direction as your thread of the plain weave or tabby thread. Throw a shot of plain weave tabby from left to right, then in the *same* open shed lay in a thread of rose color as at 1, from left to right. Leave a space of several warp threads and lay in a second thread of green as at 2 of Figure No. 1, also from left to right. These two threads can be left to lie on top of the warp threads, or pushed below the warp threads as desired. Now change the plain weave shed, and throw a shot of the plain weave tabby from right to left all across the width of the warp threads. In this same shed, lock the rose thread around a warp thread to fasten it, and carry it also from right to left for any distance you wish, or to within a few warp threads of the green thread previously laid-in. Then lock the green thread around a warp thread and carry it from right to left for any distance you wish. The ends of the colors with which you began may be cut off after the weaving has progressed a short distance, and they are well beaten into the fabric. To finish a color, lock the thread around a warp thread, and carry it back in the same shed. Beat up well and cut off the end after the plain weave is well beaten up."

After you have woven the "Hit and Miss" laid-in technique, you may wish to try your hand at designing some simple squares which can be used for modern linens with a very excellent effect. At Illustration No. 2 is a photograph of a heavy linen runner of a luncheon set. This was woven on a warp of 15/4 linen set at 12 threads to the inch, with the squares "laid-in" with Bernat's real silk. The plain weave tabby was the same as the warp thread, 15/4 linen. The method of working the squares is shown in detail at

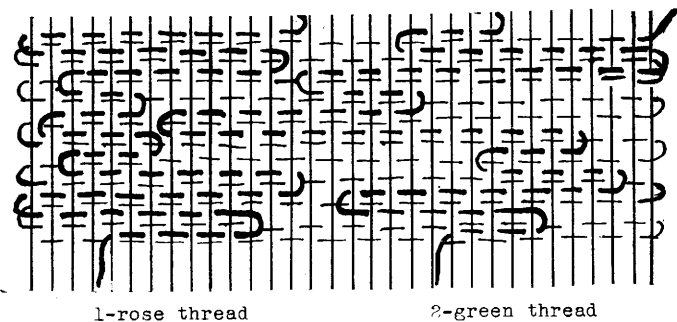

Figure No. 1
Detail of "Hit and Miss" Laid-in Technique

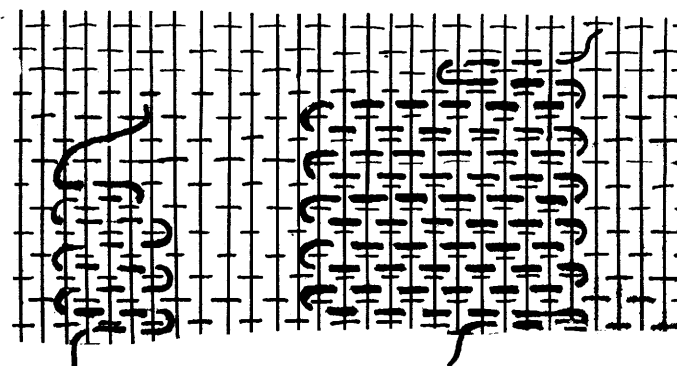

Figure No. 2
Detail of weaving squares in Laid-in Technique

Figure No. 2, also taken from my "Handweaving News" of April 1936. The method of working is exactly the same as in the "Hit and Miss" method, except that the design is kept to a definite figure, and not put in entirely as fancy dictates as you work on the loom. The pattern design of squares which you are following may be drawn out the actual size it is to be woven and pinned underneath the warp threads, or the warp threads may be counted for the necessary distances required for the laid-in squares. The plain weave thread of Figure No. 2 is represented by the fine line between the heavy lines of the colored pattern thread, and shows very clearly how to start and end the colored pattern threads, as well as exactly how the definite square is woven in.

Illustration No. 3 is a small wall panel woven of Bernat's 40/2 linen warp natural, with plain weave tabby of the same material. The colored pattern was laid-in with Bernat's heavy linen floss in tan, blue, rose, violet, yellow and green. The design is a tulip design based on the method of designing with the square as a unit. The photograph does not do this little piece of weaving justice, as the use of the different colors was very good indeed. This was woven by

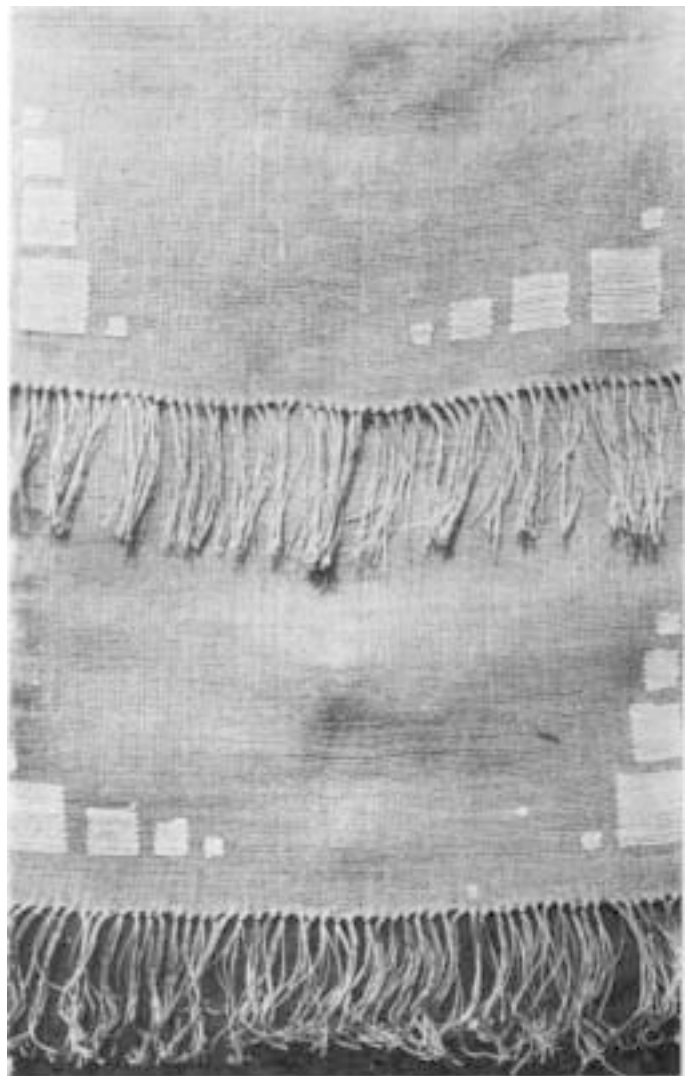

Illustration No. 2

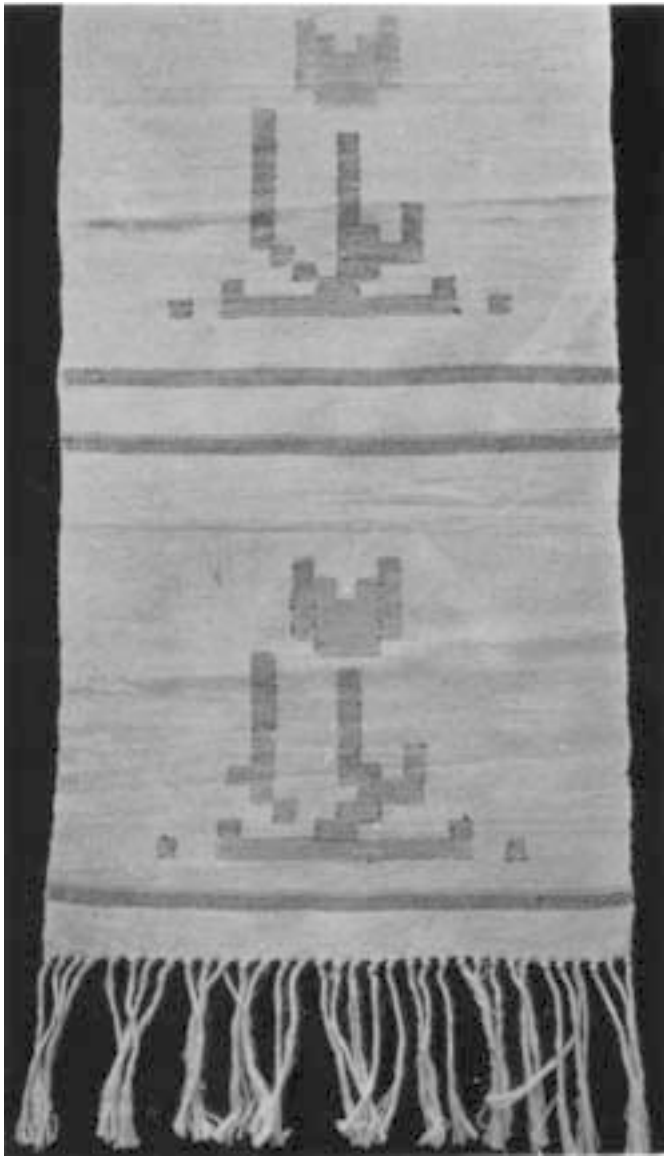

Illustration No. 3

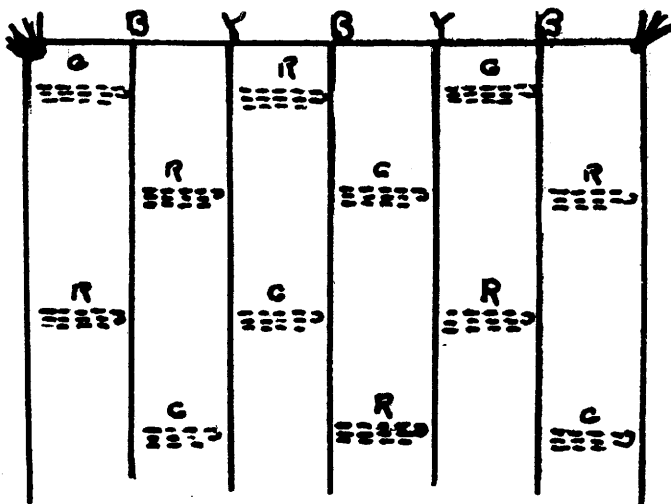

Figure No. 3

Detail showing arrangement of warp stripe colors and laid-in pattern design of Illustration No. 3

Mrs. Florence Anderson, one of the students in my class in creative weaving at Wayne University last spring, and was her first attempt at this type of weaving.

Illustration No. 4 is the centerpiece runner of a linen luncheon set woven by Mrs. Schlater of Madison, Wis. Mrs. Schlater designed this to be used with her handmade pewter dishes, which she also made herself. It was woven of No. 14 grey linen set at 20 threads to the inch. The small drawing at Figure No. 3 shows how the colors were placed in the warp, and with the pattern weft which was Bernat's heavy linen floss. The lengthwise lines represent three threads of colored warp respectively, blue, yellow, blue, yellow and blue. These lengthwise threads of warp help to space the groups of colored weft threads which were woven of green and red alternately as shown on the drawing at Figure No. 3. The ends were plain-hemmed, and the small tassels of red, yellow, blue and green linen floss were made and fastened to each corner of this runner. The place mats were designed smaller, but followed the same general plan. The whole thing was very simple, but most effective especially with the well made pewter dishes with which the set was used.

Illustration No. 5 is an attractive bag mounted on one of my black bag frames designed especially for this. The warp was of Bernat's real silk set at 30 threads to the inch, with weft of black raw silk for the pattern, and fine black silk for the tabby weave between the pattern shots, and the opposite pattern shots of white silk. This bag was included, as it well illustrates the loom-controlled pattern, as it was woven on an eight-harness loom. But it could have been woven in laid-in technique, although the texture would have been slightly different. It also shows the principle of designing with the square as a unit, but the design could have been more free if it had been woven in laid-in technique.

At Figure No. 4 is a drawing of a simple border which can be used for linen towels. Use 40/2 linen warp and weft, with linen weaver for the inlaid pattern squares which may be woven in any desired colors. A colored hem to match the colors used for the inlaid squares is attractive. The squares may be woven all of one color, or shaded from dark to light. Much variety and interest can be achieved with this simple method of weaving.

Because of the ease with which designs can be created with the square as a unit for this laid-in technique, I am presenting at Figure No. 5 a page of drawings taken from my "Handweaving News" for January 1936, with additional comments as to how these can be used for a woven fabric in laid-in technique. At A is given the drawing of the design used for the linen runner illustrated at No. 2. The unit of

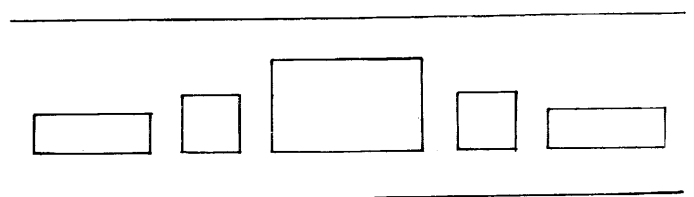

Figure No. 4

Arrangement for Towel Border in Laid-in Technique

this design is the square 1, the other squares being multiples of this in the progression of 1, 4, 9 and 12. You can take whatever size you wish for the dimensions of square No. 1 and make the others in proportion to this. The size of 1 in the woven fabric shown was $\frac{1}{2}$ inch. At B and C of Figure No. 5 are other arrangements using the squares as lines. B is effective when used as in Mrs. Schlater's runner at Illustration No. 4, but space the groups further apart and mark the place where they are to be woven with the lengthwise warp threads. These can be either in color, or black is good for many things. At D and E are two border designs for luncheon sets or linen towels. Fine white linen used for pattern of these squares, used against natural or grey linen for warp and plain tabby, give just enough contrast to be interesting and attractive. When weaving these squares, the threads of the warp can be counted for the sizes of the squares, or the design can be drawn out on paper the exact size it is to be woven, and then pinned underneath the weaving, and the laid-in threads put in according to this. Use either method, whichever is easiest for you. At F is an unusual way to divide up the area of a square. This design may be used as it is, or can be joined in several different ways as a repeat. If you make several tracings of this motif and put them together, you will get the effect of what may be done with it.

These suggestions for designing, with the square as a unit, should add much to make the laid-in technique of interest to you. For a very long time, it has been my contention that most handweavers are perfectly satisfied to copy and copy,

(Continued on page 11)



Illustration No. 4

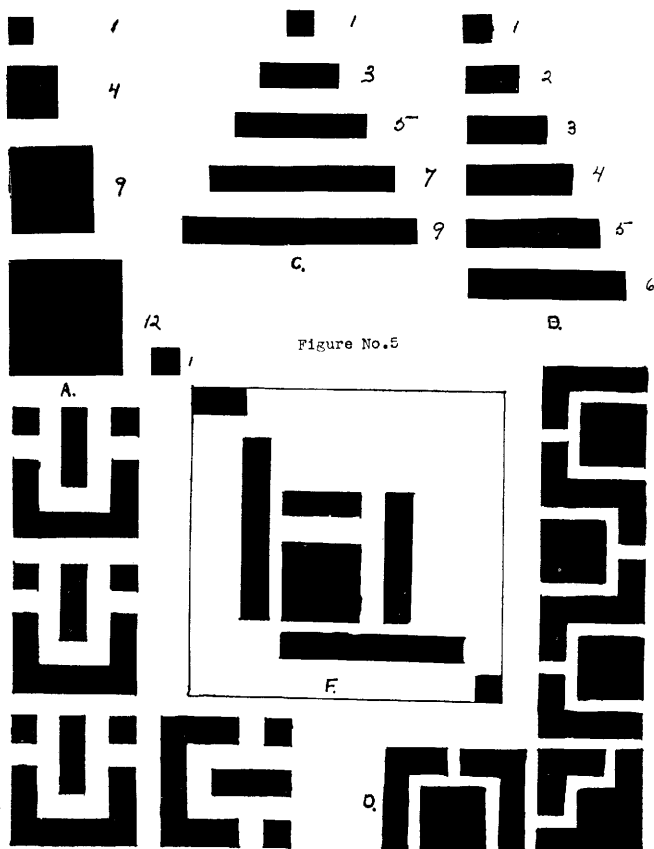

Figure No. 5

Designing with the square as a unit



Illustration No. 5

Interesting Developments on the "Rosengang"

BY ESTHER HOAGLAND GALLUP

IT is my hope to present to readers of *THE WEAVER* a new use of the familiar "Rose-Path" pattern and a new appreciation of its possibilities in creating fine decorative textiles. Its similarity in draft to the straight twill or herringbone threadings, when used in the manner I am about to suggest, makes it structurally satisfactory for hangings, upholstery, couch spreads, or even rugs — all having the firm texture and durability of the Navajo work with a flexibility of design and color at once decorative and suggestive of the traditional. Much of Swedish upholstery and wall hangings, using this threading alone, is developed in an almost endless variety of color and pattern combinations.

A suitable warp for the weave is one of No. 10 mercerized Perle cotton; or a linen yarn of lighter weight may be substituted, although after due consideration to the strength of the material the cotton may prove the better warp from an economical standpoint. The question of beauty does not particularly enter, as the warp is completely covered, but it may be sleyed closely and allowed to show if an extremely tight fabric is desired. This might well be the case in the use of the "Single-Harness" patterns which will be described in another article.

Shall we then assume that our warp is carefully beamed, our heddles threaded to the familiar "Rosengang" pattern, and our reed, which is 10 dents to the inch now sleyed one thread to the dent? Our next consideration must be the weft, a strong, soft wool — preferably a homespun with enough elasticity to enable us to cover our warp threads easily. The writer has seen Swedish textiles woven in this way from handspun and home-dyed wool, which, in spite of the number of shots to the inch and firm beating, felt supple and light to the touch. A six-pedal loom is a convenience (though not a necessity), for *this* weave is done on opposites. Diagram (A) suggests a convenient tie-up and includes the threading for anyone who may not have it at hand.

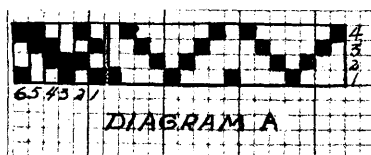

In case a six-pedal loom is not available, the alternative is a simple one. Pedal in each case so as to draw down the harnesses as indicated in the tie-up. For instance, if pedal 3 is given, instead depress the pedals which will draw down the harnesses attached to that pedal (see Diagram A), in this case No. 1 and No. 2, etc. Weave a selvage of plain cloth and follow this by a heavy border done in one color on either of the opposites (for there is little to choose between them). Thus: across on No. 3 and back on No. 5 for several

rows, or across on No. 4 and back on No. 6, for the initial border. This produces a rich band of color, and *raises the level of the weft threads to that maintained throughout the piece.*

Since stripes, large and small, complex and plain are to be the order of our weaving, perhaps a word or two of caution concerning the plan or *design* will not be amiss.

In general, then: Stripes, complex in pattern and in color or in both, should be followed by restful areas of plain colors, usually smaller than the pattern stripe if it has been a wide one, or larger and perhaps redeemed from heaviness by one or two changes of color if the pattern has been a small one. Since rhythm is defined as "changeable movement," we must use a variety of sizes and shapes in order to secure a unified, rhythmical design. A study of the beautiful symmetrical or asymmetrical Roman stripings will always prove helpful.

Color, too, plays an important part in creating rhythm of design. Fortunately, for most of us at least, the very restrictions imposed upon us by our four harnesses and the ensuing limitation of pattern help keep our design unified. But what a breaking up of harmony and sustained interest can be wrought by an unhappy choice of color!

For our designs which follow, a simple color harmony involving three or four values may be sufficient, and two or three of these may be varying shades of the same hue. As an example of this plan a couch cover might be worked out in five values — vanilla, bisque, chocolate, and dark brown — all shades of the same color family, with a little rich rust color added for interest and life.

So, keeping our colors and spacing in mind, we begin our first pattern, Diagram B-I.

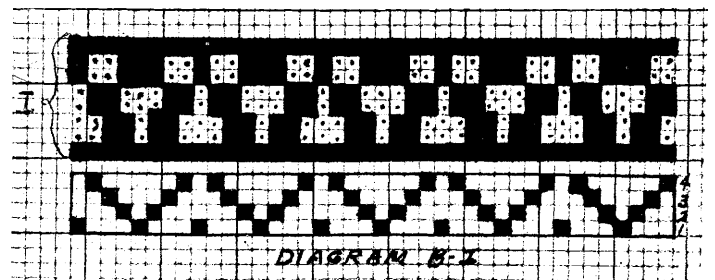

Pedal No. 4 with pattern color followed by No. 6 with background } as many times as seems attractive. This particular design was done four times (or eight picks)

Then:

Pedal No. 5 with pattern color followed by No. 3 with background } twice (or four picks)
Pedal No. 3 with pattern color Pedal No. 5 with background } twice (or four picks)

There follow several designs used in the couch cover sug-

BORDER DESIGNS, DIAGRAM B

No. II

Harnesses

- 1 & 2 } chocolate — 14 picks (xxx)
- 3 & 4 } chocolate — 14 picks (xxx)
- 1 & 2 chocolate } 8 times (or 16 picks)
- 3 & 4 bisque } 8 times (or 16 picks)
- 2 & 3 chocolate } 4 times
- 1 & 4 bisque } 4 times
- 3 & 4 chocolate } 4 times
- 1 & 2 bisque } 4 times
- 1 & 4 chocolate } 6 times (ooo)
- 2 & 3 bisque } 6 times (ooo)
- 3 & 4 chocolate } 4 times
- 1 & 2 bisque } 4 times
- Repeat back from ooo to xxx
- 1 & 2 } chocolate — 9 picks
- 3 & 4 } chocolate — 9 picks

No. III

Harnesses

- 1 & 2 } bisque — 8 picks
- 3 & 4 } bisque — 8 picks
- 1 & 2 bisque } 4 times (or 8 picks)
- 3 & 4 vanilla } 4 times (or 8 picks)
- 2 & 3 bisque } 4 times
- 1 & 4 vanilla } 4 times
- 1 & 2 bisque } 6 times
- 3 & 4 vanilla } 6 times
- 1 & 2 } bisque — 10 picks
- 3 & 4 } bisque — 10 picks
- 1 & 2 } vanilla — 10 picks
- 3 & 4 } vanilla — 10 picks

No. IV

Harnesses

- 1 & 2 } rust — 8 picks
- 3 & 4 } rust — 8 picks
- 1 & 2 } bisque — 9 picks
- 3 & 4 } bisque — 9 picks
- 1 & 2 d.b. } 6 times (or 12 picks)
- 3 & 4 chocolate } 6 times (or 12 picks)
- 2 & 3 d.b. } 2 times
- 1 & 4 chocolate } 2 times
- 1 & 2 d.b. } 2 times
- 3 & 4 chocolate } 2 times
- 2 & 3 d.b. } 2 times
- 1 & 4 chocolate } 2 times
- 1 & 2 d.b. } 2 times
- 3 & 4 chocolate } 2 times
- 1 & 2 } rust — 7 picks
- 3 & 4 } rust — 7 picks
- 1 & 2 } vanilla — 5 picks
- 3 & 4 } vanilla — 5 picks
- 1 & 2 } d.b. — 9 picks
- 3 & 4 } d.b. — 9 picks
- 1 & 2 } bisque — 9 picks
- 3 & 4 } bisque — 9 picks

No. V

Harnesses

- 1 & 2 } chocolate — 12 picks
- 3 & 4 } chocolate — 12 picks

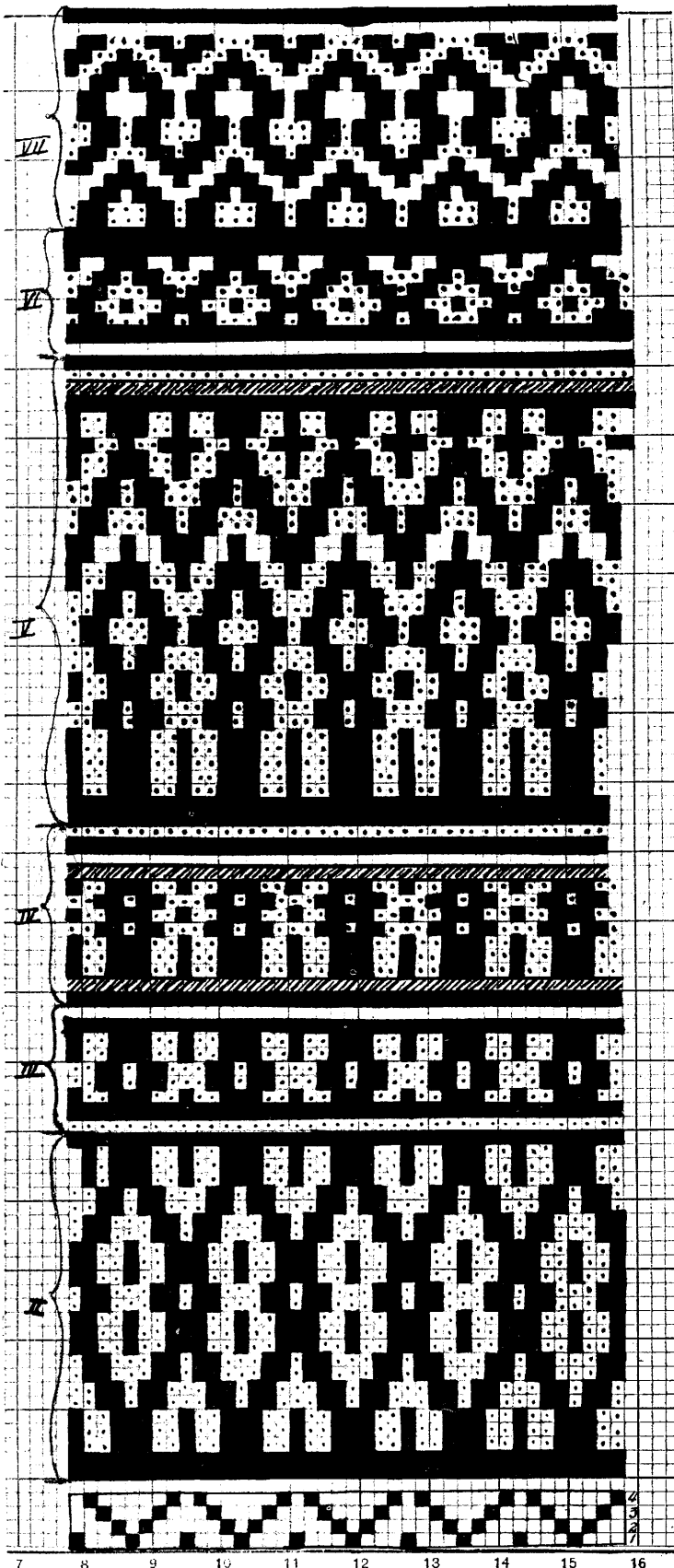

Diagrams II, III, IV, V, VI, VII

gested, but these are only a beginning of the seemingly endless combinations which are possible.*

* Note: From here on, directions for weaving borders are given by harnesses—the tie-up and resultant pedaling to be left to the discretion of the weaver.

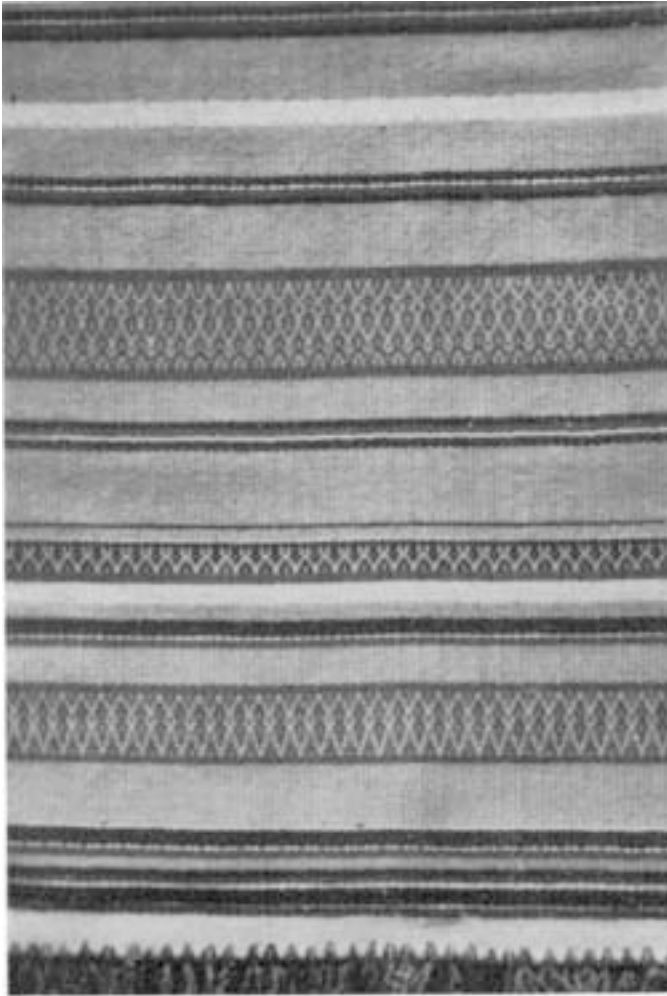

Illustration No. 1

- 1 & 2 chocolate } 10 times (or 20 picks)
- 3 & 4 bisque }
- 2 & 3 chocolate } 4 times
- 1 & 4 bisque }
- 1 & 2 chocolate } 4 times
- 3 & 4 bisque }
- 2 & 3 chocolate } 4 times
- 1 & 4 bisque }
- 3 & 4 chocolate } 4 times
- 1 & 2 bisque }
- 2 & 3 chocolate } 4 times
- 1 & 4 bisque }
- 1 & 2 chocolate } 4 times
- 3 & 4 bisque }
- 1 & 4 chocolate } 4 times
- 2 & 3 vanilla }
- 3 & 4 chocolate } 4 times
- 1 & 2 bisque }
- 2 & 3 chocolate } 4 times
- 1 & 4 bisque }
- 1 & 2 chocolate } 4 times
- 3 & 4 bisque }
- 1 & 4 chocolate } 2 times
- 2 & 3 bisque }
- 1 & 2 chocolate } 4 times
- 3 & 4 bisque }
- 1 & 2 } d.b. — 4 times
- 3 & 4 }

- 1 & 2 } rust — 7 picks
- 3 & 4 }
- 1 & 2 } bisque — 7 picks
- 3 & 4 }
- 1 & 2 } chocolate — 9 picks
- 3 & 4 }

No. VI

Harnesses

- 1 & 2 } vanilla — 6 picks
- 3 & 4 }
- 1 & 2 } d.b. — 7 picks
- 3 & 4 }
- 3 & 4 d.b. } 2 times (or 4 picks)
- 1 & 2 bisque }
- 1 & 4 d.b. } 2 times
- 2 & 3 bisque }
- 3 & 4 d.b. } 2 times
- 1 & 2 bisque }
- 2 & 3 d.b. } 2 times
- 1 & 4 bisque }
- 1 & 2 d.b. } 2 times
- 3 & 4 bisque }
- 1 & 2 } d.b. — 8 picks
- 3 & 4 }

(Continued on page 31)

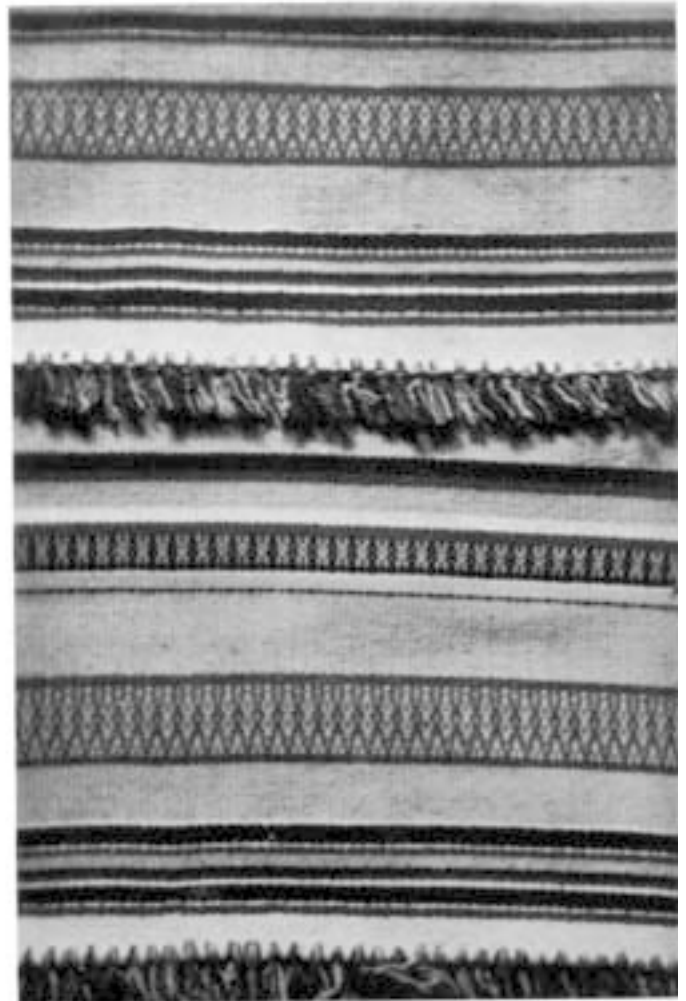

Illustration No. 2

Questions and Answers

ADDRESS YOUR QUESTIONS TO MRS. MARY M. ATWATER, BASIN, MONTANA

Question: What weave can one use to cover the warp completely with weft?

Answer: This is not so much a matter of weave as of choice of material and setting of the warp. A number of weaves may be used. The warp should be coarse and set much farther apart than for ordinary weaving and the weft should be rather finer than the warp. The correct warp-setting cannot be given, as this depends on the material used.

A fine warp may be used if one wishes, but a number of warp-ends must be threaded through the same heddle, or through heddles on the same harness. The latter is the better practice as the threads tend to twist together when several are drawn through the same heddle. For instance, thread: 1, 1, 1, 2, 2, 2, and so on.

The warp should be stretched tighter for this form of weaving than for ordinary weaves, and the weft must be very firmly beaten up. As the take-up is all in the weft, plenty of slack must be allowed in the weft or the fabric will tend to narrow in. If this is permitted it will become impossible to beat firmly enough and the weave will be ruined. A template may be required to keep the web out to the correct width. There are, however, draw-backs to the use of a template and this should be avoided if possible.

The plain weave, woven in this manner, produces a heavy ribbed fabric with the ridges running lengthwise.

Pattern weaves may be used, also. The ordinary overshot weave, however, is rather impractical as the fabric is not closely enough combined over the pattern blocks to be durable. "Summer and Winter" weave and the "Crackle" weave give good results. Weave "on opposites" in two colors. For instance, if the weave is crackle weave and the first shot is on the 1-2 shed, follow it with a shot in the other color on the "opposite" or 3-4 shed. Repeat these two shots as may be required for the pattern block. An occasional shot in a fine tabby thread may be used in this form of weaving and helps to keep the warp-threads from bunching together and helps to keep the web out to the correct width. The tabby

should not show. Weave four or six or even eight shots of "opposites" between the shots of tabby. The same technique may be used in Summer and Winter weave. If the pattern block is, say, on shed 1-3, weave all the other harnesses for the "opposite" shot. A tabby may be used at intervals as explained above.

An interesting Scandinavian weave in which the warp is covered is produced as follows: Use a coarse warp, set far apart, and thread either plain twill or the "Bird-Eye" or "Rosengang" pattern — 1, 2, 3, 4, 1, 4, 3, 2, and repeat. Sink a single harness for each shot of weft and weave harnesses 1, 2, 3, and 4 in this succession throughout. The pattern effects are produced in great variety by using different colors for the different shots. The face of the fabric will be firm and hard, but there are skips on the back that make the wrong side unsightly. This is a good weave for upholstery and similar fabrics, but not for pieces in which both sides are in evidence.

It must be borne in mind that all unbalanced fabrics of this order are much thicker and heavier than fabrics woven with warp and weft approximately alike in kind and number of ends to the inch.

Question: How may one produce a fabric in which the warp completely covers the weft?

Answer: This effect may be produced by setting the warp very close together and using fewer weft shots to the inch than there are warp-ends in the setting. Many primitive fabrics have this structure; also a type of mat characteristic of Scandinavian weaving and recently described in *THE WEAVER*, is of this order. The weave is not very popular among American weavers — possibly because the preparation and entering of the warp is much more troublesome than for an ordinary warp, and because it is very difficult to open the sheds. A great range of pattern effects is possible in warp-face weaving, however, and perhaps we should use it more.

A form of warp-face weaving less troublesome than the similar weave on an ordinary loom is "Card-Weaving."

INTERESTING WAYS TO USE LAID-IN TECHNIQUE

(Continued from page 7)

over and over again, rather than even attempt to try to work out anything which is really their own. There is much real pleasure in creating your own designs, and this is entirely lost if you continually copy what someone else has done. Find new ways of using designs, new ways of using color, new ways of using both old and new yarns and threads. All of these things help to increase your own development and growth. The interest in handweaving is steadily growing,

THE WEAVER

and in time fabrics of real value and beauty, produced by the handweaver in her own home, for her own pleasure and use, can have a substantial influence even on commercial fabrics produced by machine, by mass production for mass consumption. Because, if I am to judge by any of the results I am achieving in my weaving classes, even the most simple weaving and principles of design which are being experienced by many of these people for the first time, serve to stimulate not only their interest in fabrics, but also to make them more thread conscious, as well as design conscious. All of which will eventually do much to influence their selection of the fabrics which they purchase for use in their homes.



Weaving department at Kingswood School, Cranbrook

Studio of Loja Saarinen. Window drapes in green and gray linen and lustrone

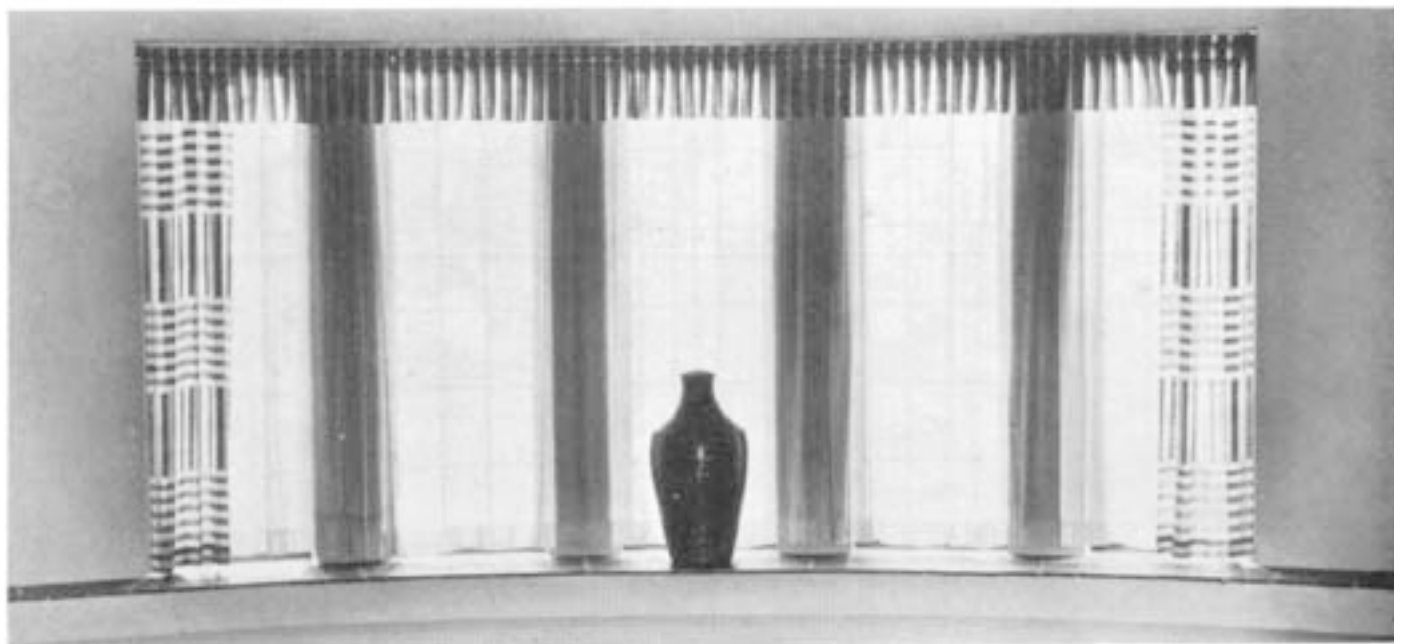



Studio of Loja Saarinen. Textile exhibition held at Cranbrook with a reception room rug, 12 x 27 feet, in green and gray shades

The Weavings of Loja Saarinen

BY FLORENCE DAVIES

Art Critic at the Detroit News

THE Cranbrook weavings of Loja Saarinen were created to meet a definite need.

This need was not of a material nature, since the world was full of all manner of woven fabrics at the time that Mrs. Saarinen first set up a loom at the Cranbrook Academy of Art in the beautiful Bloomfield Hills, Michigan.

Neither was this need a subjective or personal thing, such as the need of the individual for self-expression, or of children at play who cry, "Let's make something — what shall it be?", a motif which inspires too many experiments in handicraft.

It was at once, more immediate and definite than that.

It was born of that larger necessity which springs from the age itself, a need to live intelligently in relation to our own

time and place — to believe in Walt Whitman's sound dictum, "not some other place, but this place; not some other time, but this time."

To understand why Mrs. Saarinen, in a world full of textile factories and the looms of art weavers, first started to design and weave rugs and textiles, one must understand something of the woman herself and her present environment.

Loja Saarinen is one of a family which of itself forms a close corporation of working artists. An artist in her own right, she is the wife of Eliel Saarinen, world-famed architect who is now resident architect for the Cranbrook Foundation, Bloomfield Hills, and director of the Cranbrook Academy of Art, one of the Foundation's activities.

Mr. and Mrs. Saarinen and their two children, a daughter and son, have always lived naturally and normally in an atmosphere of artistic creation. Even when their son and daughter were hardly more than children, their family life



Studio of Loja Saarinen. Luncheon set of black, gray, white, and natural linen

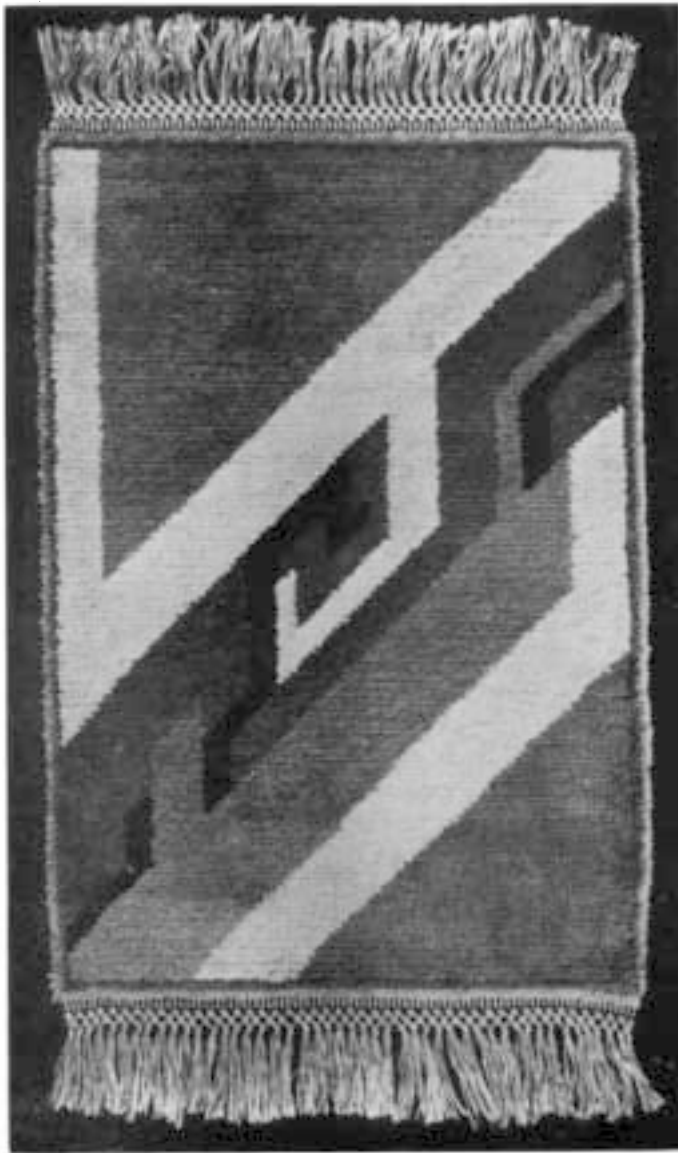

household, since often after-dinner guests instinctively wander on through the drawing room to the small lounge or conversation center at one end of the big studio, because this room seems to be the most vital place in the house.

Now, all this may seem to be far removed from the Cranbrook weavings. But it is not, because in order to understand their significance, one must understand that they were created in an atmosphere where things needed are made, not ordered, and where creative effort and achievement is as natural as breathing.

Thus it came about that while discussing the appointments of the contemporary buildings which Eliel Saarinen was designing for Cranbrook, Mr. George G. Booth, the founder, turned to Mrs. Saarinen one day and said, half in the spirit of playful challenge, "What are we going to do for rugs and textiles to go with these new buildings, and the contemporary furnishings which your husband is designing?"

"Why don't you design some for us and let us send them to Finland where they do such beautiful weaving and have them woven on those looms?"

It was characteristic of Mrs. Saarinen that she was not interested in such half measures.

"Why not design them and weave them here?," she answered, meeting one challenge with another.

No sooner said than done. Mrs. Saarinen at once set about designing rugs, and a loom of medium size was immediately installed.

The first task which Mrs. Saarinen set for herself was the designing and weaving of a wall hanging to be used over the fireplace in a dining room which Mr. Saarinen was creating for the exhibition of ten contemporary American interiors by ten American architects, which were shown several years ago by the department of Industrial Art in the Metropolitan Museum of Art, under the direction of Richard Bach.

by Frances H. Reese, student at Cranbrook Academy of Art

The result was like a breath of fresh air in early spring.

Here was freshness, restraint, beauty and fitness for purpose.

The designer had not dipped back into the past of Europe and brought forth an outworn pattern as reminiscent of ancient elegance as some threadbare old dowager whose costume had been made over once too often.

Neither had she striven so desperately to be new and different that she had created the sort of unreal, highly artificial, purposely fantastic design which some people imagine represents the spirit of today, so that the very word modern has become at times a reproach.

On the contrary, here was simplicity, intelligence, restraint. Because Mrs. Saarinen knows that in an age of highly developed mechanical means, of steel construction, with its clean, sheer lines, in an age of science and studied efficiency, the bizarre, the disordered and the self-conscious have no place.

Again because this first weaving was designed to hang on a wall above the fireplace, it was logical that the design should grow upward. What better suited to such a purpose than the tree motif? So a tree was chosen as a theme, but it was not a naturalistic or a painted tree, first because weaving is not painting, nor should it strive to reproduce the effect of painting; and second because naturalistic forms are not essentially expressive of our time. Thus the pattern must have clean, sheer lines, must have almost geometric simplicity and a certain clarity and restraint.

Other weavings for floor, window hangings and furniture coverings followed as one loom after another was acquired. Rugs, however, have always been her major achievement, though she has made delightful textiles for use as upholstery fabrics and curtains.

Her rugs are always simple and impersonal in design as befits a floor covering in a contemporary house. More than this, they bespeak the contemporary spirit in their clean, logical patterns which impart a sense of great beauty and strength because of their definitely architectural quality.

As a rule Mrs. Saarinen feels that the cool colors are more representative of the intellectual rather than sentimental or emotional spirit of this machine age, and she chooses most often the grays and browns and greens of the earth, the cool light grays of steel, the rusts and reds, and the precise lemon yellows and warmer yellows with some greens, with black for emphasis and white for high light.

When the Fifth Avenue show room for Hudnuts was installed several years ago, Mrs. Saarinen was given the commission for the rug and produced a distinctive pattern in cool lemon yellow, with grays and browns. More recently when the new setting was designed for the Yardley's shop,

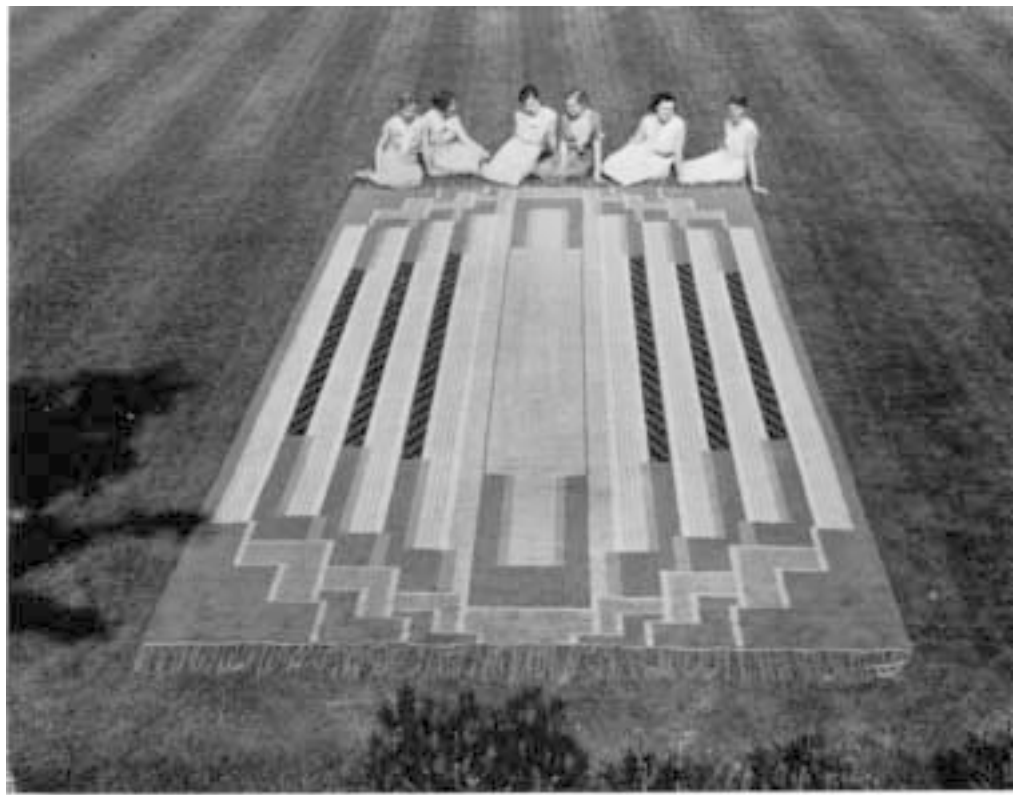

Studio of Loja Saarinen. Reception hall rug for Kingswood School, Cranbrook, 12 x 26 feet. In bronze and grays with a warm Chinese red

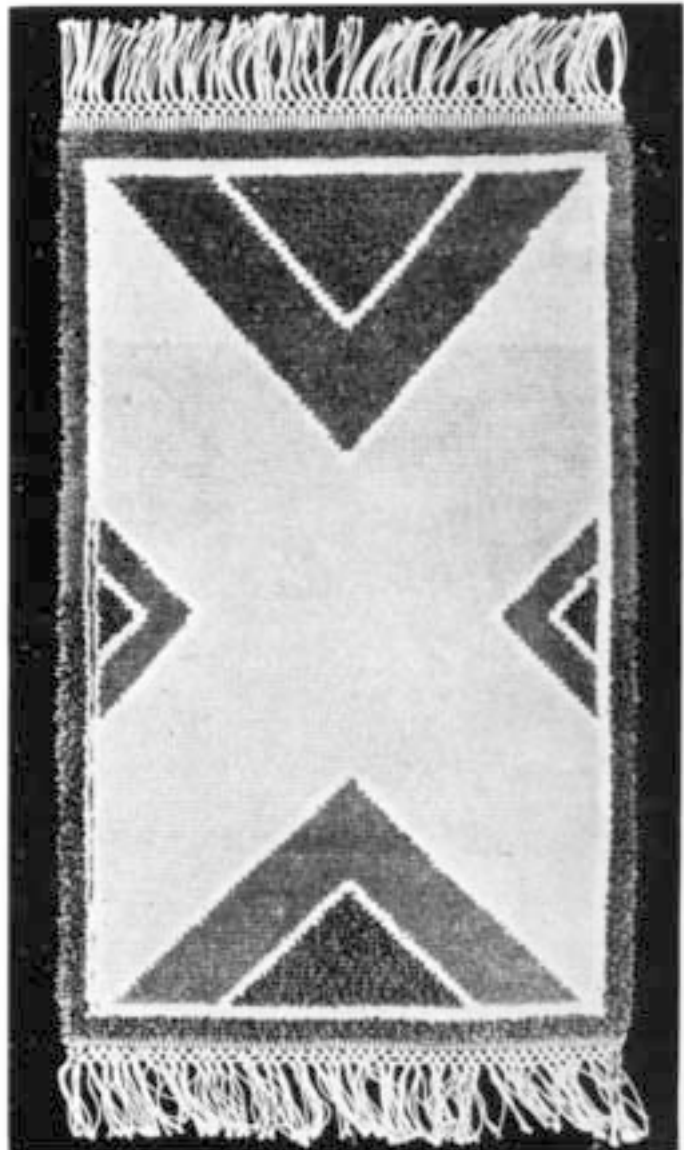

by Ann Henry, student at Kingswood School, Cranbrook

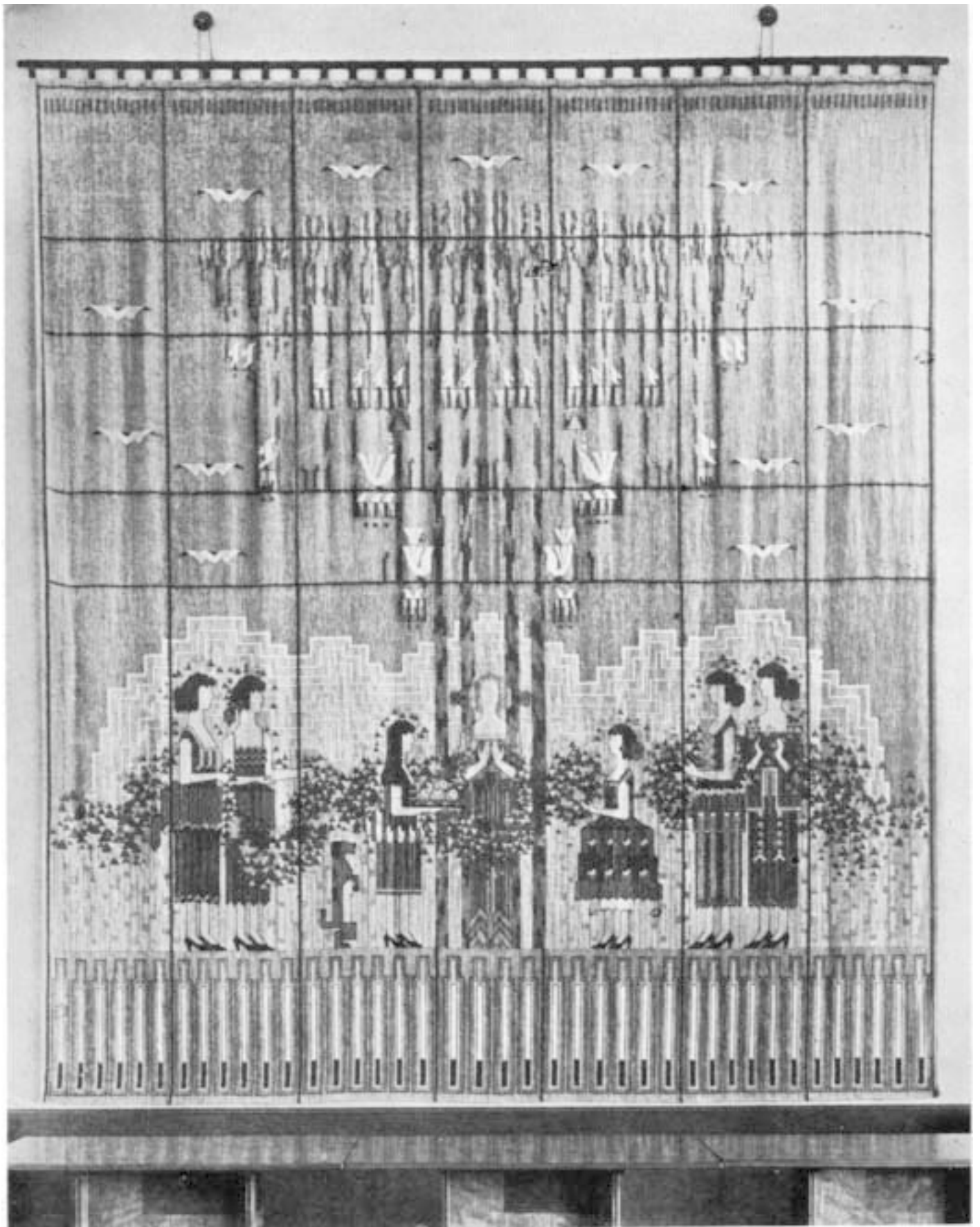

Studio of Loja Saarinen. Tapestry, 16 x 18 feet, in coarse homespun linen and wool. Prevailing colors: green, coral, and white



by Barbara Bennett, student at Cranbrook Academy of Art



by Mrs. Lionel Heap, student at Cranbrook Academy of Art

also on Fifth Avenue, Mrs. Saarinen designed a round rug in rose and gray with stunning accents of black and white, which was admirably suited to the purpose.

Thus from the small beginning of a single loom, Mrs. Saarinen now has at her disposal at Cranbrook about thirty-five looms, three of which are master looms, twelve feet wide, which require the services of three weavers when in operation.

The chief value of the hand-woven curtain fabric, Mrs. Saarinen explains, is the fact that in no other way can the texture and color of the fabric be so perfectly controlled in relation to its surroundings, or made so logical a part of a given whole.

It was because of the necessity of something which belonged wholly to the room that Mrs. Saarinen undertook a great tapestry or wall hanging, which must be reported as one of her major achievements.

As usual the artist started with a need. This need was a large bare wall at the end of the girls' dining room at Kings-

(Continued on page 31)

by Kathleen Green, student at Cranbrook Academy of Art

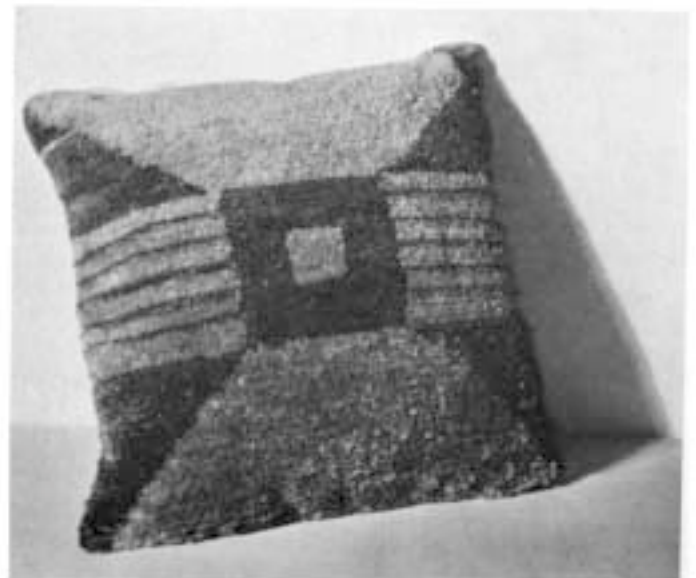

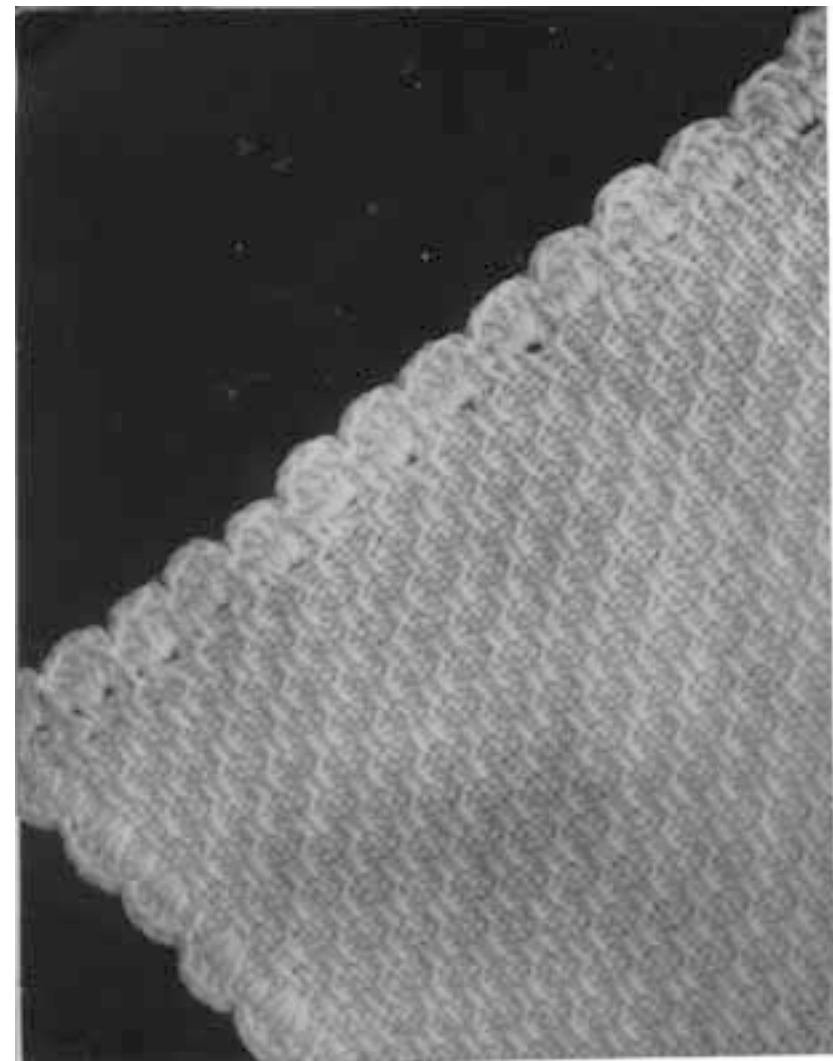

Illustration No. 1 Bronson Weave

Baby Blankets

BY VEVA N. CARR

THE results of an urge to know first-hand what could be done with the numerous materials and weaves suggested for baby blankets, may be of interest to some of your readers.

An all-Saxony blanket on the little Bronson draft known to all Shuttle-Craft weavers proved very satisfactory from a commercial standpoint. With the minimum amount of time and material required in the construction of a blanket of this type, it can be sold far more reasonably than most of the others.

A rather nice and inexpensive variation in the finish of this weave proved to be a crocheted edge done in a shell stitch, as shown in Illustration No. 1. The cut ends of the blankets were stitched a couple of times and carefully trimmed before crocheting the shell, which was done by taking a single crochet in one block of the pattern, and four double crochet stitches in the next block, and repeating around the four sides of the blanket.

A second stringing, shown in Illustration No. 2, proved a happy solution for a superfine blanket for the "finest baby in the world," when done on a spun silk warp set at 30 threads to the inch and a three-fold Saxony yarn.

These blankets were made on Draft (a), taken from Mrs. Mary M. Atwater's Shuttlecraft Book, which gives it as a stringing of a blanket in the Metropolitan Museum, New York, and were set 40 inches in the loom.

Instructions for the little figures shown on the drawing should prove much easier to follow than a long detailed instruction of weft shots. They are treadled as follows:

- | | |
|---------------------|---------------------|
| (a) Treadle 1, once | (b) Treadle 3, once |
| " 2, " | " 2, " |
| " 3, " | " 1, " |
| " 4, 4 times | " 4, 8 times |
| " 3, once | " 1, once |
| " 2, " | " 2, " |
| " 1, " | " 3, " |
| " 4, 4 times | |
| (c) Treadle 1, once | (d) Treadle 1, once |
| " 2, " | " 2, " |
| " 3, twice | " 3, " |
| " 2, once | " 4, " |
| " 1, " | |

First Blanket on Draft (a)

Weave (a) in white for 3 inches

- * " (b) " "
- " (a) " " 3 times
- " (b) " " once
- " (c) " pink; (b) white
- " (c)* 3 times, using white on the 1st and 3rd sheds, and pink on the 2nd and 4th
- " (c) 5 " reversing the colors; pink on the 1st and 3rd, and white on 2nd and 4th
- " (c)* 3 " (same as c* above)

Treadle 3, pink; treadle 4, white } Repeat 5 times
 " 3, " " 1, " }

Reverse to *.

For body of blanket weave (c) for 34 inches, and repeat the border and 3-inch heading.

Second Blanket on Draft (a)

The Miro wools used in the following blankets produced a heavier texture, which lacked some of the softness and elasticity of the Saxony wools.

The borders were treadled as follows:

- (a) Treadle 3, blue; treadle 4, white
 - " 3, " " 2, "
 - " 1, " " 4, "
 - " 1, " " 2, "
- Repeat above.
- Treadle 3, blue; treadle 4, " } 4 times
 " 3, " " 2, " }

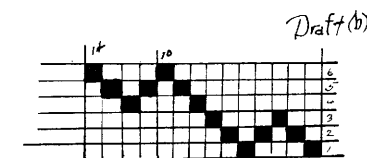
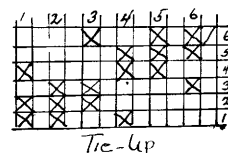
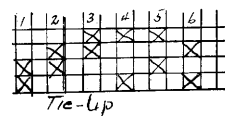

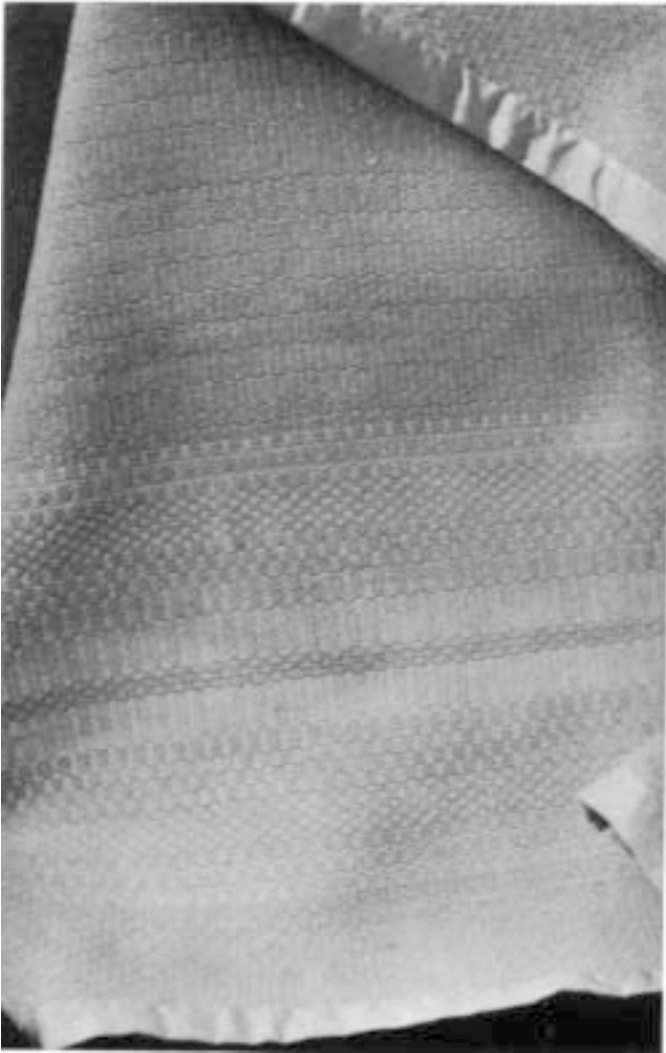

Illustration No. 2 (Draft A)



Illustration No. 3 (Draft B)

- “ 1, “ “ 4, “ } 4 times
 “ 1, “ “ 2, “ }
 “ 3, “ “ 4, “ } 4 times
 “ 3, “ “ 2, “ }
 “ 1, 2, 3, 4, blue }
 “ 1, 2, 3, 4, white } 4 times
 “ 1, 2, 3, 4, blue }
 (b) Treadle 1, 4, 1, 2, white } twice
 “ 3, 4, 3, 2, “ }
 (c) Treadle 1, 4, 1, 2, blue } once
 “ 3, 4, 3, 2 “ }
 Repeat (b).
 Treadle 1, blue; Treadle 2, white
 “ 3, “ “ 4, “
 “ 1, 4, 1, 2, blue
 Reverse to beginning.

Many variations are possible in this lovely little draft and one never tires of making the dainty patterns.

These blankets, too, were stitched across the ends before cutting and bound with an A-1 grade of white or colored satin ribbon folded over the edge; the corners were carefully mitered and the edges caught down with a blind stitch. By creasing the ribbon through the center it is no trouble to keep the width of the ribbon the same on both sides.

(Continued on page 31)

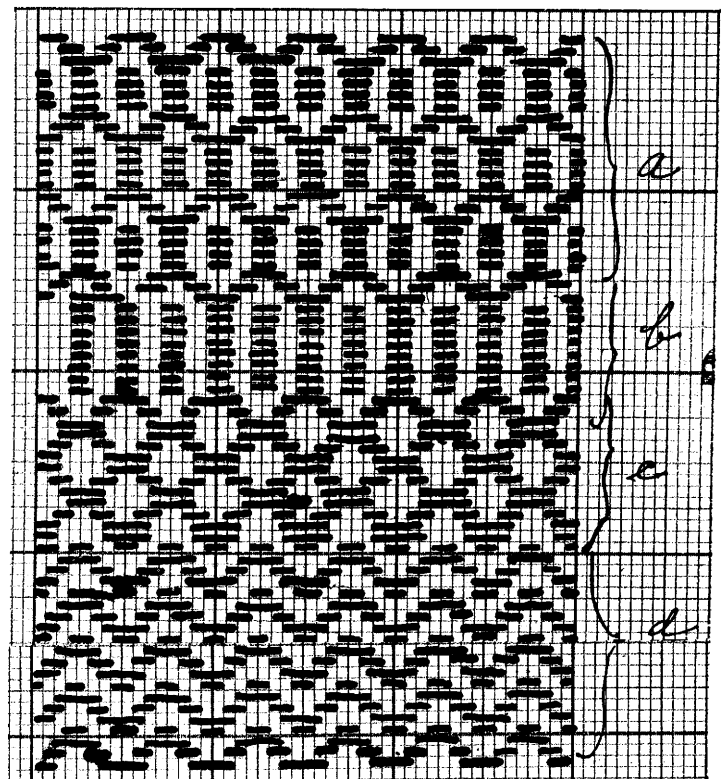

Draft A

Scandinavian Art Weaving

BY ELMER WALLACE HICKMAN

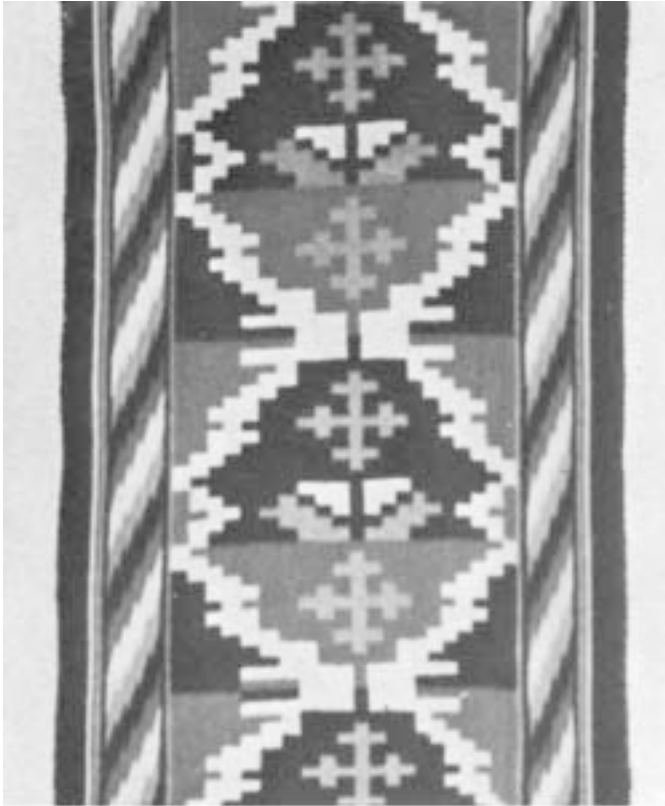

Illustration No. 1
Wall-hanging in Norwegian Åklæ. Colors: black, gray-green, medium brown and natural. Woven by Mrs. Olivia Kindleberger

Illustration No. 2
Wall-hanging in Swedish Röllakan. Colors: red, brown, yellow, green, white. Woven by Miss Sara Mattsson



SCANDINAVIAN Art Weaving is too little known in this country. And that is unfortunate; for once possessing the knowledge about the several Scandinavian techniques and the ability to apply this knowledge at the loom, many enjoyable hours can be spent and fabrics will be produced that will be a revelation to one's dexterity.

There are diverse reasons why Scandinavian Art Weaving is so little known to our American weavers: the principal ones being, I should surmise, the unfamiliarity of our American weavers with this type of weaving, actually; the lack of information about these techniques; and the mistaken idea that this work requires too much time to complete any sizable textile. Those of you who are familiar with the Scandinavian illustrations that have appeared in the old *Handicrafter* have wished, I imagine, — as I had often wished, — to know how the actual weavings were done; and even, perchance, that one could know the secret of those supposedly intricate-looking techniques. None of these techniques are difficult to learn. One can master any of them with a little patience, competent instruction, and persistent application. In the Swedish and Norwegian Art Weaving books there can be seen examples of the many techniques with which most Scandinavian weavers are acquainted, but the accompanying text — even with a very adequate translation — offers such vague and meager instruction that no one, unacquainted with these techniques, could possibly gain sufficient information with which to acquire a proficient working knowledge of them.

It is for the last-mentioned reason that I wish to write a series of articles, giving a comprehensive working knowledge of the principal techniques, so that from the beginning craftsmen can readily follow the procedure, understand intelligently how particular techniques are done, and be able to master that technique. I trust the information will prove not only beneficial but act as an incentive and an influence to try some of the work.

Since I have learned these techniques they have greatly won my admiration. Several years ago I had tried unsuccessfully to locate competent weaving instructors from whom I could get this information. I finally, after repeated attempts, found Mrs. Olivia Kindleberger, a gracious Norwegian lady of some seventy odd years, in New York City, and Miss Sara Mattsson, who is an excellent teacher of Swedish weaving. Miss Mattsson was at the St. Louis School of Fine Arts but is now located at the Cleveland Art School.

These "attempts," as I recall, resulted in experiences that were varied and vastly amusing. One particular experience I

remember only too well. Several names were given me by an art alliance. With great expectation I chose first to seek out the weaving instructor whose name on the list was most highly recommended. In a downpour, such as, perhaps, New York had never seen, I eventually located the studio. With ravenous hunger in my heart for some coveted instruction, I stated very clearly my want to the charming, and really intelligent, person who admitted me to the studio. I eagerly awaited her response. Her favorable response belied her countenance and a growing suspicion began to creep over me. This most hospitable lady dragged out some Colonial over-shot pieces. I told her that it was not that type of weaving I wished to know. Evidently eager to get a new student, she took me to a loom and asked me if that was what I wanted to learn. And there I peered — not in amazement but in disgust — upon another Colonial design of what was some day to be a coverlet. “No,” I told her, as politely as I could, and with a murderous glint in my eye I gracefully — as gracefully as a six-foot rain-drenched individual could — bid the charming lady adieu and made my way to the street. I wondered, upon reaching the street, whether it was worthwhile looking farther; but my persistence was awarded, after several days’ search, when I found Mrs. Kindleberger.

Please understand that I am not condemning our Colonial weaving — far from it. To me Colonial weaving has always been a rich heritage, full of a national characteristic that is ours and ours alone; and for anyone to propound a substitute is fallacious. Colonial weaving will remain — as will Scandinavian Art Weaving — a distinctive classification in itself, and will continue thus to solidly stand (thanks greatly to the untiring efforts of Mrs. Mary Meigs Atwater) as an ever-undimmed memory of a hallowed past. In introducing these Art Weaving techniques I wish only to urge our weavers to acquire as broad a weaving knowledge as possible.

In the Scandinavian countries, it seems as though the greater part of hand-made textiles are those done in the Art Weaving techniques. Growing developments, recent and otherwise, have brought about the establishing of thirty Swedish Home-craft (Svenska Hemslöjd) Societies. Similar admirable projects have been instituted in Norway. To quote a few of the statements, made in an English translation, from a special catalogue of the “Home Craft,” one can see the ideal for which the Swedish Hemslöjd movement stands:

“The foundation of the vigorous home craft activity of present-day Sweden was laid in the sixties and seventies of the past century, when a beginning was made in a rational collection of old Swedish peasant craft products and of copying such products; schools and courses were established for home craft . . . none of the old methods of Art Weaving would seem to be entirely lacking in Sweden — not even the primitive and rare, which is known from Egypt, Soumak-weaving is absent from Sweden . . . nearly every region throughout the wide domain has created for itself its own traditions, . . . and has come to feel more and more serious responsibility that these regional units should be able to preserve, as far as possible, their identity in the practice of art . . . many of the fighting-cocks of arts and crafts ask how long home craft will be able to hold its own under the increasing pressure of industrialization. One point, however, it would seem impossible to dispute; and this is, that if home craft is to be continued as a living force, it will also continue to possess an altogether special strength so long as it main-

THE WEAVER



Illustration No. 3
Wall-hanging in Dukegång. Colors: rust, gray-green, medium brown, tan, medium blue, dark blue and gray-blue. Woven by the author

tains its safe anchorage in the traditions that have been created within each several region by past generations.”

Furthermore, Nils P. Wollin in his “Svenska Textilier,” remarks:

“If we were deprived of crafts it is not only our textile art but our Swedish culture that would be the poorer. Sloyd has been car-



Illustration No. 4
Wall-hanging in Dukegäng and Half-Krabba.
Colors: different tones of tans and browns. Woven
by Miss Sara Mattsson

ried on for centuries out in the countryside, both in forest districts and on fertile plains, and is still flourishing. . . . It is evident from its continual development that the Swedish sloyd industry is not an artificial, romantically emphasized movement; it is an urge springing from ancient traditions — thus the old traditions are reverently preserved, and incidentally an aesthetic sense of color and form. It is a peculiar thing that many of the methods that were introduced into Sweden in the olden days are still preserved here, whereas in Europe otherwise they are only to be seen in museums.”

I do not pretend this introductory article to be an archaeological survey — for I fear most of us weavers are not greatly interested in such material — but I do wish that the brief descriptions of the principal Art Weaving techniques will act as a catalogue, so that one will be sufficiently informed about this classification of weaves.

The Art Weaving techniques that are most prevalently used in Norway and Sweden — although known by different names in each of these countries — are listed below:

1. Åklæ (Norwegian) or Röllakan (Swedish) is a half-gobelin tapestry weave with the front side of both fabrics apparently the same. It is sometimes called low-warp tapestry. In high-warp tapestry, such as French tapestry, no reed is used and the units of design are built up in sections, while the weft is beaten down with a tapestry fork or comb. But in Åklæ and Röllakan a reed is used and the



Illustration No. 5
Wall-hanging in Krabbasnår (bottom design) and
Half-Krabba (middle and top design). Colors:
tans, rust and browns. Woven by the author

design is woven row after row clear across the width of the warp and beaten down stealthily with the reed. The technique used in Norwegian Åklæ is such that either side of the weaving is practical for usage, while, because of the different working technique, only the front of the Swedish Röllakan can be used. Associated with the Norwegian Åklæ is the technique known as Lynildbordvevning or Lightning weave. It is a succession of zigzags. The technique is similar to the Åklæ technique, but no interlocking takes place while weaving.

2. Dukegäng (Swedish) or Sjonbragd (Norwegian) is a laid-in technique — usually of geometrically designed figures — either with both the design (or pattern) and the background raised entirely across the web, or with only the design laid-in, raised, and the background in flat weave (tabby). This is a most interesting and engaging technique. Illustration No. 3 shows the small borders with only the design raised, while the main designs as well as the background are woven in the Dukegäng method.

3. Swedish Krabbasnår is a so-called embroidery weave



Illustration No. 6
Rug in Rya. "St. George and the Dragon." Colors: red, black and gray. Designed and woven by Miss Sara Mattsson

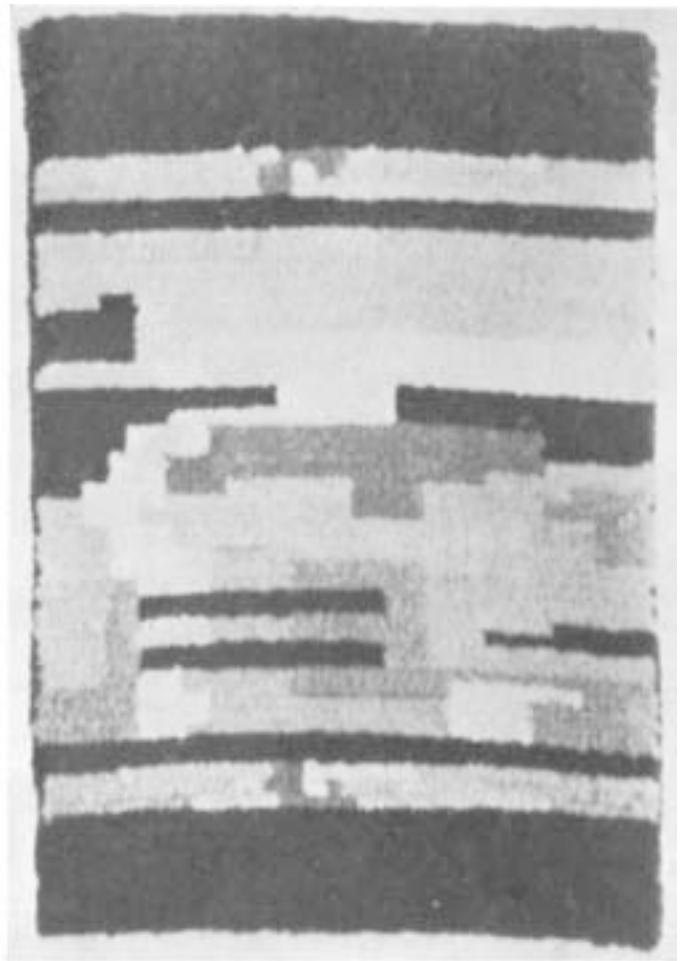

Illustration No. 7
Rug in Flossa. Colors: yellow-red, gray-green, black, gray-blue and blue-green. Woven by the author

that decorates the flat weave of the background. This is an extremely slow process. Each square on cross-section paper represents a pattern change in this technique.

4. Half-Krabba is similar to Krabbasnår except that a square on cross-section paper represents three pattern shots before a change is made. The main idea is to work over three warp threads and under three warp threads. Illustration No. 5 is a combination of these two techniques.

5. Flossa is a knotted and tufted surface. This technique can be used in many fabrics beside the customary pile rug. The knot is similar to the Turkish or Ghiordes knot, although it is believed that the Flossa knot was an independent development in Norway and Sweden, and not copied from the Ghiordes. The knots were originally tied in separately with short pieces of wool yarn, but now steel guides about $\frac{3}{8}$ of an inch high are employed. These guides are made so as to form two pieces of steel with a slit throughout the length, in which a Flossa knife travels to cut the loops that have been

tied around this guide and the warp. These loops then form a tufted surface or pile. In Flossa the entire surface is covered with these tufts. For the weft good strong rug yarns of varying thicknesses are used to make the loops. Finer yarns are tied into the warp for other articles, such as runners, pillow tops, bags, etc. Thick linen warp (No. 3 Seaming linen twine), hard twisted, and cowhair yarn for the foundation weft constitute the body of the rugs, usually. This technique is admirably explained in *THE WEAVER*, Vol. I, No. 1, by Mrs. Atwater.

6. Rya (pronounced Ree-ä), meaning "rough and shaggy," simulates the Flossa method of working. The loops are longer, being made with a steel guide about $\frac{7}{8}$ of an inch high. Because of the length of the loops, as many as ten foundation weft shots are seen in some of the rugs, between the pattern shots. The Rya rug is not as serviceable as the Flossa rug. Although we think of Flossa and Rya in terms of rugs, the use of them was seldom for floor coverings. They were used to cover carriage seats or a chair, or hung on walls for decoration, and often used for bed coverings. Only on festive occasions were they used on floors.

7. Half-Flossa is similar to Flossa except that the design only is made tufted and the background is of a flat weave.

8. Slaev-tjäll is nothing more than a Swedish glorified

rag rug. But the technique so transforms the ordinary rag rug that the old familiar fabric is hardly recognizable. A pattern is usually put in the loom and a design worked in over the rag foundation (botten inslag) with short pieces of rags or yarns. This is an interesting method to know, and one of the oldest types of fabrics to be found in the Scandinavian countries.

9. Upphämpta is done by placing sticks in back of the regular harness set-up. There may be any number of these sticks, according to the complication of the design. These sticks are so placed in the warp threads, back of the harnesses, that the raising of them makes for a pattern design. Long-eyed heddles are used on the regular front harnesses. An arrangement known as Dragrustning is also employed to accomplish this technique. The Dragrustning is a frame placed in front and at the top of the loom through which cords run to the added harnesses in back of the regular harnesses. These added harnesses consist of two sticks between which are strung cord heddles with regular-eyes, and are weighted down with miniature sash-weights of lead. Instead of the warp being picked up on the sticks as in regular Upphämpta, the warp is threaded through the eyes of the heddles on these added harnesses. These harnesses are in turn lifted from the front of the loom by pulling the cords. The cords are supplied with wooden handles; these handles are placed in slots in the frame, in front of the loom, to hold the pattern shed. The handles are then released when that particular shed is no longer wanted. Extremely intricate patterns can be woven by the Dragrustning method. Our regular four

harness looms can be easily equipped with a Dragrustning apparatus. An adaptation of this technique is discussed by Nellie Sargent Johnson in *THE WEAVER*, Vol. I, No. 1.

10. Rosepath and Monksbelt are also utilized greatly in certain types of Art Weaving. The resulting fabric is rather heavy because the wool weft is so thoroughly beaten down that all the warp is covered. This is made more possible because no tabby is used. This is an easy technique and one from which pleasing effects can be acquired.

11. Flamskvävnad or Flemish weaving is the real high-warp tapestry in the Scandinavian countries. The warp is nearly always flax. The design or cartoon is securely fixed to the back of the warp threads; and the outlines, forms, and colors are rigidly and faithfully followed. The weft recommended for Flamskvävnad is single-ply wool (4½ harvigt ullgarn) using three or four strands as one weft thread. This wool is similar to but finer than Bernat's Homespun. Somewhat like the Flamskvävnad is the Billedvevning (Norwegian) or Picture Weaving. A cartoon is used in a similar way as that used in Flamskvävnad. Both of these techniques are "built-up" in sections. There are no slits in Billedvevning because of the interlocking process. Both of these techniques, in the Scandinavian countries, are ordinarily done on upright looms. The weft recommended for Billedvevning is a two- or three-ply wool (3trd. ullgarn), the same that is used for Åklæ and Röllakan.

12. Finnweave and Soumak-inlay might also be added to this classification. Finnweave is a double fabric weave. The

(Continued on page 31)

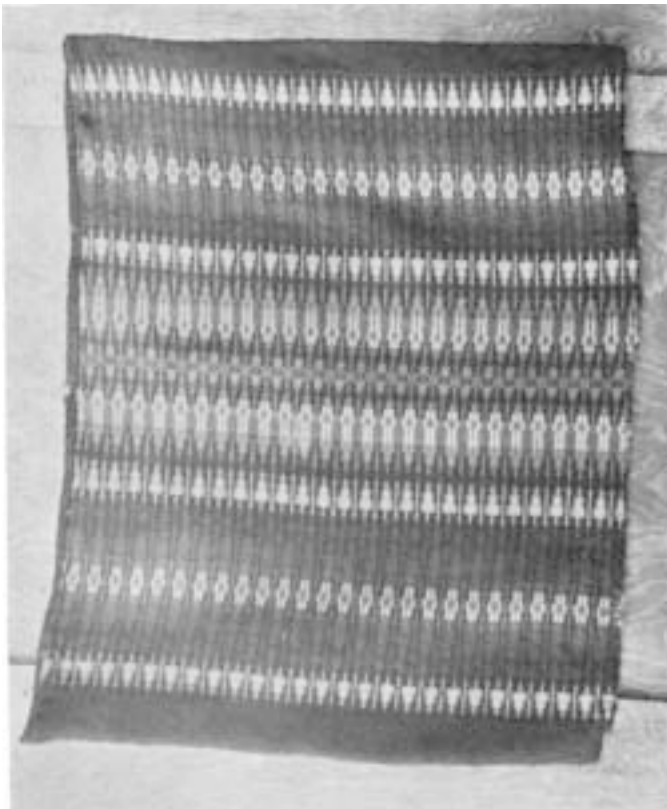

Illustration No. 8
"Bound Weaving." Colors: red, brown, yellow, white and green. Woven by Miss Sara Mattsson



Illustration No. 9
Wall-hanging in Finn Weave. Gray linen warp and maroon wool weft. Woven by Miss Sara Mattsson

“Stunting” on the Cards

BY MARY M. ATWATER

CARD-WEAVING is a fascinating little craft. Though it has about it some of the aspects of a game it is, nevertheless, a serious form of weaving — as technical in its way as weaving on a loom. Certainly there is nothing childish about it.

The fascination lies, I think, in the cleverness and ingenuity of the technique, and in the unique texture of the woven bands — strong, firm, thick and smooth — quite unlike the product of any other form of weaving. These fabrics, of course, are restricted to a few uses only, but for these uses are better than any fabric one can make on a “harness” loom.

One of the interesting things about card-weaving is the fact that the process lends itself to the doing of a number of things that cannot be done in any other weaving technique. On the cards one may weave around a square corner, for instance, or make braids and interlaced effects, to mention only two of the special possibilities.

But before explaining how these things may be done, I wish to describe a special method of warping and threading that saves a great deal of time. This method is not practical for all patterns; in fact it is limited to those patterns in which each card carries the same colors, such as the patterns shown on Diagram No. 1, Drafts 1 and 2.

Draft No. 1 gives the threading used for the more elaborate effects in card-weaving — initials, free designs, and the interesting Egyptian “lotus” and “big triangle” effects, double weaving after the Finnish method, etc. Draft No. 2 is the familiar diamond or chevron pattern that can be woven in so many different ways.

To set up Draft No. 1 by the process to be described, have ready four spools of warp material, — two in a dark color and two in a light shade. These spools may be set on a creel or spool rack, or may simply be put in a box on the floor. Arrange the cards in pairs, as indicated on the sketch and in the following order: 1 (1); 2 (2); 3 (3); 4 (4), and so on, placing the cards directly over each other with the lettered holes corresponding. Thread the four spools of warp through the entire pack, light threads through the A- and B-holes and dark threads through the C- and D-holes.

The warp should be wound as usual, over two supports, — pegs or hooks in the wall or over two chairs set at a suitable distance apart. When the pack of cards has been threaded, attach the strand of four threads to one of the supports, draw out the warp from the spools and run the pack of cards along the strand. When a point about halfway between the supports is reached, drop off the bottom card from the pack and allow it to hang on the warp. Bring the pack of cards around the second support and halfway back to the starting point. Here drop off another card from the pack. Proceed in this manner till all the cards have been dropped and warping and threading is complete. Before beginning to weave, rearrange

the cards in the order shown in the draft. The cards will twist toward the center.

If it is desired to have all the cards twist one way, set the supports closer together and drop all the cards at the same point; cut the warp at one end only, the complete round making the length of the warp.

Draft No. 2 is threaded and warped in the same manner; the cards must, however, be differently arranged before threading. It will be noted on the draft that the thread of a color indicated thus: (“) is threaded through the A-hole in card No. 1, the D-hole in card No. 2, the C-hole in No. 3 and the B-hole in No. 4. Arrange the cards in pairs to correspond with this threading. That is, arrange them in 1 (1); 2 (2) order as for Draft No. 1, but instead of making the lettered holes correspond set the second pair with the D-hole over the A-hole in the first pair and so on. This is indicated on the sketch. The fifth pair will, of course, be in the same position as the first pair, and the sixth pair will be like the second, and so on to the eighth pair.

Four spools of thread, one of each of the chosen colors, should be set on the spool rack or put in a box on the floor. Thread the four threads through the complete pack in the chosen order and proceed with the warping.

When the warping is complete, rearrange the cards in the order shown in the draft and also arrange them so that the lettered holes correspond.

If borders in a solid color are desired with these patterns they must be warped separately.

This warping process takes a number of words to describe, but it is simple enough to do and saves a lot of time.

Diagram No. 2 illustrates two simple “stunts.” The effect sketched on Draft No. 3, and shown in the photograph of woven samples, is suggested for a hatband. For the woven piece shown the warp was of coarse knitting yarn in white, dark blue and orange. To weave, proceed as follows: Weave the little diamond figure in the usual manner by weaving four turns each way. Draw the weft thread tight. Then make twelve turns, all in the same direction, without putting in the cross-thread. This makes twists of each set of four threads. Weave another diamond figure as at first. Make twelve turns without weaving, twisting in the opposite direction from the first set of twists, and proceed in this manner. The effect is unusual and amusing. The same technique might also be used in other materials and for a belt. Any good threading may be used.

Draft No. 4 was used for the piece woven around the square corners. A different threading may, of course, be woven in the same manner.

When ready to turn the corner, weave from left to right, omitting the last four threads; turn the cards and return

Diagram No.1.

Draft No.1
A B C D

1	•	•	■	■
2	•	•	■	■
3	•	•	■	■
4	•	•	■	■
5	•	•	■	■
6	•	•	■	■
7	•	•	■	■
8	•	•	■	■
(8)	•	•	■	■
(7)	•	•	■	■
(6)	•	•	■	■
(5)	•	•	■	■
(4)	•	•	■	■
(3)	•	•	■	■
(2)	•	•	■	■
(1)	•	•	■	■

Draft No.2
A B C D

1	"	X	•	■
2	X	•	■	"
3	•	■	"	X
4	■	"	X	•
5	"	X	•	■
6	X	•	■	"
7	•	■	"	X
8	■	"	X	•
(8)	■	"	X	•
(7)	•	■	"	X
(6)	X	•	■	"
(5)	"	X	•	■
(4)	■	"	X	•
(3)	•	■	"	X
(2)	X	•	■	"
(1)	"	X	•	■

■ Dark
□ Light

" X ■ •
Four Colors

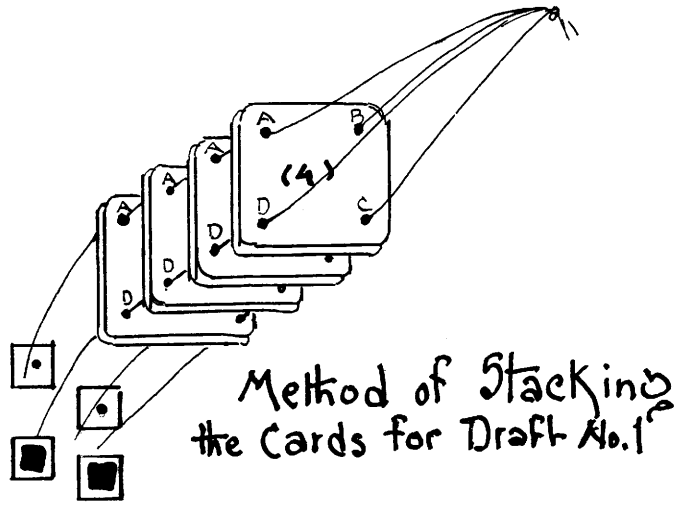

Method of Stacking the Cards for Draft No.1

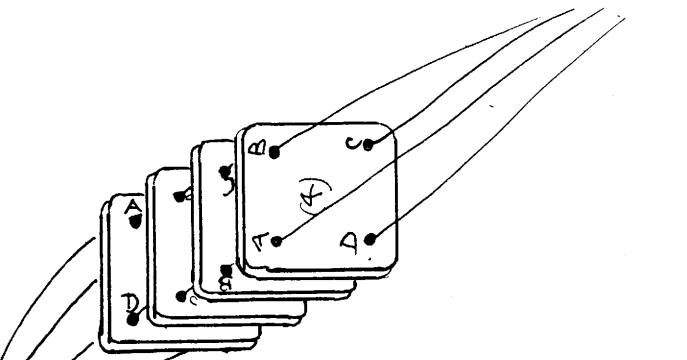

Method of Stacking the cards for Draft No.2

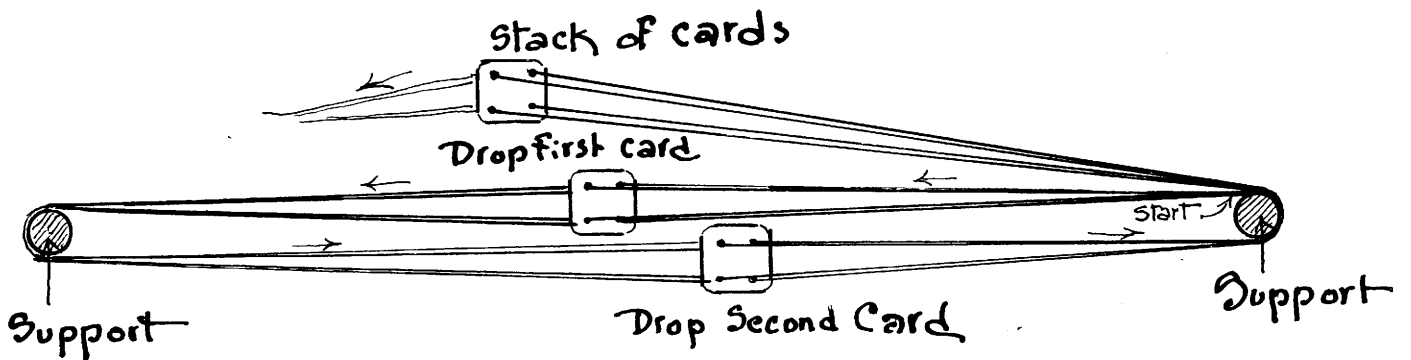

Special Method of Warping.

M.M. Atwater

Diagram No. 2

Draft No. 3

	A	B	C	D
1
2
3	.	.	.	■
4	.	.	.	■
5	.	.	■	■
6	.	.	■	■
7	.	■	■	X
8	.	■	■	X
9	■	■	X	X
10	■	■	X	X
(10)	■	■	X	X
(9)	■	■	X	X
(8)	.	■	■	X
(7)	.	■	■	X
(6)	.	.	■	■
(5)	.	.	■	■
(4)	.	.	.	■
(3)	.	.	.	■
(2)
(1)

- Warp
- 40 threads
 - 28 "
 - X 12 "

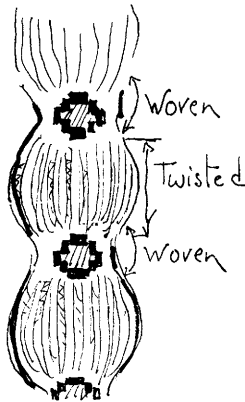

Draft No. 4

1	■	■	■	■
2	■	■	■	■
3	X	X	X	X
4
5
6	X	X	X	X
7	■	■	■	■
8	■	■	■	■
9
10
11	.	■	■	■
12	.	■	■	■
13	.	■	■	X
14	.	■	■	X
(14)	.	■	■	X
(13)	.	■	■	X
(12)	.	■	■	■
(11)	.	■	■	■
(10)
(9)
(8)	■	■	■	■
(7)	■	■	■	■
(6)	X	X	X	X
(5)
(4)
(3)	X	X	X	X
(2)	■	■	■	■
(1)	■	■	■	■

- Warp
- 52 threads
 - X 20 "
 - 40 "

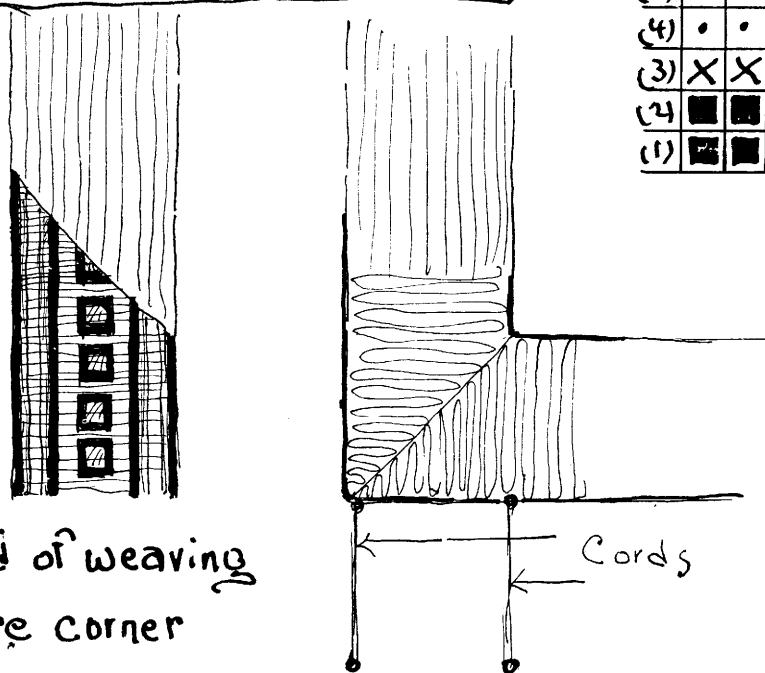

Method of weaving a square corner

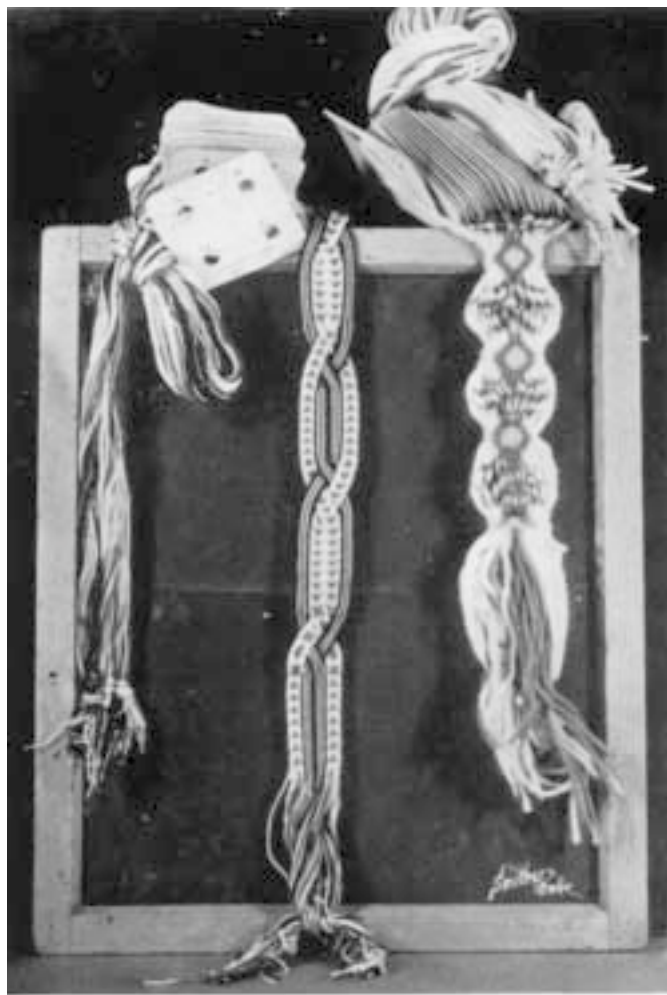

Draft No. 5

Draft No. 3

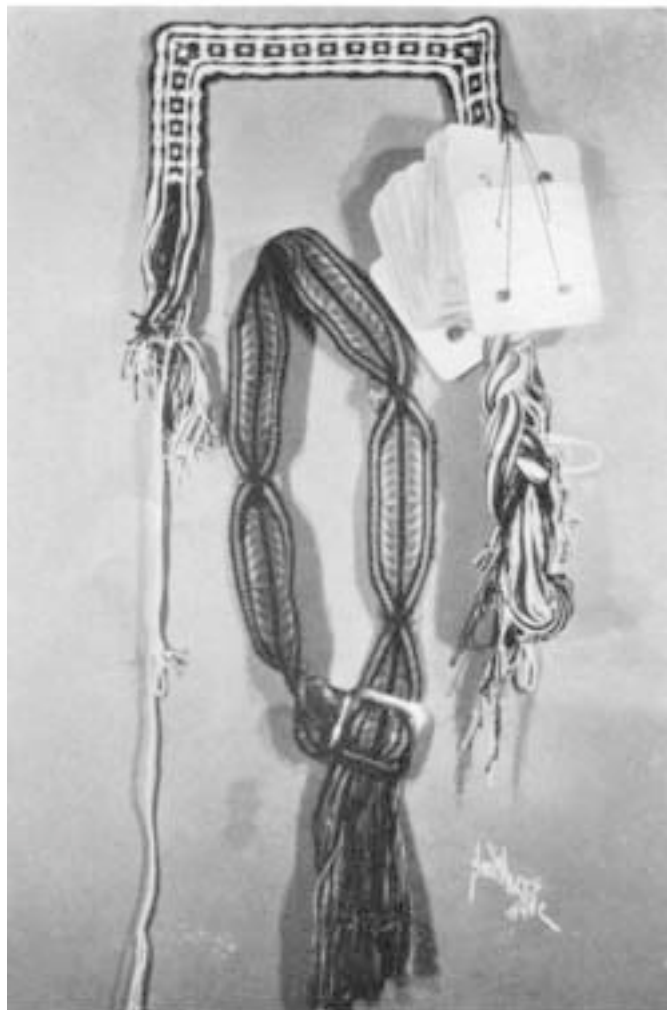

Draft No. 4 (top)

Draft No. 6 Medallion Girdle

from right to left. Weave from left to right, dropping off four more cards, and proceed in this manner till the weaving comes to a point.

Now attach small cords to the woven piece at the point and at a place opposite the start of the slant. Attach these cords to the support as indicated on the sketch. Untie the end of the warp and take up the slack on the right. The warp now runs at right angles to the original direction. Weave, taking up four cards on each shot from left to right till all cards are again weaving together.

Of course any desired pattern may be woven in this manner. The sample piece was done in Perle cotton No. 5 — if finer material is used drop off two cards each time instead of four cards. The slant should run at an angle of 45°.

Diagram No. 3 shows a belt woven in a four-strand braided effect. This is simple and easy to do and has a very striking and novel effect. The sample piece shown on the illustration was done in Perle cotton No. 5, in white, blue and jade. A different pattern and other colors may, of course, be used. The pattern selected, however, should be one that looks well when divided into four equal sections.

The four sections of the warp should be made and tied separately, for convenience in braiding.

Begin by weaving all the cards together for 24 turns. Then weave the four sections separately for 24 turns. Braid the four bands together in the manner indicated on the sketch, which brings the two outside bands to the center, and weave all the cards together for 24 turns.

If preferred, weave the separate bands for 48 turns each and continue the braiding till the bands return to the original arrangement. However, the alternating effect illustrated is perhaps more interesting.

The braiding may be done without untying the end of the warp, until it is difficult to continue the weaving. If each section of warp is tied to a rather long cord the braid can be pushed up into the cords and will not interfere at all with the weaving.

Diagram No. 4 shows a braided effect somewhat different in arrangement. The warp, it will be noted, is in five sections, two of which are wider than the others. The manner of weaving is as follows: Weave all the cards together for the desired distance, now weave the two side bands separately for about three inches. Weave the three middle sections together for some twelve turns; then weave the three middle strands separately for twelve turns each. The band now has the form shown at (a) on the diagram. Cross the two outside bands under the small center band, and secure them in position with a pin, as shown at (b). Now weave the three middle strands together for twelve turns. Join the outside strands, and weave all together for the length desired.

It will be necessary to untie the ends of the warp before rearranging the cards to weave all together, as there is more take-up in the two side bands than in the center bands. The warp for the two side sections should be cut about twelve inches longer than the rest of the warp to allow for this take-up.

The girdle illustrated was made in Perle cotton No. 5, in

THE WEAVER

Diagram No.3

Four-Strand Braided Belt

threading, Draft No.5

	A	B	C	D	
Section 1	1
	2	.	.	+	.
	3	.	+	+	.
	4	+	+	+	.
	5	+	+	+	.
	6	.	.	+	.
	7
	8

- Warp
- Black, 32 ends
 - ⊗ Jade, 16 "
 - White, 56 "
 - + Blue, 24 "

128

Section 2	9	■	■	■	■
	10	■	■	■	■
	11
	12	⊗	⊗	⊗	⊗
	13	⊗	⊗	⊗	⊗
	14
	15	■	■	■	■
	16	■	■	■	■

Weave
All across for 2"
Each section alone
for 2"
Loose the warps and
Cross the strands
as indicated.
Repeat.

Section 3	16	■	■	■	■
	15	■	■	■	■
	14
	13	⊗	⊗	⊗	⊗
	12	⊗	⊗	⊗	⊗
	11
	10	■	■	■	■
	9	■	■	■	■

Section 4	6
	7	.	.	+	.
	6	.	+	+	.
	5	+	+	+	.
	4	+	+	+	.
	3	.	.	+	.
	2
	1

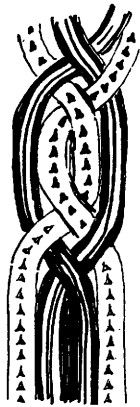

M.M. Atwater

black, red, jade, yellow-green and old gold. Of course other colors and a different pattern might be used. The pattern selected, however, should be one that can be divided into five sections as shown.

These are, of course, only a few of the interesting stunts to which the card-weaving process lends itself. For instance, an interesting fabric is produced by setting card-woven stripes on the loom in an ordinary loom-fabric. The warp

for the card-weaving should be attached to the warp-beam and the ends brought through the reed and tied to the cloth-beam as for ordinary warp. The four threads of each card must, however, be sleyed through the same dent of the reed. Turn the cards and raise the heddles and weave all across with a shuttle in the ordinary way. Usually it is best to weave several shots of weft to each turn of the cards.

A fabric woven in this way makes an interesting bag. The card-weaving may be continued beyond the loom-weaving and forms handles for the bag.

Card-woven fringes are easy to make. Set up a warp on the cards for the width of heading desired. Cut the fringe material in the desired length — an easy way is to wind it over a book of suitable size and cut along one edge. Weave the heading in the ordinary way with a regular weft thread, and lay in the fringe material as desired. If the strands of fringe are tied in a knot at the center these knots will give the effect of a picoted edge when the strands are laid in with the knots along one edge.

A combination of the method shown for Drafts No. 3 and No. 5 would prove interesting: twist for a long way without weaving and braid the twisted strands. Then weave the figure, and repeat. Done in soft wool this would make an interesting and unusual neck-piece.

The technique shown on Diagram No. 3 can be used for straps for sandals: Set up two similar bands of card-weaving, weave first one and then the other with several inches solid, and about two inches with the four sections woven separately. Cross the two bands by braiding the narrow strands together and finish each with several inches woven solid.

For a girdle with long ends, weave in the ordinary manner to within a few inches of the finish. Then separate the warp into three bands and weave these separately for two inches for so — a little longer than the width of the girdle. Do not braid, but simply bring the cards together and weave solid for two or three inches further, — or for as long as desired for the hanging ends. This girdle requires no buckle; simply take one end in and out through the slots in the other end and permit the ends to hang. Long fringes, fancifully braided, add to the effect.

Handles for bags may be made in the manner suggested for sandal straps. Many other ways of using these simple variations of the card-weaving technique will occur to any enterprising card-weaver, I am sure.

(For those unfamiliar with the card-weaving process: A pamphlet of patterns and directions, prepared by Mary M. Atwater, may be obtained of the Emile Bernat and Sons Co. — price \$1.00. Cards for card-weaving are also supplied by the Bernat Company — price \$1.00 per one hundred (plus postage), or \$8.00 per thousand.)

Medallion Belt

Diagram No. 4

Threading, Draft No. 6

		A	B	C	D	Warp		
Section 1	1	■	■	■	■	■ Black	48 ends	
	2	■	■	■	■			
	3	○	+	○	+	⊗ Red	38 "	
	4	X	X	X	X	□ Jade	20 "	
	5	+	○	+	○	+	Gold	20 "
	6	■	■	■	■			
	7	■	■	■	■			
Section 2	8	X	X	X	X	▨ Dk. Green	18 "	
	9	+	+	+	X			
	10	+	+	▨	X			
	11	+	▨	▨	X			
	12	▨	▨	▨	X			
	13	▨	▨	○	X			
	14	▨	○	○	X			
	15	○	○	○	X			
16	X	X	X	X				
Section 3	17	■	■	■	■			
	18	■	■	■	■			
	(16)	■	■	■	■		Center	
	(17)	■	■	■	■			
Section 4	(16)	X	X	X	X			
	(15)	○	○	○	X			
	(14)	▨	○	○	X			
	(13)	▨	▨	○	X			
	(12)	▨	▨	▨	X			
	(11)	+	▨	▨	X			
	(10)	+	+	▨	X			
	(9)	+	+	+	X			
(8)	X	X	X	X				
Section 5	(7)	■	■	■	■			
	(6)	■	■	■	■			
	(5)	○	+	○	+			
	(4)	X	X	X	X			
	(3)	+	○	+	○			
	(2)	■	■	■	■			
	(1)	■	■	■	■			

144 "

Material:
Perle Cotton #5

Weave: All across for 16 turns - all one way.
Sections 1 and 5, separately, for about 2"
Sections 2, 3, and 4, together, for 12 turns; Then separately for 12 turns.
Loose the warp of sections 1, 3 and 5. Cross 1 and 5 under 3 and secure with a pin, as indicated below at (b). Weave 12 turns across the three middle sections. then weave all across for 16 turns.
Reverse, and repeat from the beginning.

Other combinations of colors can, of course, be used in this pattern. Other patterns may be woven in the same manner.

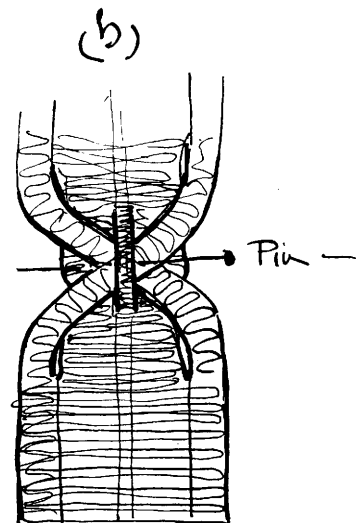
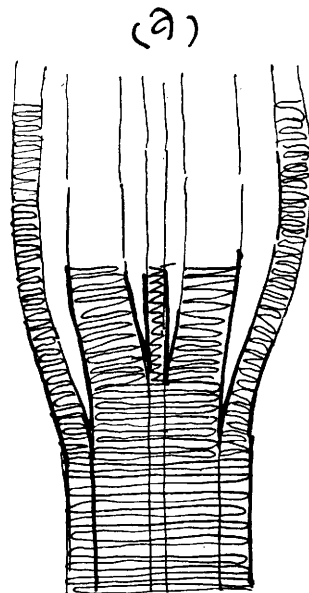

M.M. Atwater

INTERESTING DEVELOPMENTS ON THE "ROSENGANG"

(Continued from page 10)

No. VII

Harnesses

3 & 4 chocolate 1 & 2 bisque	}	4 times (or 8 picks)
2 & 3 chocolate 1 & 4 vanilla		
1 & 2 chocolate 3 & 4 vanilla	}	2 times
1 & 4 chocolate 2 & 3 vanilla		
3 & 4 chocolate 1 & 2 bisque	}	2 times
2 & 3 chocolate 1 & 4 bisque		
3 & 4 chocolate 1 & 2 vanilla	}	4 times
2 & 3 chocolate 1 & 4 vanilla		
1 & 2 chocolate 3 & 4 bisque	}	2 times
1 & 4 chocolate 2 & 3 bisque		
3 & 4 chocolate 1 & 2 bisque	}	2 times
1 & 2 3 & 4		
1 & 2 3 & 4	}	d.b. — 8 picks

THE WEAVINGS OF LOJA SAARINEN

(Continued from page 17)

wood School, Cranbrook, which had been designed by her husband.

Both in structure and in color the room was light and airy as might befit a dining room where young ladies are to eat. The architectural lines of the room are finely articulated, not massive and heavy; the color rose and gray; the dominating notes of the whole, lightness, grace and cheer.

Thus while the wall space called for a wall hanging or tapestry, it had no use for the sumptuous, or imposing. Here was no baronial castle, whose draughty stone walls needed a heavy hanging to keep out the cold air or whose grayness called for the relief of rich color.

Instead here was a well-lighted room in the contemporary spirit, which called for a hanging with a rather light, sheer quality; a slightly rough texture and a suppleness and freshness suited to the room.

Accordingly a combination of weaves was employed to produce a tapestry which should be light and airy, even transparent in some areas, while the pattern as a whole should be graceful and gay, though sufficiently controlled to keep it well within the proper limits of weaving.

This sense of fitness to purpose is characteristic of all of Mrs. Saarinen's work, whether it be the combination of pure silk and heavy gold thread in small handwoven vanity cases and evening bags, or the simple sturdy texture of the curtain fabric for a school girl's room.

THE WEAVER

BABY BLANKETS

(Continued from page 19)

A third stringing for a carriage robe was done in a true basket weave, Draft (b), also taken from the Shuttle-Craft Book. This was made of Bernat's Laurel wool set at 15 threads to the inch and threaded as follows:

5½ repeats of draft in white	77 threads
5½ " in color starting on 8th thrd	77 "
17½ " in white	245 "
5½ " in color	77 "
5½ " in white	77 "
	553 "

Treadled as follows, using great care to keep the weft count 15 shots to the inch and the blocks square: 1, 2, 3, 2, 1, 2, 3, 4, 5, 6, 5, 4, 5, 6.

The weaving should be started in white, weaving 77 shots; then with the colored yarn weave 77 shots. If carefully done and the blocks squared, the large white blocks in the corner will be square. The center of the robe, too, should be square, then reverse the border and the heading.

This robe was bound with a tub taffeta ribbon the same shade as the wool used.

A lap pad on this same stringing proved popular. The heading was woven the same as for a blanket, that is, until the same width as outer white stripe; then weave 7 shots of color; 7 of white, and so on, making about three colored stripes; weave a 9-inch center and reverse stripes. The selvaged edges were bound with the same 2-inch tub taffeta, then the piece was folded through the center, the edges stitched together and later bound with the ribbon, thus making a pocket in which to slip a piece of rubber sheeting, easily removed for washing.

This same material and stringing all in white made an exceedingly nice piece of coast material for the tropics. While there is a long loose-looking thread, it is interwoven in such a way that there is no stretching and sagging as in most loose weaves, and for that reason proved unusually satisfactory for a light weight sports coat.

SCANDINAVIAN ART WEAVING

(Continued from page 24)

two tabby weaves are interlaced, one above the other, where the designs in the fabric meet. The colors on the one side are reversed on the other side of the material. Mrs. Atwater has expertly explained this technique in a *Handicrafter* supplement, Volume VI, Number 1, Part II. Soumak, or Soumak-inlay as it is called by the Scandinavians, is a technique used principally for rugs — and is thoroughly serviceable. Various methods are used in Sweden to introduce the weft into the warp threads. The classical way is to go over four warp threads, back under two, up over four and back under two, and continue this for the width of the weaving or unit of design. The next row is begun in the same way but from the opposite side, making a chain formation in the weft. A tabby is put in after each weft shot.

A few reference books that might interest our weavers are:

"Flamskväv och Finnväv" (Swedish) by Maria Collin, "Skaansk Konstvävnad" (Swedish) by Maria Collin, "Handbok i Vevning" (Norwegian) by Caroline Halvorsen, "Vaevbog for Hjemmene" (Danish) by Jenny la Cour and Johanne Siegumfeldt, "Swenska Textilier" by Nils G. Wollin, "Hemslöjd i Sverige" by Maj Sterner, "Hemslöjd" edited by the National League of the Swedish Society for Home Craft, "Gammel Allmogeslöjd Fran Malmöhus Län" (7 volumes containing many colored illustrations of Röllakan, Flamskväv, Krabba and other techniques), "Finska Ryemöster," and an American book, beautifully illustrated, "European & American Carpets and Rugs" by Cornelia Bateman Farraday.

Now

BERNAT INTRODUCES

SUPERIOR LOOMS



With our years of experience furnishing superior yarn for Weavers, it is but natural that we turned to the manufacture of looms. In presenting Bernat Superior Looms we feel we have taken a real step forward in the world of weaving.

No ordinary looms are "Superior" looms, but instead they are the most advanced models in the market, embodying many new ideas. There are three sizes, each of outstanding merit. You'll want to know about each so we have prepared an illustrated catalogue, which is free upon request. Send for it today and see for yourself how easy it is to use the new Bernat Superior Loom; how because of their collapsible feature they can be stored away in a minimum of space. Bernat Looms, like Bernat yarns, are guaranteed. Prices are reasonable and are illustrated in the catalogue. If you cannot get the Bernat Looms at your dealer, write us.

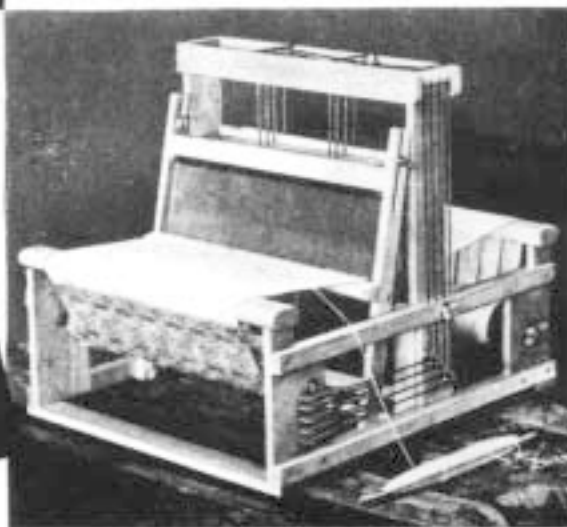

EMILE BERNAT & SONS COMPANY, 99 Bickford Street, Jamaica Plain, Mass.

Makers of Looms and Yarns for Beautiful Weaving