

The Weaver's Journal

\$3.00

Volume V Number 4 Issue 20

Spring 1981

In this issue

Rugs, rugs, rugs

Tapestry

Shaft Switching

Damask

Figure Boundweave

Weft Ikat



SLING BRAIDING OF THE ANDES



ADELE CAHLANDER

WITH ELAYNE ZORN
AND ANN POLLARD ROWE

Weaver's Journal Monograph IV

SLING BRAIDING OF THE ANDES

by Adele Cahlander

with Elayne Zorn & Ann Pollard Rowe

ISBN 0-937452-03-3

Library of Congress Catalog #80-67114

Illustrated with Color
and Black/White Photographs and
with Line Drawings

Published by

Colorado Fiber Center, Inc.

With the help of a grant
from the National Endowment for the Arts

ABOUT THE BOOK

Slings have been used since before the time of David and Goliath. Shepherds used slings to guide their sheep and to protect the sheep from marauding animals. In the Andes, slings took on ceremonial importance as well. Through the years, they were developed into works of art.

How the intricate braids were actually made has long been a mystery. This monograph is the first true documentation on the way the slings were constructed. During field work among the remote highland herders, Elayne Zorn learned the basic techniques on which this book is based. Through the close cooperation of Ann Pollard Rowe and Irene Emery of the Textile Museum in Washington, D.C., a suitable terminology was provided.

Price: \$11.00 Postpaid

Please make checks or money orders, in U.S. funds, payable to: The Weaver's Journal, P.O. Box 2049, Boulder, Colorado 80306 (U.S.A.)

NAME _____

ENCLOSED:

W.J. Monograph IV \$ _____

\$3 extra for other countries if _____

AIR MAIL is desired \$ _____

TOTAL \$ _____

ADDRESS _____

City State or Country Zip



NEW ENGLAND WEAVERS' SEMINAR

July 20 thru July 24, 1981

UNIVERSITY OF MASSACHUSETTS

Keynote Speaker: DR. JUNIUS BIRD

Main Speaker: DINI MOES

Special Interest Groups and Lectures

Swap Sessions Room Shows

AFTER NEWS WORKSHOPS

July 24-28, 1981

Study with: CLOTILDE BARRETT,
DOROTHY BURTON, JANE BUSSE,
TONI KORMOS, CAROL KURTZ, OR
BARBARA WITTENBERG

For complete program brochure and
registration form, write after Feb. 1:

Mrs. Mary Yusko 17 Stanley Rd Norwell, Mass. 02061

MONTE CARLO

100% Combed Cotton, Natural, Unscoured
Appx. 1150 yds/lb • Made in Switzerland



HENRY'S ATTIC
TEXTURED WEFT YARNS
5 Mercury Avenue
Monroe, NY 10950
914-783-3930

Direct Inquiries—Wholesale Only
or inquire
at your favorite weaving shop

Send \$7.50 for
Complete Sample Set

The Weaver's Journal

Quarterly Journal for Textile Craftspeople
Volume V, Number 4, Issue 20 Spring 1981 ISSN #0160-3817

CONTENTS

- 4 **Letter from the Editor**
6 **Workshops**
8 **A Farmer and His Wife, Figure Boundweave**
by Inge Pissowotski
10 **Multiple Shaft Weaving**
Twill and Satin Blocks, Damask
15 **Decorative Weft on a Plain Weave Ground**
Two Shaft Inlay and Brocade
20 **Rug Based on 3-Shaft Straight Twill**
22 **Rag Rugs on Overshot Threading**
by Susan Snover
24 **Shaft Switching on 3-End Drafts**
28 **Modern Overshot (Frappé Moderne)**
Agathe G. Collard
31 **Weft Ikat for Rugs**
by Lydia Van Gelder
35 **Statement of My Ideas**
by Kate O'Callaghan
38 **Three Color Progressions and Their Use in**
Sweater Jackets
by Katherine Sylvan
42 **A Low Budget Tapestry Loom**
by Bill and Sara Gilstrap
44 **Book Reviews**
46 **"Cocoon" Hammock**
by Penelope B. Drooker
48 **From Cotton Patch to Cotton Patches**
and Then Some
by Olive Linder
51 **Product Review**
55 **The Weaver's Market — Classified**

Editor and Publisher—Clotilde Barrett
Associate Editor—Mary Derr
Advertising—Margaret Martin
Photography—Janet Hanley and Earl Barrett
Production—Ellen Champion
Staff Artist—Kay Read

Typeset by WESType Publishing Services, Inc.
Printed by Mountain West Printing and Publishing,
Ltd.
Color separation by Spectrum, Inc.

Our New Loom is for You

(whether weaving is an exciting hobby
or your livelihood.)

We now offer a unique **Modular Loom** that enables you to begin with a basic 4 harness, 6 treadle loom and build to full production capabilities at anytime by adding components.

That's right, add harnesses and treadles to a total of 12 each. Then you can add the A&V programming dobby head and the full 16 harness capability of the loom becomes available—with the use of **just 2 treadles!**

You combine the components to fit **your** needs. From plain weaves to the most intricate patterns, weave with unheard of speed, ease and consistency.

Ahrens & Violette Looms Inc.

Send \$2. for our brochure
601 Orange St. Dept. O17 Chico, CA. 95926

Cover photo: Rug woven on a 3-end block, two-tie draft with shaft-switching by Joseph Durden. The lizard design is based on a free-hand sketch on squared paper. J. Durden used the shaft-switching platform depicted here.

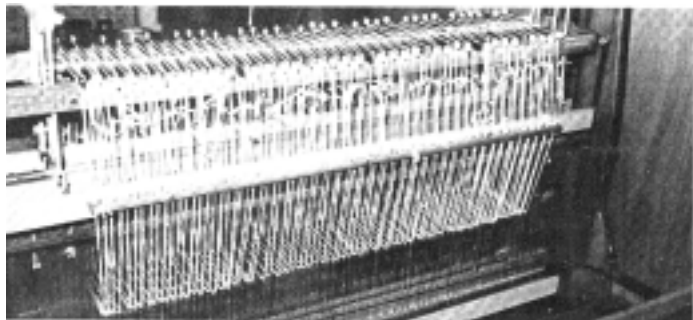

The Weaver's Journal is published on the first of each January, April, July and October by the Colorado Fiber Center, Inc., P.O. Box 2049, Boulder, Colorado 80306. Telephone: (303) 449-1170; 444-2088. Subscription rates are \$12.00 U.S. Currency for 1 year (4 issues) or \$22.00 U.S. Currency for 2 years (8 issues). Colorado residents add 3 1/2% sales tax. Outside U.S.A. - 1 year \$14.00 U.S. Currency, 2 years - \$25.00 U.S. Currency. Copyright Colorado Fiber Center, Inc., 1980. Second-class postage paid at Boulder, Colorado and additional mailing offices. *The Weaver's Journal* USPS 384-210. The editorial committee takes no responsibility for the goods advertised in this journal.



COMPLETE ASSORTMENT OF YARNS

For
*Home Weaving
and
Commercial
Weaving*

SILK • RAYON
WOOL • LINEN
COTTON
NOVELTY YARNS

Hundreds of kinds and
colors to choose from

Orders & inquiries promptly handled

*Send \$1.00 for samples. This small
fee will also bring you free
bulletins and samples from time to
time once we add your name to our
mailing list.*

CONTESSA YARNS

Dept. WJ P.O. Box 37
Lebanon, Connecticut 06249

"Serving handweavers for over 35 years"

Letter from the Editor

It was so gratifying to receive a lot of mail from our subscribers expressing their enthusiasm about the new look of The Weaver's Journal. We got a lot of new subscribers too, for which we are thankful.

With this issue there are some more innovations. One is the direct consequence of entering the computer age. All the drafts from now on will be generated and printed with the aid of an Apple II computer. I think they are neat, easy to read and above all, less time consuming.

The other change is one of vocabulary. Irene Emery from the textile museum in Washington, D.C. and CIETA (Centre International des Textiles Anciens) and others have tried for many years to bring consistency in the weaving vocabulary used throughout the textile world. As a publisher of a scholarly periodical I feel that I can no longer use the word "harness" when the part of the loom that in the U.S. is commonly referred to as "harness" should really be called "shaft". So from now on we all will have to get used to seeing the word "shaft" where we would expect the word "harness". It will require some adjusting to do and there will be some problems. In the product review of this issue for instance, it was hard to decide to use the word shaft when the manufacturer calls his loom a "12-harness" loom.

I am prepared to hear some complaints about this change but I am sure that the positive comments will by far outweigh the negative ones.

Last, but not least, I know that there are a lot of weavers who have made excellent handspun-handwoven projects. We would like to feature such projects in the Fall issue and would really appreciate your contributions. Please send us ideas, photos, samples, comments, questions. I promise you that we will respond gratefully.

Chittelle V. Barrett

THE MANNINGS

HANDWEAVING SCHOOL AND WEAVERS SUPPLY CENTER

HANDWEAVERS —

Weaving Instruction — Resident instruction in all types of weaving. Special classes for beginners. Pre-registration necessary.

Rug Wool — Over 300 colors. 2-3-4-6 ply.

Yarns — Stanley Berrocco — Manos del Uruguay — Indecita (100% Alpaca) — Fawcett Linens — Lily Cottons — Chenilles and many other novelty yarns.

Looms — Gallinger — Leclerc — Dorset in stock for immediate delivery.

HANDSPINNERS —

Spinning Instruction — 1 day course. 9-4 daily. Pre-registration required.

Spinning Supplies — Saxony, Castle and Walking Wool Wheels — Carders — Drop Spindles — Carding Machines — Distaffs.

Fibers — Camel Alpaca-Goat — Angora Rabbit — Yak — Mohair — Flax — Wool Roving — Silk Noil — Tussah Noil — Natural and Dark Fleece.

VEGETABLE DYERS —

Dyestuffs — Mordants — Dyebarks — Lichens — Special Skeined White Wool.

For catalog and rug wool samples, send .50 to:

The Mannings

R. D. 2, EAST BERLIN, PA 17316
(717) 624-2223

IRONSTONE YARNS

FANCY YARNS
from England

- Six Textures
- Eleven Shades

Sample Cards \$3.00

Ironstone Warehouse
P.O. Box 196, Dept. WJ1
Uxbridge, Mass. 01569

MOOD INDIGO?

Go after those **BLUES!**

Send for our special spring dye offer which includes 2 oz. natural Indigo dye, substitute for sodium hydrosulfate and our recipe leaflet. All for only **\$8.00 ppd.** (Illinois residents add 6% sales tax.)

Save even more—double the quantity **\$14.95!**
Offer expires 6/30/81

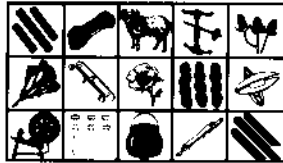

Send \$1 for our catalog of spinning, weaving, and fibre art supplies!

Send check or money order to:

Serendipity Shop
1523 Ellinwood, Dept. W
Des Plaines, IL 60016



PREMIUM FLEECE & MOHAIR
SPINNING & WEAVING SUPPLIES

We are agents for Clemes & Clemes
spinning wheels and Brittany looms

sample book \$2.00

THE WOOL SHED
P.O. BOX 115 209-728-3756
SNEEP RANCH, CA 95250

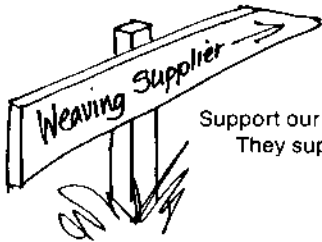

Support our advertisers.
They support us.

JACOB ANGSTADT DESIGNS

Jacob Angstadt
His Weavers Pattern Book

Jacob Angstadt Designs
Drawn from
His Weavers Pattern Book

TWO BOOKS REVEAL 18th CENTURY MASTER WEAVER'S RECORDS

A photographic replica of Jacob Angstadt's pattern book; 307 coverlet and tablecloth drafts; 237 tie-ups for point twill drafts on 6, 8, 12, 16, 20, 24, 28 and 32 shafts. Companion book contains nearly 500 drawdowns from the profile drafts and point twill tie-ups. Designs adaptable to unit weaves on 5 to 10 shafts. Prepared by Ruth N. Holroyd with Ulrike L. Beck.
8 1/2 x 11" Hardbound set totaling 400 pages. \$39.95 per set*

Published & Distributed by:

Ruth N. Holroyd
20 Old Farm Circle
Pittsford, N.Y. 14534 U.S.A.

Add \$1.50 Postage & Packaging \$2.50 Overseas! per set *N.Y. State residents add 7% tax - Dealer inquiries invited









NOW AVAILABLE!

Seminar or Workshop: "Playing with Profiles", Interchanging unit weave systems within multi-harness profiles. Inquire. Ruth N. Holroyd, Instructor

WILDE



WOOLY

-  2, 4 & 6 ply in 8 earthy natural wool colors.
-  natural white wool in various weights and plies.
-  3 & 4 ply wooly Berber yarns in 5 rustic colors.
-  sturdy 3 ply wool in 15 subtle shades.
-  fine 2 ply wool for warp or weft in 28 custom dyed colors.
-  the Heavyweight—a bulky wool yarn in 9 bold colors.
-  carded wool in white and natural colors.
-  carded wool in 8 dyed colors.

Send \$2.00 for sample cards.

WILDE® YARNS

for HANDWEAVING

Custom Spun by
John Wilde & Brother, Inc.
3705 Main Street, Dept. W
Philadelphia, PA 19127

A Tradition in Spinning Since 1880

WORKSHOPS



ANDERSON RANCH ARTS CENTER
BOX 2410 ASPEN, COLORADO 81612 (303) 923 3181

SUMMER WORKSHOPS

Guatemalan Master Weaver

Rachel Brown

Weaving, Spinning & Dyeing

Madelyn Johannes &

Luisa Gelenter

Natural Dyeing

Kristina Wilson

Rug & Tapestry

Joy Stanford

Basketry

Sas Colby

Creativity as Play

Call or write for brochure



1981 SUMMER WORKSHOPS

June 8-12, 15-19

July 13-17, 20-24

August 3-7, 10-14

Beginning • Intermediate •
Advanced

Special — Dobby —
Drawloom

Advanced registration necessary
Write or Call —

The Weaver's Shop & Yarn Co.

39 Courtland Dept. WJ

Rockford, MI 49341

Phone: (616) 866-9529

FLETCHER FARM

Vermont's oldest resident

CRAFT SCHOOL



ENJOY A LEARNING VACATION

in a

RELAXING RURAL ATMOSPHERE

- * summer weekly sessions
- * mini workshops
- * family weekends
- * spring - fall workshops

For details & information

write to



FLETCHER FARM
CRAFT SCHOOL
LUDLOW, VERMONT 05149

Tel. (802) 228-8770

(after June 1)

14th ANNUAL SPINNING SEMINAR

Saturday, June 13, 1981, 9 A.M. to 4 P.M.

*Vegetable Dyeing of All Types of Fibers

*All Types of Spinning

*Sheep Shearing and Grading

*Flax Scutching

*Silk Worms and Their Culture

Continuous demonstrations plus special lectures

SPECIAL JUNE WORKSHOPS

Wednesday, Thursday, Friday, June 10, 11, 12, 1981

Weaving With Your Handspun - Bro. Kim Malloy, O.S.B.
St. Meinrad, IN

White Oak Market Baskets - Juanita Wolfe
Cherokee, NC

For more information regarding these events, write:

The Mannings

R. D. 2, East Berlin, PA 17316

(717) 624-2223



"a happy marriage—"

That's how a student-customer described her experience here at Sievers.

Excellent, high quality Sievers looms and spinning wheels and the most rewarding instruction you could imagine—a 'marriage' if you will. This summer there will be over thirty courses taught by twenty two qualified teachers.

If you want the best in proven equipment or if you need pleasant, warm guidance, then be sure to write for all the information—it's free.

**SIEVERS LOOMS, SPINNING WHEELS and
SCHOOL OF FIBER ARTS**

Walnut St. Washington Island, WI 54246

Happiness is in Your Hands—and it Keeps You Young!

You asked for

You've been wanting an exciting, contemporary magazine filled with a wide range of interesting, challenging projects using yarns and fabrics.

And you've wanted creative suggestions for altering the project to fit your personal needs and tastes.

and here they are . . .

You've wanted pre-tested, detailed and easy-to-follow instructions.



Fiber Designs handmade



Welcome to **handmade/Fiber Designs Magazine**. *Your* magazine. Each lavishly photographed issue, at only \$12 a year, gives you:

- Scores of projects and ideas on a single theme—such as Rugs, Wearables or Home Accessories.
- Lots of the really useful information you want: how difficult the project will be, how much yarn you'll need, how long the project will take—even a variety of easy-to-find yarns you can use.
- Information on how you can alter the project to make it just right for you—whether it's an informal rug, an elegant coat or a traditional blanket.
- Detailed photography to guide you through those tricky points that make the project turn out just right.
- Insightful, carefully written tips and hints on a myriad of fiber techniques.
- A variety of projects and ideas at all skill levels—from easy, one evening projects to heirloom quality projects—even ideas for groups, students and children.
- Some of America's finest and best-known designers will give you projects that are elegant, expressive, contemporary and creative.
- Each issue will include special sections like *Craft Techniques*, which introduce you to new—and old—ways to expand your creativity, and *Notebook*, filled with useful, money-saving ideas.
- Beautifully designed and professionally photographed, each issue will bring you the ideas, the techniques and the information to fit you and your lifestyle.

It's what you've asked for: **high quality pre-tested projects designed by experts, with ideas and suggestions to make them come out right—and beautiful—the first time.**

handmade/Fiber Designs, 50 College St., Asheville, NC 28801

Please allow 6-8 weeks delivery for your **handmade/Fiber Designs Magazine**.

INSIDE THE PREMIER ISSUE

WEARABLES

Guest Edited by Virginia West

You'll find beautiful designs and projects for coats, sweaters, tunics, vests, dresses, skirts, jackets, and more. All with detailed instructions, handsome photographs and creative, useful suggestions.

This issue is yours as a Charter Subscriber.

CHARTER SUBSCRIPTION FORM

Send to: **handmade/Fiber Designs, 50 College St., Asheville, NC 28801**

Yes, I want to be a Charter Subscriber to **handmade/Fiber Designs**. I've enclosed my payment. I understand that if I'm ever dissatisfied, I'll let you know and you'll refund my money for the unsent issues.

1 year (4 issues) \$12 2 years (8 issues) \$22

Check enclosed Charge my VISA Mastercharge
Card No. _____ Exp. _____

Name _____

Address _____

_____ Zip _____

*Canadians, add \$2 per year; Other Foreign, add \$6 per year.
ALL PAYMENT MUST BE IN U.S. FUNDS.* W.11



A FARMER AND HIS WIFE

FIGURE BOUNDWEAVE

by Inge Pissowotski

Once upon a summer day, I was sitting outside with my 15" (31 cm) table loom, threaded with my favorite boundweave threading. I wanted to weave a small wallhanging to give to my friends at the Serendipity Shop, Des Plaines, Illinois. I decided that the wallhanging had to deal with

spinning, weaving and dyeing. I put my brain in gear, reached for graph paper and pencil and designed a story.

Once there were a farmer and his wife, raising sheep. Once a year the sheep needed shearing and what should they do

with all that wool? Why spin it, of course—on a drop spindle. With all the plant life on the farm, they found flowers, suitable for dyeing the handspun yarn. After all that work, the farmer's wife could finally fill the bobbin, insert it in the shuttle, and then, I'm sure, she wove a bog-shirt for her husband.

WARP: 5/2 cotton

WEFT: Berga-Ullman Mohair/Wool or 7/2 CUM

SETT: 10 epi (40/10 cm) in 10 dent reed

THREADING:

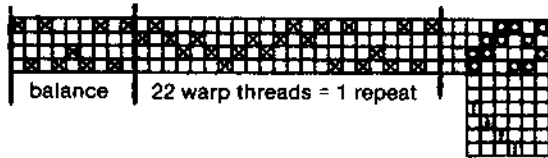

TREADLING: Always tr 1, tr 2, tr 3, tr 4. Treadling one sequence 1, 2, 3, 4 equals one row. You need to weave 3 rows [(1,2,3,4) 3 times] to square the design. The treadling is always the same, it's the selection of color that makes the design.

Note: Your selvages will not be good and you need floating selvages.

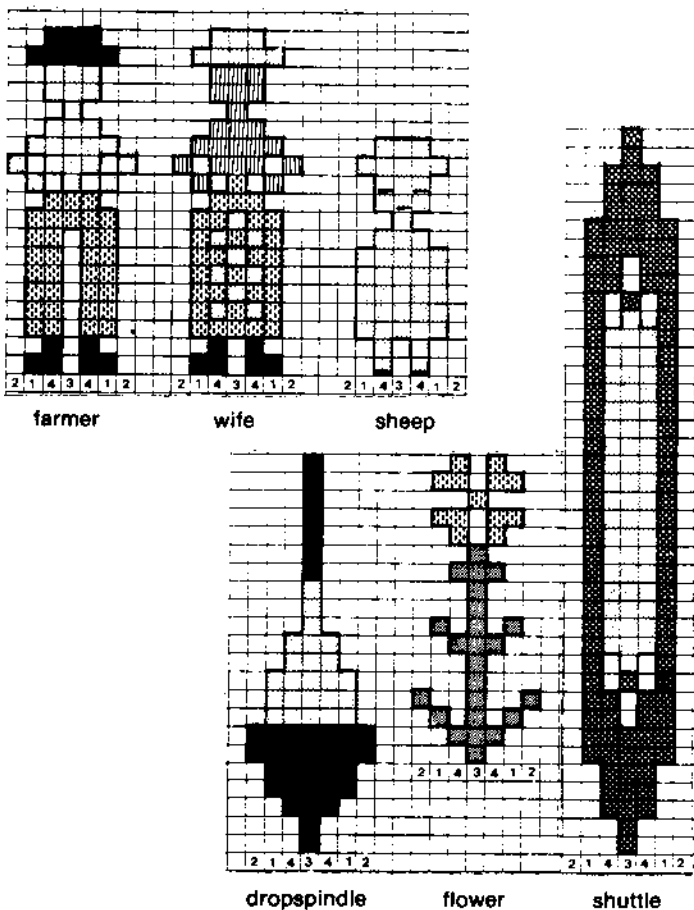

Example: to weave this flower in blue □, red ■, green ◻ on grey □ background. Starting from the top:

tr 1 — grey
tr 2 — grey
tr 3 — grey
tr 4 — blue

do this 3 times to square the design

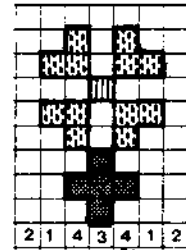

tr 1 — blue
tr 2 — grey
tr 3 — grey
tr 4 — blue

3 times

tr 1 — grey
tr 2 — grey
tr 3 — red
tr 4 — grey

3 times

tr 1 — blue
tr 2 — grey
tr 3 — grey
tr 4 — blue

3 times

tr 1 — grey
tr 2 — grey
tr 3 — grey
tr 4 — blue

3 times

tr 1 — grey
tr 2 — grey
tr 3 — green
tr 4 — grey

3 times

tr 1 — grey
tr 2 — grey
tr 3 — green
tr 4 — green

3 times

tr 1 — grey
tr 2 — grey
tr 3 — green
tr 4 — grey

3 times

As you can see, boundweaving is very slow and requires a lot of weft. Be sure and use a softly-spun weft yarn, so it will pack well.

References

- Evans, Jane, Boundweave, *The Weaver's Journal*, Vol. I, No. 4, April 1977.
- Black, May, "New Key to Weaving", Bruce Publishing Co., 1957.
- Regensteiner, Else, "The Art of Weaving", Van Nostrand Reinhold, 1970.

MULTIPLE SHAFT WEAVING

TWILL AND SATIN BLOCKS, DAMASK

Twill blocks are an extension of straight twill. The theory of twill blocks has great design applications for the multiple shaft weaver and is basic to the understanding of damask. The ground twills most frequently used are $\frac{1}{2}$ (3-shaft twill), $\frac{1}{3}$ (4-shaft twill), $\frac{1}{4}$ (5-shaft twill), and $\frac{1}{7}$ (8-shaft twill). These twills (or satins) are called the groundweave.

Designing with twill blocks is done by setting off areas of weft-twill (or weft-satin) against areas of warp-twill (or warp-satin). The arrangement of the blocks is referred to as pattern.

Most twill block weaves are about 50:50, that is as many ends per inch as picks per inch. However, this is not a fast rule and twill blocks can be woven weft face and be used in rugs.

In order for the design to stand out, it is important that the junction between two adjacent blocks is clean cut. There has to be a break of the warp floats and of the weft floats at the junction, thus no floats crossing over from one block to the other. See Fig. 1. This factor depends on the tie-up and or on the treadling. The cases where the clean-cut junctions are impossible to achieve will be discussed.



1. 8-shaft fabric based on twill blocks. Woven by Barbara Knollenberg

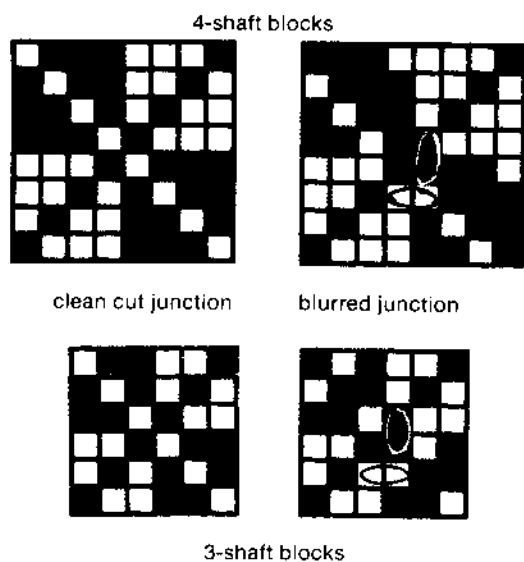

FIGURE 1. Draw downs in which ■ indicates a riser, that is where the the warp is lifted on top of the weft

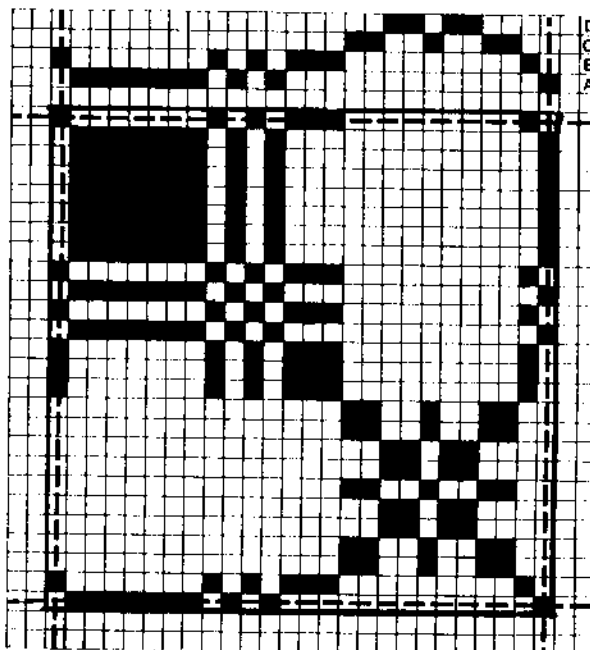

FIGURE 2. One quarter of a 4-block pattern + block draft

THREE-SHAFT GROUND WEAVE

The three shaft twill gives the handweaver with 12 shafts the opportunity to weave four-block patterns such as the one shown in Fig. 2

Fig. 3 shows a two-block 3-shaft twill. Notice that in Fig. 3a the warp twill and the weft twill run in opposite directions, and that there is a clean cut between the blocks. In Fig. 3b, both twills are made to run in the same direction and a clean cut is impossible at all the junctions. Fig. 3b is the weave structure used for drawloom patterning.

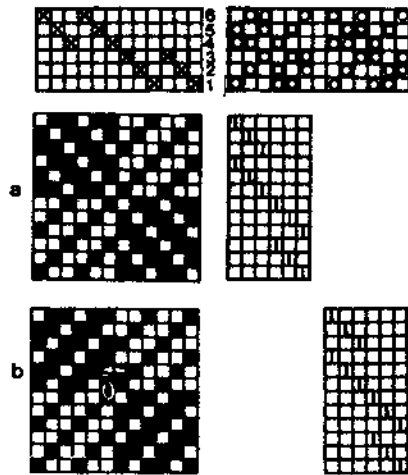

FIGURE 3

Fig. 4 are **short drafts** for the threading and tie-up. Fig. 4a is the 2-block pattern shown in Fig. 3a; Fig. 4b is the 4-block pattern shown in Fig. 2.

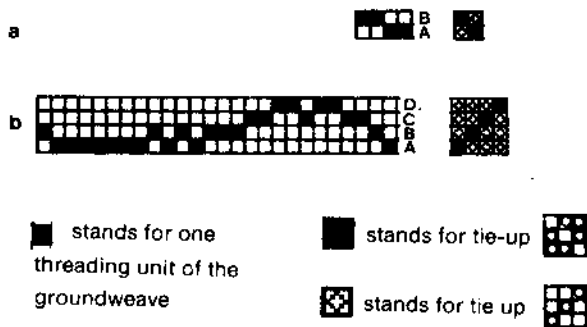

FIGURE 4

FOUR-SHAFT GROUND WEAVES

Fig. 5 shows a two-block 4-shaft twill in which a $\frac{3}{1}$ twill is set off against a $\frac{1}{3}$ twill. Fig. 5a shows the twills running in opposite directions with blocks having clean cut junctions. This weave is sometimes referred to as Dornick. Fig. 5b shows twill blocks with *broken* twill treadling. The binding points are more scattered around and the blocks have clean cut junctions. This weave is sometimes referred to as false damask. The sample shown is woven with Frost-tone (Lily) sett at 20 epi (80/10 cm); *a* shows twill blocks, *b* shows false damask.

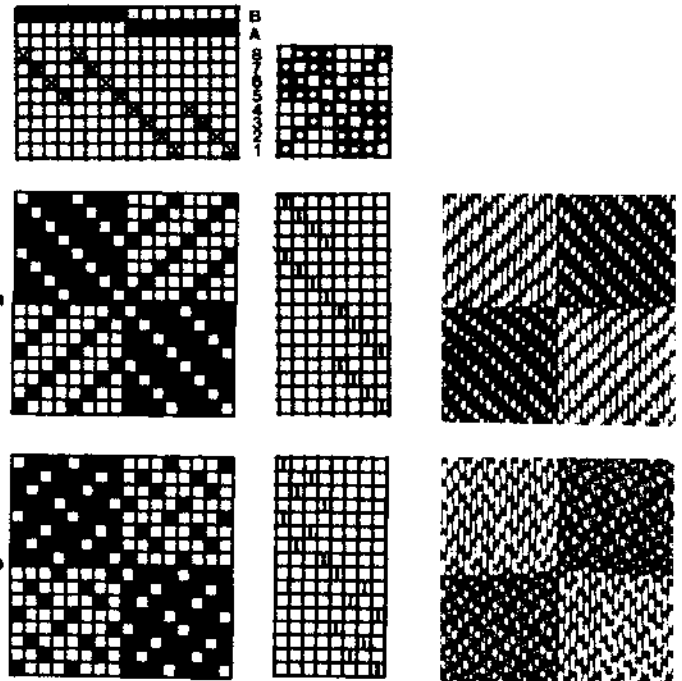
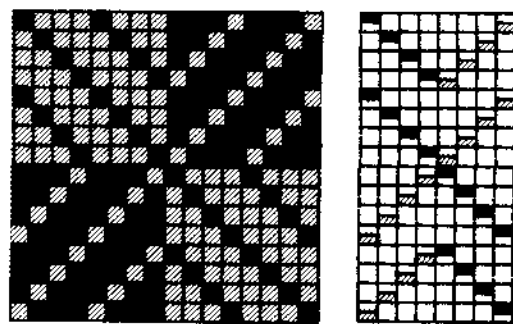
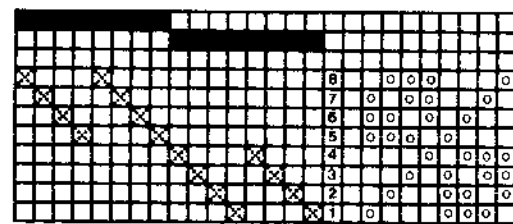

FIGURE 5

2. Sample of twill blocks

RUGS BASED ON FOUR-SHAFT TWILL BLOCKS

The threading and tie-up of Fig. 5 or 6 can be used for weft-face block patterning. The warp should be sett far apart and will be covered entirely by the weft. This type of fabric is woven with two shuttles carrying the wefts ■ and ▨ and is treadled "on opposites". Two opposite picks are required to weave one row of fabric. See Fig. 6.



■ > weft color showing on the face of the cloth
▨ > weft color showing on the face of the cloth

FIGURE 6

The saddleblanket shown here was woven with a woolen warp sett at 5 epi (20/10 cm). The 3-block pattern was threaded on 12 shafts.

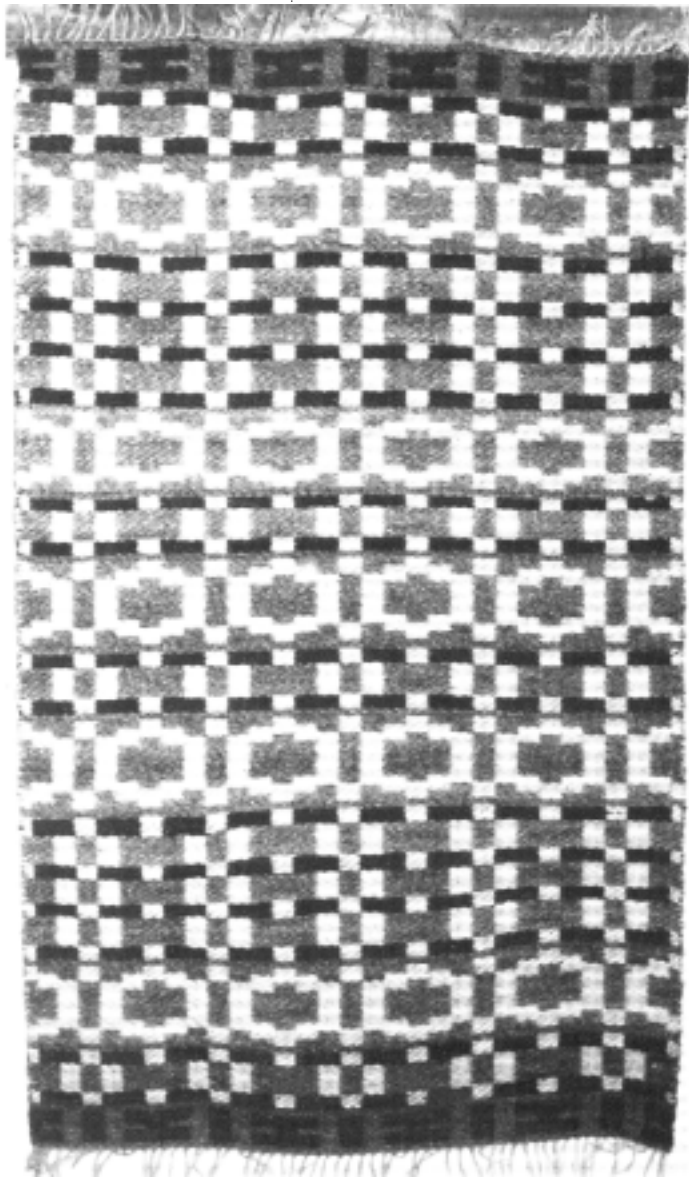

3. Saddleblanket with three 4-shaft twill blocks

FIVE-SHAFT GROUNDWEAVES: TWILLS AND SATINS

Fig. 7 shows a two-block 5-shaft twill and satin. Notice that the satin ground is woven here with a twill tie-up and a broken (satin) treadling.

Fig. 8a shows the same satin blocks as Fig. 7b, this time with a satin tie-up and a twill treadling.

Fig. 8b shows the weave structure of 5-shaft block satin for drawloom patterns. Note that in this case the junctions of the blocks are not clean-cut.

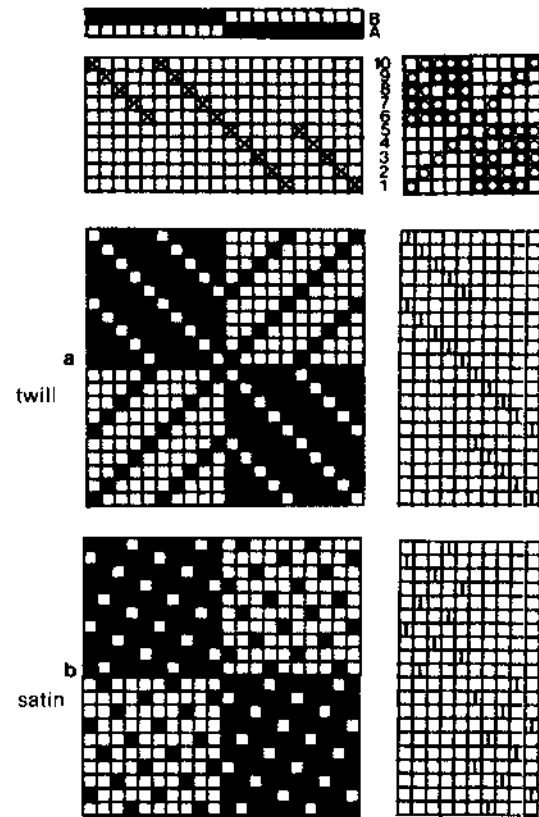

FIGURE 7

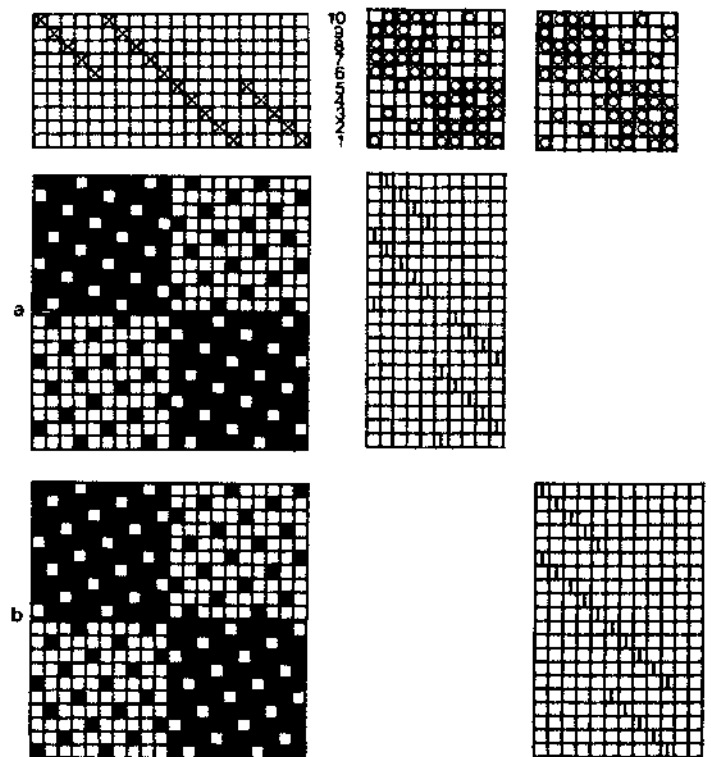

FIGURE 8

EIGHT-SHAFT GROUNDWEAVE: TWILLS AND SATINS

Fig. 9 shows two blocks of 8-shaft twill and satin.

Fig. 9b shows the weave structure of 8-shaft block satin for drawloom patterning. This is the first satin groundweave we have encountered that can be used for drawloom patterning and which also has clean-cut junctions between the blocks.

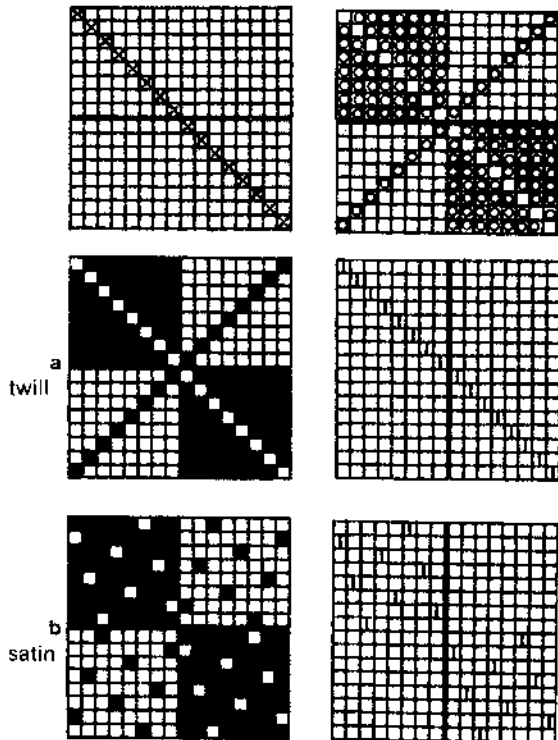

FIGURE 9

Photos—Courtesy of Glimåkra Looms and Yarns



4. View of the Glimåkra damask draw loom showing some of the pattern shafts pulled up with a draw cord

THE DRAWLOOM

Among the many pattern weaves that a drawloom can do with great efficiency, the twill and satin block weaves are perhaps the most important.

The drawloom has two harnesses. See Fig. 10.

The **pattern harness** is in the back. The shafts carry normal-eye heddles and are threaded according to the short draft. In the short draft, each square represents as many warp threads as needed for one unit of the groundweave. The threads of one unit may be threaded through the same heddle. For example, if one wants to weave the pattern of Fig. 2 with a 3-shaft twill ground on a drawloom, four pattern shafts are needed and are threaded according to the profile draft shown in Fig. 4.

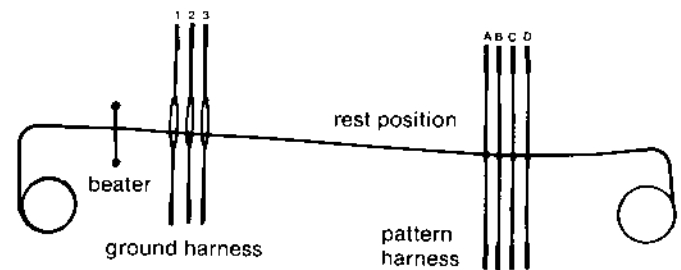
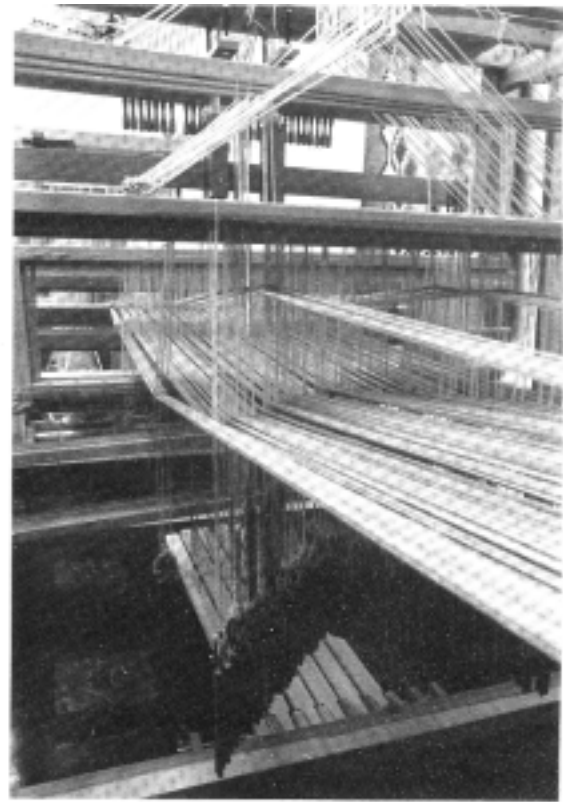

FIGURE 10



5. View from the rear showing some pattern shafts up. The ground harness with the long eyed heddles can be seen between the pattern harness and the beater.

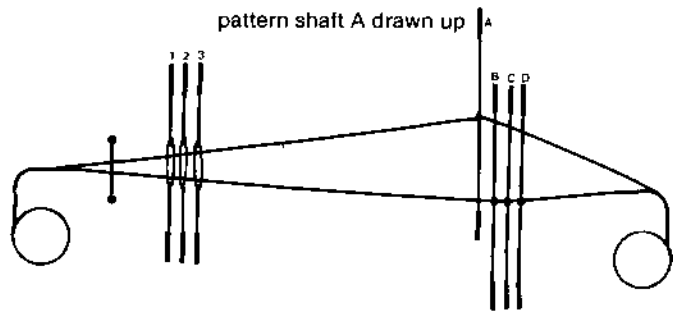

FIGURE 12

All the warp ends are consequently threaded through the shafts of the ground harness. See Fig. 11. These shafts have long-eyed heddles; long enough so that a shed can be formed inside the eye.

To start weaving the pattern with warp-twill in A and weft-twill in B, C and D, lift shaft A (by pulling on a cord which is held in place in a notch in front of the weaver). The three ends of each A unit will be in the up position inside the eyes of their respective heddles 1, 2 and 3. See Fig. 12

In order to get the correct weaving shed, the ground shafts have to be able to rise and to sink. Therefore, it is necessary to have a counterbalance or countermarch loom. The countermarch is best suited for the drawloom.

For the first weft pick, shaft 1 has to rise in blocks B, C and D (weft-face twill). This will not affect the A block in which all the threads are already up. At the same time shaft 2 has to be lowered in the A block (warp-face twill). This will not affect B, C or D in which shaft 2 is already down. The shed is now correct for the fabric structure of Fig. 3b. See Fig. 13.

The abbreviated tie-up for the three weft picks of 3 harness blockweaves on the drawloom is shown in Fig. 14.



FIGURE 14



is the tie-up for the weave structure of Fig. 5a or 5b and of Fig. 6.



is the tie-up for the weave structure of Fig. 8b.

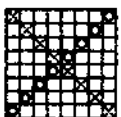

is the tie-up for the weave structure of Fig. 9

It is not possible to tie up a countermarch loom to produce the weave structure of Fig. 3a or Fig. 7; therefore, these weaves are not suited for the drawloom. ■

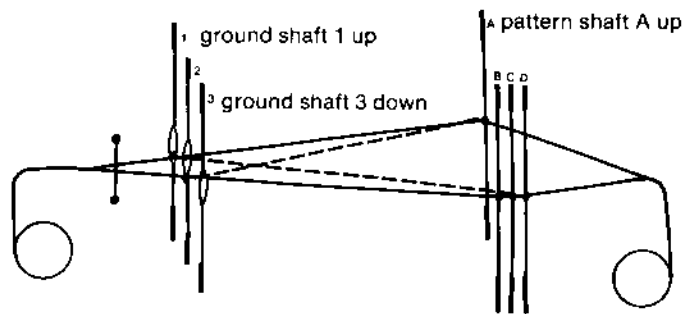

FIGURE 13

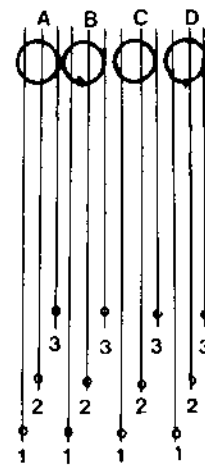
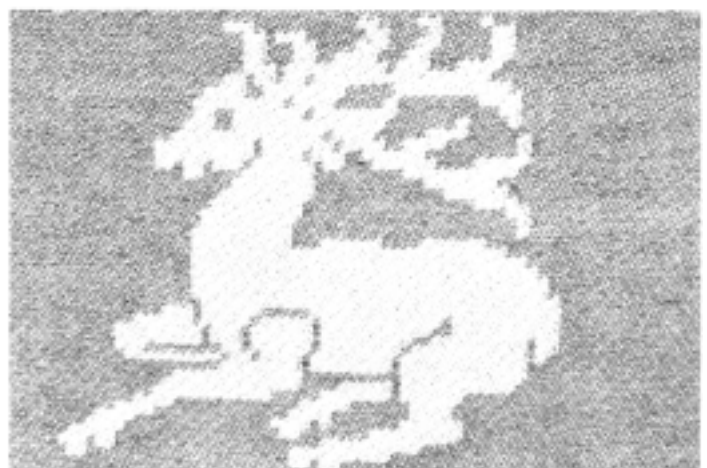
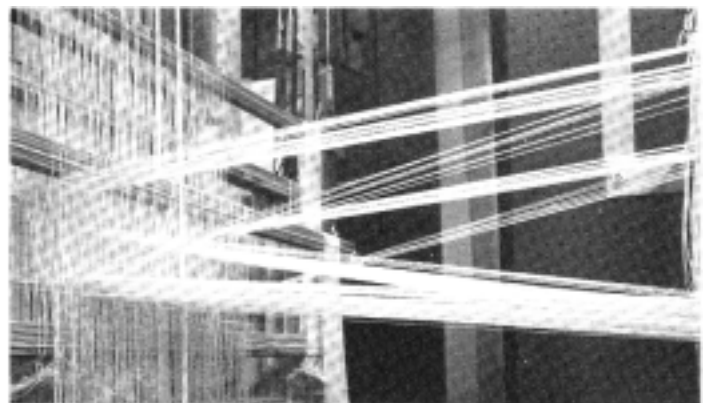

FIGURE 11

Photos — Courtesy of Glimåkra Looms and Yarns

6. Between the pattern harness (right) and the ground harness (left), there is a crisscrossing on the warp threads when ground shafts have been lifted and sunk by means of treadles.

7. 5-harness damask done on a figure harness damask loom in which the units of groundweave are not threaded on harnesses but can be individually controlled by drawstrings.



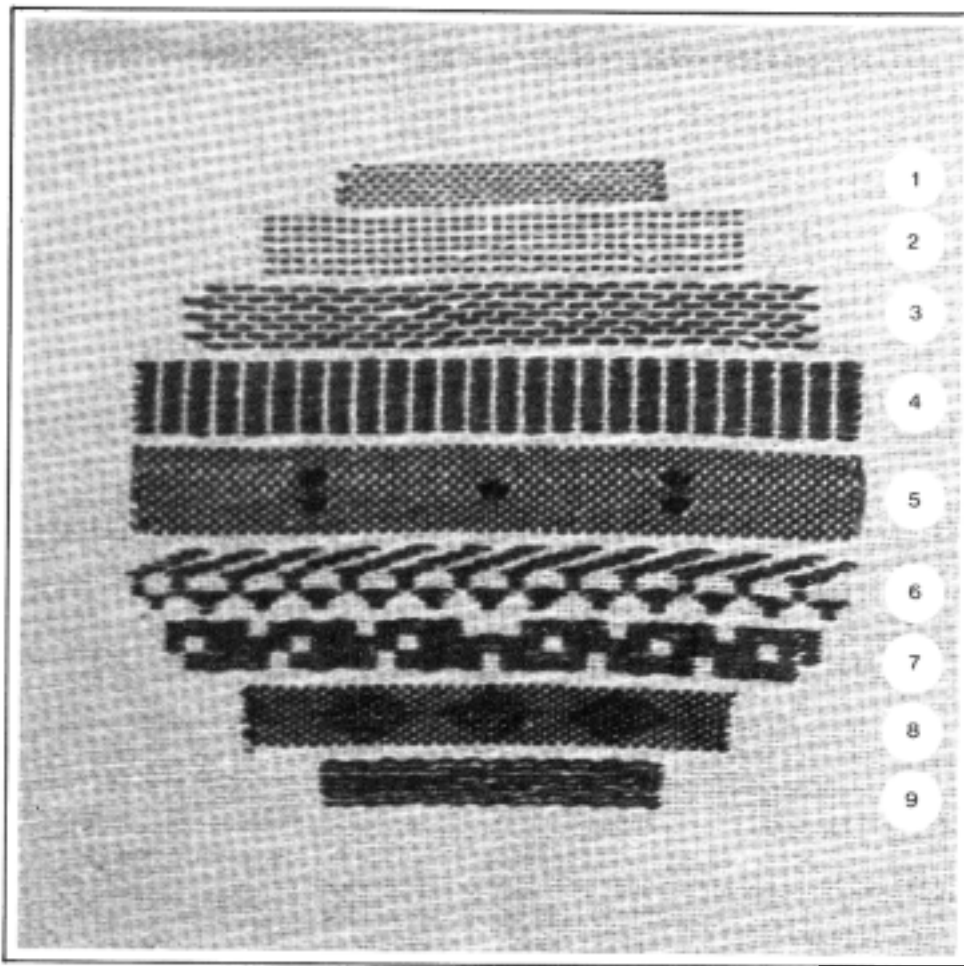

1.—Inlay sample woven by Willy Bottema

DECORATIVE WEFT ON A PLAIN WEAVE GROUND

TWO SHAFT INLAY AND BROCADE

This article deals with decorative weft laid in a shed that is picked up by hand and/or laid in a relatively small area of the shed according to patterns designed by the weaver. Two weft yarns are used. The ground weft interlaces with the warp in plain weave throughout the entire fabric. The decorative weft interlaces in a variety of ways which will be the subject of this study.

If the decorative weft passes through the shed from selvedge to selvedge the technique is called brocade. If the decorative weft is laid in only a portion of the shed, the technique is called inlay. The inlay weft turns at the edge

of the design and makes floats at the edge of the design. If those floats are not desirable, as is true in most cases, the decorative weft has to be passed through the warp at the edge of the design and remain underneath the fabric until the next inlay pick has to be made. An alternative that is frequently used is to weave inlaid fabric wrong side up.

In order to familiarize oneself with the many inlay techniques, it is best to make a sampler with very simple designs such as rectangles. An example is shown in Plate 1.

Throughout the text, sheds *a* and *b* will refer to the plain weave sheds.

1. Supplementary weft in each plain weave shed.

The design is drawn on graph paper. See Fig. 2. Open shed *a* and weave the ground weft. In the same shed, lay the decorative weft according to the first row of the design diagram. Open shed *b* and weave the ground weft. In the same shed, lay the decorative weft according to the second row of the diagram.

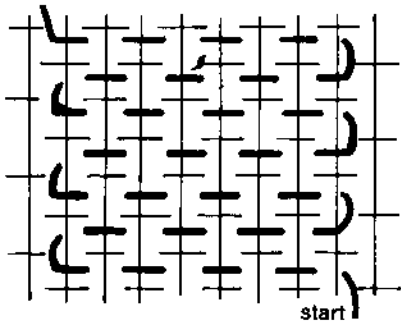

Figure 1.—Interlacement of fabric

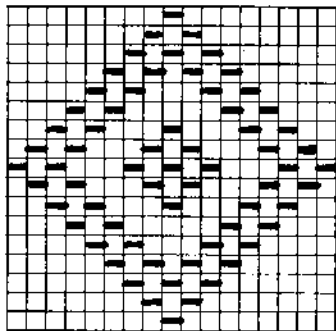

Figure 2.—Design—1 square for each warp end

2. Supplementary weft in every other shed.

The design is drawn on graph paper. See Fig. 4. Open shed *a* and weave the ground weft. In the same shed, lay the decorative weft according to the first row of the design diagram. Change to shed *b* and weave the ground weft. Repeat these two steps for each row of the design diagram.

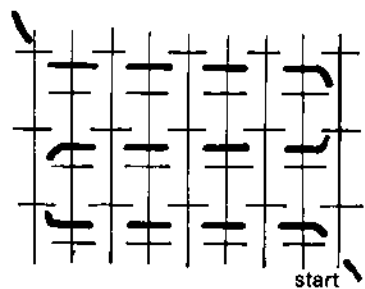

Figure 3.—Interlacement of fabric

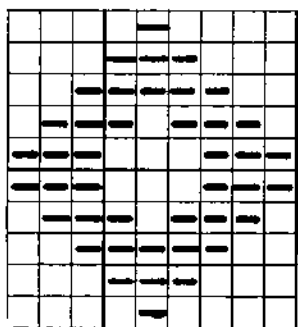

Figure 4.—Design—1 square per two warp ends



2.—Inlaid tapestry woven by Ellen Champion

3. Supplementary weft floats over three and under one warp end.

The design is drawn on graph paper. See Fig. 6. Weave two picks of ground weft. Pick up a shed by picking up every fourth warp end and lay the decorative weft in the shed according to the design diagram. Weave two more picks of ground weft. Pick up a shed by picking up every fourth warp end in such a way that this picked up shed alternates with the previous one. Lay the decorative weft in this shed to finish the first row of the design diagram.

It is easier to pick up every fourth warp end when the second plain weave shed is kept open. Pick up every other raised warp end for the first pick-up shed and pick up the alternate raised warp ends for the second pick-up shed.

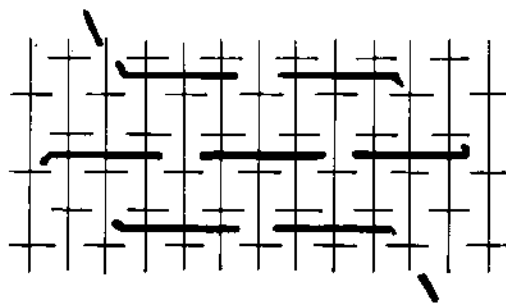

Figure 5.—Interlacement of fabric

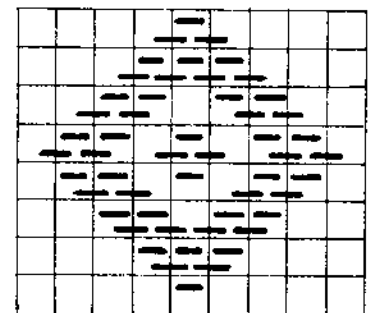
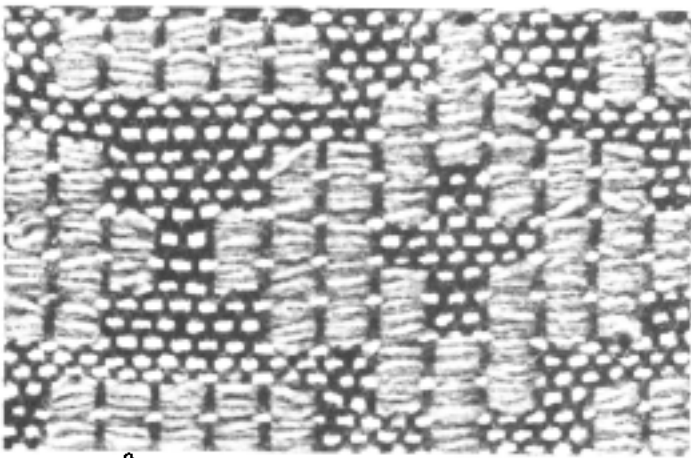

Figure 6.—Design—1 square per 4 warp ends



3. *Dukagang*

4. Dukagang—supplementary weft floats over 3 and under 1 warp end.

The design is drawn on graph paper. See Fig. 8. Open shed *a* and weave the ground weft. Pick up a shed by picking up every fourth warp end and lay the decorative weft in this shed according to the first row of the design diagram. Open shed *b* and weave the ground weft. Pick up the same shed as for the previous inlay and weave as before.

Repeat the complete sequence, then follow these same steps for the next rows of the design diagram. Note that after they are woven the decorative wefts group together in pairs.

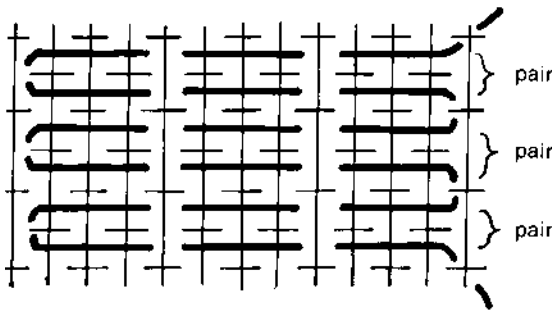

Figure 7.—Interlacement of fabric

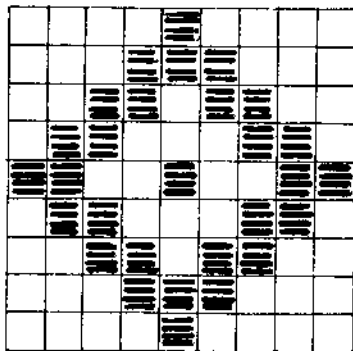

Figure 8.—Design—1 square per 4 warp ends

5. Inlaid spots.

The design is made up by the arrangement of the spots and their variation in size. Between two picks of ground weave, the decorative weft is woven back and forth in plain weave over a few adjacent warp ends to make a spot. On the sampler, the ground weft for this technique is a dark yarn.

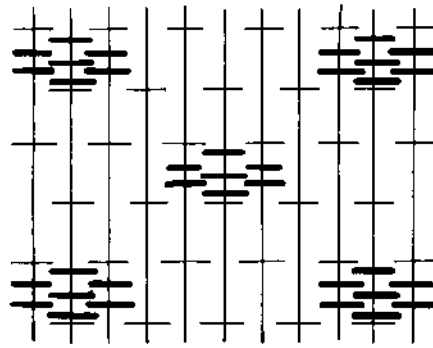
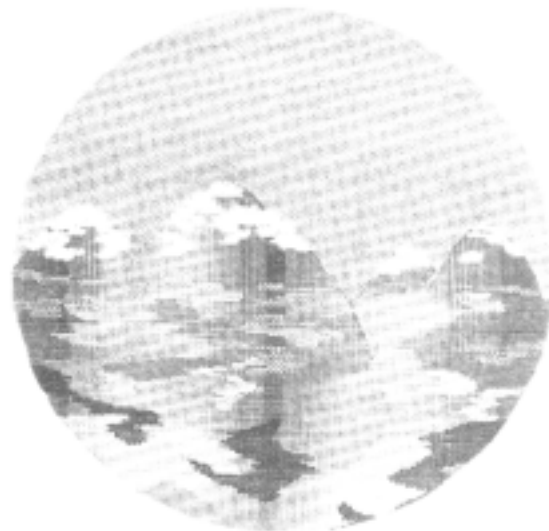

Figure 9.—Interlacement of fabric



Figure 10.—Design of spots. One spot covers several warp ends depending on the size of the spot.



4.—Inlaid tapestry woven by Clotilde Barrett



5.—Detail of Plate 4

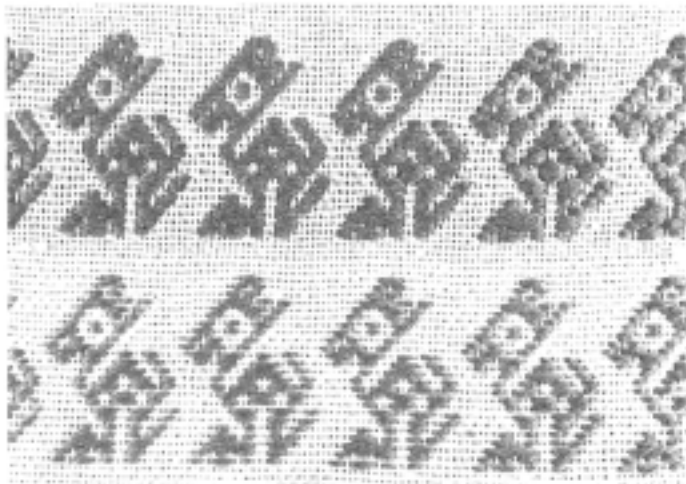

6.—Brocade in technique of loom embroidery

6. Loom embroidery

The design is drawn on graph paper, Fig. 12. The supplementary weft may make floats that vary in length as long as they are consistent with the use of the fabric.

After each pick of ground weft the inlay shed is picked up by referring to a row of the design diagram. The warp ends corresponding to the blank squares are picked up. The decorative weft is passed through that shed.

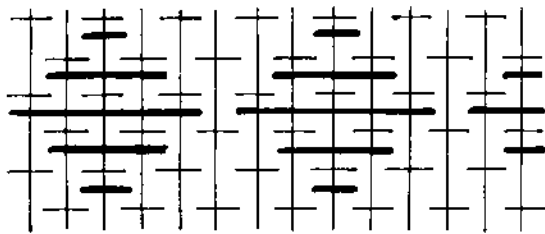

Figure 11.—Interlacement of fabric

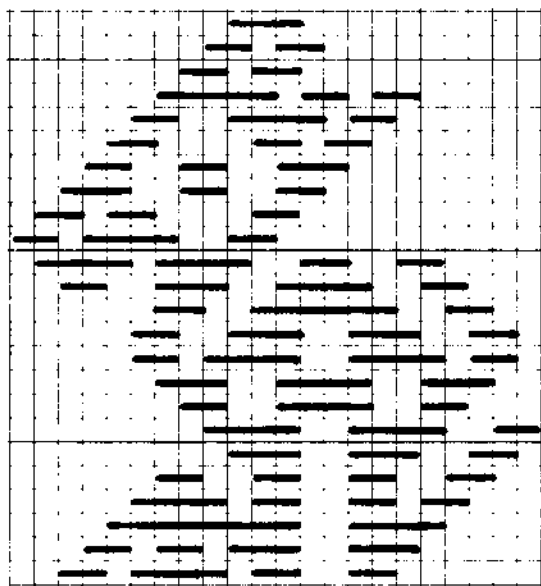

Figure 12.—Design (Peruvian)—One square for each warp end

7. Supplementary weft inlay on opposite sheds.

The design is drawn on graph paper. See Fig. 14. For each square of the graph paper there are three ground picks and six pattern picks. After each pick of plain weave, two picks of supplementary weft are laid-in in sheds that are opposites.

For the first inlay shed pick up warp ends 1,2,3 7,8,9 13,14,15 19,20,21, etc., and lay the decorative weft in this shed according to the design diagram.

For the second inlay shed pick up warp ends, 4,5,6 10,11,12 16,17,18, etc., and lay the decorative weft in this shed according to the design.

This technique can be done with two warp ends as well as with three. (Section 9 of the sampler).

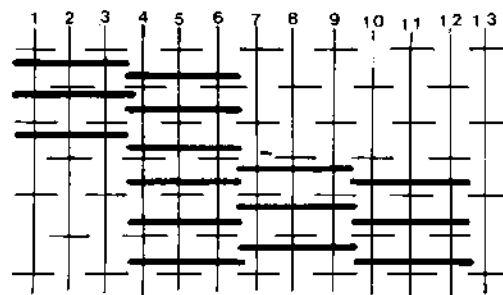

Figure 13.—Interlacement of fabric

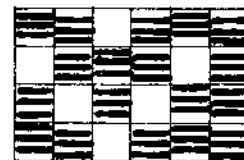

Figure 14.—Design—1 square for 3 warp ends



Front



Back

7.—Peruvian complementary weft tabby

8. Complementary weft inlay.

As opposed to the previous inlay techniques in which the decorative weft was supplementary to the ground cloth, the complementary weft inlay technique uses a decorative weft and a ground weft that are of equal quality and are both part of the ground structure of the fabric. Both wefts appear to interlace in plain weave on the surface of the cloth but make long skips on the under side of the cloth whenever the complementary yarn weaves on surface.

There are two types of complementary weft inlay. Both techniques are easier to weave when the wrong side (side of the floats) is up.

In Fig. 15, every other row (shed *a*) is a plain weave pick woven with the ground weft X. The alternate rows are woven by inserting a pick of weft X and a pick of weft O.

To weave X, shed *b* is opened and the background area is picked up.

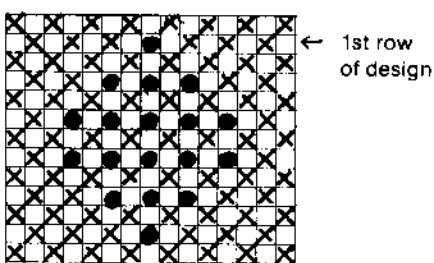

Figure 15.—One square for each warp end

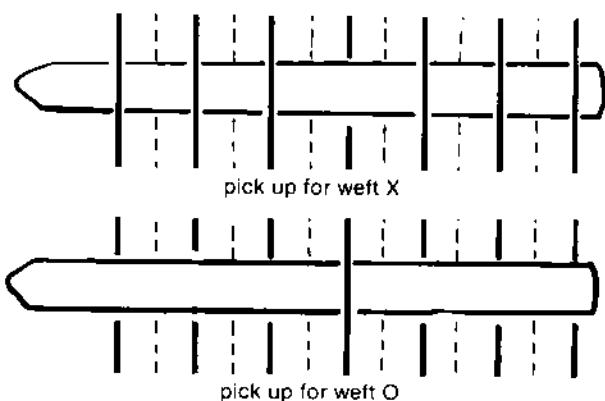

Figure 16.—Pick-up for the first row of the design in Figure 15

In Fig. 17, both shed *a* and shed *b* are woven with two complementary wefts. Therefore, follow the steps shown in Fig. 16 for both sheds *a* and *b*.

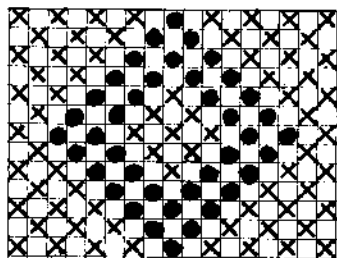

Figure 17.—One square for each warp end

General remarks

Not all inlay weaving is drafted on graph paper.

Free form shapes may be laid in, either in small areas or to cover entire ground cloth.

When different colored supplementary yarns are laid in next to each other in the same shed there is no need to interlock them as in tapestry because the fabric is kept together by the ground weft.

Supplementary yarns can be used very creatively because they can be made to appear on the surface of the cloth whenever the designer wishes them to. However, long skips underneath the fabric may cause problems and limit the use of the technique.

The wallhangings illustrated in Plates 2 and 4 are double cloth. The long skips of supplementary weft are hidden between the two layers of cloth.

Brocade is done with many of the same techniques as inlay. The techniques of "Dukagång", of loom embroidery and of complementary weft tabby are mostly used. Dukagång has its origin in Scandinavia while the weaves of ancient Peru have left remarkable examples of loom embroidery brocades and of complementary weft tabby. However, in the complementary weft fabrics of Peru the side of the fabric that has the floats is considered the right side.

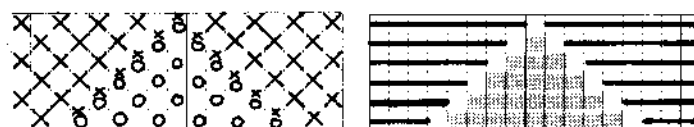

Figure 18A.—Back

Figure 18B.—Front

On the wrong side (illustrated in Fig. 18A) the two wefts that weave one row of the design cover the warp which outlines the pattern. This leaves that section of the warp exposed on the right (float) side of the fabric. (See Fig. 18B). The patterns for this technique must be developed along diagonal lines.

To weave the triangle of Figs. 18, repeat the following two steps:

1. Change the shed. Pick up the raised warp ends which outline the pattern (triangle) and all the raised warp ends of the background area. Weave the picked up shed with the color of the pattern.
2. Keep the same shed open. Pick up the raised warp ends which outline the pattern (triangle) (the same ones as in Step 1) and all the raised warp ends inside the pattern area. Weave the picked up shed with the color of the background.

Plate 7 illustrates both sides of a fabric woven in this technique.

Reference

Design in Weaving, Winifred Mooney & Nell Steedsman, 7 Georgia Ave., Leathington, Ontario

RUG BASED ON 3-SHAFT

The rug shown is done on a 4-shaft loom on a threading draft that is reminiscent of Crackle.

Fig. 1 is a Crackle threading draft showing the possibility of 4 blocks, each one being threaded on a 3-shaft point twill. There are linking ends between the blocks to insure smooth transitions of the pattern from one block to the other.

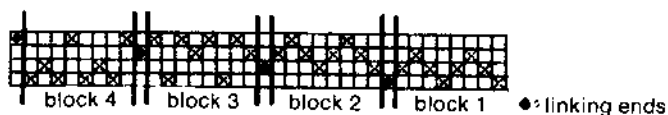

FIGURE 1

Fig. 2 is a draft showing 4 blocks, each one being threaded on a 3-shaft straight twill. There are also linking ends between the blocks. Peter Collingwood describes the theory of rug weaving on this draft on pp. 324-328 of the *The Techniques of Rug Weaving* (Watson-Guptill 1968).

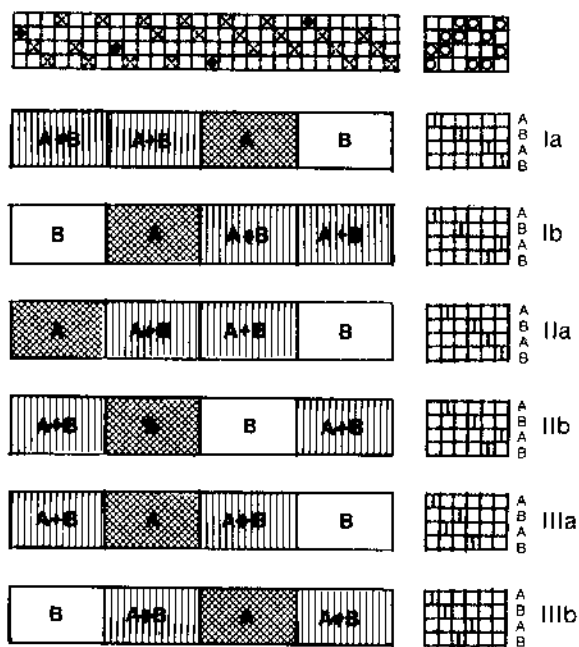

FIGURE 2

Fig. 2 shows 6 different treadling sequences, each woven with two shuttles (colors A and B) which are used alternately. The position of the solid A block, the solid B block and the vertically striped (A,B) blocks are schematically shown. In our example A is dark and B is light. The color scheme would be reversed if A were light and B dark.

When there is a reversal in the block arrangement such as in the rug shown here (see Fig. 6), there are two options: Fig. 3 is the draft used for our rug. Notice that there are no linking ends between the descending blocks. The rug woven with this draft is not entirely symmetrical and therefore the draft shown in Fig. 4 might be preferable.

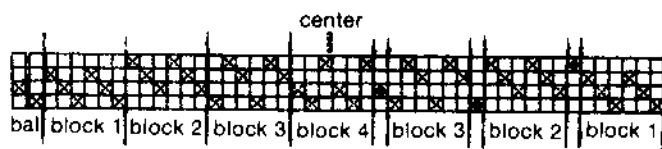

FIGURE 3. non symmetrical reverse block arrangement

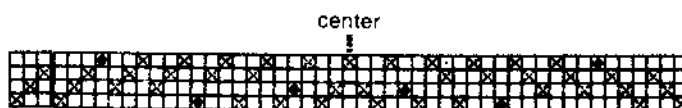

FIGURE 4. symmetrical reverse block arrangement

Weaving Instructions

WARP: 10/6 linen

WEFT: 6 ply rug wool

A shades of dark

B shades of light

SETT: 4 working ends per inch (16/10 cm). One has to cut 6 warp threads per inch (24/10 cm), but they are sleyed (single, double)-repeat.

SELVEDGES: Use floating selvedge and also reinforce the outer warp ends of the rug by using a triple thread. See Fig. 5.

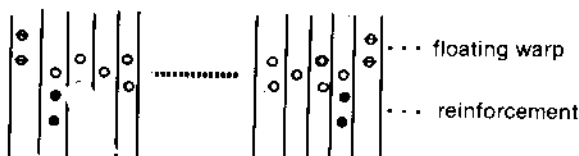

FIGURE 5

WIDTH IN THE REED: 32" (80 cm).

NUMBER OF UNITS IN THE DRAFT: 40 (See Fig. 6). There are 3 ends per unit but in addition, one has to make allowances for the linking threads between blocks.

STRAIGHT TWILL

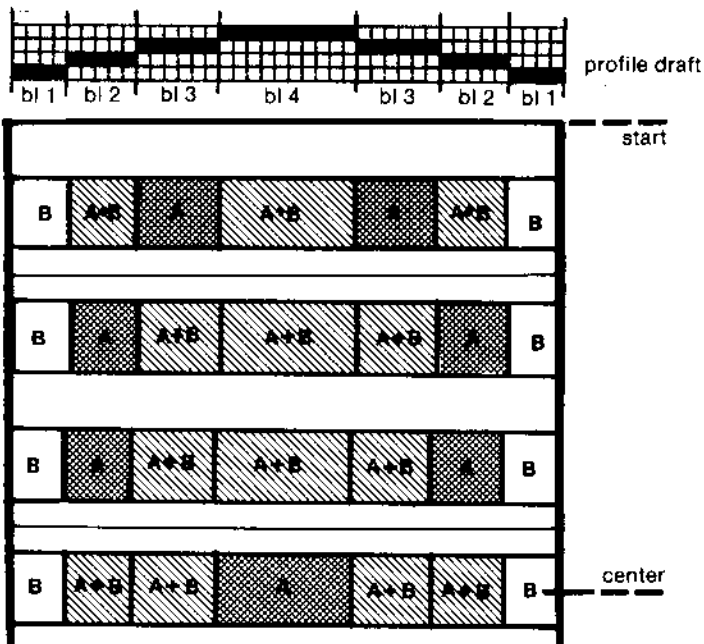
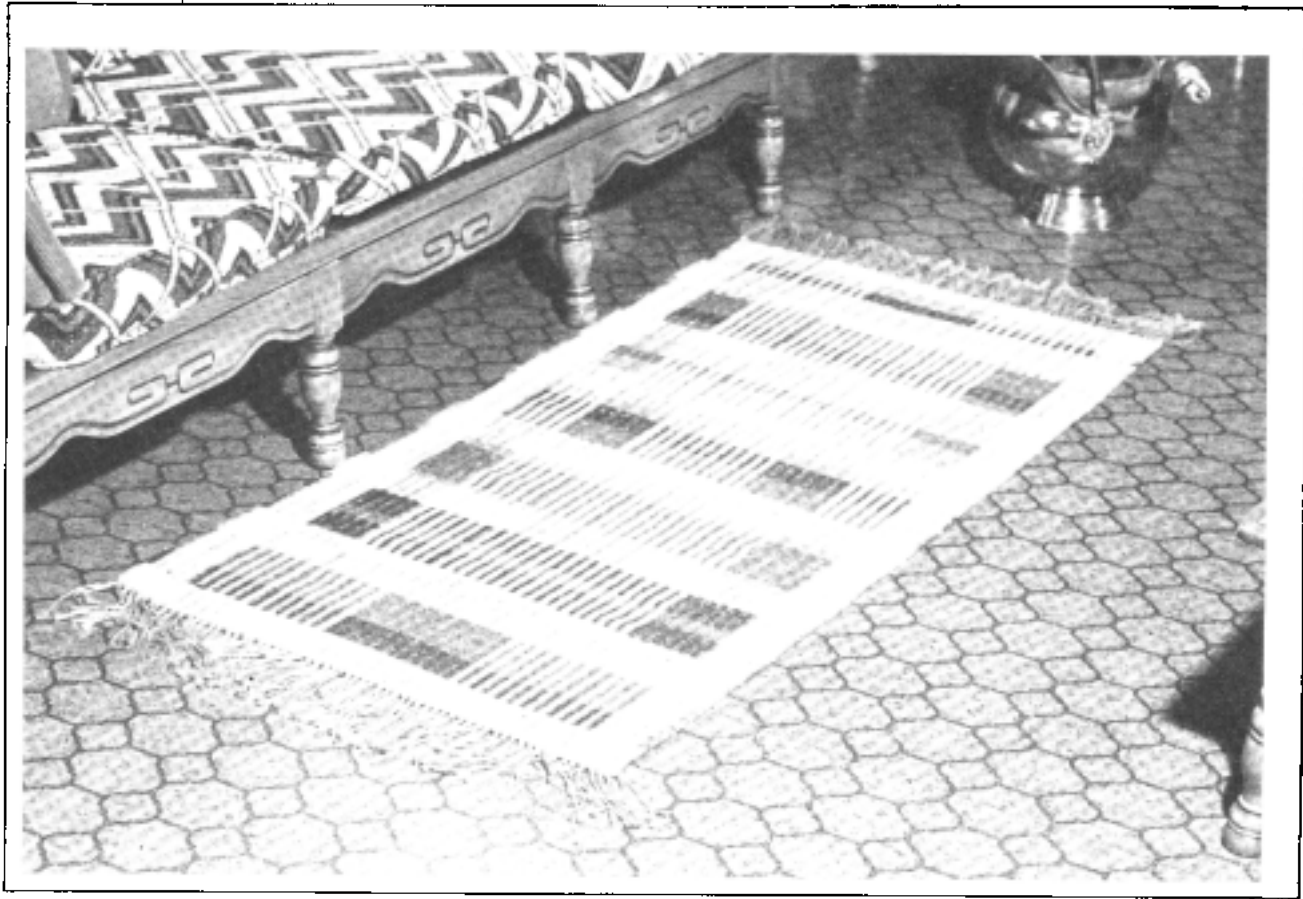
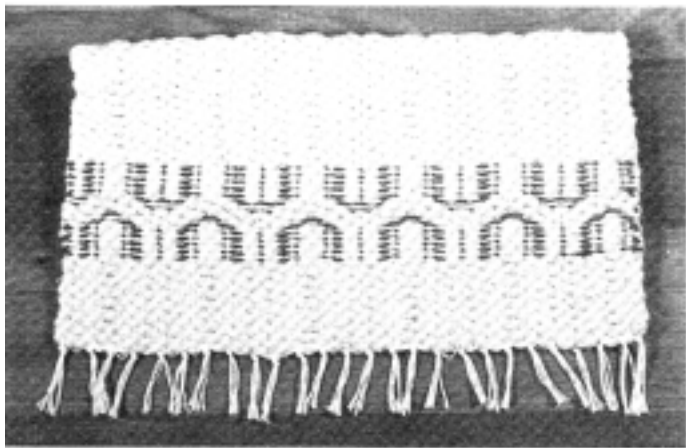

FIGURE 6

TREADLING:

- 3" treadling IIa with color sequence B,B,A,B.
 - 5½" treadling IIa with color sequence A,B,A,B.
 - 1½" treadling Ia with color sequence B,B,A,B.
 - 1½" treadling Ia with color sequence A,B,B,B.
 - 5½" treadling Ia with color sequence A,B,A,B.
 - 3" treadling Ia with color sequence B,B,A,B.
 - 5½" treadling Ia with color sequence A,B,A,B.
 - 1½" treadling IIIa with color sequence A,B,B,B.
 - 1½" treadling IIIa with color sequence B,B,A,B.
 - 2¼" treadling IIIa with color sequence A,B,A,B.
- This is the center of the rug; reverse the pattern.

The rug is finished with the Damascus edge, half-hitching single warp ends throughout. ■



RUG D

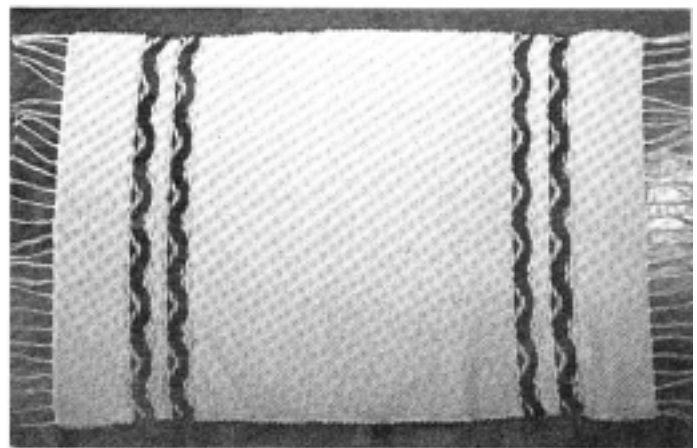

RUG E

THREADING

Eileen O'Connor

Notes:

- Start and end the rugs with 8 picks of tabby.
- Allow for a warp take-up of 15%, due to the thickness of the weft.
- Rugs will shrink considerably in width.

RUG A—Banded design. Each band is woven with one-color rags.

Treadle	1	2	3	4
Color	A	A	A	A

RUG B—Solid background with vertical stripes of color.

Treadle	1	2	3	4
Color	A	A	B	A

RUG C—Solid background with overshot picks in contrasting color.

Wool rag strips, 1/8" (12.7 mm) wide.

Treadle	1	2	3	4
Color	A	A	A	A, repeat for 4" (10.2 cm)
	A	B	A	B
	A	B	A	A
	A	A	A	A, repeat for 4"
	(D	D	D	D) 2 times
	C	D	C	D
	C	D	D	D
	(D	D	D	D) 2 times

RUG D—Solid background with overshot picks in contrasting color.

Mop cotton and cotton chenille.

RUG E—Solid tabby ground with borders done with Navajo Saddle pattern stripes.

Treadle	1	2	3	4
Color	A	B	C	A
	B	C	A	B
	C	A	B	C

RUG F—Flamepoint technique with cotton rags in four related shades.

Treadle	1	2	3	4
Color	(A	B	C	D) 4 times
	(B	C	D	A) 4 times
	(C	D	A	B) 4 times
	(D	A	B	C) 4 times

RUG F

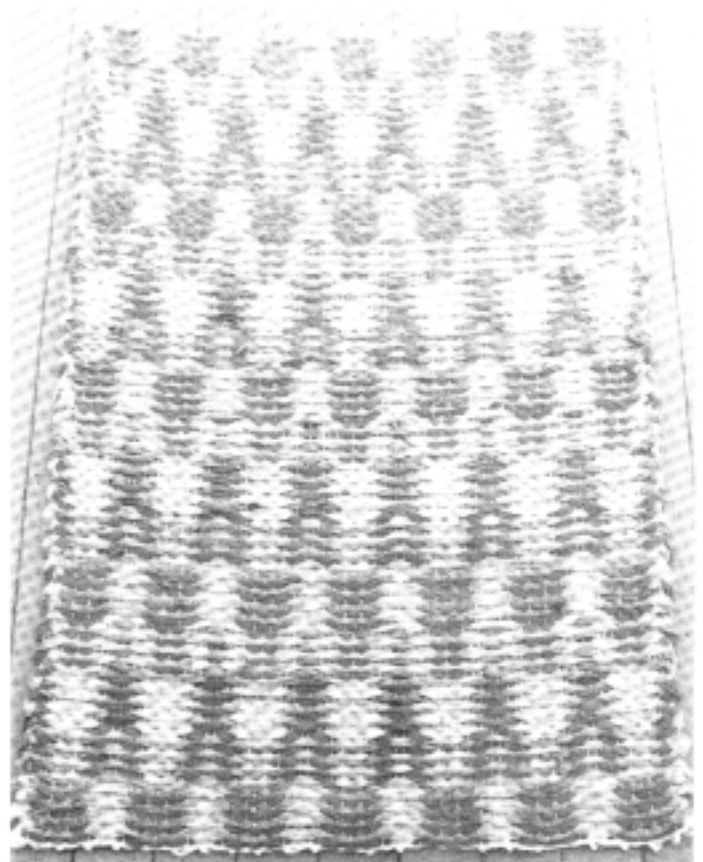

SHAFT-SWITCHING

ON 3-END DRAFTS

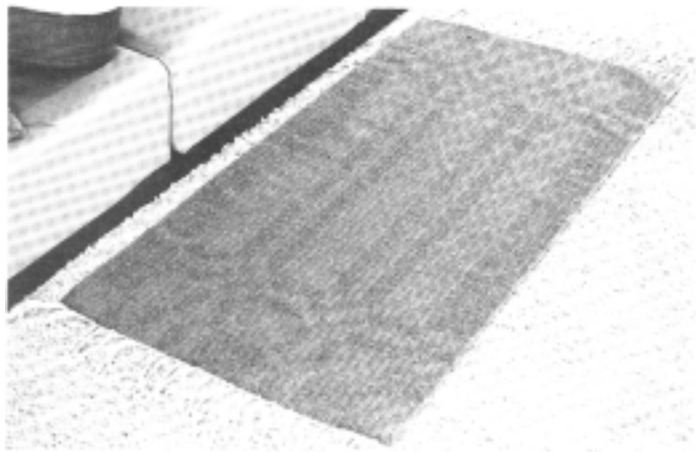

Rug woven on a 3-end block, two-tie draft without shaft-switching

The most popular threading draft for shaft-switching is the 3-end block, two-tie draft. Rug techniques woven on this draft are explained in *The Techniques of Rug Weaving* by Peter Collingwood, Watson-Guptill 1968, pp. 308-316.

The principle of shaft-switching opens a tremendous field of creative possibilities for the 4-shaft-loom weaver and the technique lies within the reach of everyone.

THE 3-END BLOCK, TWO-TIE DRAFT WITHOUT SHAFT SWITCHING

Fig. 1 shows the thread-by-thread draft and the block draft for a two block, 4-shaft pattern. Each unit has 3 ends and the units may be repeated ad lib. The weft floats are tied down by the warp ends on shaft 1 or shaft 2 and therefore these shafts are called tie-down shafts. Shafts 3 and 4 determine whether the unit belongs to block 1 or block 2 and therefore are called pattern shafts.

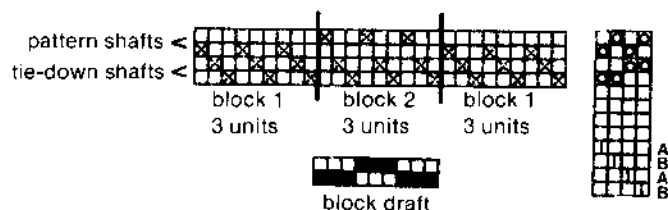

FIGURE 1

The rug shown here is woven on 43 units as shown in Fig. 2. The 43rd unit is split between the right and left selvedge as shown in Fig. 3.

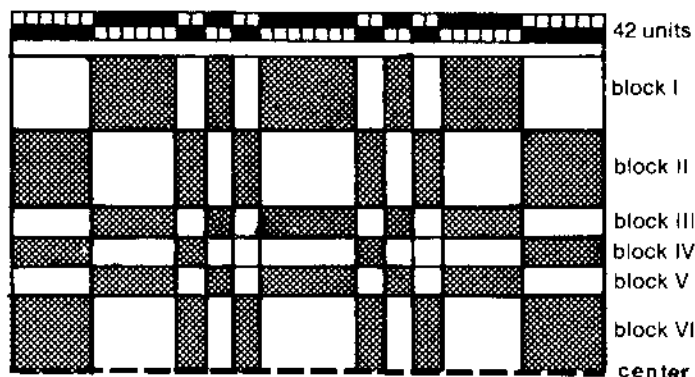

FIGURE 2

The selvedge threading of Fig. 3 eliminates the need for a floating selvedge if a 1/1 color pick sequence (A-B repeat) is maintained throughout and if the shuttles are initially started from opposite sides.



FIGURE 3

WEAVING INSTRUCTIONS

WARP: 10-6 linen

WEFT: Heavy single rug wool

A dark

B light

SETT: 4 working ends per inch (16/10 cm). There are six warp threads per inch (24/10 cm) but they are sleyed (single, double)-repeat.

SELVEDGES: Reinforce the selvedge by adding extra warp threads. See Fig. 4.

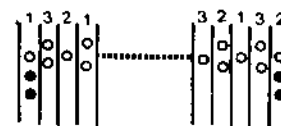

FIGURE 4

WIDTH IN THE REED: 32" (80 cm).

TREADLING: See Fig. 1

1st block, color sequence A,B,A,B. Repeat this sequence till the first block is square.

2nd block, color sequence B,A,B,A. Repeat this sequence till the 2nd block is square.

3rd block same as first, etc.

Note: If you plan to weave a shaft-switch rug on the same warp, use draft 5. The difference is that the shafts are counted back to front. Also leave empty heddles on shafts 3 and 4 as indicated on the diagram.

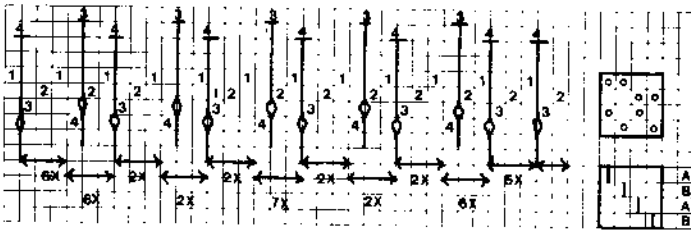

FIGURE 5

SHAFT-SWITCHING: WHAT HAPPENS TO THE DESIGN OF THE RUG?

The principle of shaft-switching and the use of #12 or #14 brass barrel swivels with safety snaps* for the mechanics of it was discussed in the Summer '80 issue of *The Weaver's Journal* pp. 5-9. Here the theory will be applied specifically to 3-end block drafts.

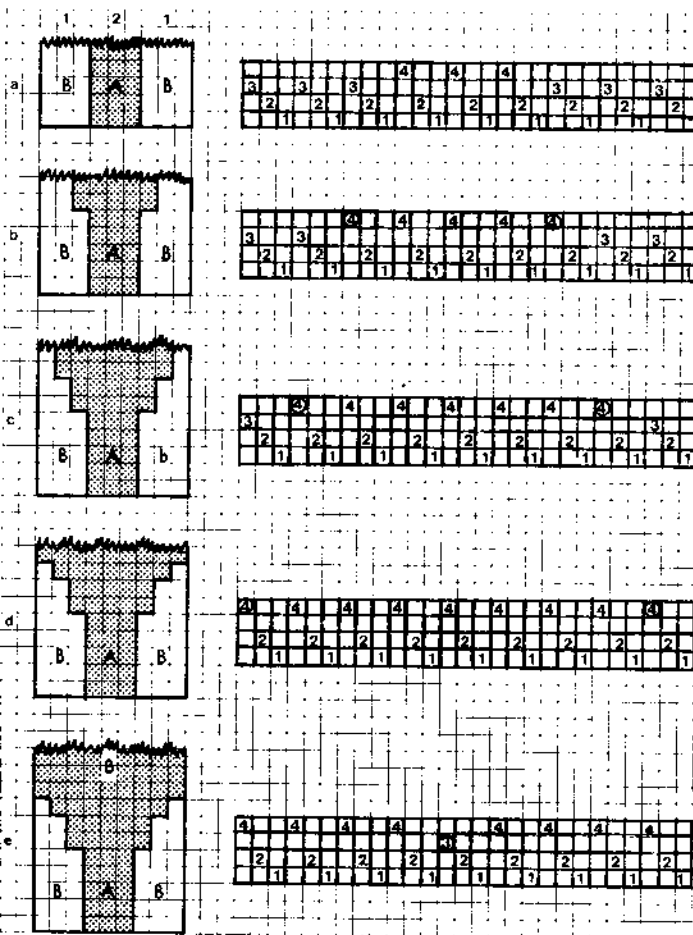

FIGURE 6

Fig. 6 shows the draft for the two 4-shaft blocks. The treadling sequence will weave a reversible rug as shown in Fig. 6a. If the pattern warp of the block is threaded on shaft 4, the block will be woven in color A. If the pattern warp of the block is threaded on shaft 3, the block will be woven in color B. Fig. 6b, c, and d show what happens to the design of the rug when pattern warp ends have been switched from shaft 3 to shaft 4. The A block grows wider and wider. Fig. 6e shows what happens when a warp end on shaft 4 has been switched to shaft 3.

SHAFT-SWITCHING MECHANISM: HOW TO DO IT

In order to make it possible to shift warp ends from shaft 3 to 4 and vice versa, these pattern warp ends are left floating during the threading but an empty heddle of shaft 3 and of shaft 4 is put on either side of the floating end. Then, a safety snap is threaded onto each pattern warp end (see Fig. 7) before it is tied to the apron rod. With this snap, the pattern end can be pinned either to the eye of heddle 3 or to 4. On the threading draft this is indicated with the 3/4 symbol as shown in Fig. 8.

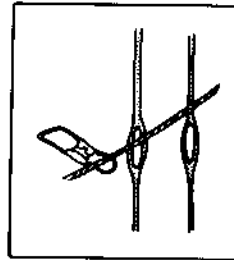

FIGURE 7



FIGURE 8

Note that the pinning and unpinning of warp threads is facilitated if the pattern shafts are close to the weaver, that is, if the shafts are counted from back to front. The draft of Fig. 9 makes this clear and is the most practical draft for shaft-switching.

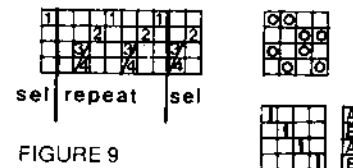
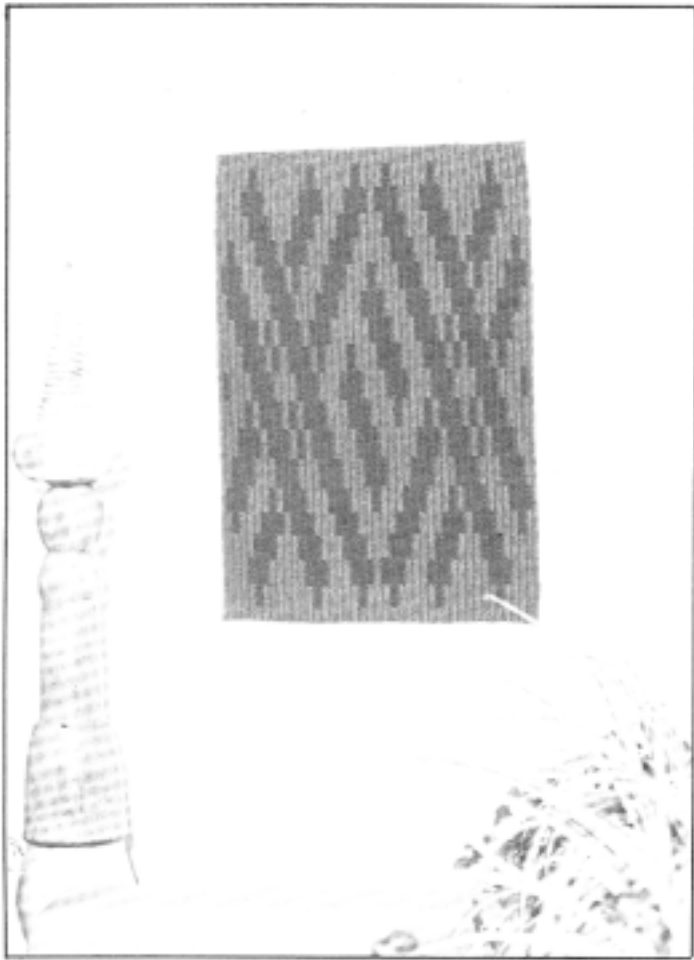

FIGURE 9

Remember to start shuttle A and B from opposite sides.

*Available at fishing and sporting goods stores.



Rug woven on a 3-end block, two-tie draft with shaft-switching. Design shown in Fig. 10.

DESIGN

Inspiration for designs come from everywhere.

Prepare a piece of graph paper with as many units as needed for the width of your rug.

For a 32" (80 cm) loom with a warp sett at 4 epi (16/10 cm), there are 128 warp ends. This is just about 43 units ($43 \times 3 = 129$) which includes the split selvedge unit (see Fig. 3).

The designs of Figs. 10 and 11 are inspired by fancy twill patterns and are used for the rugs which illustrate this article. Both are designed on 43 units. The simplest designs are based on vertical bars as in Fig. 12. The designs of Figs. 13 and 14 are based on lattice work. Fig. 15 shows a triangular design that can be worked into lozenges. Fig. 16 shows a fret design. Fig. 17 shows a stylized flower design based on a free-hand drawing.

The more solid vertical elements there are in the design, the less shaft switching needs to be done during the weaving process.

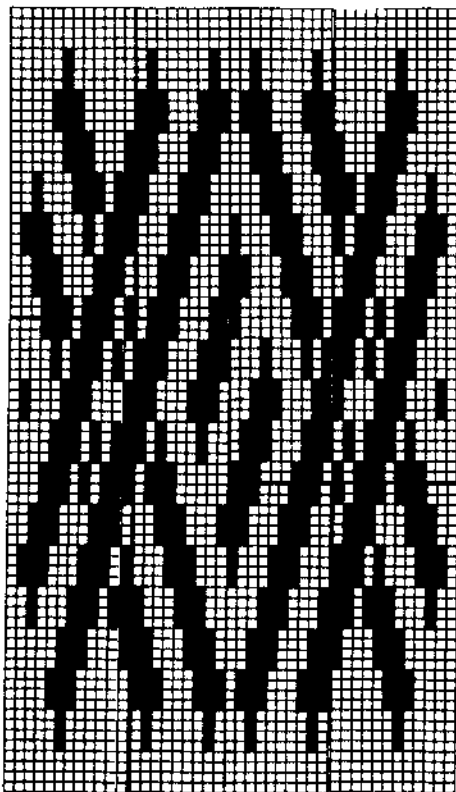

FIGURE 10

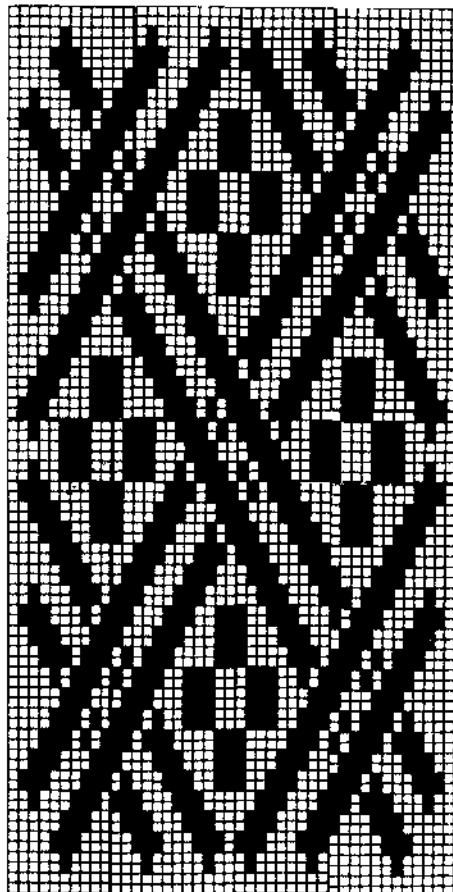

FIGURE 11

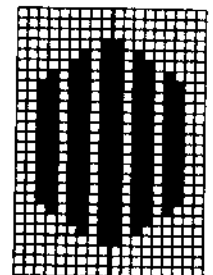

FIGURE 12

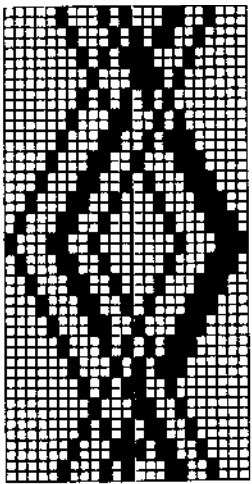

FIGURE 13

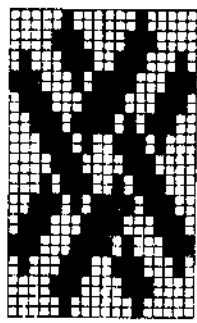

FIGURE 14

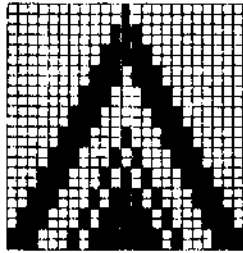

FIGURE 15

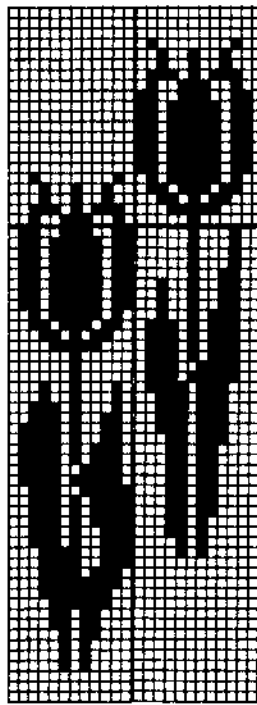

FIGURE 17

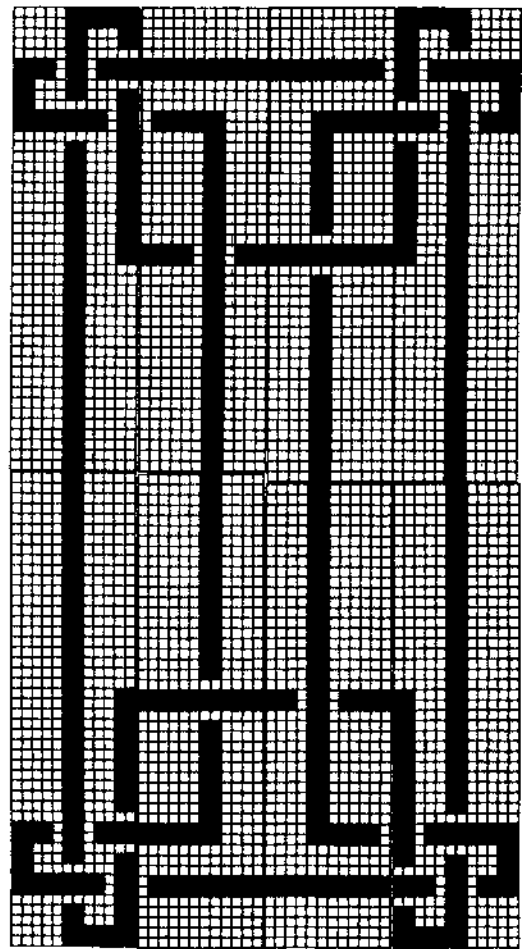

FIGURE 16



Rug woven on a 3-end block, two-tie draft with shaft-switching. Design shown in Fig. 11.

The specifics for the shaft-switch rugs are the same as for the 3-end block, two-tie rug described earlier in this article. The threading is shown in Fig. 9 with 42 units plus the selvedge unit. There are 129 working ends (65 single, 64 double). Thus, one has to cut 193 threads plus 4 to reinforce the selvages.

If A is the dark shade and B the light shade, the rugs of Figs. 10 and 11 are started by pinning all the pattern warp ends to the heddles of shaft 3 in order to weave the light border. When the pattern starts, count the units that have to weave dark. Unpin the pattern threads of these units from 3 and pin them on 4. Do not shaft-switch in the middle of a treadling sequence.

Shaft-switching on 3-end block drafts is faster than on the 4-end drafts (Summer and Winter) because here only one out of 3 threads are pattern ends while in the 4-end draft every other thread is a pattern end. However, the pattern blocks are less solid with the 3-end draft than with the 4-end draft.



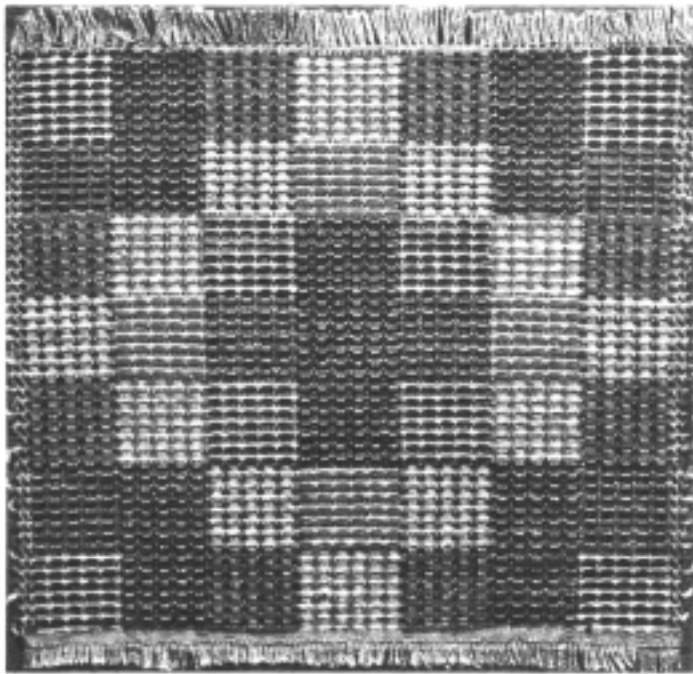

Sample 1

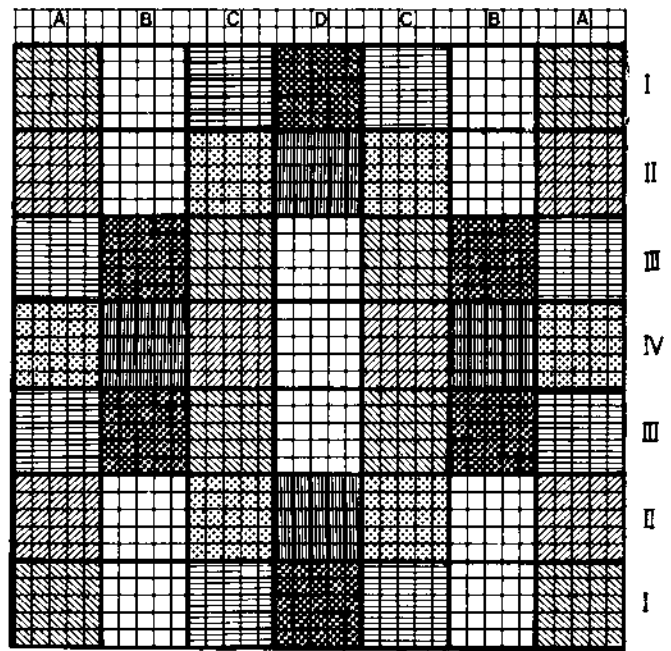

MODERN OVERSHOT (Frappé Moderne)

by Agathe G. Collard

In the early nineteen sixties I had the good fortune to stay at the late S. Zielinski's home taking some weaving courses. The study material was immense and the ideas often new ones. However, some of this information is now all but forgotten.

Today, the new weavers are once again wanting to learn new techniques. This has revived my own interest in what I had learned, especially about the technique of modern overshot.

My intention here is not to draw a comparison between modern and colonial overshot. This was done by S. Zielinski himself and published in the Nov. 1954 issue of *The Master Weaver* (#18). I merely want to share my own experiences with the technique and in so doing open new ways for creative interpretations. I did the work on four shafts but am not ignoring the possibilities and the challenges of multi-shaft looms.

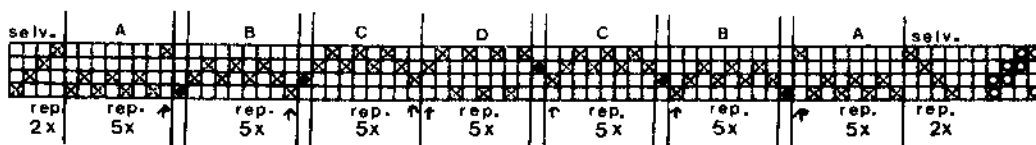

FIGURE 1. Pointed block arrangement—7 thread floats

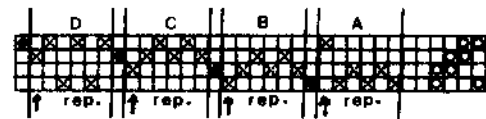

FIGURE 2. Straight block arrangement—5 thread floats

The threadings are given here for a straight and for a pointed arrangement of the blocks.

Note that after the turning point, the linking thread precedes the block and the tie-down thread is the first thread of the unit instead of the last.

The floats may be 5, 7, 9 or more threads long, depending on the closeness of the sett of the warp and of the function of the fabric. The units may be repeated ad lib.

The units may be repeated ad lib.

☒ = linking thread between blocks
↑ = tie-down thread for each unit

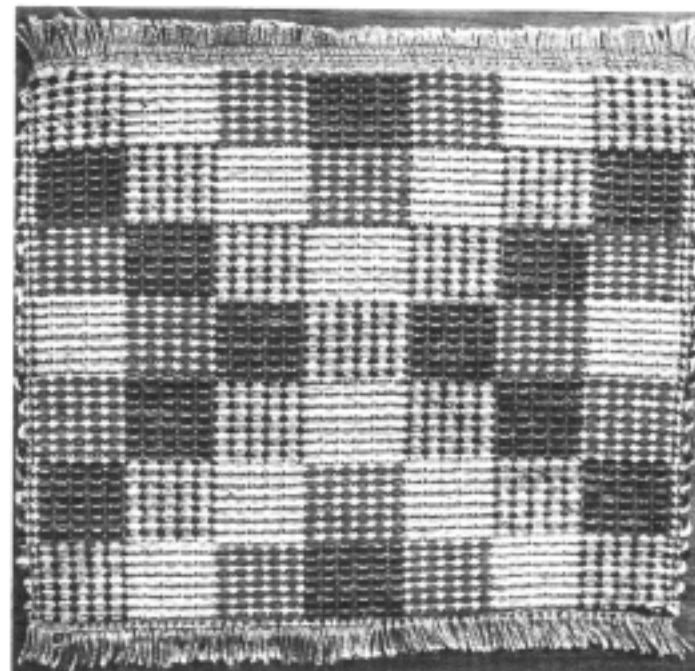
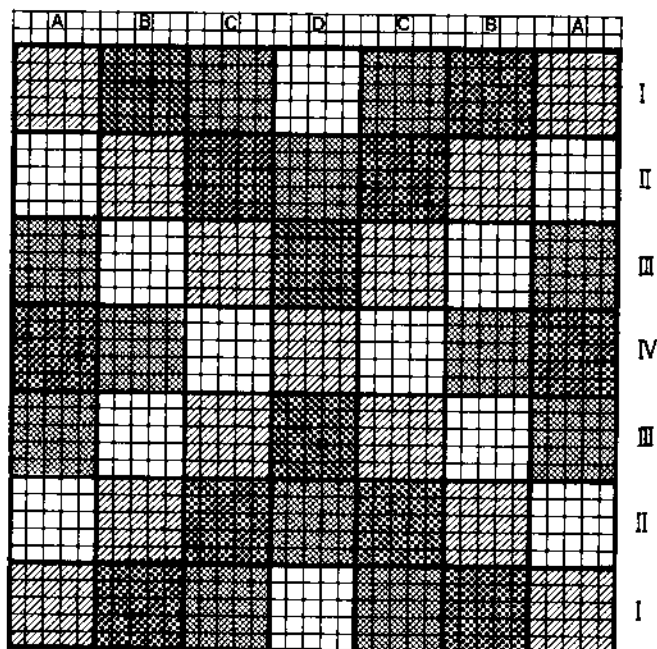

Sample 2

The choice of yarns is unlimited. One can either work in monochrome with textured wefts or in a wide color range with yarns that are similar or not.

Modern overshot can be woven with or without tabby binders (samples 1, 2 and 3 are without, sample 4 is with). If no tabby binder is used it is not necessary for the warp to be covered as in boundweave; nevertheless, the importance of the warp is diminished because of the strong pattern effects created by the weft.

When the warp is close sett and the floats are short, the technique of modern overshot is great for upholstery fabrics. Other suitable uses are napkins, table runners, wallhangings, bags, bedspreads, draperies, pillows, etc.

There are advantages for a weaver to use this technique because a single warp offers many design possibilities through color, fiber and reading.

The samples shown here are woven on a gray acrylic warp sett at 24 epi (100/10 cm) in a 12 dent (50/10 cm) reed. The threading is shown in Fig. 1. The weft colors are Red, Gray, Black, White, Pink.

Weft sequence for sample 1:

	tr 1	tr 2	tr 3	tr 4	
block I	(R G B B)				repeat to square the block
block II	(G R B B)				repeat to square the block
block III	(B B R G)				repeat to square the block
block IV	(B B G R)				repeat to square the block

Weft sequence for sample 2:

	tr 1	tr 2	tr 3	tr 4	
block I	(G W R B)				repeat to square the block
block II	(B G W R)				repeat to square the block
block III	(R B G W)				repeat to square the block
block IV	(W R B G)				repeat to square the block

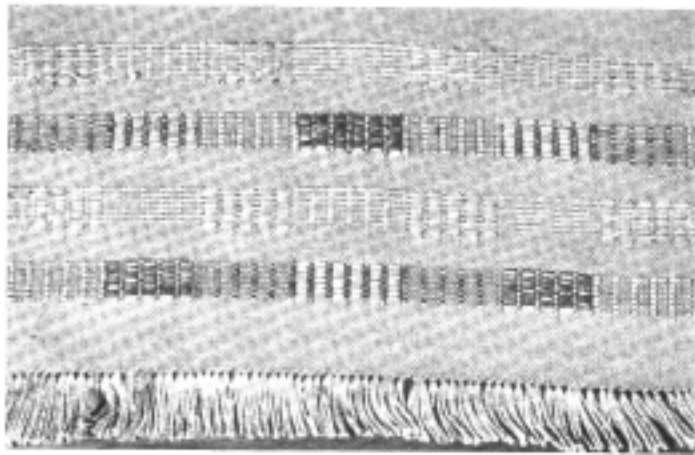

Sample 3

Weft sequence for sample 3:

- 1" tabby (R)
- 1" pattern: (tr 1 (R), tr 3 (B)) repeat to square the block
- 1" tabby (R)
- 1" pattern: (tr 2 (P), tr 4 (R)) repeat to square the block
- 1" tabby (R)
- 1" pattern: (tr 1 (B), tr 3 (R)) repeat to square the block
- 1" tabby (R)
- 1" pattern: (tr 2 (R), tr 4 (P)) repeat to square the block



Sample 4

Left sequence for sample 4:

Same sequence as for sample 1 but with a tabby binder after each pattern pick.

Translated from French by Clotilde Barrett

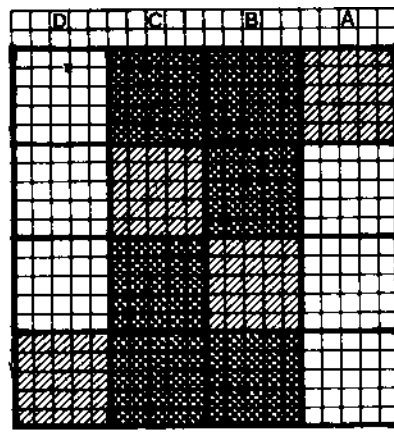

1 2 3 4 treadles
B W G B color
G W W B
B W W G
B G W B

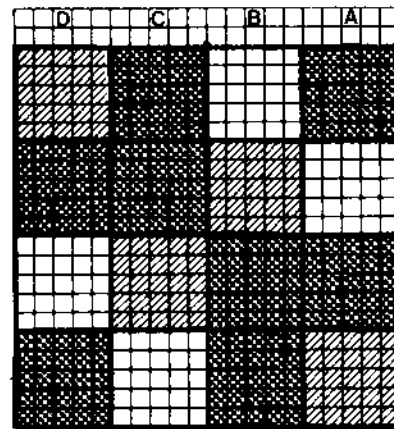

1 2 3 4 treadles
B G B W color
B B G W
G W B B
W B B G

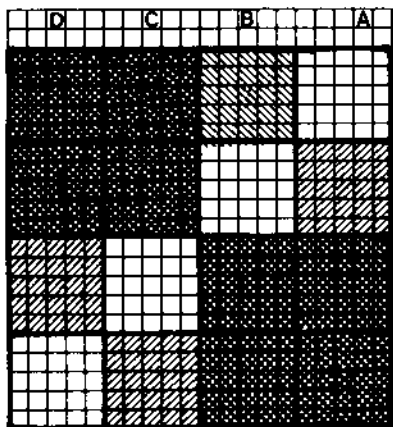

1 2 3 4 treadles
B B W G color
B B G W
W G B B
G W B B

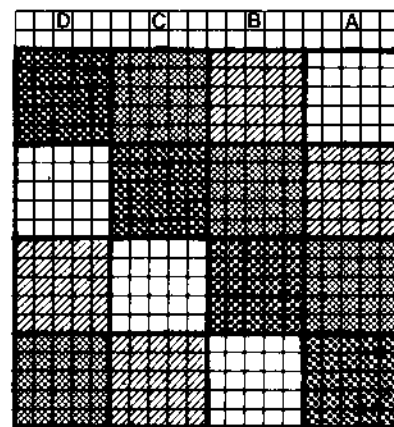

1 2 3 4 treadles
R B W G color
B W G R
W G R B
G R B W

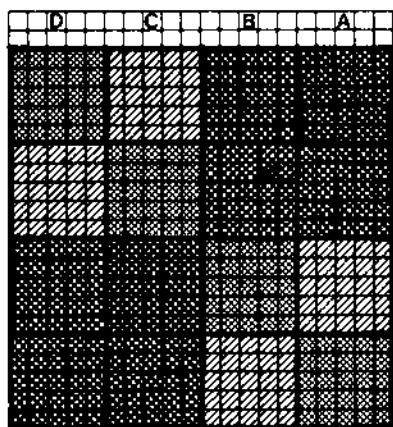

1 2 3 4 treadles
G R B B color
R G B B
B B G R
B B R G

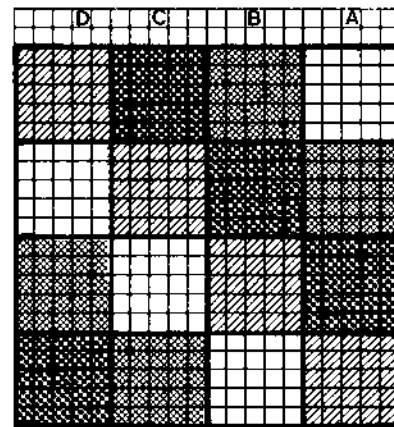

1 2 3 4 treadles
B G W R color
G W R B
W R B G
R B G W

R = Red
B = Black
G = Grey
W = White

Suggestions for color effects on a straight block arrangement

WEFT IKAT FOR RUGS

by
Lydia Van Gelder

photos by
H. W. Van Gelder

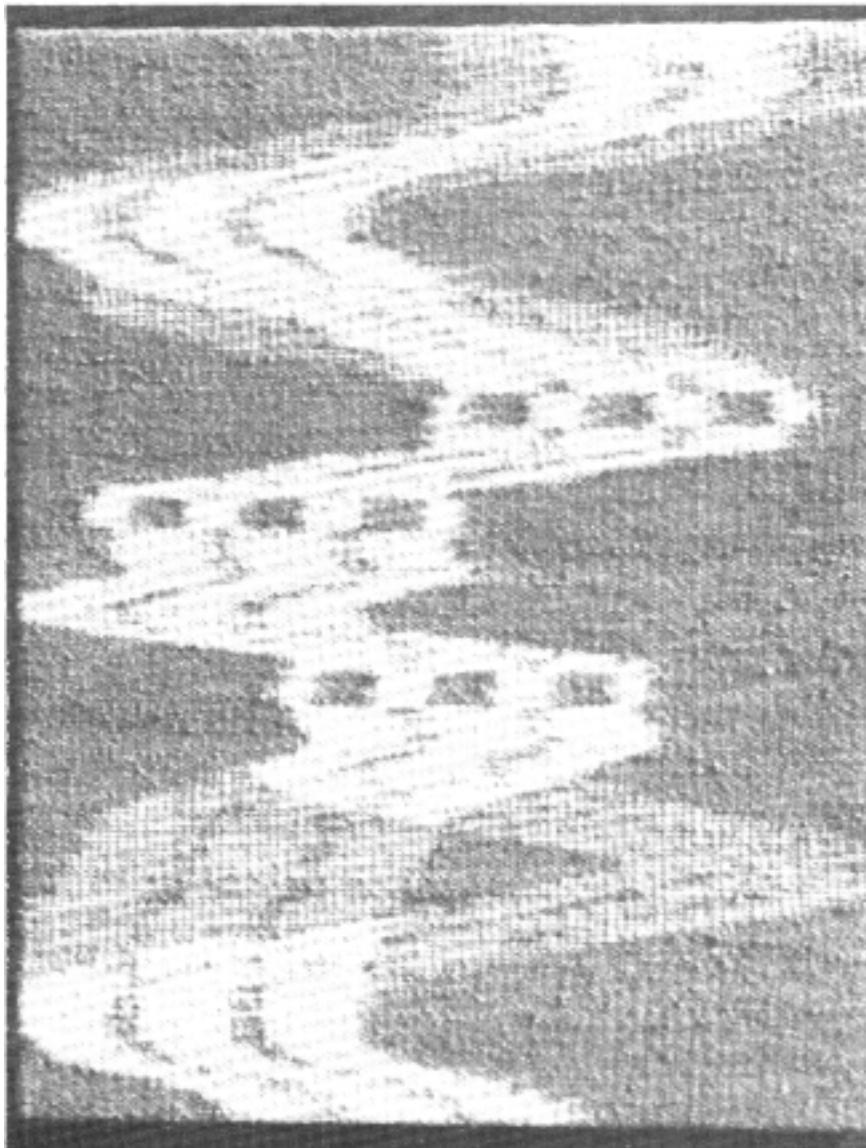

4. *Shifting weft, handspun, indigo dyed. Two skeins tied to compliment each other.*

Ikat, as we have come to know the technique, is the process of wrapping or binding off sections of yarn to resist the dye during dyeing, before the textile is woven. This wrapping or binding off may be done on yarn to be used for the warp, the weft or both. The unwrapped areas of the yarn absorb the dye while the wrapped sections remain undyed.

There are four types of ikat depending on which group or groups of yarn carry the resist patterning.

1. A warp ikat is a fabric where only the warp yarns are tied to resist the dye and form the pattern.
2. A weft ikat implies that only the yarns used in the fabric weft are resist tied to form the pattern.
3. A double ikat is a fabric for which the yarns of both the warp and weft are tied off so as to coincide with each other in a pre-determined pattern.
4. In compound ikat both warp and weft yarns are tied off

but they form independent resist patterns in harmony with each other.

Double ikat and compound ikat are usually, but not always, a balanced plain weave. Warp and weft ikat are most successful if the yarn system carrying the pattern dominates. This can be in one of the following ways:

1. Having the patterned yarns a little heavier than the opposing system.
2. More p.p.i. or e.p.i. according to whichever yarn system is featured.
3. The fabric is woven in a rep weave. This may be warp rep or weft rep. The yarn system which has no pattern is completely covered.

For now we will concern ourselves with weft ikat woven in a weft faced weave and a density suitable for a rug.

*Photos Nos. 1, 2, 3, 4, 5, 6 and 8 © 1980 by Watson-Guptill Publications.
Reprinted by permission of Watson-Guptill Publications.*

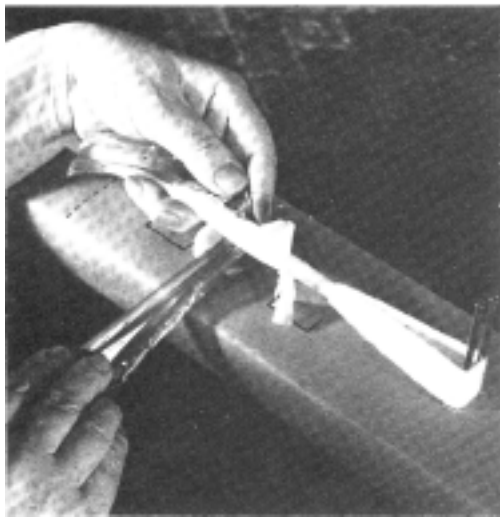

1. Starting the resist wrapping on a 2" x 4" length of lumber with marks on the paper for the areas of the resist ties.

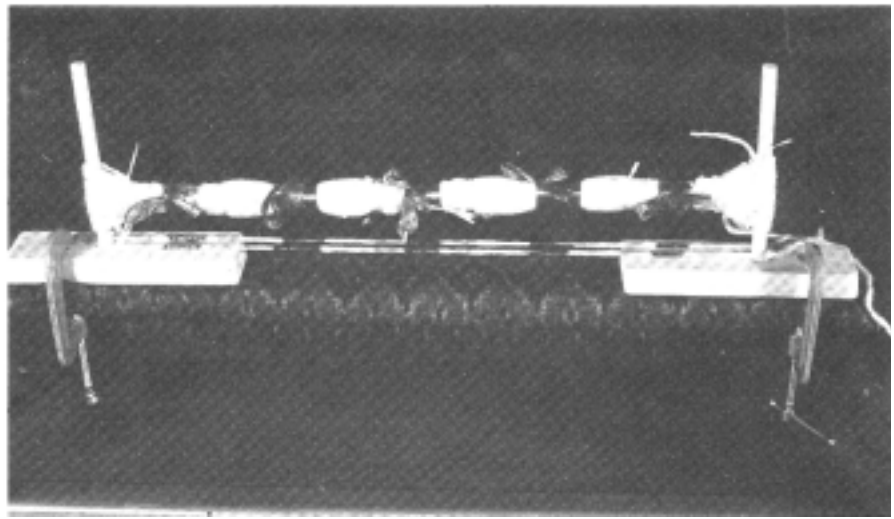

2. Adjustable weft winding and tying devices. Easily constructed, this is the best weft skein device for accurate measurement.

For this project you will need

1. A sturdy four shaft floor loom and weaving accessories.
2. A reed to accommodate either 4, 5 or 6 e.p.i. (16, 20 or 24/10 cm).
3. Cotton or linen warp yarn.
4. White or a light colored rug wool for weft; medium to large size and either handspun or commercial.
5. Plastic tape for the resist ties.
6. A weft winding and tying device.
7. Dye for wool fiber such as natural dyes, indigo vat, Ciba Kition, Cibalon or any dyes of your choice suitable for wool.

It is advisable that you first experiment with several weft faced weave structures and then select the weave and the ikat pattern for your rug. A note here: A $\frac{1}{3}$ twill woven "on opposites" will give a reversible weave and makes a good fabric weight for rugs. Your two alternating shuttles could carry an ikat weft and a plain weft, respectively.

The heavier your weft yarn, the more widely spaced the warp should be, such as 4 e.p.i. For a medium weight rug wool sett the warp at 6 e.p.i. Use a firm beat, pack the weft well and cover the warp.

To make 6 rug samples of 12" X 12" finished size (plus 4" fringe) and sett at 6 e.p.i., wind 80 ends, 4 yards (3.65 m) long (plus loom waste) of your warp yarn. Thread (1, 2, 3, 4) repeat, for 13" (33 cm) and double the outer warp threads for each selvage. When each sample is cut from the loom, finish the fringe. Weigh the sample to enable you to estimate how much weft yarn is needed per square foot of your projected large rug.

Calculating the weft length for weft ikat

During the dyeing you will have a varying amount of yarn shrinkage, which is certainly a consideration for a weft ikat rug! Shrinkage will vary with the kind of yarn: commercial or handspun. Even in handspun yarn, shrinkage will change with the type of wool used. It is therefore advisable to proceed with pre-shrunk wool yarn.

A quick method to calculate your weft is: width of fabric + shrinkage caused by dyeing + take-up weaving + extra allowance for the shifting weft which is a characteristic of this technique.

A more precise way is called the "X" measurement. With the warp on the loom dressed to the desired width, sett and correct threading draft, weave at least 3 inches (75 mm) or until you have established the beat and true weaving width. Count the number of p.p.i.; record this. With a felt-tip pen mark the weft yarn as it turns at the selvage for 5 or 8 picks, to indicate the length of each weft shot. Unweave this weft yarn and measure it as follows: Stick a heavy duty pin in a Celotex board or any similar firm board, tie the yarn to the pin with the first selvage mark exactly at the outer edge of the pin. Stretch the weft across the board under tension and insert another pin so that the second mark will be on the outer edge of this second pin. Now wind the weft yarn several times between the pins, making sure the marks line up exactly. Measure the distance between the pins. This is your X measurement (width plus take-up).

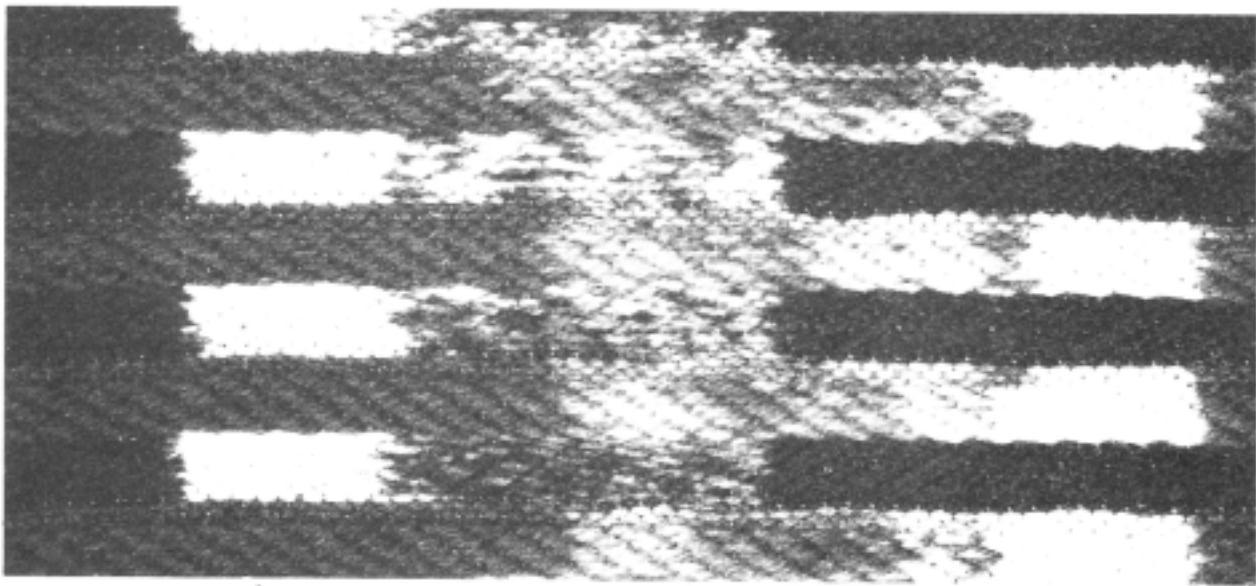

3. A weft ikat reverse $\frac{3}{1}$ twill in combination with tabby created a "washboard" effect in the weave when it was taken off the loom. Wool.

Yarn tying.

There are many factors which enter into the creation of an ikat rug: type of fiber used, binding or tying off of the resist areas, dyeing, weaving and finishing. However, it is the yarn tying of the weft skeins which sets ikat apart from other resist techniques. Essentially you must tie to resist the dye. When you wind the weft skein (under tension) for the tying of the resist areas, you should keep in mind that the closer together the resists are, the smaller the skein must be; the farther apart the resists are placed, the thicker the skein may be. This is to give sufficient space for the dye penetration.

Of all the materials that have been used for tying (rubber bands, string, raffia), the best by far, is the plastic tape made in Japan and sold through craft shops in the United States. I am using it in Photos 1 and 2. Wrap several times around the resist area, depending on the resist material, and tie in a knot. There is a Japanese knot I use most of the time (see *Ikat!* pages 56-58). However, until you master the Japanese knot, use a square knot to tie off the ends of each wrap. Make your wrapping very firm, almost as hard as you can; a soft spongy wrap will let some dye penetrate under the resist ties.

If you have established your weaving width and found the X measurement, this can weave a **pattern of blocks or stripes** with no undulation of pattern (as in Photo 3) and have nice even selvages.

Set up your weft winding and tying device.

We show here two types. The first (Photo 1), is just a 2" X 4" (5 X 10 cm) length of lumber wrapped with brown paper and two nails driven in at each end of the weft length. It works very well except that each time you

change the length of the weft skein, you have to change the position of the nails. On the paper, the center of the weaving is indicated by the dotted line and marks indicate where the resists are to be tied. The second (Photo 2), is by far the best winding and tying device because it can easily be adjusted to the slightest change in the length of the skein. A master thread with the resists marked lies just underneath the wound skein and serves as a guide for tying. For more about weft winding and tying devices, see *Ikat!*, chapter 3. Wind the yarn in a thin layer because bunching up the yarns will result in weft yarns of unequal length, will distort your pattern and make uneven selvages.

For a shifting weft or **undulating design** you have to allow extra yarn on each side beyond the selvedge line. How much you allow will depend on how much you wish to shift the pattern. Photos 4, 5 and 6 are examples of the shifting weft method.

Calculating the weft length for shifting weft ikat.

Decide how wide and how long your rug is to be. Sketch a design with flowing spaces on paper. This will serve as a guide to tell you how much the weft will shift from side to side. Next lay a long piece of string on the paper, mark the selvedge lines and where the resists will fall. Holding the string taut between your hands, move it back and forth following the general design. You will then see how much extra weft width is needed to adjust to the undulation of the pattern. Mark the string with the extra needed to accommodate the shifting weft. This will be the length of your weft skein. Go back in your notes and see what p.p.i. were recorded. You now know how many weft ends are in your design and how long to wind the weft skein.

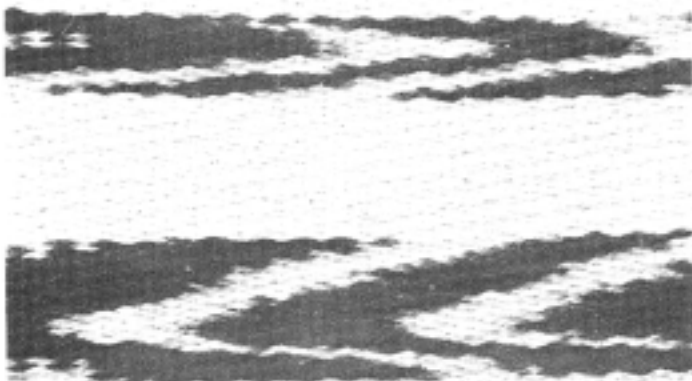

5. *Shifting weft. Dyed areas, rather than the resist parts, seem to carry the pattern because the background is white, same as the resist. Thicker or thinner lines develop as the weft is shifted slowly or rapidly.*

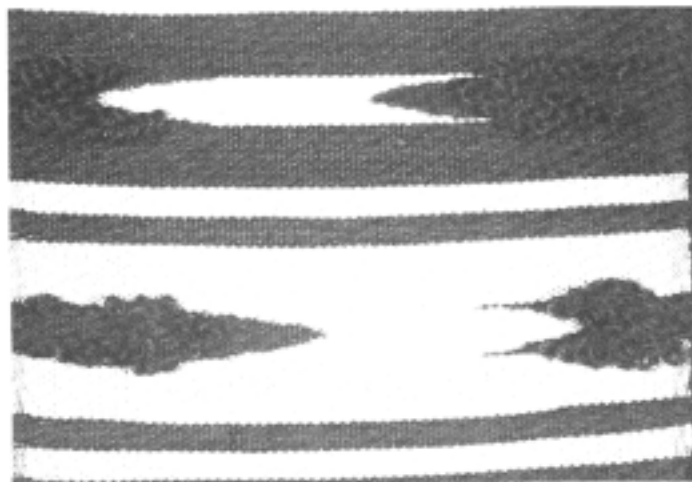

6. *Shifting weft. Loops develop a texture and take up the extra yarn from the shifting weft. Stripes between the ikat patterns alter the design.*



7. *Shifting weft. A looped texture takes up the extra yarn and forms a smooth selvedge.*

Selvedges.

When you weave a shifting weft ikat pattern in a rug, the selvedges may be treated in several ways and become a feature of the rug. Bind several yarns together with a wrapping, contrasting or not, and cut the surplus ends to form a fringe. In Photo 8, the ends are ready for the wrappings. These ends could also be braided to form a fringe, tied and cut to trim.

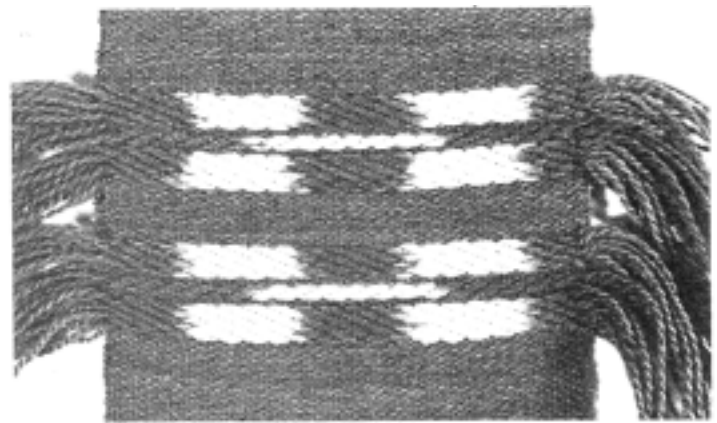

8. *Selvedge ends ready for wrapping, knotting or braiding to form an interesting selvedge detail to the rug.*

There is another technique I have used to take up the extra yarn and at the same time give a smooth selvedge to the rug. This is to draw up the extra yarn in loops over a gauge similar to a dowel or a sword while keeping the selvedge tight. If you make loops on alternative sheds, the weaving packs well. Photos 6 and 7 show how this added texture can enhance the design.

To form a large room-size rug, weave strips of shifting weft ikat and take advantage of the extra weft yarn. Join the strips together, pulling the extra yarn to one side (or both sides) and cutting to a row of shaggy, intermittent tufts.

You might like to use the Guatemalan selvedge treatment. It consists of weaving the extra weft back in. This causes a slight lumpiness but gives a neat edge. (See *Ikat!*, page 96 and Fig. 93).

In Photo 4 the selvedge was no problem because this was a mounted piece and the ends were folded behind the mounting. The pattern covers the full length of this piece and was done with two patterned skeins tied to coincide within the design.

....

We see in Photos 5 and 6 how the plain, non-ikatted yarn, woven between the patterned yarns, changes the look of the design. In Photo 5, it appears that the dyed sections of the ikat yarn come out as pattern, whereas in Photo 6 the change of plain yarn from dark to light, completely alters the look of the patterned ikat sections.

After you have mastered some of the ikat techniques, try the e-gasuri method. (Japanese picture ikat). In *Ikat!*, (Project 6), this technique is explained. It can be applied to a rug with fantastic possibilities if the design is kept simple.

Enjoy! Enjoy! Ikat is a joy to weave and a joy to behold!

References

1. Van Gelder, Lydia. *Ikat*, © 1980 Watson Guptill, N.Y. NY. (includes an extensive bibliography on ikat).
2. Robertson, Vanessa. *Ikat*, *The Weavers Journal*, Quarterly Journal of the Assn., of the Guilds of Weavers, Spinners and Dyers; London, Autumn 1978, #107



"Along the Yangtze" © 1978



"Spring" © 1978

STATEMENT OF MY IDEAS

by Kate O'Callaghan

photos by Kate O'Callaghan



*Ed: Kate O'Callaghan is a tapestry weaver from Arizona and has contributed the series of articles on tapestry techniques published in *The Weaver's Journal* issues Nos. 15, 16, 17 and 18.*

Since 1978, I have been working out a mythology evolving from a central theme: the earth is, as Plato said in the *Timaeus*, a great being. When you try to imagine this being, be sure to realize that if we have wit, intelligence, dreams and imagination, so too does the great being which has imagined us and on whose surface we flash for a brief moment.

The first series of tapestries deals with river canyonland topographies. **Heartland** describes the rich, red flow of life in the earth naked

of flora. **Along the Yangtze** illuminates the delicate variations in temperature of land and rivers, and in so doing takes on a Chinese feeling (I think of Pearl Buck and *The Good Earth*). **Breaking through the Skin** is an allegory of the intermingling of sky-water and earth to create the smaller lives of earth creatures. **White Way** is concerned with the formation of flow channels in this biological topography. **Spring** illustrates the narrow green channel of life water flowing through the stony drylands of an older, slower life form.



"Earth Memory", cartoon © 1979



"Earth Memory", detail © 1979

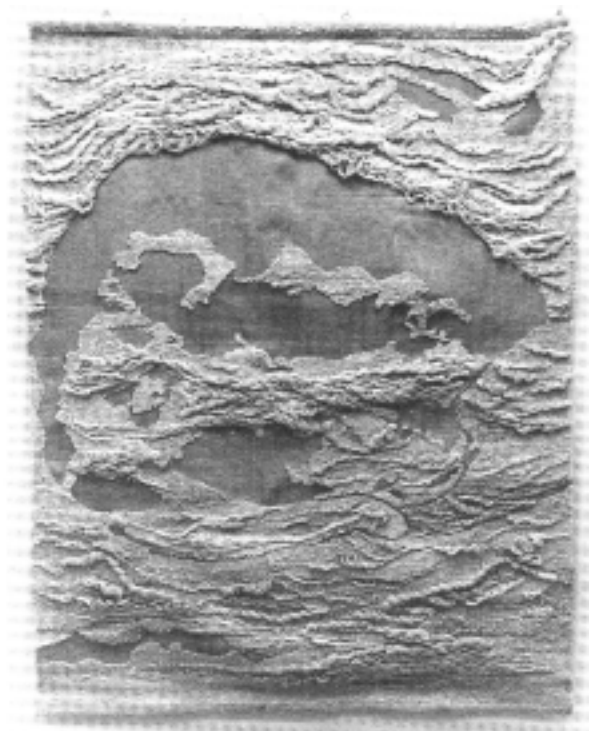

"New World" ©1979

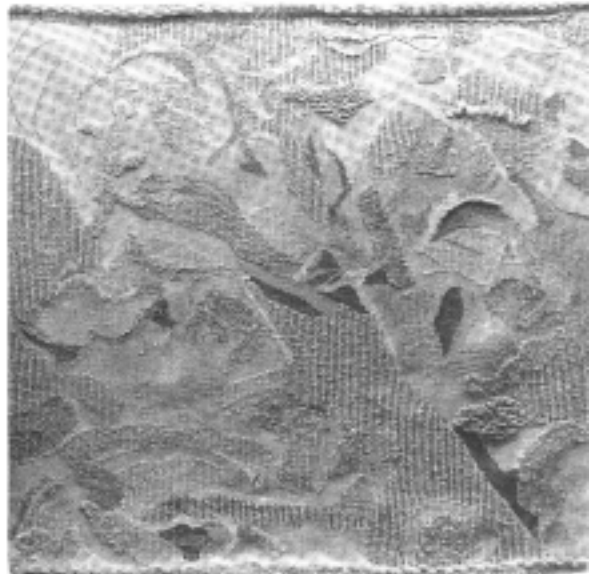

"De La Mer Soi Meme" © 1979

The next year was spent on larger pieces, scaling the dimension to the subject of the land. **Earth Memory**, which is in the blacks and whites of a Greek vase, is a dark allegory of the earth's memory stones and fossilized bones. There is in it a fetal form of a mythical beast with ram's head and fish tail, with wing forms nearby, and to the left the form of a large pelvis, which girdles the womb. This piece was based on studies of a slab of exfoliating granite.

New World is an allegory about the beginning of earth's life. The overall design was derived from the entrance to a cave in the remote Australian desert, which seemed like an entrance to the earth's womb. At the same time it appeared to be a shape like a world itself, with continents beginning to form upon it. It is in heavy white textured weaves and a flat grey linen, as though color were a later development.

De La Mer Soi Meme is a rendition of a fossil shell bed with the ghostly figure of a tree growing through it, symbolizing the stored memories of the earth.

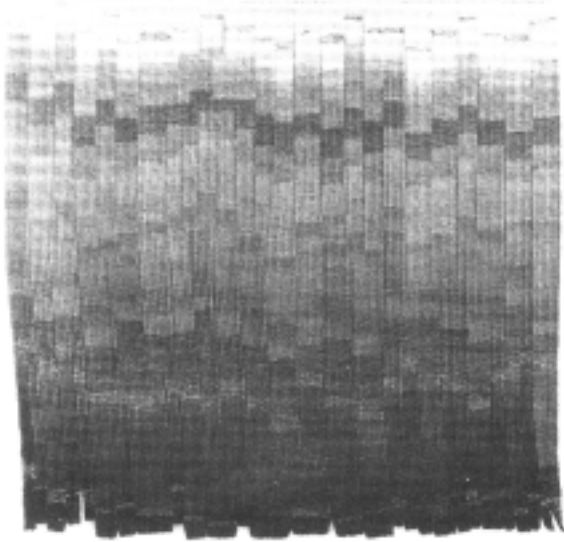

"The Rich, Red Earth" © 1980

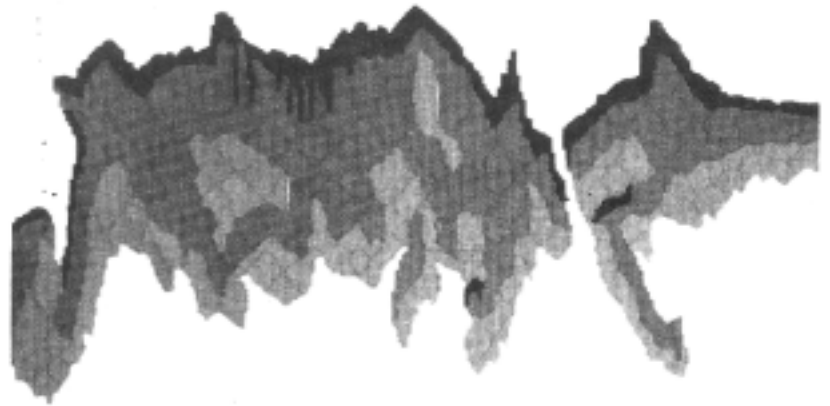

"Mountains of the Middle Kingdom I" © 1980



"Les Amants du Bois" © 1980

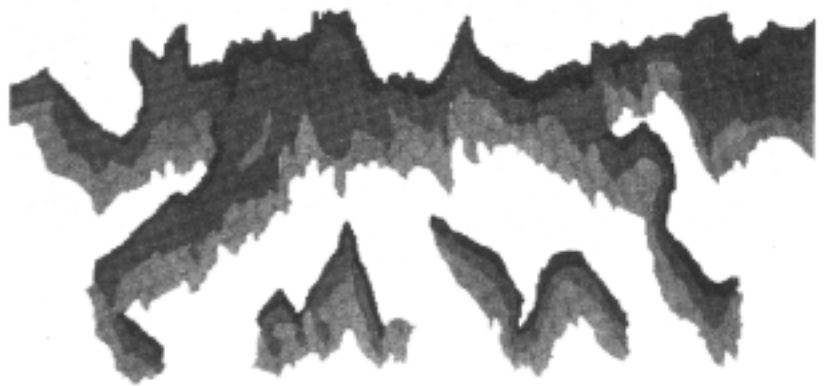

"Mountains of the Middle Kingdom II" © 1980

The Rich Red Earth is a sketch in horizontals and verticals, an out-of-register plaid, of the color emanations of the earth, from the deepest ground water blue in black to the burning surfaces of red and yellow.

Les Amants du Bois is a "woodcut print" rendering of a design I discovered in a piece of driftwood which seemed to contain a male form and a female form; perhaps an unlucky pair who were turned into a tree for offending a god and later revealed by the action of wind and water. Earth hides and reveals herself to us in turn, if we choose to seek her and try to understand her.

Mountains of the Middle Kingdom I and II are a crystallizing landscape of amethyst mountains, which in their remoteness and inaccessibility call to mind Tibet and other hidden kindgoms in the world and express the inaccessibility of the earth's nature.

Copyright—Kate O'Callaghan



Sweater jacket using color progressions

THREE COLOR PROGRESSIONS AND THEIR USE IN SWEATER JACKETS

by Katherine Sylvan

My fascination with color, my increasing expertise in the use of acid dyes, and a need for some outer garments that visually reduce my girth, have led me through some experiments in color progressions in a series of sweater jackets. These garments are all in the same style but with variations of cuffs, hoods and front closings. The color progressions give a more subtle effect than hard-edged stripes, and on a long warp make the weaving process more interesting.

Three of the color progressions I have been working on for many years throughout all my projects, functional and non-functional, are pictured in Photo 1. I thought I had invented or evolved the first two progressions until my design eye became more discerning and I then noticed these progressions in paintings and others' textile work. Rediscovering "my" inventions elsewhere is always a humbling experience. I initially saw the third progression in a modern art gallery of a museum where I scribbled it down. I have used it extensively, and have since learned that it is the Fibonacci Series, described in depth in a previous *Weaver's Journal* article.¹

These color progressions serve as bridges from one color to another, a way of softening the effect of stripes, of giving the eye a chance to adjust from one color area to another.

Sometimes I use just one of the three bridges. If I am working with a complicated series of colors or yarn textures, I will combine all three progressions. For example, the two yarns in Photo 1 (Harrisville 2-ply Black and White), could very well have been a range of black, grays and white in a variety of textured yarns. This is what I chose to do in the jacket in Photo 2.

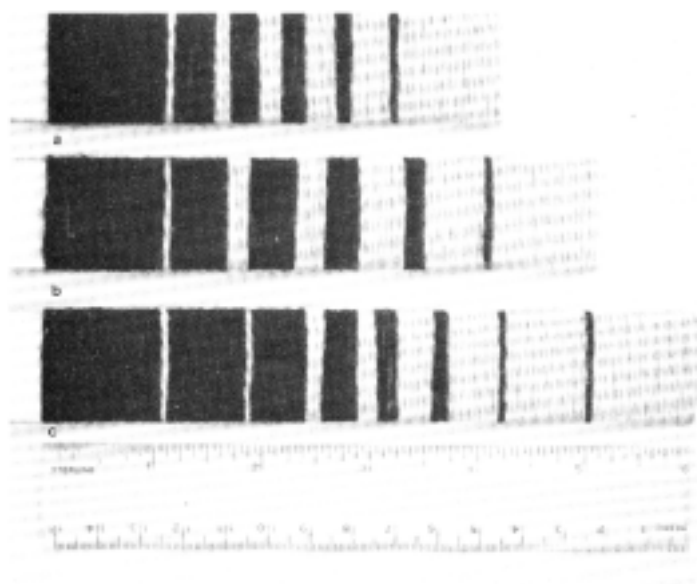

- a. progression 1,2,3,4,5
- b. progression 1,3,5,7,9
- c. progression 1,1,2,3,5,8,13

1. Three color progressions



2. Black and white sweater jacket



3. Sweater jacket using the principle of color progression and Summer and Winter patterning

The jacket in Photo 3 shows the use of Progression c, with Summer and Winter patterning for the border, along the center front, hood and cuffs.

If you are interested in working with the color progressions, begin by using 1" x 10" (2.5 x 25 cm) strips of stiff cardboard and attach pieces of double-backed tape to each side of the cardboard to hold the winding yarns in place. Begin this process with black and white yarns because the value areas are distinct and it is easier to notice if you make a mistake in the winding sequence. Yarn "A" is black and yarn "B" is white. Each letter "A" and "B" in the following sequences will indicate the winding of one black or one white, respectively. Wind one inch (25 mm) of black before you actually begin a sequence, and finish with one inch of white after you have completed a sequence.

PROGRESSION a. Each successive number is one more than the previous one. (1,2,3,4,5).

One inch black, B AAAAA BB AAAA BBB AAA BBBB AA BBBB A, one inch white.

PROGRESSION b. Numbers increase by two digits. (1,3,5,7,9).

One inch black, B AAAAAAAAA BBB AAAAA BBBB AAAAA BBBB AAA BBBB A, one inch white.

PROGRESSION c. The last two numbers are added together to arrive at the next. (0,1,1,2,3,5,8,13).

One inch black, B AAAAAAAAAA B AAAAA BB AAAAA BBB AAA BBBB AA BBBB A BBBB A, one inch white.

Progression a. is good for short distances. Progression c. takes a little more time, but it is the most refined or sophisticated of the three and gives the most subtle blending.

For purposes of keeping the samples of Photo 1 as simple as possible, I chose to go only as far as the number 5 in a., the number 9 in b., and the number 13 in c. The progressions can, of course, continue on into higher numbers.

This process becomes more complicated with many colors and textures, so it is a good idea to practice winding the cardboard pieces first. Once you have mastered the three progressions in black and white, then go to color and the added dimension of a variety of textures. Sometimes I find that the yarns I have collected and then neglected for years

become true friends when I need an unusual texture or “off” color during the blending process. I have learned to respect all my yarns, even the “uglies” for their ability to rescue a progression that is giving me a hard time.

If I am working with a large area of solid color, say twenty inches (51 cm) of rust, before the progression of rust to browns actually begins, I will insert a fine yarn (either sewing thread or worsted weight) of a complementary color, in this case blue or blue-violet. This insertion of even one or two threads spaced several inches apart in the large area of rust will add subtle visual interest to an otherwise monotonous section of warp or weft.

Now to the sweater jackets where I have used the color progressions in the warp. I learned this design in the “Garment Design Workshop” with Jean Sullivan of Seattle, Washington. Jean’s “old standby” is a variation on the bog jacket. It is done in two rectangles, and the warp width is the sleeve circumference. The arrow indicates warp direction in Fig. 1.

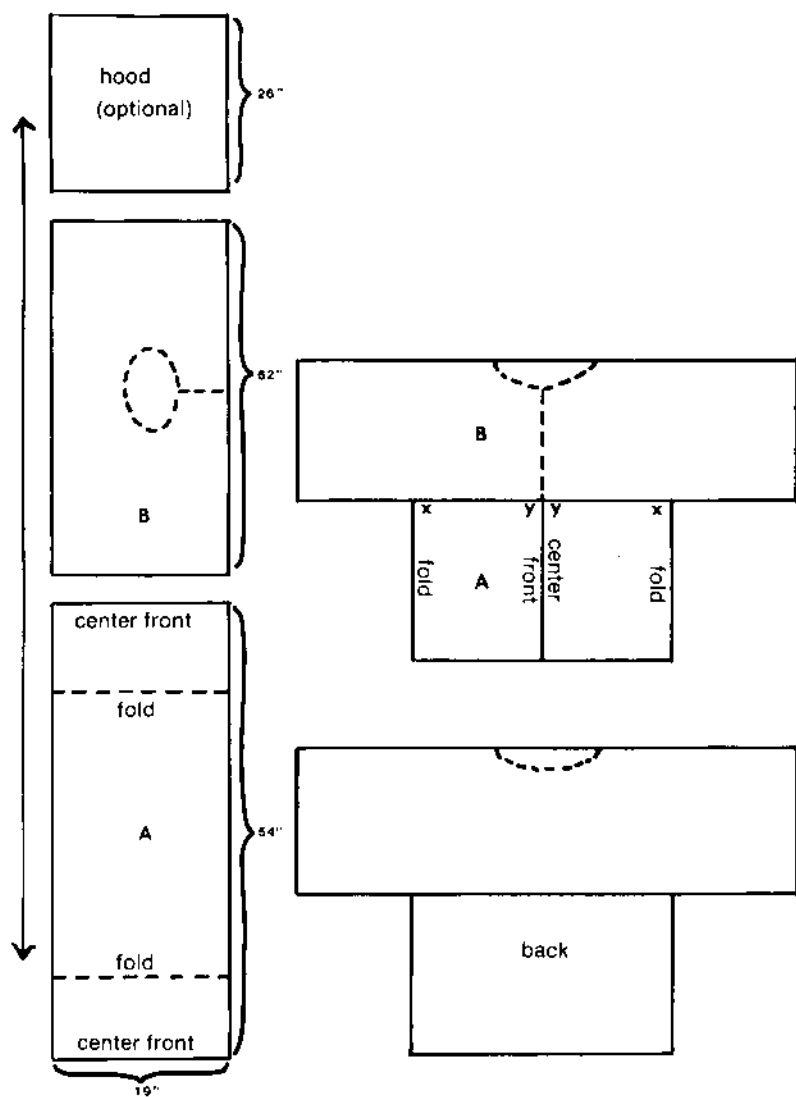

FIGURE 1. Layout of jacket pieces

The measurements given in Fig. 1 fit my frame. I am a size 12 and have short arms. For longer arms or for folded-over cuffs, add more to the length of B.

The warp length of A allows enough room for ease across the bustline and across the back.

When preparing my warps for the jackets, I must decide ahead of time where I want the blending to appear in the final jacket, and whether I want to use a weft patterned border in addition to the warp blending. The jacket in Photo 3 has warp blending and a summer/winter border along the cuffs, center front and around the hood.

I must also decide how I want to assemble A and B—with the dark end of the spectrum meeting in front or with the lighter edges of the pieces meeting in front. See Fig. 2. I have found that the *b* design is more slimming and I tend to use it the most. Sweater jackets woven of lighter yarns, cottons or rayon blends, and worn over lighter-colored pants or skirts, are more attractive when they are assembled as in the *a* design.

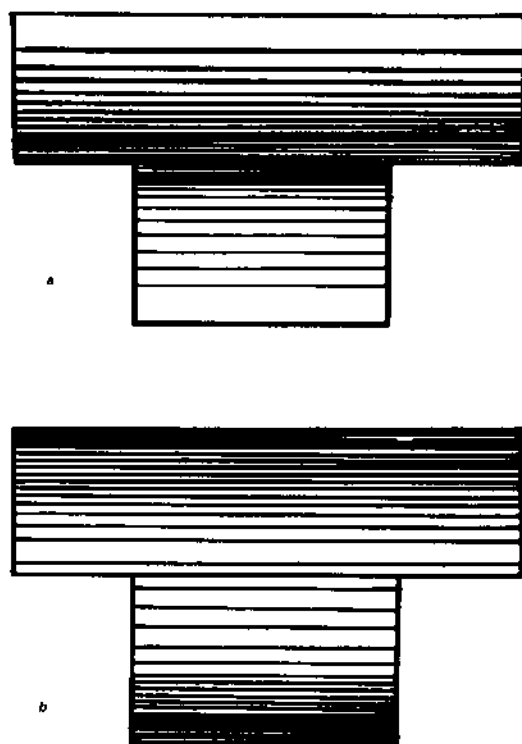

FIGURE 2. Two ways of assembling jacket pieces



Sweater jacket using color progressions

BLACK/WHITE SWEATER JACKET

WARP: Harrisville 2-ply Black, White, Suede; black looped mohair blend from Straw into Gold; black/white/gray seed novelty wool yarn from Old Mill Yarns.

WEFT: Harrisville 2-ply Suede.

SETT: 12 epi (15/10 cm)

REED: 8-dent (30/10 cm) It was necessary to use a wide-spaced reed because the nubs in the seed yarn were large and tended to get caught in my metal heddles and any reed smaller than the 8-dent.

WIDTH IN REED: 19 in. (48 cm)

WARP LENGTH: 180 in. (457 cm) includes hood.

THREADING AND TIE-UP: See Fig. 3.

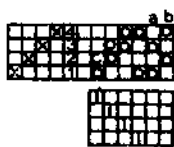

FIGURE 3. Threading, tie-up and treadling

WEAVING PROCESS, FULLING AND ASSEMBLY: I used a twill treadling in the arm sections of piece B for greater drapability. The rest of the weaving was done in tabby.

After the three pieces were woven and before they were separated from each other, I machine zigzagged across the edges that would be cut.

I have a cardboard set of neckline patterns taken from commercial patterns: oval, round, square and rectangular. If I will be attaching a hood to the jacket as in the case of this black/white jacket, I choose the oval pattern, since it is easier to attach a hood to a rounded neckline. I hold the cardboard pattern against piece B and machine zigzag around the neckline as in the dotted lines in piece B of Fig. 1.

I then cut the three pieces apart and fulling them by placing them in the washing machine which had been prefilled with warm water containing Ivory Liquid detergent. After the three pieces soaked for two hours, I agitated the machine on the gentle cycle for two minutes and then rinsed the pieces by lifting them out of the soapy water, refilling the machine with clear, warm water, agitating the pieces in the rinse water for ten to fifteen seconds, lifting them out and again repeating the process until the rinse water was clear. At no time did I let the machine go through the spin cycle with the jacket pieces, for I didn't want any wrinkles to be forced into the fabric. I rolled the pieces in towels to soak up the excess moisture, removed them from the towels and laid them flat to dry.

The black/white jacket was assembled with crocheting. I single crocheted around all three pieces with the black yarn, knitted the cuffs, and then whipstitched the three pieces to each other. The length of the seam from the underarm to center front is nine inches (23 cm) (x to y), and across the back underarm to underarm (x to x) the seam length is twenty inches (51 cm). These numbers would have to be adjusted for larger or smaller sizes. I did a little gathering of piece A across the bustline and across the back.

I added braids made from the black yarn as closures at the neckline and bustline. A final hand pressing gave the jacket a finished look.

Reference

- Templeton, Peg, Geometric Proportions as a Design Tool, *The Weaver's Journal*, Vol. IV No. 4, April 1980, p. 8.
- Hale, Nathan C., *Abstractions in Art and Nature*, Watson Guptill, 1972.
- Garrett, Lillian, *Visual Design—A Problem-Solving Approach*, Van Nostrand Reinhold, 1967.

A LOW BUDGET TAPESTRY LOOM



by Bill and Sara Gilstrap

photo by Sara Gilstrap

Deborah Hamilton weaving on the low budget tapestry loom

A few years ago when the need arose for a low cost loom in the classroom, we put our heads together and came up with one that has proven itself over several years use in the Art Department of Midland College. It had to be inexpensive, practical and easy to build. Although our original concern in design was for the beginning student, we have found the loom useful at advanced levels also. Good creative students continue to produce nice pieces on this loom. By learning basic tapestry techniques first, a student is better equipped to handle the complex mechanics of the four harness looms also used at the College.

Construction is easy. If you decide to build one, be sure to shop around for the parts. There can be a wide difference in charges at various lumber outlets, but the average for all the parts should be \$12 to \$15. If the loom is to be used in a classroom, it is nice to have the student build his own. At Midland College, each beginning student brings the parts to class, and they build them together. At the end of the semester they are theirs to take home. Hardly any tools are required: a small wrench or pliers and a drill of the right size. Using pre-cut lumber, a loom can be built in thirty minutes. The builder is not strapped in to the dimensions

A LOW BUDGET TAPESTRY LOOM

Notes: Top 1" x 4" is loose. Tension on warp is increased by driving wedges. Base stands are loose and can be removed for storing.

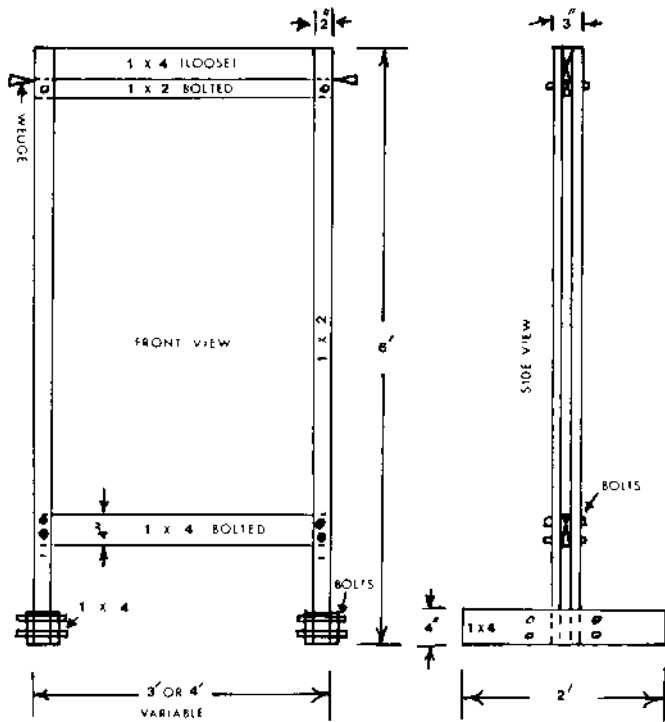

Materials List (48" wide)

Lumber:

- 4 1" x 2" x 6' long
- 1 1" x 2" x 4' long
- 2 1" x 2" x 1' long
- 2 1" x 4" x 4' long
- 4 1" x 4" x 2' long

Bolts, nuts, washers:

- 4 3/2" x 1/4" bolts
- 6 2 1/2" x 1/4" bolts
- 10 1/2" nuts
- 14 1/4" washers

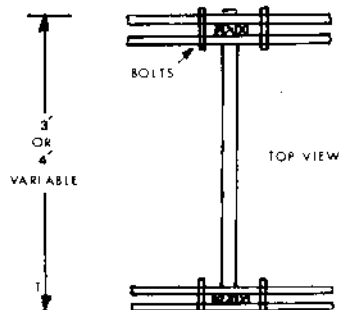

Materials List (36" wide)

Lumber:

- 4 1" x 2" x 6' long
- 1 1" x 2" x 3' long
- 2 1" x 2" x 1' long
- 2 1" x 4" x 3' long
- 4 1" x 4" x 2' long

Bolts, nuts, washers: Same as above.

shown here. They can be altered in either direction with no loss of quality.

Design is simple. It is a double 1" x 2" (25 x 50 mm) frame standing on detachable feet and tensioned by wedges at the top. We designed the feet, but the wedges are borrowed from a Grau-Garriga workshop of a few years ago. The feet are removable, and storing is compact. Remove a few small bolts, and it's even better. Time permitting, one can sand and stain the loom for a more finished look.

Warping is fast. Wrap the yarn round and round, up the front, over the top and down the back. This method gives a double layered warp, and single double and multiple weaves are possible. Notches 1/4" (6.3 mm) apart at both top and bottom keep the warp in place. Warping every second notch leaves a nice spacing, and the unused notches are available for supplemental warping later in the development of the piece. After warping, the wedges are driven in for tension.

Possible variations in construction are numerous: different tension devices, other ways of warping, and so on. The builder can use his personal preferences. We tried to make ours simple, strong and light weight. It works well for us, and it could for you.

Erratum

Issue 19,
Winter 1981

Tulip outfit,
p. 30

Section 2: Skirt Front

3 1/2" plain
1-8" or 3 picks Island green
16 picks plain
tulips/repeat yellow, red, blue
sequence in all areas a - l
3 5/8" }
16 picks plain
1-8" or 3 picks Island green
3 5/8" plain
1-8" or 3 picks Island green
3 5/8" plain
1-8" or 3 picks Island green
1 1/2" plain

BOOK REVIEWS

THE BOOK OF LOOMS by Eric Broudy © 1979. Published by Van Nostrand Reinhold Co., New York, NY. 8½" x 10¾", 176 pp., hardcover, \$16.95.

Anyone whose occupation or hobby calls for a loom develops a natural curiosity about the origin and the development of this piece of equipment. How did the different types of looms evolve and which variations of the loom are used today by the contemporary craftsman and by various ethnic groups? The answers to this question can be found in this well illustrated and well researched *Book of Looms*.

The basic principles of the loom are thousands of years old and can be found among various cultures all over the world. Texts on looms have been written before but are often out of print, inaccessible or are highly specialized. Here the author brings it all together in a comprehensive book that deals with all major types of looms from their origin to modern times. The looms are classified as warp weighted looms, two bar looms, Pueblo and Navajo looms, backstrap and primitive looms, treadle looms, draw looms and modern looms. The earlier looms are discussed with prehistorical and historical documentation. All looms are illustrated with drawings or photographs.

The looms are described with a great deal of concern for accuracy. The reader becomes aware of the importance of each part, the economy of the design, the adaptability of their function and the ingenuity of the people who use them.

This is truly a fascinating book and weavers will enjoy using it for reference. Now the weavers can spend delightful hours read-

ing about the history of the most important piece of equipment of their trade.

Clotilde Barrett

HANDLOOM WEAVING TECHNOLOGY by Allen A. Fannin © 1979. Published by Van Nostrand Reinhold Co., New York, NY. 6¾" x 10", 336 p., hardcover, \$26.50.

This is the book for the weaver who wants to approach his craft with the proper knowledge of his equipment, his materials, loom dressing and weaving vocabulary. The author's concern for productivity and high standards in handweaving is felt all through this very precise and technical book.

With the help of this book a craftsperson who is concerned about his equipment and his tools will learn about the parts of the loom, their function and the adjustments which should be made for greater productivity. The author sets standards by which one can compare one's own work habits.

Handlooms were, not so long time ago, the professional equipment of the weaver's trade. The industry has brought great changes to the loom but the handweaver, at least in the U.S., uses equipment that has not been improved by industrial innovations and that is often inferior to the looms of his ancestors. Allen Fannin takes a look at the contemporary weaving industry and points out what the handweaver can learn from it in order to adjust his equipment for better productivity.

The first chapters are devoted to fiber technology, yarn count, yarn classification and yarn packaging. This is a valuable ref-

erence text as there is little precise information available on that subject in other handweaving books. In the following chapter the loom is studied in all of its parts. Most loom parts come with detailed construction plans. Their action is discussed and also the advantages of one mechanism over the other. Of the more complex looms, only the dobby harness motion is discussed, not the drawloom.

In addition to the treatment of the loom and the yarn, there is also an in-depth discussion of tools, including the fly-shuttle, shuttles, hooks, scissors, reels, swifts and warp dressing equipment.

Many chapters are devoted to efficient and productive ways to prepare warps, dress the loom, to weave and to keep records.

This is an authoritative text and encourages a professional attitude toward loom weaving.

Clotilde Barrett

THE LEGACY OF THE GREAT WHEEL by Katy Turner © 1980 Kathryn Turner. Published by Select Books, Mountain View, MO. 8½" x 5½" format, 128 pp., \$8.95.

There is a great deal of information in this book and no spinner should be without it.

First there is a historical introduction to spinning which includes fibers and tools. Then follows a series of chapters devoted exclusively to the great wheel. These include a study of its parts and their function, the operation of the wheel and step-by-step instructions on the spinning of wool.

The author addresses herself both to the beginner and to the advanced spinner. She goes into a great deal of detail about quality of the fiber, the preparation of the fiber for spinning, the entire spinning process and the final finishing of the yarn.

Special chapters are devoted to flax, cotton, silk and other fibers.

A glossary, bibliography and index contribute to the value of this book as a good reference text on the subject of the great wheel.

Clotilde Barrett

SLING BRAIDING OF THE ANDES by Adele Cahlander, with Elayne Zorn and Ann Pollard Rowe; *Weaver's Journal* Monograph IV, © 1980 Adele Cahlander. Published by Colorado Fiber Center, Boulder, Colo. 96 pp, softcover, \$11.00 ppd.

"Even thousands of years before the time of David and Goliath, slings were used as weapons," Adele Cahlander reminds us in her intriguing study, *Sling Braiding in the Andes*. Around the globe archaeologists have found evidence of their use in early warfare, for hunting, and for herding livestock. In Andean history, more elaborate and ornamental slings, sometimes up to 28 feet long, were commonly exhibited during ceremonies. However, it was not until the late 1970s that

the mystery of the complex braiding structure of the sling was unravelled.

Drawing on the field work of Elayne Zorn and the expertise of Ann Pollard Rowe, Cahlander has produced a book which combines documentation and instruction, of value to both scholars and fibre artists. With admirable clarity, considering the complexity of her objective, Cahlander guides the uninitiated through the sling-making process. For this purpose she has developed a bi-level squared grid for pattern reproduction, and a series of rectangles to record braiding sequence. This enables her to explain even the most complicated sling braids, from the four-strand to the thirty-two-strand braid, using a variety of coloured yarns, in both symmetrical and asymmetrical patterns. The possibilities are virtually infinite. The practical application for the fibre artist are equally intriguing: decorative ties for garments, drawstrings, small wall or door hangings—even a dog harness or leash.

Sling Braiding of the Andes is more than just an instructional guide. Coloured photographs of the slings in their Andean setting, numerous black and white shots illustrating the manipulation of the yarns, and endless diagrams made the book a visual treat, a useful resource and—above all—an enticement to plunge in.

Joyce Aster

THE WEAVING BOOK OF PEACE AND PATIENCE compiled by Isadora Safner and Diane Piette © 1980. Two Cape Cod Weavers, P. O. Box 186, Brewster, MA 02631. 8½" x 11", 76 pp., \$9.95 + \$1.00 P/H.

This book is the outcome of an interesting project done by Cape Cod weavers who had access to the weaving drafts in the possession of the Old Sturbridge Village, Mass. and which date from around 1800. There are about 30 drafts ranging from 4- to 6-shaft patterns. They include overshot, Summer and Winter, Spot weaves and M's and O's. The drafts were studied and samples woven. The photos of the woven pieces reveal some beautiful patterns but the draft information that goes with it is sparse and sometimes inaccurate. The treadling is always noted as "as drawn in"; an expression which can have several interpretations as seen in sample 26-60-1-8 which is not woven in typical overshot fashion. Another confusing element is the position of profile drafts under the heading of threading. In draft 26-60-1-10 this leads to an erroneous warp count.

An errata is provided to line up four of the drafts with their correct samples. In spite of the fact that this first edition has a few problems, not the least that the pages are not numbered, this book contains a nice set of patterns for those interested in Colonial weaves.

Clotilde Barrett

ORDER ALL YOUR WEAVING, SPINNING, DYEING BOOKS AT DISCOUNT

Any good, standard Classics and many New Titles
Also Needlework, Hobbies, Crafts, Dolls, Miniatures
10% discount on any U.S. books

KATHERINE RAMUS 2100 E. EASTMAN AVE., ENGLEWOOD, CO 80110

"COCOON" HAMMOCK

by Penelope B. Drooker

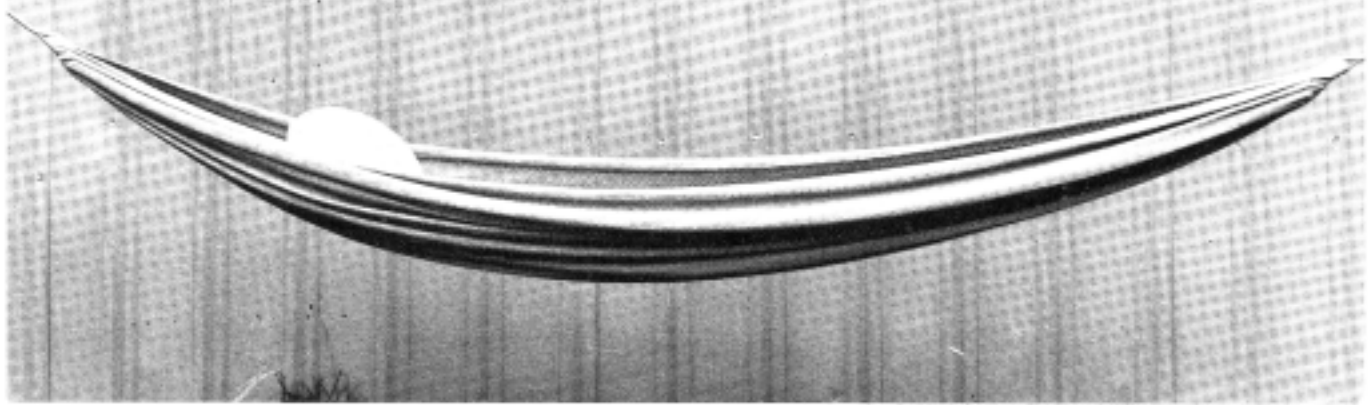

The shape of this hammock is designed so that when you lie in the hammock, it folds around you and encloses you. Any supple but strong fabric can be used to make it, but the version pictured here was woven in a doup leno pattern illustrated in *The Two-Harness Textiles: The Open-Work Weaves*, by Harriet Tidball.

Leno is a fabric in which some warp threads are manipulated to cross over other warp threads and to be held in place with the weft. This manipulation can be done by hand, or with the aid of string half-heddles or "doups" fastened on to one of the shafts of your loom. The technique of doup leno is described in "Doup Leno", *The Weaver's Journal*, October 1978, pp. 32-39. For this project, doups were attached to the bottom heddle bar, as described on pages 35-36 of that article.

TOTAL NUMBER OF ENDS: 910.

LENGTH OF WARP: 6 yards (5.5 m).

NUMBER OF PICKS PER INCH: 7 ppi (30: 10 cm).

THREADING, TIE-UP AND TREADLING: See Fig. 1.

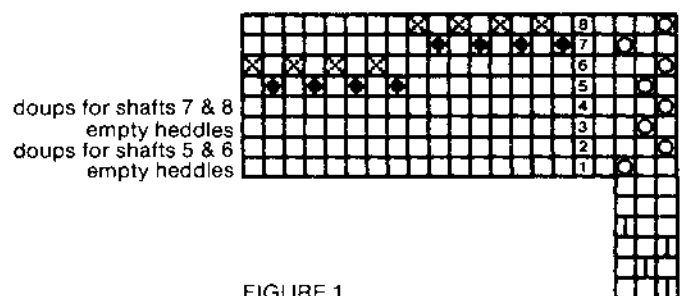
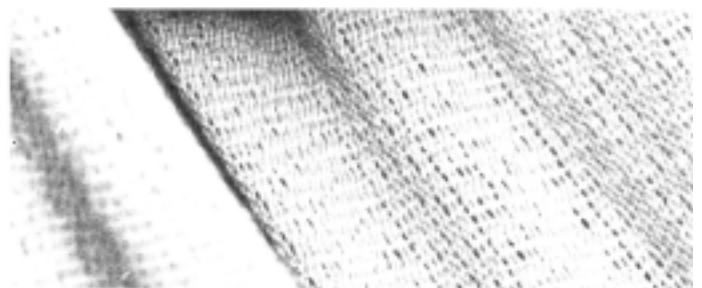

FIGURE 1

Detail



WARP AND WEFT: 5/2 perle cotton.

SETT: 20 (80/10 cm) epi in a 10 (40/10 cm) dent reed.

An eight-foot (2.44 m) length of fabric was woven for the bed of the hammock. After the piece was cut off the loom, its raw ends were machine stitched, trimmed, and turned under; then a two-inch hem or casing was sewn on each end of the fabric.

The hanging "ropes" for this particular hammock were made of two one-yard (91.5 cm) skeins of 3/2 cotton, about 3/8 inch (9.5 mm) in diameter when squeezed together. Individually, these skeins were stretched out, then tightly wrapped with more 3/2 cotton. The end loops, also wrapped, were shaped around small metal tear-drop-shaped "thimbles" (metal devices used on sailboats, obtainable at hardware stores). See Fig. 2. Alternatively, plied ropes with two looped ends could be made using the Schacht "rope machine". (Wrapping was used here to echo the smoothness of the satin pillow which lies on the hammock).

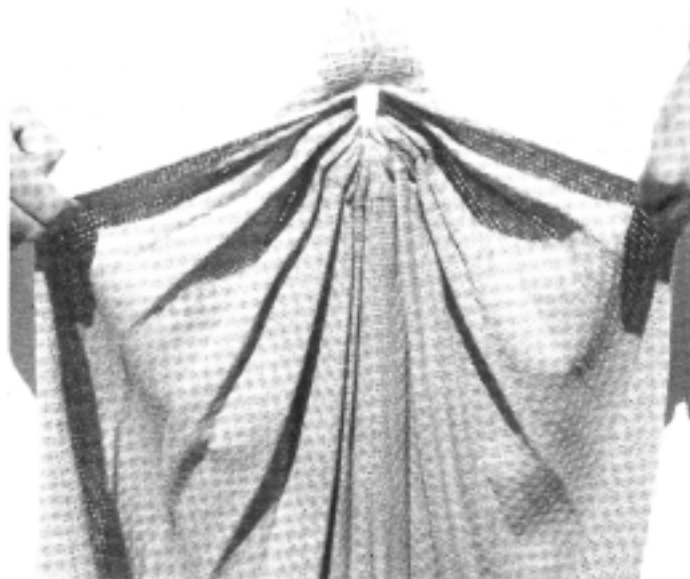

Connection between the bed of the hammock and the hanging rope.

selvedge, edges of the fabric are stretched more tightly than the middle of the fabric, resulting in the "cocoon" shape.

To complement the hammock, I wove a five-harness satin pillow with a picked up design showing a luna moth.

*Two mailorder sources: Recreational Equipment, Inc., 1525 11th Ave., P.O. Box C88125, Seattle, WA 98188, and Eastern Mountain Sports, Inc., Vose Farm Road, Peterborough, NH 03158.

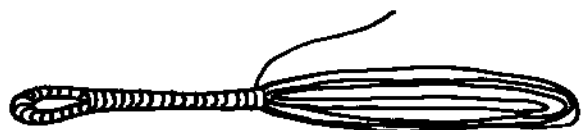

FIGURE 2. Hanging rope, showing wrapping in progress. One "thimble" shown inserted and covered by wrapping. Second "thimble" to be inserted in opposite end.

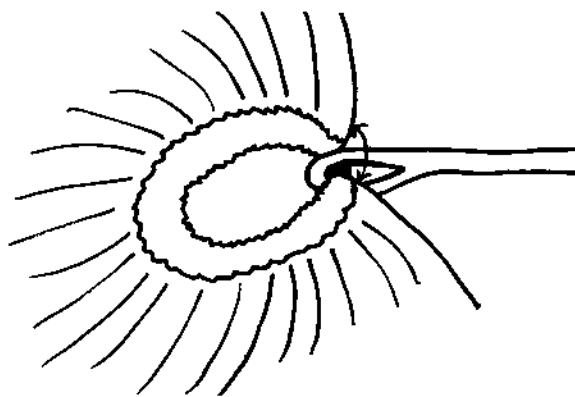

FIGURE 3. Inside view of carabiner enclosed by casing, with hammock fabric spread out. Arrows indicate selvedge edges to be brought together and sewn.

Two 3/2 inch oval carabiners (metal rings which snap open and shut, obtainable at mountain-climbing supply stores*) were used as end pieces. One was inserted through the casing at each end of the fabric, then a hanging rope was also threaded onto each carabiner (See Fig. 3). Finally, the selvedge ends of the fabric were pulled completely around the carabiner so that they met on either side of the hanging rope; they were sewn together (except for an opening for the hanging rope) with the hem to the inside of the oval loop, so that the carabiner was completely covered by fabric. Thus, when the hammock is hung, the

July 15-18, 1982

convergence 
seattle 

2161 East Hamlin Seattle, Washington 98112

FROM COTTON PATCH TO COTTON PATCHES AND THEN SOME

by Olive Linder

photo by Cynthia Cielle

If it were not for Ralph Baskett III, this story could not be written. In the large philosophical view, it is because Ralph is a cotton rancher. Were it not for him and all the others who grow cotton, there would be no denim, or blue jeans, or Levis. And, in the very immediate aspect, if Ralph Baskett III were not a rancher who grew cotton and wore blue jeans as he worked, we could go no further.

It all began when Martha, who is Ralph's wife, came into the studio and said in a tone of despair, "What can be done with thirty-two pairs of worn-out blue jeans?"

A vision of heaven flashed through the mind of the weaver: unlimited raw materials and a possibly highly motivated slave labor pool asking for advice.

"Martha", said the weaver, "You need a rug."

Martha replied, "Why yes. I *do* need a rug. My father is coming to visit us and the guest room needs a rug."

So Martha agreed to cut the worn-out blue denims exactly as instructed and sew them together again in precise order. That was all she had to do. The weaver would make her a rug.

The trousers had indeed been well worn. Sun bleached, oil-spattered, threadbare in spots and tastefully eaten here and there with battery acid, thorny plants and just plain hard work. Martha first removed all the pockets and laid them aside to make patches for future pants. The fly, the rivets and the small area pieces were removed and discarded. Seams were laid open and the material was cut into one-half inch wide strips on the lengthwise grain. A decision was made to leave the patches wherever they occurred on the theory that the original material was so thin the patch would not bulge in the weft. This appeared to be valid when the weaving began.

Of course, you can cut strips with scissors, but it is less laborious to cut with a rag cutter (the cutter that is sold by the Oriental Rug Co. of Lima, Ohio is a good one). Martha began cutting strips. She soon discovered that the job is monotonous, dusty, and time-consuming. But it is very important to a good rug to have well-prepared rags.

The strips of rag were then sewed together to make long rug filler. The sewing was done on the sewing machine. The strips were overlapped about a half inch and a straight seam was made down the middle. Then a shallow scoop was cut from the material on each side of the stitching to prevent a bulge in the fell line due to the double thickness.

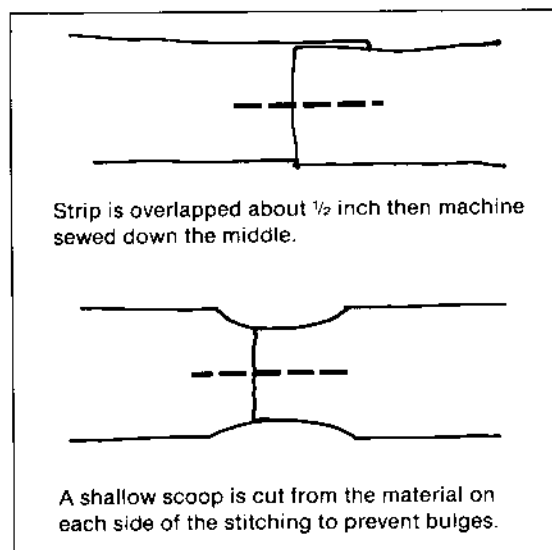

FIGURE 1

The criteria for a rag rug, according to the weaver, are: a dense fabric that will lie flat on the floor, have straight selvages that will remain sturdy under use, and have a well-finished fringe. It should be washable by machine and, hopefully, be machine dryable. It should wear for years and years. And it should be a warm, colorful thing of beauty and use.

With these criteria in mind, cotton carpet warp in two colors, canary yellow and rusty orange, was chosen for the warp yarn. A symmetrical block pattern in the Log Cabin technique was selected for the weaving plan. A rug 36 inches by 60 inches was desired.



As many weavers know, Log Cabin is well documented in many reliable books on weaving. It is threaded in a

straight draw (1-2-3-4) if you have a four-shaft loom, or can be woven on two shafts. The pattern blocks are achieved by threading two alternating colors. When a block change occurs, the color sequence alternates. So for Martha's rug, it was Rust-Yellow for block A, and Yellow-Rust for block B. Because the curtains in the room where the rug was to be used had a hint of green in them, a two thread stripe of green was put between the blocks as an accent. It is a two shuttle weave alternating a heavy weft with a thinner yarn: in this case blue denim rag strips and a yarn of the same color as the denim, a faded blue shade.

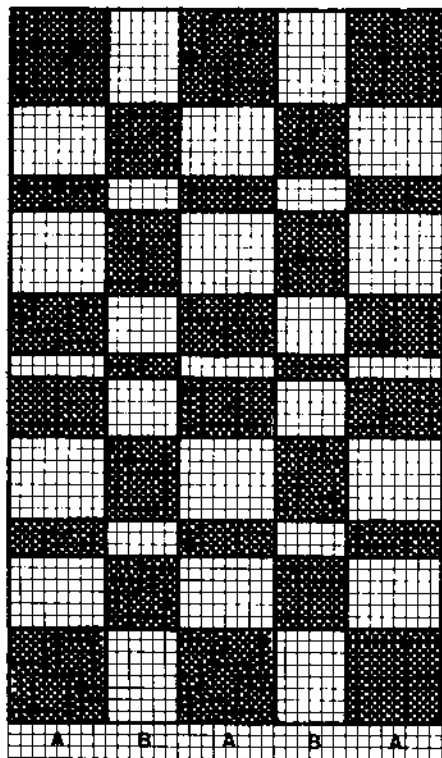

Working Diagram
1 square = 1 inch

FIGURE 2

We have already stated that a large part of the excellence of a rag rug is in the preparation of the rags. The next large part is in the sett of the warp. Martha's rug was sett 16 ends per inch (64/10cm) and sleyed 2 per dent in an 8 dent reed. This binds the filler in firmly and makes a firm, long-lasting rug.

When using two shuttles, it is sometimes a problem for a beginning weaver to keep the selvedge in order. This is one reason that a floating selvedge thread is a good idea with rug weaves. The other reason is that a reinforcement of a slightly heavier yarn at each edge is insurance for longer wear. If a rag rug is going to wear out before its allotted time, it will be on the selvedges or the fringe. Care taken in these areas will pay dividends.

In Martha's rug, a waxed linen floater was used on each edge. (A floating selvedge thread is not threaded in a heddle but passes through the reed. The shuttle goes over it on entering the shed and under it as it passes out of the shed.)

It is important with rugs to give enough fullness in the weft so the rug will lie flat and not buckle or pull in at the sides. Rather than a conventional bubbling as one does with yarn rugs, it is advisable to make a central peak or "mountain" in the center of the warp. It takes a little experimentation to decide just how high to peak the filler in order to get the desired amount of filler packed into the rug. Use a very hard beat on a closed shed. You cannot overbeat a rag rug.

To reinforce the fringes and prevent wear, one makes a twisted fringe. In each hand, twist three or four strands of warp in an S-twist and then cross and twist in a Z-twist. A sturdy plied fringe is thus achieved. A gathering knot at the end secures the ply and holds up well during washings and floor use.

Ralph told the weaver that Martha was mighty hard to live with while she was cutting and sewing rags. In all she cut and prepared ten pairs of blue jeans. And Martha swears she will never cut rags again. But we wonder. The finished rug, 36" x 60" (91 x 152 cm), weighed three pounds (1.35 kg) when it was ready to go home. This would lead one to believe that anyone with three pairs of blue jeans (of the size that fits Ralph) could make a rug. If you are planning to make one it is better to have too many rags than not enough.

And we wonder about Martha; she walked out with her new rug in her arms and enough cut and sewn rags for two

more rugs . . . we think she may weave some of her own and, if she does, the cutting will not seem such a high price to pay.

"A thing of beauty is a joy forever."

WARP: Cotton carpet warp, canary yellow (Y) and rusty orange (R) for the blocks, green for the stripes.

WEFT: Blue denim rag strips; thin cotton in a faded blue shade.

SETT: 16 epi, double sleyed in a 8 dent reed.

THREADING: Straight draw or plain weave.

COLOR ORDER:

(R-Y)	(Y-R)	(R-Y)	(Y-R)	(R-Y)
A	B	A	B	A

Each block alternates yellow and rust in a 1/1 order. Two green threads are threaded between the blocks.

WIDTH: 36"

WEAVE: Plain weave, alternating a thick and a thin weft, creating blocks by changing from thin-thick sequences to thick-thin sequences. ■

Handweaving With Robert and Roberta A TRULY EXCELLENT HOME STUDY PROGRAM

STARTING WITH VOLUME ONE, THE FOUNDATION SERIES OF ASSIGNMENTS INCLUDING EQUIPMENT, DESIGNING, FIBER, COLOR, DRAFTING & BUSINESS **PLUS** ESPECIALLY PLANNED **WEAVING PROJECTS** TO BUILD YOUR FUNDAMENTAL WEAVING KNOWLEDGE AND SKILLS.

VOLUME TWO, THREE & FOUR CONTINUE STEP BY STEP TO HELP YOU PROGRESS FAR BEYOND THE MANY WEAVERS WHO HAVE FLOUNDERED YEAR AFTER YEAR.

WRITE FOR FREE DETAILS INCLUDING AN INDEX TO
AYOTTES' DESIGNERY, DEPT. WJ, CENTER SANDWICH, N.H. 03227

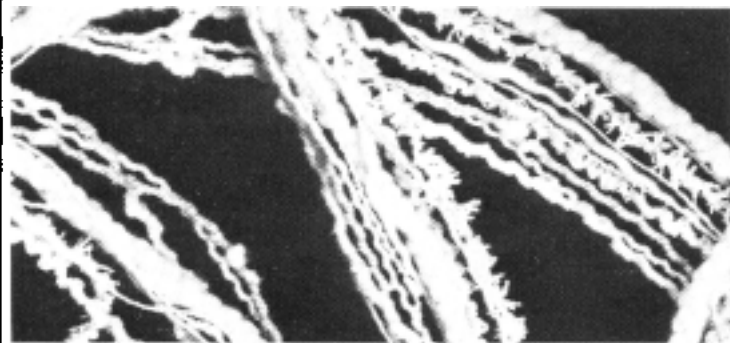

GRANDOR INDUSTRIES LTD.
Dept WJ, P.O. Box 5831, 4031 Knobhill Drive,
Sherman Oaks, CA. 91403. (213) 784-5855.

GRANDOR YARNS

British imports

COTTONS: Exotic (see picture) & 10/4 mercerised on 1/2 lb cones.
WOOL: Berbers, rovings & fine yarns, NEW LOOPED YARNS.

MOHAIR: NEW large looped yarn of 95% mohair, 5% wool

LINEN: Knop (see picture), cotton/linen. Warp yarns 4/6, 8/6, 10/6, 8/3, 12/3, 16/3 & colored 8/5s.

SILK: "SHANTUNG" range 65% silk & 35% wool. 10 colors, knitting patterns available. 100% silk tussah in 3 colors.

MORE EXOTIC YARNS . . . "SOFIA" & "CILICIA" in Colors: mohair or wool mixtures.

Domestic Supplies

****RIBBONS . . . RIBBONS . . . RIBBONS . . .** bias & straight cut. The latest fashion.

CHENILLE: 3 & 6 cut, natural & colors.

McMORRAN YARN BALANCE: still only \$13.95, discounts available.

"CLOTHING": Barbara Hamaker's book \$6.95, discounts available.

Please note: Yarns are wholesale only. Complete set of samples \$2.75.

PRODUCT REVIEWS

SUPER WEAVER.

Super Weaver is a computer program designed for the Apple Computer with at least 32K RAM and Applesoft in ROM and for the IDS 440 or Centronics printer. It is available as a diskette from MICROSPARC, INC Box 525, Lincoln, MA 01773 @ \$12.95 + \$1.50 P/H.

The program is designed to produce draw-downs for an 8-shaft (or less) loom in high resolution graphics. The program lets one analyse the design and the weave structure before putting the pattern on the loom. First the threading is entered (up to 80 threads), then the tie-up (up to 10 treadles) and finally the treadling (up to 80 picks). The draw-down such as shown in Fig. 1 appears on the screen. The "print the pattern" command will activate the printer and produce the draft shown in Fig. 2.



FIGURE 1

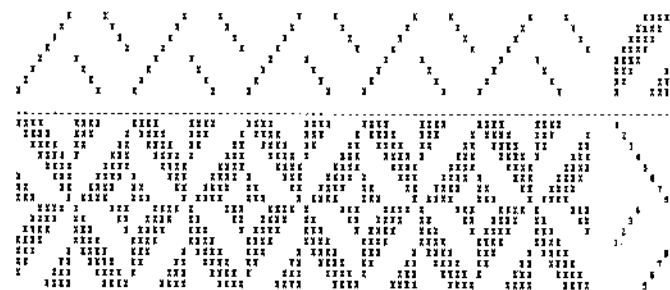

FIGURE 2

Some "debugging" of the program was necessary to get our newer-model IDS 460 printer to do this part correctly. It was necessary to delete Line 1 (which has no function anyway), the line-feed suppressors in Lines 1605 and 1830, and to insert one PRINT "CTRL-I K" command as Line 1517. It then worked fine.

The print-out presents great advantages for keeping records of weave structures and for evaluating their use. However, one must regret that the patterns are limited to 8 shafts and 10 treadles and that there is no provision for the study of color-and-weave effects.

The entire listing of this program has been published in NIBBLE, November 4, 1980 issue.

RIGBY CLOTH STRIPPING MACHINE—MODEL B

The handweaver calls it a rag cutter; the manufacturer calls it a cloth stripping machine, Model B, to distinguish it from other cloth strippers used by rug hookers and other crafts people. The Model B cuts strips from $\frac{1}{2}$ " to $1\frac{1}{2}$ " (1.27 to 4.75 cm) wide which are the sizes most suitable for weaving and braiding rugs. The machine clamps onto a table. The width of the strips is adjusted easily by loosening a wing nut. The cloth feeds between a circular cutter blade and a roller. The tension of the blade onto the roller is also adjustable.

The machine works well. By turning a crank, the cloth is fed in and cut in neat even strips.

The tool is available from Oriental Rug Co., P.O. Box 917, 214 S. Central Ave., Lima, Ohio 45802 or from D. Paulsen, P.O. Box 158, Bridgton, ME 04009, @ \$12.50 + shipping.

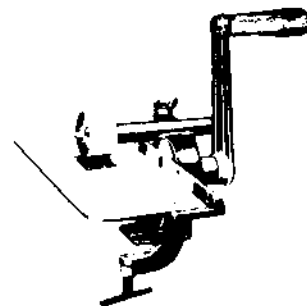

THE 12-SHAFT 36" FOLDING AND THE 16-SHAFT 48" PRODUCTION AHRENS AND VIOLETTE DOBBY LOOMS

A dobby loom is a loom equipped with a mechanism capable of being programmed to operate the shafts automatically. The Ahrens and Violette loom has a built-in dobby head which accepts wooden bars that are pegged according to a chosen pattern. Each bar (and its pegs) determines the shafts to be raised for one weft shot. A number of bars are fastened together to form a **harness chain** for a complete pattern. The dobby mechanism includes a rotatable drum with grooves into which the bars fit. As the drum is rotated by the action of the treadles, the bars are successively brought into a position where the pegs activate the levers which engage the harness lifting cords. The 16-shaft dobby includes a reversing mechanism which can be used to reduce the number of bars needed in a pattern.

The Ahrens and Violette looms are equipped with white Swedish polyester knit heddles packaged open in one long continuous string. Each unit has one long slit, a short slit for the heddle eye, another long slit, then a single strand which joins it to the next heddle. The heddles are placed on the heddle bars through the long slit areas so that loops

are formed above the upper heddle bar and below the lower one. The directions that come with the heddles from Sweden recommend cutting these loops exactly in half both bottom and top so that the heddle may slide easily along the heddle sticks.

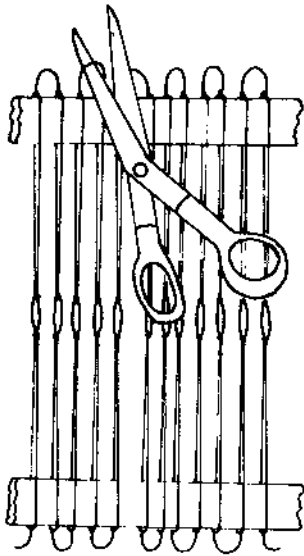

polyester knit heddles

The shafts on both dobby looms are suspended by aircraft wire which may be attached or detached easily via a hook and eye mechanism. The shaft is composed of two wooden sticks, the polyester heddles, and wire rods which slide down into holes to stabilize the shaft. The result is an extremely light weight shaft.

A special spring-loaded shaft return system is used to return the shaft quickly to its rest position after being raised, thus eliminating a "gravity-powered" return.

The light weight of the shafts combined with the spring lever return system produces an extremely easy action even when 15 shafts are lifted against 1!

As in all looms equipped with free hanging shafts, certain warps will pull the shafts forward when the warp is advanced. It is necessary to push the shafts back, especially on the 12-shaft loom, as the front shaft will catch and prevent proper action. The 12-shaft loom has a much more noisy return than the 16-shaft loom.

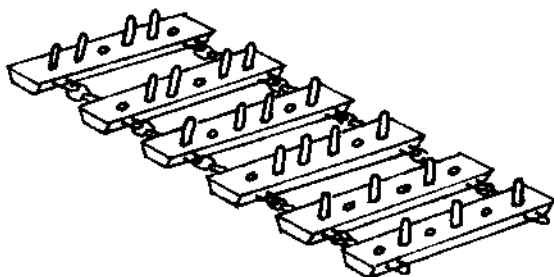

dobby bars and pegs



The wooden bars and metal pegs, which are easily screwed in, are the basis for the dobby pattern system. These bars have a flat side and a molded side. The molded side fits into the slots in the dobby head. Care must be taken to peg the bars on the *flat* side, otherwise the bars will not fit into the slots on the dobby head.

Each of the bars is joined together by metal loops and eyes. As it is necessary to separate the bars to form different sized chains, two pairs of pliers are needed to unfasten the metal loops which are then removed.

The difference between the dobby and a treadle operated loom is in the "tie-up" procedure. The treadle loom is tied up using a combination of shafts tied to produce a shed which forms one line of the pattern. The remaining treadles may be tied up to complete the pattern repeat and any treadle may be repeated as needed. The variation in tie-ups is restricted to the number of treadles available on the loom or to a combination that may be used employing two feet at once. With the dobby loom this tie-up process is virtually eliminated and total pattern selection is available with the use of just two treadles.

One peg is screwed into the dobby bar for each shaft that is to be used in the pattern. For example, if the treadle-to-shaft tie-up is 1,4,5,7,8 the dobby bar will be pegged 1,4,5,7,8 for the 16-shaft AV dobby loom or 2,3,6,9,10,11,12 (compare sinking shed loom) for the 12-shaft AV dobby. Each pattern shot needed for the complete pattern repeat (including tabby shots) must be pegged on the dobby. On the dobby head of the 16-shaft loom, a small knotted cord may be pulled out or released to effect a reverse action at any time. This feature is not present on the 12-shaft loom.

If a draw-down of the weave is available it is possible to block off a "one repeat" section and peg the dobby bars exactly according to the draw-down.

Of the two pedals that are used on the dobbies, the right pedal activates the dobbie mechanism to raise the shafts and the left pedal advances the dobbie bars for the next shed. This feature eliminates the need for a visual search or "feel" for correct treadles, thus increasing accuracy. The leg stretch and octopus treadling on multi-shaft looms is also eliminated.

The automatic warp tensioner on both looms is a joy to use. Once set, the weaver has only to press down on a lever to the right and the warp advances, always under equal tension. On the small loom there is a plastic clamp mechanism which is either pulled up or released to adjust. The 16-shaft loom has the same type of tensioner on the plain beam. On the sectional beam a weight may be shifted back and forth on a lever to adjust tension.

Standard equipment on the 16-shaft AV dobbie includes a front cloth beam wrapped with sandpaper. The warp is tied to a square rod that is connected to a second rod (placed on the cloth beam) by means of extender cords.

When a sufficient amount of fabric has been woven, the rods are cut off and replaced by two $\frac{1}{4}$ " x $\frac{1}{2}$ " (6 x 12 mm) rods woven in, thus eliminating the bulge of the rods and creating a flat, knotless process for rolling on the fabric.

The 12-shaft loom has a groove into which the $\frac{1}{2}$ " square rod fits flush with the beam for the initial warp tying-on process. Then the two $\frac{1}{4}$ " rods are doubled and fitted into the groove to achieve the same flat surface as above. Both looms have the groove in the warp beams at the back so that the loops of the warp may be slipped on and then wound onto the plain beams in the usual warping process.

For weaving over three and one half yards (3.2 m) of fabric, the 16-shaft loom has three metal beams over which the yardage is placed and passed to the back of the loom. It is wound onto the back metal beam under an extremely relaxed tension via a weighted bar mechanism and pulley. About 100 yards (91 m) of fabric may be wound onto this beam.

An accessory to both looms is the "built-in" raddle which slips into two holes at the back of the looms directly behind the plain cloth beams. Both of these beams are equipped with the groove made to accept the wooden rods.

*An accessory for the 16-shaft dobbie is a built-in tensioner for the sectional beam.

The handshuttles available are designed with notched pirns (bobbins) so the yarn does not easily slip off. The procedure of "threading" the shuttle is rather intricate, but if the new yarn is attached to the old before being pulled out, only one threading may be necessary.

A flyshuttle beater is available with the 16-shaft loom. To change the reed, a series of screws must be loosened and tightened again. This procedure is claimed to be necessary in order to keep the reed perfectly aligned so as to allow the flyshuttle to pass freely back and forth.

Both looms have removable "lift-out" beaters to assist in warping. The 16-shaft loom has a built-in bench which may be adjusted to a vertical position to act as a back rest for the warping procedure. The bench made to accompany the 12-shaft loom has a slanting seat which may or may not suit the weaver.

The front cloth beam is removable, as are the metal rod beams of the cloth storage system. The weaver is then able to sit on a footstool and thread the heddles at eye level.

These are excellent looms, well worthy of the serious weaver's consideration.

Eleanor Best

Note from the manufacturer: Ahrens & Violette's 16 harness looms now incorporate a modular system concept. As such, the basic loom can be ordered with as few as 4 harnesses, controlled by treadles rather than a dobbie head. Harness and treadles can be added, at any time, to a total of 12 each. With the loom used in this configuration a unique side tie-up system is used for the treadle-to-harness connection; no under the loom tie-up as on conventional treadle looms.

If more than 12 harnesses are desired, or if the weaver gets tired of using a lot of treadles, a dobbie head can be attached and then the full 16 harness capability of the loom becomes available. This modular system allows anyone, from beginner to full out professional, to buy an Ahrens & Violette Loom at a level which fits their needs and their pocketbook.

YOU HAVE TO BE WARPED TO WEAVE

We Have Warp - Verel* Warp



Weaver's Way[®]

306 E. Goldsboro Street
Crown Point, IN 46307

The Weaver's Way Alternatives in 5/2 (approximately 2,100 yds. per lb.) and 2/2 (approximately 800 yds. per lb.) primarily are sturdy warps suitable for use with both natural and synthetic fibers. Custom spun and dyed for Weaver's Way of 70 percent Verel* and 30 percent viscose, the Alternatives are color fast and subject to minimal shrinkage when machine washed and dried. Available at many handweaving supply shops throughout the country, or send an S.A.S.E. for free sample card.

*Eastman registered trademark.



Issue 6, Oct. 1977 \$2.25 Wool issue: Wool survey, preparation of a fleece. Construction of a Navajo loom. Tapestry. Hints on weaving and finishing rugs.



Issue 7, Jan. 1978 \$2.25 Garments with ethnic flavor; garments from simple patterns. Wool dyeing and mothproofing. Block weaves. Supplementary warps. Tarascan lace. Hopi Embroidery.



Issue 9, July 1978 \$2.75 Fabrics and projects for the interior. Wool finishing. Rugs on Summer and Winter. Bog shirt. Corded weaves.



Issue 10, Oct. 1978 \$2.75 Silk Issue: Availability of silk, silk dyeing, silk garments. Ikat and painted warp. Doup leno.



Issue 11, Jan. 1979 \$2.75 Handwoven garments. Patterns. Fringes. Sprang and frameplaiting. Crackle weave.



Issue 12, April 1979 \$2.75 Coverlet weaves using two ties. Spot weave rugs. Complementary-weft tabby (swivel). Woven miniatures.



Issue 13, July 1979 \$2.75 The business of weaving. Multiple harness crackle. Shaped sculptured rugs. Rag rugs. Corded weaves. Netted hammock.



Issue 14, Oct. 1979 \$2.75 Cotton issue: Fibers, dyeing and weaving. Lace weaves. Combination weaves. Introduction to the multiple harness series.



Issue 15, Jan. 1980 \$2.75 Garments. Blouse, shirt, capes, tunics, etc. Beginning of series on tapestry. Indigo dyeing. Computer generated weave drafts.



Issue 16, April 1980 \$3.50 Rugs, rugs: Many on overshot. Shaft-switching. Silk scouring. Design articles.



Issue 17, Summer 1980 \$3.50 Pine needle baskets. Shaft-switching. Balinese ikat, Hopi embroidery. Silk dyeing. Pick-up. Damask. Corkscrew weave.



Issue 18, Fall 1980 \$3.50 Shawls, throws, foot cozies to keep warm. More tapestry weaves: Including wedge weave. Man-made fiber issue which includes a survey and projects. Multiple harness overshot.

FREE—COMPLETE INDEX OF THE SUBJECTS COVERED FROM JAN. '76 THRU APRIL '80
 NEW—THE WEAVER'S JOURNAL IS NOW IN COLOR.

Order form

Please make checks or money orders in U.S. Funds, payable to **The Colorado Fiber Center, Inc., P.O. Box 2049, Boulder CO. 80306 (U.S.A.)**

Name _____

Address _____

Subscription to *The Weaver's Journal* to begin with issue:

Winter Spring Summer Fall

Free index

Back issues - Please list

Amount enclosed: _____

Subscription Rates

1 Year U.S.A. \$12.00
 Outside U.S.A. \$14.00

2 Year \$22.00
 Outside U.S.A. \$25.00

Back Issues, if available:

July 1976 - January 1978
 \$2.25 for U.S.A. and outside.

April 1978 - January 1980
 \$2.75 for U.S.A. and outside.

April 1980 and later
 \$3.50 for U.S.A. and outside.

THE WEAVER'S MARKET CLASSIFIED

DYEING

YOUR OWN DYE GARDEN . . . over 50 varieties; starter-plants at affordable prices. Many other plants also available. Informative list—\$1.00 FORESTFARM, 990 Tetherwea, Williams, OR 97544

PUBLICATIONS

BOSTON WEAVER'S GUILD PUBLICATIONS Monograph #2 *Weavers' Wisdom* 250 Aids to Happier Weaving. Helpful suggestions for beginners and experienced weavers. \$3.50 ppd. Monograph #3 *Processing and Finishing Handwoven Textiles*. Easily followed directions, essays, bibliography on wet-finishing natural fibers. \$3.50 ppd. BOSTON WEAVER'S GUILD PUBLICATIONS, c/o M. E. Goodband, 361 Norwood St., Sharon, MA 02067

MULTIPLE HARNESS PATTERNS FROM THE EARLY 1700's: THE SNAVELY PATTERNS. 110 drafts, drawdowns, photos. \$7.95 plus 60¢ postage, Pa. residents 48¢ tax. Order from: ISABEL I. ABEL, R.D. 12, Box 282, York, PA 17406.

SUPPLIES

FIBER ARTISTS: Unique supplies available by mail! New catalogue available \$1.00—refundable with FIRST order—write soon! THE WALKING WHEEL, 2498 Stevens Creek Blvd. San Jose, CA 95128, (408) 297-YARN.

NOTEPAPER, SCRIBBLE PADS, GIFT ENCLOSURES, bookplates—featuring textile tools, weaving, spinning, dyeing, sheep. Large selection/top quality. Brochure and samples 35¢. WEAVING AND WOOD, Box 7-WJ, Bayport, MN 55003.

SPINNING & WEAVING supplies: Spindles, wheels, carders, looms, etc. SASE for price list. THE WOOL SHED, P.O. Box 115, Sheep Ranch, CA 95250.

STUDY OPPORTUNITIES

BRITISH ISLES TEXTILE TOUR—Mid May to June 10, 1981. Visit Theo Moorman, weaver: RARE BREEDS SHEEP FARMS—c/o Nora Smids, 10912 S. E. 284th, Kent, WA 98031

SUMMER WORKSHOPS 1981—June 8-12, 15-19, July 13-17, 20-24, August 3-7, 10-14. Beginning, Intermediate, Advanced and Special workshops on the Dobby and Drawloom. Write for brochure. THE WEAVER'S SHOP & YARN CO., 39 Courtland, P. O. Box 457, Rockford, MI 49341.

THIS SUMMER—A VARIETY OF WORKSHOPS: Double harness, jacquard, draw, dobbie, multi-harness, swivel, rugs, wearables; plus basic spinning, dyeing and weaving. SASE for information. THE LOOMS, Shake Rag St., Mineral Point, WI 53565

TRADITIONAL NORWEGIAN WEAVING. One-week summer workshops for beginning to advanced weavers in tapestry and floor loom techniques and spinning. Taught by professionals and weavers experienced in Norwegian weaving. Sponsored by Vesterheim, Norwegian-American Museum, Decorah, Iowa. Access to largest collection of Norwegian textiles in U.S. Call (319) 382-9681 or write: LILA NELSON, Curator of Textiles, Norwegian-American Museum, Decorah, IA 52101

YARNS, FIBERS AND FLEECE

100% COTTON yarns, fibers, spinning tools, books. Samples \$2.00. Long-staple Pima Cotton \$5.00 PPD. COTTON CLOUDS, P. O. Box 651, Fayetteville, AR 72701

NEW IDEAS IN HANDSPUN * All colors * Unusual Textures * \$3/ounce (samples \$3) no synthetics, custom work welcomed—FLEECE & THE UNICORN, Rt 5 Box 368, Stillwater, OK 74074

PRIZE-WINNING FLEECE from major American shows. Pound lots or whole fleeces. White and colored. Most breeds available. Sample book \$2.00. THE WOOL SHED, P.O. Box 115W, Sheep Ranch, CA 95250

ADVERTISERS

INDEX

Ahrens & Violette Loom Co.	3
Anderson Ranch Arts Center	6
Ayottes' Designery	50
Classified Ads	55
Colorado Fiber Center	2
Colorado Fiber Center	54
Contessa Yarns	4
Convergence '82	47
Fletcher Farm Craft School	6
Glimakra Looms 'n Yarns, Inc.	Back Cover
Grandor Yarns	50
Handmade/Fiber Designs	7
Henry's Attic	2
Holroyd, Ruth	5
Ironstone Yarns	5
The Mannings	4
The Mannings	6
New England Weaver's Seminar	2
Ramus, Katherine	45
Serendipity	5
Sievers Looms	6
The Weaver's Shop & Yarn Co.	6
Weaver's Way	53
Wilde Yarns	5
The Wool Shed	5

Most Swedish weavers select a Glimåkra® loom...

COUNTERMARCH ACTION

Mechanically creates a steady shed. Perfect for all warps, fragile to heavy. Up to 12 x 12 harness-pedal combinations. (Loom package includes counterbalance action conversion kit.)

SIMPLIFIED COUNTERMARCH TIE-UP

Braided, linked-loop loomcord and special strong nylon couplers permit rapid KNOTLESS tie-up.

SINCE 1734 BORGS OF LUND

has maintained an outstanding reputation for quality yarns, available in a rainbow of subtle colors, myriad weights and plys.

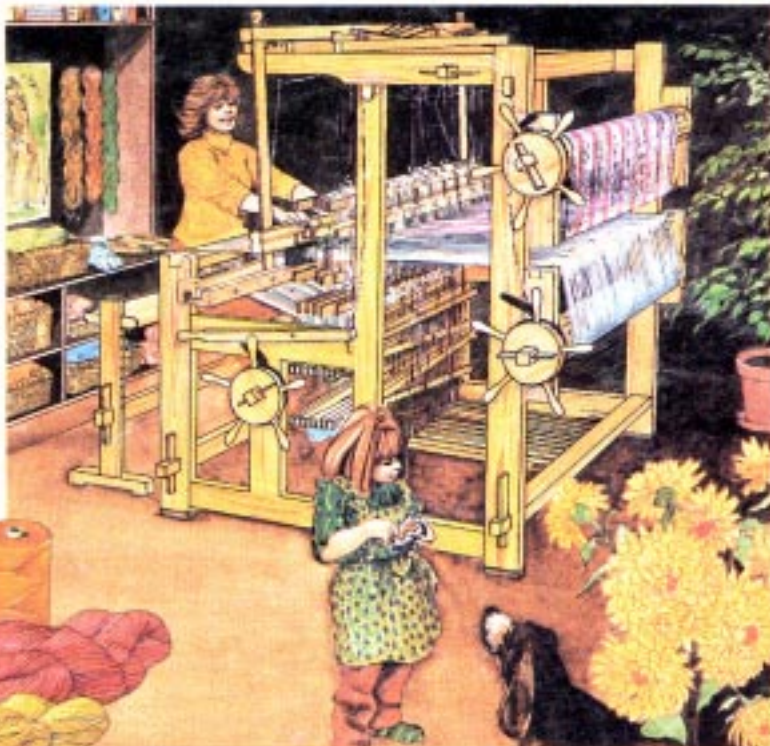

150cm (60") countermarch loom with double-warp beam and fly-shuttle beater

OVERHEAD BEATER

Provides well-balanced, natural beating rhythm. Height and position adjustable. Holds oversize reeds. Laminated to prevent warpage. Massive.

SUPERIOR DESIGN

Open construction facilitates tie-up and dressing. Massive, laminated beams; breast beam lifts out. Strong heddles and tie-up eliminate fraying noise. Wooden wedges, not screws, hold frame tight and make relocating easier.

OUTSIDE RATCHETS

Makes full weaving width available. Easily released by weaver. Weaving sticks facilitate accurate beating.

CONVENIENCE FEATURES

Knee beam for weaving comfort. Adjustable bench (no extra charge). Cloth cover board keeps the work clean. Rubber feet prevent "walking."

...for some very good reasons.

You've probably admired the quality of Swedish weaving. But did you know that in Sweden...and in many other countries...more weavers buy Glimåkra looms than any other brand? Why? Because Glimåkra looms are traditionally designed, with features that have evolved and been developed by skilled weavers over the centuries. That rich heritage of continuing development, enhanced by modern production methods, assures the joy of Glimåkra weaving.

Crafted almost entirely by hand, your steady, sturdy, solid Swedish loom will be a working companion and source of pride for several generations. You can weave everything from fine fabrics to heavy rugs on ALL of our floor looms. And Glimåkra

offers more than a dozen weaving widths (20" to 72"), so you can select the loom that's "just right" for your projects. (For example, you get a full 48" finished project width on our 54" loom.) We also build damask, table, and large tapestry looms (up to 80"), as well as a line of professional, heavy-duty looms, some with weaving widths of over 11 feet! Our full line of accessories includes kits for long-eye heddle, double warp beam, and fly-shuttle attachments. Looms and accessories are stocked in the U.S.

Send for a catalog and yarn samples — you'll be taking the first step toward weaving in the Swedish tradition.

Dealer inquiries invited.

GLIMÅKRA... The Silent Loom, in the Swedish Tradition.™

THE GLIMÅKRA WEAVING CENTER

Rocky River (Cleveland), Ohio

- Over 20 Glimåkra looms (including tapestry and damask models) on display for demonstration and classes.
- On loom and off loom classes, beginning through advanced — some for college credit.
- Specialized classes in damask, tapestry, long-eye heddle and Swedish techniques.



GLIMÅKRA LOOMS 'n YARNS, INC.

P. O. Box 16157 - WJI
19285 Detroit Road (Showroom)
Rocky River, Ohio 44116 • (216) 333-7595

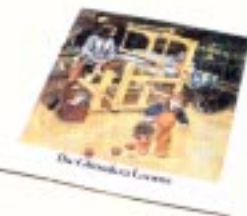

Please rush the Glimåkra looms color catalog (English edition) to me. My check for \$2.00 to cover postage and handling is enclosed.

Send me information regarding Borgs of Lund yarns.

NOTE: Present Glimåkra loom owners —

Send me detailed information on the new, simplified, KNOTLESS tie-up kit.

Name _____

Address _____

City _____

State _____ Zip code _____

Telephone (optional) _____

Tell me more about THE GLIMÅKRA WEAVING CENTER