

# The Weaver's Journal

\$4.00    Volume VII, Number 1, Issue 25    Summer 1982



*In this issue:*

- Jack Lenor Larsen
- Matelasse
- Cardwoven Rug Selvedge
- Upholstery

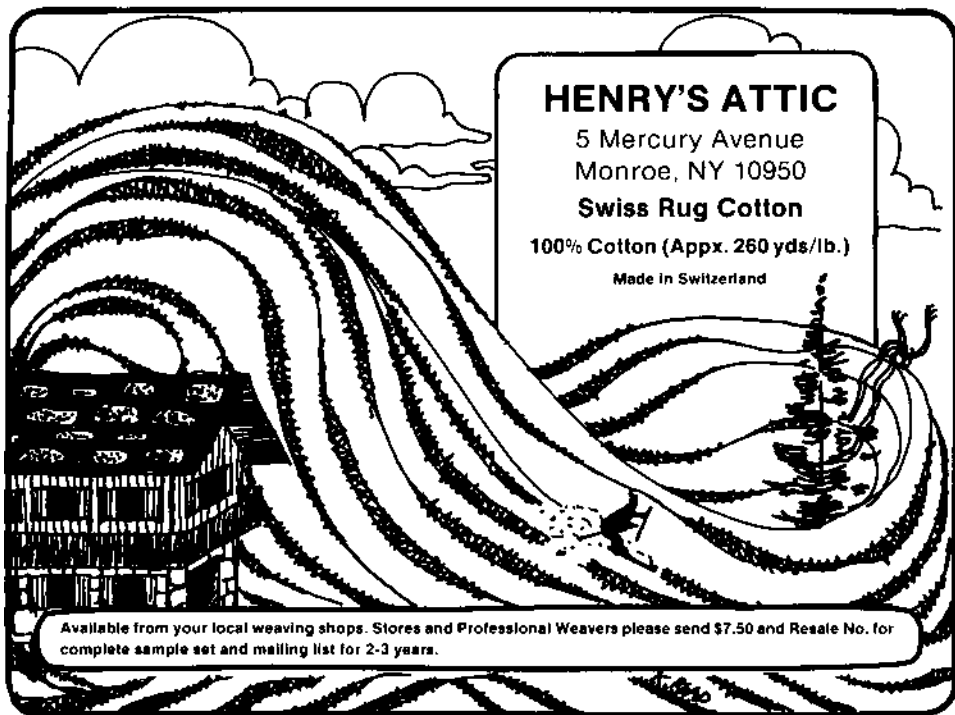







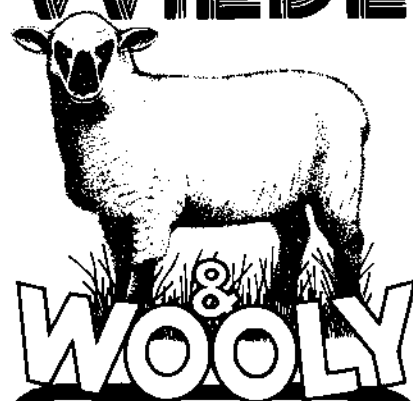

**HENRY'S ATTIC**  
 5 Mercury Avenue  
 Monroe, NY 10950  
**Swiss Rug Cotton**  
 100% Cotton (Appx. 260 yds/lb.)  
 Made in Switzerland

Available from your local weaving shops. Stores and Professional Weavers please send \$7.50 and Resale No. for complete sample set and mailing list for 2-3 years.

# WILDE



-  2, 4 & 6 ply in 8 earthy natural wool colors.
-  natural white wool in various weights and plies.
-  3 & 4 ply wooly Berber yarns in 5 rustic colors
-  sturdy 3 ply wool in 16 subtle shades.
-  fine 2 ply wool for warp or weft in 28 custom dyed colors.
-  the Heavyweight—a bulky wool yarn in 9 bold colors.
-  carded wool in white and natural colors.
-  carded wool in 9 dyed colors.

Send \$3.00 for sample cards.

# WILDE® YARNS

for HANDWEAVING

Custom Spun by  
**John Wilde & Brother, Inc.**  
 3705 Main Street, Dept. W  
 Philadelphia, PA 19127

A Tradition in Spinning Since 1880



### YOU DESERVE THE BEST FROM THE WALKING WHEEL

Handweaving yarn and supplies.  
 Specialized and unique fibers for spinning.  
 Ask about our custom warp chain service.  
 Full-color catalog of yarns, looms and supplies.  
 Visit our store when you are in the San Jose area



For catalog, send \$1.00 to:  
 The Walking Wheel, Dept. F  
 2498 Stevens Creek Blvd.  
 San Jose, CA 95128 (408) 297-YARN

# TREADLED TOGS

BY  
**KERRY EVANS**  
 A PATTERN BOOK OF  
 LOOM-FASHION CLOTHING

A NEW PATTERN BOOK  
 FEATURING  
 22 ORIGINAL DESIGNS  
 SPIRAL BOUND  
 76 PAGES 25 PHOTOS  
 SELF-PUBLISHED  
 \$9.95 + .63 BOOK RATE

PUBLISHER  
 DISTRIBUTOR

KERRY EVANS  
 2308 EAST EUCLID AVE.  
 MILWAUKEE, WI 53207



## IF YOU WEAVE . . .

The Mannings have everything you need!!!

**Instruction** \* Resident instruction in all types of weaving. Special classes for beginners.

**Looms** \* Leclerc - Gallinger

**Rug Yarns** \* Over 300 colors 2-3-4-6 ply. Special skein wool for vegetable dyeing.

**Fine and Fancy Yarns:** cottons - linens - mohairs - wools - novelties - chenilles

**Name Brand Yarns By:** CUM, Lily, Fawcett, Reynolds, Plymouth, Stanley Berroco, Patons

**ORDER TOLL FREE  
DIAL  
1-800-233-7166**

**In Pennsylvania Call**

1-717-624-2223 and receive 1.00 phone allowance on orders over 15.00

Catalog and Rug Wool Samples - .50

**THE MANNINGS  
R. D. 2  
East Berlin, PA 17316**

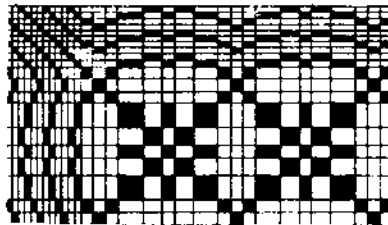

*Two Cape Cod Weavers are now publishing Helen Daniels Young's Chart of Weaves and Monographs. "A Study of the Relationship between Patterns and Borders" is available at 5.95 - .90 shipping and handling. HDY Chart of Weaves is 4.00 - .60 shipping and handling. Be sure to ask about our gift line - tools - upright tapestry loom - books - sett calculator - and more in free brochure and flyers.*

Coming soon  
Summer and  
Winter  
Monograph.

2CCW  
P.O. BOX 186  
BREWSTER\* MA. 02631



**NEW from Restoration Arts** — the "Normandy". Available finished in solid cherry as shown (with minor assembly), or in kit form for a real bargain. Not a reproduction wheel, but designed as a true spinning machine with the character and craftsmanship of a fine antique. Send SASE for brochure and dealer in your area. Dealer inquiries invited.

**RESTORATION ARTS**  
132 South Putman St. Williamston, MI 48895

# Pendleton

## 1982 FABRIC CRAFT SCHOOL

Enjoy a creative vacation in Sedona's spectacular red rock country. Workshops in all phases of handweaving and related subjects. Also woodcarving for beginners.

Instructors: Inga Krook, Kalmar, Sweden; Mary and Fred Pendleton, Sedona, Arizona.

College credit optional. Write for brochure. P.O. Box 233 • Sedona • Arizona 86336 602/282-3671

## THE UNICORN

is having a  
**Special Sale**  
of



**Weaving Books**

	Was	NOW
The Weaving Book by Helene Bress.	50.00	42.50
This monumental best seller sold out its first two printings within months of publication.		
Art Fabric: Main Stream by Jack Lenor Larsen	39.95	33.95
Art of Weaving by Else Regensteiner	18.95	16.25
Beyond Craft: The Art Fabric by Jack Lenor Larsen	37.50	31.95
Color & Weave by Margaret Windeknecht	22.95	19.75
Design for Weaving by Carol Kurtz	16.95	14.95
Handweaver's Pattern Book by Margaret Davison	15.00	12.75
Keep Me Warm One Night by Harold & Dorothy Burnham	40.00	34.00
Key to Weaving by Mary Black	27.95	23.75
Dyer's Art by Jack Lenor Larsen	37.50	31.95
Synthetic Dyes for Natural Fibers by Linda Knutson	16.95	14.49
Woolcraft Book by Jackson & Plowman	24.95	21.49

All of the books listed above are described in our complete annotated catalog of books on **Weaving, Spinning and Dyeing** as well as money-saving **Bargain Books**. You will get a copy **FREE** with your order. If you are not ordering now, you may have a copy **FREE**, but do enclose 2-20¢ stamps for postage.

Stocks are limited. Order early. Sale ends September 1, 1982. We accept **VISA** and **MasterCard**. For faster service, phone 301-881-4770. Sorry, we cannot accept collect calls.



Order from: **The Unicorn, Box 645W, Rockville, MD 20851.**

Add for postage/handling: \$1.75 for the first book and 40¢ for each additional book ordered. (Most of these are big, heavy books.)

This sale may not be combined with any other sales, we offer from time to time.

# Most Swedish weavers select a Glimåkra® loom...

## COUNTERMARCH ACTION

Mechanically creates a steady shed. Perfect for all warps, fragile to heavy. Up to 12 x 12 harness-pedal combinations. (Loom package includes counterbalance action conversion kit.)

## SIMPLIFIED COUNTERMARCH TIE-UP

Braided, linked-loop loomcord and special strong nylon couplers permit rapid, KNOTLESS tie-up.

## SINCE 1734 BORGES OF LUND

has maintained an outstanding reputation for quality yarns, available in a rainbow of subtle colors, myriad weights and plys.

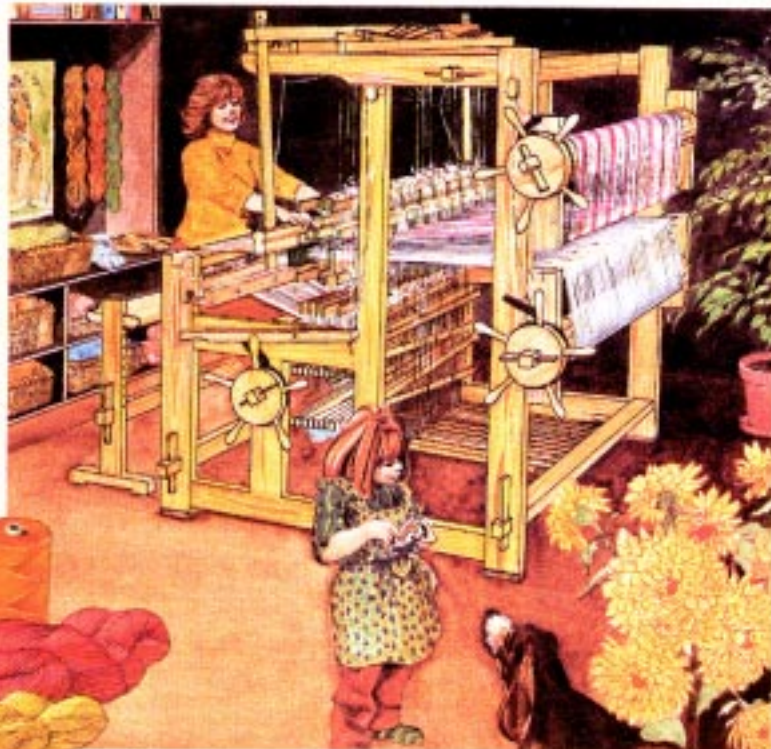

150cm (50") counter-march loom with double-warp beam and fly-shuttle beater.

## OVERHEAD BEATER

Provides well-balanced, natural beating rhythm. Height and position adjustable. Holds oversize reeds. Laminated to prevent warpage. Massive.

## SUPERIOR DESIGN

Open construction facilitates tie-up and dressing. Massive, laminated beams; breast beam lifts out. String heddles and tie-up eliminate fatiguing noise. Wooden wedges, nut screws, hold frame tight and make relocating easier.

## OUTSIDE RATCHETS

Makes full weaving width available. Easily released by weaver. Warping sticks facilitate accurate beaming.

## CONVENIENCE FEATURES

Peace beam for weaving comfort. Adjustable bench (no extra charge). Cloth cover board keeps the work clean. Rubber feet prevent "walking."

## ...for some very good reasons.

You've probably admired the quality of Swedish weaving. But did you know that in Sweden... and in many other countries... more weavers buy Glimåkra looms than any other brand? Why? Because Glimåkra looms are traditionally designed, with features that have evolved and been developed by skilled weavers over the centuries. That rich heritage of continuing development, enhanced by modern production methods, assures the joy of Glimåkra weaving.

Crafted almost entirely by hand, your steady, sturdy, solid Swedish loom will be a working companion and source of pride for several generations. You can weave everything from fine fabrics to heavy rugs on ALL of our floor looms. And Glimåkra

offers more than a dozen weaving widths (20" to 72"), so you can select the loom that's "just right" for your projects. (For example, you get a full 48" finished project width on our 54" loom.) We also build damask, table, and large tapestry looms (up to 80"), as well as a line of professional, heavy-duty looms, some with weaving widths of over 11 feet! Our full line of accessories includes kits for long-eye heddle, double warp beam, and fly-shuttle attachments. Looms and accessories are stocked in the U.S.

Send for a catalog and yarn samples — you'll be taking the first step toward weaving in the Swedish tradition.

Dealer inquiries invited.

## GLIMÅKRA... The Silent Loom, in the Swedish Tradition.™

### THE GLIMÅKRA WEAVING CENTER

Rocky River (Cleveland), Ohio

- Over 30 Glimåkra looms (including tapestry and damask models) on display for demonstration and classes.
- On-loom and off-loom classes, beginning through advanced — some for college credit.
- Specialized classes in damask, tapestry, long-eye heddle and Swedish techniques.



## GLIMÅKRA LOOMS 'n YARNS, INC.

P. O. Box 16157 - WJ1  
19285 Detroit Road (Showroom)  
Rocky River, Ohio 44116 • (216) 333-7595



Please rush the Glimåkra looms color catalog (English edition) to me. My check for \$2.00 to cover postage and handling is enclosed.

Send me information regarding Borges of Lund yarns.

**NOTE: Present Glimåkra loom owners —**

Send me detailed information on the new, simplified, KNOTLESS tie-up kit.

Name \_\_\_\_\_

Address \_\_\_\_\_

City \_\_\_\_\_

State \_\_\_\_\_ Zip code \_\_\_\_\_

Telephone (optional) \_\_\_\_\_

Tell me more about THE GLIMÅKRA WEAVING CENTER

# The Weaver's Journal

Quarterly Journal for Textile Craftspeople

\$4.00    Volume VII, Number 1, Issue 25    Summer 1982    ISSN #0160-3817

## ARTICLES

- 10 **An Interview with Jack Lenor Larsen**  
18 **Trends For Fashionable Interiors**  
by Susan Hick  
20 **Interface: A Wire Weaving**  
by Donna Sullivan  
22 **Upholstery**  
by Maxine Wendler  
24 **Desk Chair with Subtle Plaid Pattern**  
by Joyce Lohse  
26 **Looming Thoughts**  
by Allen Fannin  
28 **Woven Felted Boots**  
29 **4-Shaft Twill Neck Scarf**  
by Elizabeth Kolling-Summers  
30 **Weaving A City Skyline**  
by Ann K. Wennerstrom  
32 **Different BUT Related**  
by Dorothy N. Smith  
34 **Double Woven Mailbag with Name Tags**  
by Lieve Verlinden  
37 **Stitched Double Cloth—Matelasse**  
38 **Stitched Double Cloth Vest**  
39 **Loom Controlled Quilted Fabrics**  
by Kathryn Bardwell  
40 **Simple Matelasse by the Pick-Up Method**  
41 **Reversible Matelasse Jacket**  
by Ellen Champion  
43 **Matelasse Double Cloth Stitched to Form  
the Design**  
by Linda Kelly  
45 **Weave Analysis**  
by Joyce Marquess Carey  
48 **A Cardwoven Selvedge for Weft-Faced Rugs**  
by Martha Stanley  
53 **Linbogarn Shirt**  
by Jean Scorgie  
56 **A Braided Strap from Colombia**  
by Adele Cahlander  
60 **Backstrap Weaving for Penance and Profit**  
by Charlotte Coffman  
71 **Song of the Sky Loom (A Poem)**

## DEPARTMENTS

- 4 **Letter from the Editor**  
6 **Mail Bag**  
9 **Good Ideas from our Readers**  
63 **Book Reviews**  
68 **Product Reviews**  
69 **Product News**  
70 **Coming Events**  
72 **The Weavers' Market—Classified**  
ibc **Advertisers Index**  
A **Index, Volume VI**  
B **Errata, Volume VI**

*Cover Photo: "Fantasy." Jacquard woven wool Wilton carpet. A Larsen design. See also "An Interview with Jack Lenor Larsen," page 10.*

**Editor and Publisher:** Clotilde Barrett  
**Associate Editor:** Mary Derr  
**Advertising:** Margaret Martin  
**Circulation:** Maxine Wendler  
**Photography:** Earl Barrett & Jan Carter  
**Production:** Ellen Champion  
**Staff Artist:** Kay Read  
**Typeset** by WESType Publishing Services, Inc.  
**Printed** by Mountain West Printing and  
Publishing, Ltd.  
**Color Separation** by Spectrum, Inc.

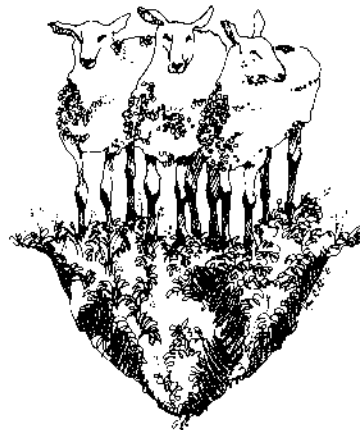

The Weaver's Journal is published on the first of each January, April, July and October by the Colorado Fiber Center, Inc., P.O. Box 2049, Boulder, Colorado 80506. Telephone (303) 449-1170, 444-2088. Subscription rates are \$15.00 U.S. Currency for 1 year (4 issues) or \$29.00 U.S. Currency for 2 years (8 issues). Colorado residents add 3% sales tax. Outside U.S.A. - 1 year - \$18.00 U.S. Currency, 2 years - \$34.00 U.S. Currency. Copyright Colorado Fiber Center, Inc., 1982. Second-class postage paid at Boulder, Colorado and additional mailing offices. The Weaver's Journal USPS 584-210. The editorial committee takes no responsibility for the goods advertised in this journal. POSTMASTER: Send address change form 3579 to The Weaver's Journal, P.O. Box 2049, Boulder, CO 80506.

## Weave a greeting card!

Send personal, one-of-a-kind note cards—for that extra special touch.

Design your own greeting cards with an original weaving . . . your handwoven remnants . . . a handmade lace . . . any fibre art creation will do!

Then, mount them in these delicately textured oval frames and glue to the matching note cards for a truly special way to say "Thank You," "Happy Birthday," or just "Hello!"

Includes:

- 10 note cards—5 white and 5 ecru
- 10 matching oval mats
- 10 matching envelopes
- 10 patterns—8 weaving and 2 tatting ones

All for just

**\$9.95**

postpaid.

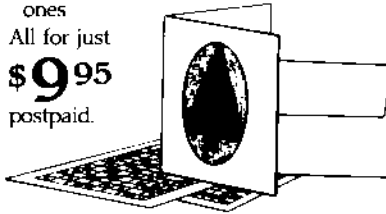

(Illinois residents please add 6% sales tax.) Offer expires 9/30/82.

### Serendipity Shop

1523 Ellinwood  
Des Plaines, Illinois 60016

Send 50¢ for our lace catalog.

Send \$1 for our complete fibre arts catalog.

### Freight Free up to \$50

on looms from

• GLIMAKRA • NORWOOD •  
LECLERC • HERALD • BEKA

also

PIPYCRAFT, LECLERC  
& ASHFORD  
SPINNING WHEELS

Complete book of  
catalogs available, \$5  
(deductible from first purchase  
of \$50.00 or more)

"INSTITUTIONAL INQUIRIES WELCOME"

## THE GOLDEN HEDDLE

1602 Rochester Rd.  
P.O. Box 761-WJ  
Royal Oak, MI 48068  
(313) 547-9159



### SILK CITY FIBERS

155 Oxford St. Dept. WJ  
Paterson, NJ 07522  
201-942-1100

For purists not a trace of synthetic

### MOHAIR/WOOL YARN

unscoured, available in two sizes  
natural color



**LONE STAR:** A lustrous brushed yarn available in two sizes. 980 yds./lb., 2,100 yds./lb.

**RUFFLES:** A wonderful loopy, lace yarn. Available in two sizes. 980 yds./lb., 2,100 yds./lb.

**Description:** 100% adult mohair from the angora goat raised in Texas. Core and binder domestic pure new wool from sheep also raised in Texas. Yarn is spun in New England. Put-up on 3/4 lb. open dye skeins. Price: \$14.25/skein.

Stores and professional weavers please send \$10.00 for a full year of quarterly mailings of other luxurious nature fibers and mill end closeouts. • Volume Discounts • School Pack Assortments •

Minimum Order: \$100.00

After 11 years of mountain living northwest of Boulder, my husband and I decided to move our penates to an apartment in the city. For a weaver, establishing a new home and facing the problems of decorating a new interior, is an exciting time. Fabric is the key element in creating an environment which must be practical and also give sensual and visual pleasure. Small projects, such as throw pillows are relatively easy to accomplish. However, weaving for the interior often involves large projects such as draperies, curtains, upholstery and bedspreads which require a big commitment of time and money. A bad judgment can lead to a big disappointment. In order to insure success with the first trial the weaver has to choose the right colors, the right fibers and a weave structure which is perfectly suited for the intended use. There is so much at stake! If we could only turn to someone for advice, listen to an expert who has devoted an entire career to fabrics for interiors, who could help us look at interiors the way a professional designer would do? Of course, Jack Lenor Larsen, a weaver, designer, teacher from New York who has received worldwide recognition for his talents in creating beautiful interiors. The questions I asked him relate directly to me, as a weaver, wanting to be successful with planning fabrics for my environment. I am sure that the same questions have been raised by many weavers before.

Jack Lenor Larsen has generously accepted the questions and in this issue of *The Weaver's Journal* our readers will share his answers to basic design problems and also share the philosophy and attitudes of a great thinker.

Designing for interiors was foremost on my mind when I assembled the content of this issue. However, I also wanted to fulfill my promise to the beginner weaver and incorporate a few projects that are truly fun and easy. For the readers who value *The Weaver's Journal* as a teaching companion there is, in this issue, the first complete explanation of cardwoven selvages for rugs and an essay on stitched double cloth suitable for 4 and more shafts.

*Clotilde*

JUST OFF THE PRESS

# BOUNDWEAVE

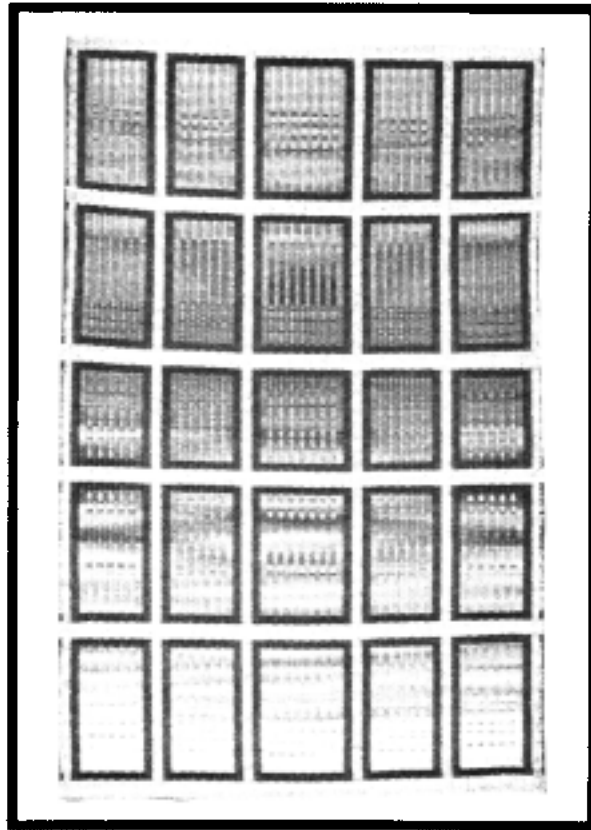

CLOTILDE BARRETT

Boundweave is an easy, basic weave with tremendous design potential. Never before has this technique been studied in such depth.

Profusely illustrated with B/W photos, color photos, line drawings and work sheets.

8½ x 11, 92 pp., Paperback ..... \$9.95

U.S.A. (Add \$1.50 postage and handling)

Outside U.S.A. (Add \$2.00 postage and handling)

## ORDER NOW FROM

COLORADO FIBER CENTER, INC.

P.O. Box 2049

Boulder, CO 80306

Dealer inquiries invited

# MAIL BAG

There is no way to praise your publication enough. Now it's a visual pleasure too! Color—yea, yea. Well worth the money.

You are teacher, inspiration, reference work, my "Weaver's Bible". When I first became interested in weaving, I said to myself: "Ugh. I'm not going to learn all those squares and paper work. Samples? No way! I'll just dash off what I feel." It's called You Made Me Do It, and it's such a good on-going experience.

Thank you for being. Thanks for all your hard work. Y'all make me think!

Gail Newman  
Avon, CO

Rag rug table mats may be new to Canada but not to Sussex County, New Jersey. That was practically my first weaving, over 25 years ago. There are hundreds of them scattered all over, and they are still a good seller at our church bazaars. At one time I got 10-yard pkgs. of patchwork cotton from Montgomery Ward at 23¢ a yard. It

is now over \$2.00 a yard and not practical.

A better finish is machine stitching twice and then overcasting to cover the machine stitching, cutting apart after finishing.

Louise Lewis  
Branchville, N.J.

Hope you will consider a series of articles in *Weavers Journal* explaining with examples, some of the terminology (treadle as drawn in, weaving on opposites, rose fashion, star fashion, etc.) which are so taken for granted by experienced weavers that they never define them in their books or articles.

Helen Gaynor  
Oak Park, IL

*Ed.: We are planning a section on basic weaving instructions and projects for beginners. Watch for these in the October issue!*

I only wish I had discovered your wonderful magazine earlier!

Linda L. Howson  
Hammond, IN

Received my first issue of *Weaver's Journal* today. I haven't been weaving very long but I certainly like *Weaver's Journal*. Wish I had been receiving it before.

Dorothy E. Evans  
Troy, N.Y.

I think the idea of a Mail Bag section is a good one. I am sure that I shall gain from other weavers' questions or ideas.

Marian Campbell  
Milwaukee, WI

It would be a great service to your readers if you listed ERRATUM in the index of each issue of *Weaver's Journal* for obvious reasons.

It's a real pain to locate ERRATUM—and far worse, to warp and weave before these corrections appear.

Ellen K. Engle  
Rogers, AR

*Ed.: Thank you for your suggestions. We will list the erratum from now on in the table of contents so that it will be easy to spot.*

I enjoyed the article in your winter issue on Barbara Knollenberg. The photos were excellent and her work is exquisite. I hope you follow her work. I'd love to see more of it.

Tigerlily Jones  
Mendocino, CA

Two years before my enforced retirement as a first grade teacher in an Indiana school, our superintendent decreed that all teachers must take some form of refresher course or take a salary cut. My two housemates and I had always spent our summers in Vermont. Several years before we had acquired our life's dream, a small summer cottage in the Green Mountains. When I was so near the end of my teaching career, giving up a summer in Vermont for scholastic work was unthinkable. After much consideration, Vermont won out. We packed our bags and away we went to our little cottage, salary cut or not.

**J & D**  
**Highland Imports**

presents

*Fine Woolen Weaving Yarn  
from Scotland*

*Perfect for Tartans and Tweeds*

Send \$2.00 for sample cards (refunded with first order).  
P.O. Box 5497 • Richmond, California 94805

**Full color range of Berga yarns**  
*"Swedish wool spinners since 1856"*

Wool, alpaca, cotton, linen blends  
Ten sample cards: \$10  
22 to 130 colors/card

MAIL ORDER

**Caryl Gertenrich**  
459 High S.E.  
Salem, Oregon 97301  
(503) 363-9665



*Handweaving With Robert and Roberta*

**A TRULY EXCELLENT HOME STUDY PROGRAM**

STARTING WITH VOLUME ONE, THE FOUNDATION SERIES OF ASSIGNMENTS INCLUDING EQUIPMENT, DESIGNING, FIBER, COLOR, DRAFTING & BUSINESS **PLUS** ESPECIALLY PLANNED **WEAVING PROJECTS** TO BUILD YOUR FUNDAMENTAL WEAVING KNOWLEDGE AND SKILLS.

VOLUME TWO, THREE & FOUR CONTINUE STEP BY STEP TO HELP YOU PROGRESS FAR BEYOND THE MANY WEAVERS WHO HAVE FLOUNDERED YEAR AFTER YEAR.

WRITE FOR FREE DETAILS INCLUDING AN INDEX TO

**AYOTTES' DESIGNERY, DEPT. WJ, CENTER SANDWICH, N.H. 03227**





After we had settled in, I picked up a Vermont Life magazine and saw this ad, "Fletcher Farms Is Opening." The crafts were listed and among them one in which I had long been interested but could not do anything about in our Indiana situation: WEAVING. Here was a golden opportunity,—summer in Vermont and a weaving course. Fletcher Farms was only 25 miles from our little place and I could spend the weekends with my friends.

Fletcher Farms was just what it said, a farm with large old buildings converted into classrooms and workshops, dormitories, dining hall, etc. When I reached the farm and was duly admitted and registered, I was taken to a huge old barn up the hill from the other buildings. When I stepped through the door and saw all the lovely looms, the bright colored threads, the weavers working diligently, and heard the click-click of the shuttles, I was hooked.

I was greeted by the teacher, a plump little lady with her gray hair

piled high on her head and the merriest twinkle in her eyes. This was Berta Frey, a celebrated author and weaver of that time (50's). She looked straight at me and said, "So you want to be a weaver. Well, let's get to it."

She sat me down at a four harness loom already warped, told me the bare essentials, handed me a shuttle and said, "Press your foot and shoot the shuttle. Now you are on your own." She came by later and said, "My dear, you have rhythm if nothing else. Keep it up."

That experience at Fletcher Farms is one of my most precious memories. Every morning we trudged up the hill after a hearty Vermont breakfast, worked at our projects and trudged down the hill for lunch, returning to work in the afternoon. Promptly at four o'clock, Miss Frey would say, "All right, girls, time to stop. Cease your shuttling." Each day we learned something new and if one lives to be a hundred, one will never know it all.

To vary the program, one night a week we would go to Weston, some 20 miles away, to a church supper. If you have never tasted a Vermont church supper, you have yet to experience a culinary delight. Our cook got a vacation, too. We were invited to another weaver's home, a dairy farm, and such ice cream! Once we visited a weaver who had converted an old red school house into a charming weaver's cottage. Our group was just the right size to be interesting and soon we were on a first name basis.

Our dormitory was a large old house originally belonging to the Fletchers, the family of a former Vermont governor (who, I was told, met the Crafts Society half way with expenses and the use of the property). What did we care if six had to share the same bathroom, the wind blew in the window cracks, and the rafters creaked. It was such fun!

All this in the shadow of dear Berta Frey. How I wish she could know what an influence she had

on my life. But, alas, she has long since gone to her reward. I saw her once later at a New England Seminar but since she was celebrity and the speaker, I could do no more than shake her hand. I hope she knows that through the years I did get some blue ribbons and a silver dish for the best in show,—all the result of her guidance.

Fletcher Farms is still operating but I understand it is now quite modern. The old weaving barn was destroyed by fire. The dormitories are now motel-like rooms with private baths, no less, and the sweet little dining room has gone cafeteria. The flavor has been lost.

Ruth M. Kinne  
St. Petersburg, FL

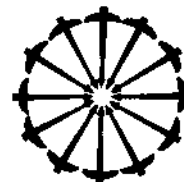

## MACOMBER LOOMS

THE KEY TO YOUR  
WEAVING DESIGNS

**D**ESIGNER'S  
DELIGHT®

THE DOBBY WITH A  
DIFFERENCE

Beech Ridge Road  
York, ME 03909  
207-363-2808

## MACOMBER LOOMS

A microcomputer that controls the harness tie up and treadling sequence of your pattern. You can add it on to your standard Macomber loom in less than one hour with simple tools, or order as an accessory on your new Macomber loom giving you two looms for the price of one conventional dobby loom.

Conventional dobby looms lock the weaver into a preprogrammed pattern without allowing for correction or modification of the pattern during weaving.

The DESIGNER'S DELIGHT overcomes this limitation with three selection modes.

*Design Mode*-design, change, correct, and record the pattern as you weave it.

*Automatic Mode*-preprogram your pattern, step on the pedal, throw the shuttle and weave.

*Manual Mode*-when you just want to play or experiment and not record your pattern.

In addition your pattern may be displayed at any time on the L.E.O. display. The DESIGNER'S DELIGHT features single pedal operation, permanent storage of your tie up, and permanent storage of your treadling sequence on separate keys for future use. For example you may use the same tie up key but different treadling keys for many patterns.

This unique yet simple device allows us to offer up to 32 harnesses capacity in 24" 72" weaving widths with single pedal operation.

Get the best! Buy a MACOMBER LOOM.  
Ask the weaver who owns one.

For further information call or write

MACOMBER LOOMS Beech Ridge Road York, ME 03909 207-363-2808

**A  
Classic  
in  
Cotton**

The weave: Tabby  
The sett: 8 e.p.i.  
Warp & Weft: Weaver's Lace,  
100% cotton from  
Weaver's Way



**Weaver's Way**

306 E. Goldsboro St.  
Crown Point, Indiana 46307

Please send 60¢ in postage for sample cards and catalog

HARRISVILLE, N. H.

*Two centuries of craftsmanship*



**HD**

We are makers of:

Dyed Yarns

Natural Yarns

Hand Loom Kits

Weaving Accessories

Complete Sample Catalog \$4.00

HARRISVILLE DESIGNS

Harrisville, N.H. 03450



*"a happy marriage —"*

That's how a student-customer described her experience here at Sievers.

Excellent, high quality Sievers looms and spinning wheels and the most rewarding instruction you could imagine—a 'marriage' if you will. This summer there will be over thirty courses taught by twenty two qualified teachers.

If you want the best in proven equipment or if you need pleasant, warm guidance, then be sure to write for all the information—it's free.

**SIEVERS LOOMS, SPINNING WHEELS and SCHOOL OF FIBER ARTS**

**Walnut St. Washington Island, WI 54246**

Happiness is in Your Hands—and it Keeps You Young!

**FROM THE LAND  
WORLD-FAMOUS FOR  
BEAUTIFUL WOOL...**



We're proud of the range, quality and packaging of our fine New Zealand wools.

Our colour catalogue presents samples of top quality pure bred New Zealand wools, both in fleece and carded form, ready for spinning. For weavers, we have natural coloured yarns.

Our comprehensive catalogue shows it all. It will be yours by return airmail when you send \$2.00 (refundable) to:

New Zealand wools leave each farmers' shearing shed in bales up to 350lb each. We have captured the essence of the New Zealand wool scene with a replica bale—our compact, convenient "MINI BALE" of up to 4lb.

Peter & Margaret Black,  
Golden Fleece (1981) Ltd & Co.  
P.O. Box 40(H) Man kau,  
Levin, New Zealand.

**Golden  
Fleece**  
NEW ZEALAND

Group and trade enquiries welcome

## \*\*\* good ideas from our readers

### TRADITIONAL GOES MODERN

A friend showed me a very old coverlet, a Summer-and-Winter weave, handsome in very dark blue and what is now, with age, a cream color. It was wool, good protection against cold weather and so heavy it would weigh down the puffiness of a feather bed and make it look smooth and neat.

I thought it would be fun to use such old patterns but weave a light modern coverlet. I chose an overshot weave. Among the large overshot patterns in Marguerite Porter Davison's *A Handweaver's Pattern Book*, my eye was caught by

Johann Speck's Design No. 33; such a delightful name and the pattern a happy combination of curves and rectangles. I started adapting the materials according to my plan.

A lighter, brighter blue seemed right for the pattern weft and I selected the fiber yarn Verel. The Verel threads blended well; the completed coverlet draped softly. For the tabby weft and for the warp I used mercerized cotton, natural color, 16/2. With a 15-dent reed I had 30 ends per inch (120/10 cm).

There was no problem using the traditional coverlet pattern with the present-day fiber yarn—the Verel seemed quite happy, and with the pleasing finished product so was I!

*Katherine B. Lee*

photo by Grace Ultrich



## Champion of the Shuttle Race



### Schacht Boat Shuttles

We make a variety of fine hardwood shuttles.

The Schacht line of boat shuttles are beautifully shaped and balanced; see worthy. In dock at your dealer.

Let us introduce you to our complete line of handweaving looms and accessory tools.

Write to us for our free catalog and the name of your local dealer.



SCHACHT SPINDLE<sup>CO</sup> INC.  
P.O. Box 2157 Boulder, CO 80306

# AN INTERVIEW WITH JACK LENOR LARSEN

Photo 1. "Laotian Ikat." A Larsen design

Jack Lenor Larsen is a noted weaver, craftsman and designer. He is also founder and president of Jack Lenor Larsen incorporated, a New York based international company. Some of the fabrics he has designed hang in museums in the United States and Europe as examples of his talent. Many important buildings glow because of his designs.

His unique style has been attributed to his sensitivity to the world's culture, his wide travels and his appreciation of the skills and talents of ethnic groups. He uses materials ranging from natural to plastic. He often turns to handspinning or hand weaving, but employs high technology methods too. His work is eclectic, combining different traditional weaving ideas to produce new and exciting fabrics suited to modern needs.

Recently Larsen was honored with a retrospective show at the Musée des Arts Décoratifs in Paris. His show, "Thirty Years of Creative Textiles" was exhibited from September 28, 1981 to December 28, 1981. An 84-page catalog of the show, abundantly illustrated with color and black-and-white photos is available for \$12 from Catalogs, Public Relations Dept., Jack Lenor Larsen inc., 41 East 11th St., New York, NY 10003. This same exhibition is being mounted at the Musée des Arts Décoratifs in Montreal opening June 10 and will remain there through the summer. The exhibition will then be remounted, titled in English and travel in the United States.

Jack Lenor Larsen has many publications to his credit. *The Art Fabric: Mainstream* is his most recent book and is coauthored with Mildred Constantine. A correlated exhibition is traveling for the next two years in the United States. He is presently writing a book called *Interlace: On Plaiting and Related Techniques*. It will show the relationships between all interlacing, in braids, baskets and mats, and in weaving.

Among his publications in a book written with Jeanne Weeks, *Fabric for Interiors: A Guide for Architects, Designers and Consumers*. It is of particular interest to the handweaver who weaves upholstery fabric, rugs, case-ment cloth and other fabrics for homes and public places.

Because Jack Lenor Larsen is always generous in sharing his innovative ideas on textiles with others, *The Weaver's Journal* has asked him the following questions which we print with his answers. We hope you will find them interesting and stimulating.

**1. Handweavers are often accused of a "narrow-minded" approach to designing projects. Are there ways they can expand their minds and stimulate their creativity?**

I would say that handweavers are often accused of approaching projects with a narrow mind or of having a narrow minded approach to projects.

I feel that research is the antidote to narrow-mindedness. Most of our designs start with a material that we like, or with a technique that we want to use. Sometimes, in our work for air-

lines, we have to consider function as the primary limitation. I like to work with as many limitations as possible, and I use these as a corral to define the design approach. I often start with a material and make a warp of it on a simple four or eight shaft draw, then explore the possibilities of how to keep the beauty of the yarn. Will a very fine yarn retain its character or will bringing warp floats to the surface show it off to advantage? To create the character of cloth that we are working towards, how practical must I be with a tight weave and tie-downs?

I like to make lots of samples and then pin them up so as to compare them, evaluating which are more successful. Sometimes I will take these off the loom and go through this process for a day or two, and then resume weaving.

Too many handweavers are generalists. Trying one course after another, they are jacks of all weaves, masters of none. I feel that specialization is as important for the avocational weaver or the new one, as it is to professionals. I suggest that after a certain point, craftsmen should specialize in some aspect or another, say in one material, format, or technique, or one combination of colors. When Lenore Tawney said she was bored with her beautiful poetic tapestries in which she had used a thousand yarns in many textures and colors, I suggested that she consider using only one yarn in only black and white. And, when she did so, she grew very quickly with strong forms and deeper expressions developing. I had learned this from a student of mine

who was both a mother and fully employed. With only a limited time for weaving, she worked in simple double cloths of black and white linen. She soon became so expert in this as to have probed deeper than anyone else.

**2. If a person has an emotional attachment to an era, a place or a culture, how can he incorporate such nostalgia in his interior design work?**

**How can one recapture the aura of a bygone era in a contemporary statement?**

**In designing a colonial coverlet, for example, how can one give it a contemporary look and still keep the colonial mood?**

I think I have learned most from asking myself such questions as "why do I like it? What is there about a pattern or a color play that causes me to focus on it?" This questioning sometimes leads to learning a generalization, such as, close valued colors fuse more easily, or black warps tend to show off weave patterns better than white ones.

I believe that it is most useful to study the techniques of distant cultures. These are the most abstract, the least likely to permit imitation. I believe that in going so far afield, one comes back with a more personal statement. In learning from the ancient Peruvians, for instance, one cannot duplicate because our yarns and looms are different; so is our sense of time. "Borrowing" from contemporary designs is, on the other hand, mere imitation.

Speaking of ancient Peruvians reminds me that most new weavers are too casual about edge finishes, with a tendency toward stringy fringes and un-beautiful resolutions to borders. I ask them to look at ancient cloths to realize that if those weavers were short on time, they would concentrate on the border only with the center field in a simple plain weave. The way that we braid or stitch or otherwise resolve the beginnings and endings can be an important aspect of the design.

Regarding Colonial coverlets, I find many of them are extremely beautiful, well resolved in terms of pattern, color, and durability. Attempting to reproduce one would find ways to personalize the second one. Most recent versions do not have the integrity of the original because the yarns aren't as characterful or appropriate. Typical

coverlets in overshot, for instance, had a Germantown or Saxony yarn sufficiently twisted to permit a long surface float. Not every yarn can be used so well, and the relationship between the cotton ground warp and the wools must be considered. Or is there another possibility? Today, a wool ground is applicable and silks are available for the float yarn. If Colonial coverlets almost always contrast a natural cotton with indigo dyed wool, today's version might have values which are very close.

I believe one of the key differences between the amateur and the professional is not how much the professional sells, but the constancy with which a professional develops personal style, then continues with it, evolving toward skill and true perception of the character of the design he is working. Knowing how finished work behaves in time and place, he at last becomes an expert and a master.

**3. You have said, "Design is not a pattern on cloth; design is the cloth in all its aspects, including pattern." Should one design furnishings to fill the needs of society or should one seek for an aesthetic that goes beyond the practical needs?**

Of course, both are essential. For handweaving today the aesthetic must be emphasized. No one can afford vast quantities of American handwoven fabric unless the aesthetic properties of that fabric are vastly superior to stock goods. The aesthetic properties need not be in the amount of color and pattern, but could, as easily, be in the quality and integrity in the fabric itself. When we were asked to replace the original fabrics for Frank Lloyd Wright's famous Fallingwater, we used handspun wools primarily in their natural colors. The structure of the interlacing and the twisting of ungraded fibers became the design.

**4. How does one become sensitive to the emotional needs of people who live a lifestyle dictated by technology and the economics of an industrialized world?**

Consider the psychic needs of people too often living indoors in cities. We have given up so very much, losing the textures, the shadow patterns, and nuances of color which exist in nature outdoors. Indoors, in cities, we miss the changing of seasons and the

microclimates from morning till noon to sunset. We are too often closeted in shoebox interiors which have no sense of materials, no great architectural detailing, no sense of connection of how the materials were put together. Even a 19th century farmhouse had these properties. They also had an individual setting so that the environment was the whole farm or village. We have come a long way in some respects, but have given up so much!

Further, I feel that fabrics, better than anything manmade, can substitute and console for outdoor textures. The random striae and organic rhythms, the broken color possible in fabrics for walls and carpets and furniture, the hand of fabric provides practice for our fingers and for our eyes.

**5. What is the main function of design when it is applied to furnishings? What should a designer focus on first? Are there important design elements in addition to color, texture and patterns?**

I feel the starting place is an honest statement and a humble one. Sometimes that is as far as it needs to go. I am most upset with work that is pretentious, which presumes. A great actress can afford to throw away her lines. So can a master craftsman. Aggressiveness is out, particularly in the spaces we work and live in. Understatement is in. Anonymity is a pleasure which I didn't always have.

The current notion that all craftsmen are artists is fallacious—no culture has produced many artists. I am more content working on simple upholstery or carpet, than in competing in the increasingly commercial art market. I recommend that weavers realize that simpler things, perfect beauty, the basket or mat done well enough, becomes an art form not competitive with painting. New York's Museum of Modern Art recently bought for \$12,000.00 a Moulthrop turned wooden bowl without function or image.

Other design considerations are surely the sensitive ones of integrity, harmony, and unity. I feel that when one decides whether something is right, feels wrong, or must be discarded, the main reason is often a question of dominance. Often, color and pattern, or yarn and woven texture, are in

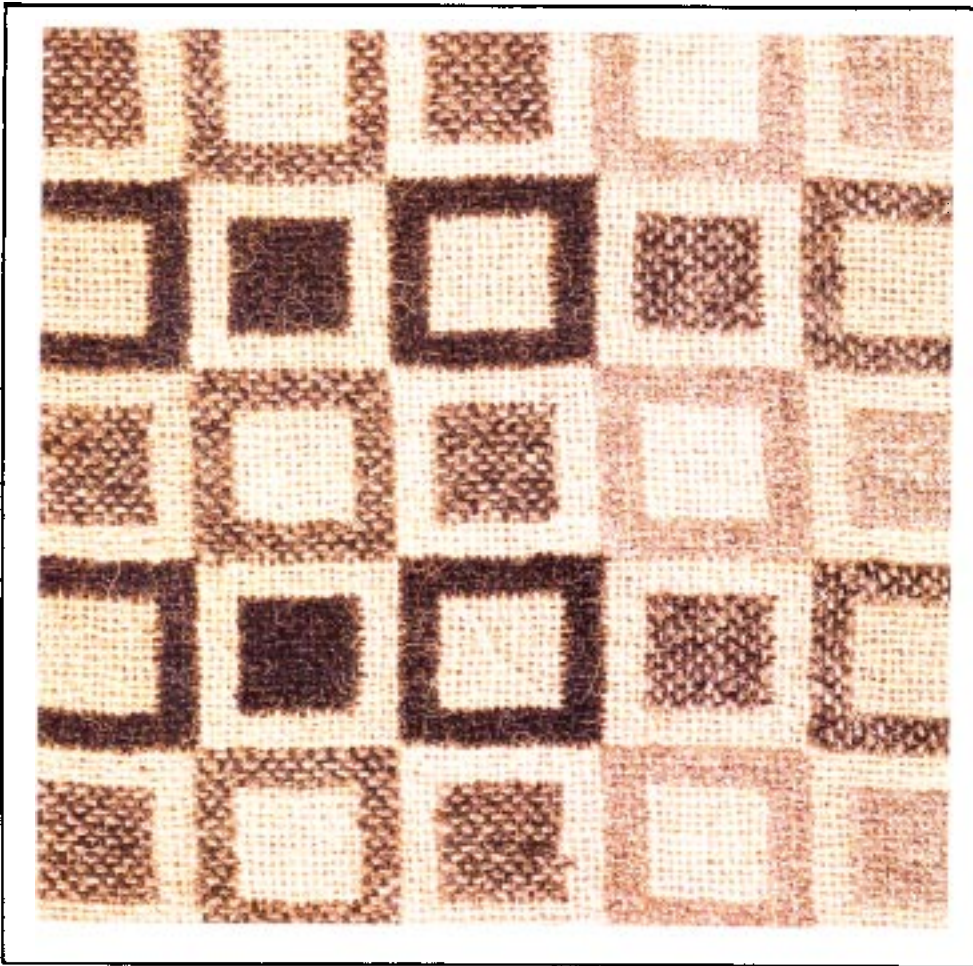

*Photo 2. "Matrix." 100% worsted wool  
Jacquard weave. Woven in Ireland. A Larsen  
design.*

*Photo 3, below. "Horsetail." 62% cotton,  
26% viscose and 42% polamide. Woven in  
France. Larsen Design Studio.*

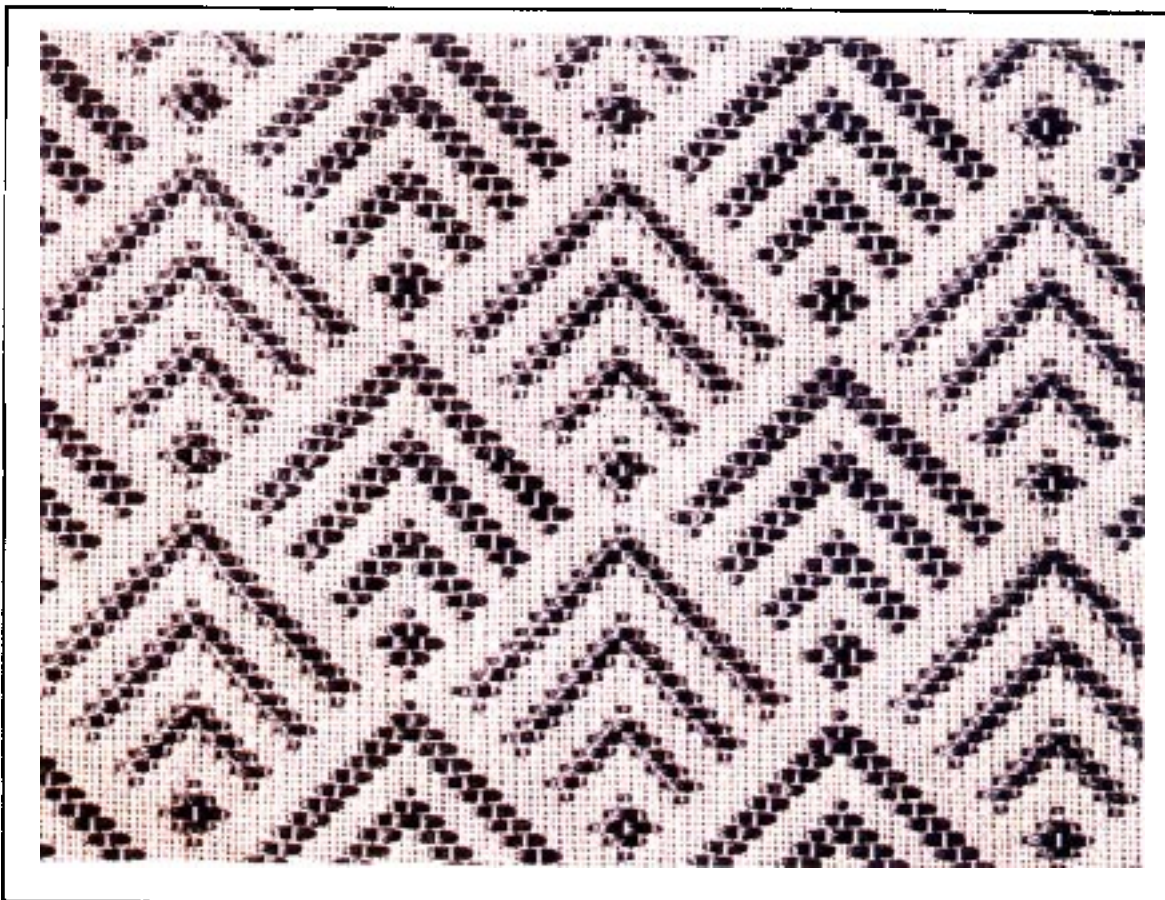

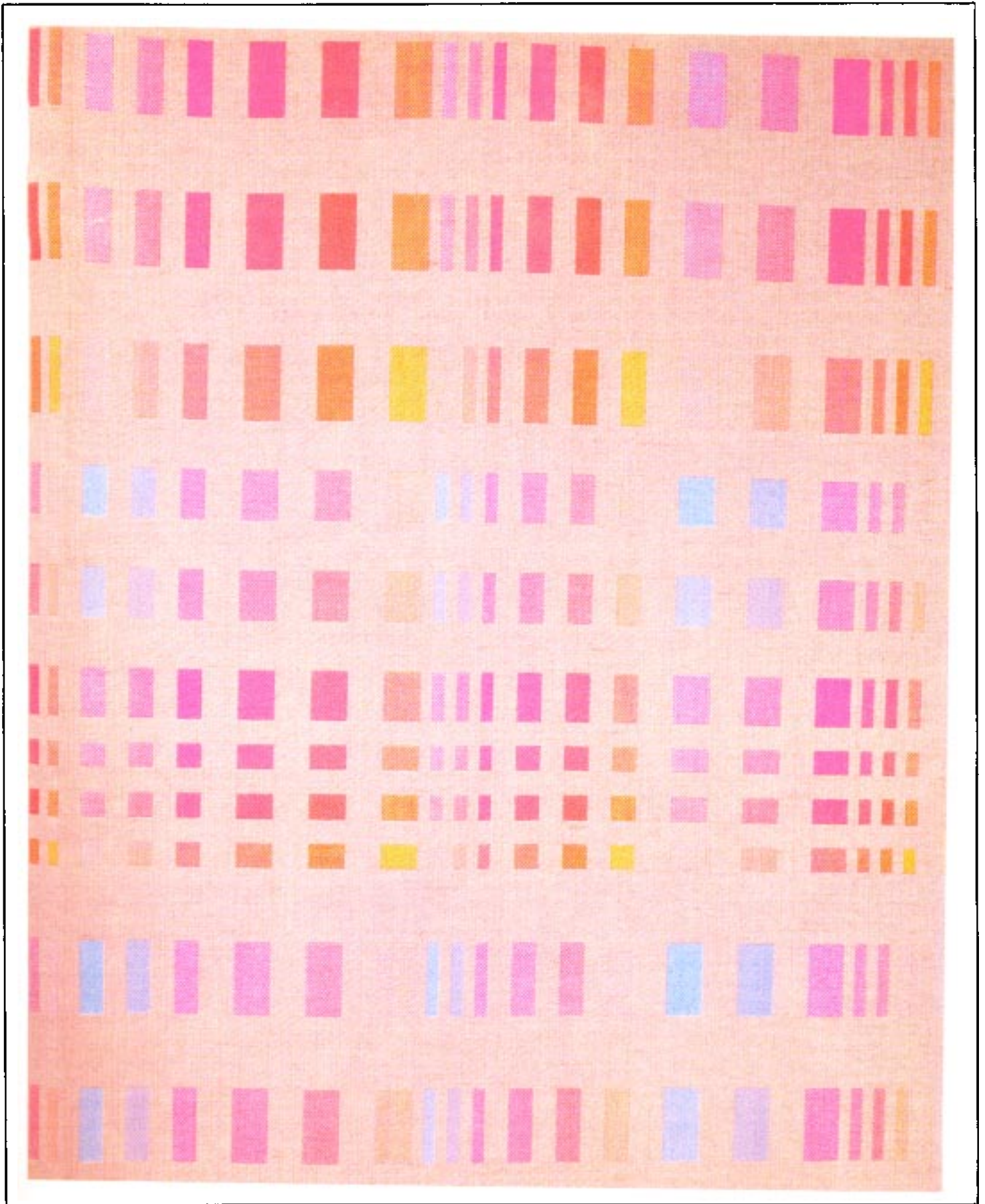

Photo 4. "Landis II." 100% wool double weave. Woven in New Zealand. Designed by Richard Landis and Larsen Design Studio.

competition. To achieve unity, the character must be dominant, all others subordinate.

And then, there is the question of function. Does a work achieve the purpose intended? Does it work superbly? Is the draping quality of the shawl or drape absolutely right? Is the light filtering through it spectacularly beautiful? How does it candle? What is the luminosity potential of the fabric? How is the hand? Is it wonderful—not only bearable—but is it exciting to feel? Does it feel right and well-balanced? These are sensitivities that a master craftsman learns through experience. Fabrics with these qualities need nothing more.

**6. Do you have rules for coordinating patterns, colors and textures? Can one acquire the aptitude for doing this successfully? How? Can one learn to use daring color combinations and achieve liveliness and excitement instead of producing color clashes and stress?**

Of course, the considerations under 5 are important. Larsen Design Studio is now finishing a co-ordinated collection of furniture coverings for the great Milanese furniture house, Cassina, in which we have spoken of each pattern group as having a 'grandparent', a 'parent,' and a 'grandchild'. The spectacular multi-colored patterns are the 'grandparents' designed for a drama different from the upholsteries on the market. The 'parents' are segments of the 'grandparent' fabric repeated over and over more simply, more architecturally, with fewer colors. The 'children' are simply texture patterns, backgrounds of the other two.

We often find that the economies and limitations imposed by production aid design coordination. Weaving with the same yarns and colors for related designs is a great economy at the production level, but they also provide affinity and a continuity in use. It also simplifies the yarn inventory.

Practice does make perfect. In considering color coordination and pattern correlation, concentrate on it, see it in the dress of people on the streets, and in rooms that seem particularly successful. Why are they successful? What is the relationship which points up the virtues of each aspect of the total?

As a gardener, I learn color from nature. I look at scintillating brilliance in flowers or in birds, I analyze why it is that this clash of color particles is so exciting. What prevents it from being vulgar? I usually find that brilliant color is made up of many different casts of the same red or blue, and that the texture is catching the light so as to heighten this effect. This is similar to Pointillism in painting, but with closer color values.

The brilliance is often set off with complementary "surround". Recently, I have been most interested in those red leaves which combine greens and reds of the same value. These complementary colors, which I have never used before, are the most exciting in our studio.

When I was a young weaver, I would put on simple warps and weave small samples by the mile. On warps which were only a few inches wide I would emulate barks and furrowed fields and rows of tiny plant cloches in those furrows. I would try to weave the texture of sand and gravel. I would imagine that I was an East Indian using exotic color. I would try to weave the brilliance of a mallard's neck, or a peacock's feathers, or all of the shimmering corals of a lobster or crab. I would try to replicate the luster of wheat-straw. That was all very useful.

Then, at another point, I did a similar piece but wider, using up all left-over bobbins. It was not beautiful, even though I enjoyed doing it. Mother cut it up to make place mats for me. What a good experience that was—to observe the tiny successes and failures in this Jacob's coat, each morning at breakfast. Artists are always sketching. Weavers need to sketch more, to practice, to train and retrain their hands and their eyes.

**7. Should an inexperienced weaver concentrate on understatement or be bold and experiment with color?**

Both, but 'bold learns faster.' Again, limitations are very useful. What can be done with only one dark and one light yarn, or what can be done with only one yarn? The best class I ever gave at Haystack was an assignment to weave a collection with one yarn in plain weave. We learned that a yarn

could be doubled and trebled and the importance of the sett in weaving very open and tightly closed. Different balances between warp and weft produced spectacular results. Many were sufficiently innovative that the students were able to sell them as designs for mill production.

How many combinations can be made of two yarns or three colors? I think this out quite mathematically. If there are numerous possibilities I will make a long list, then try out those which seem most likely—without inhibition. I simply enumerate them in the sample-making process, then use the objectivity of comparison to decide which to take to the next phase.

**8. In your book, *Fabrics For Interiors* you said you develop fabric color in a room in stages. How should a designer-weaver start? How should she progress? How will she know when the process is in its final stage?**

We must all start with the givens. What, in a room, cannot be changed—maybe some furniture will remain, or the stone floor or some surfaces. What will make these tolerable or even spectacular? Say, one has orchid tiles and fixtures in a 1930's bathroom. These can seem pretty vile or they can be made to seem very special. Often the way out is to use related tones, perhaps grayer. Do not try to play down the 'givens' but rather to play them up with towels and accessories, wall color as correlated as a Persian miniature. In our mass culture we do not need conformity!

Often, one has two colors among the givens which must remain: the sofa is a blue and the carpet another blue; they are not good together. Making bridges between them often works very well. If one has six blues in a room or in a fabric, they will almost always form steps between each other. This, of course, is the way that music is orchestrated, and the way individuals relate to groups. What is the common denominator? The discord?

Think in terms of the surround. The largest color areas in any room are the walls, ceilings, and floor. How will they be treated? My great teacher, Margaret Hosmer, said that she'd come to think that there really were only two ways to color a room. One, when it was



not distinguished by noble proportion or had details which should be eliminated. Then, the best solution would be to choose the light neutral one liked best—warm or cool—and simply balloon the whole room in that shape, to paint it out, and so make it seem as large and as non-objectionable as possible. On the other hand, a room with some character or graceful proportions or fine mouldings should be accented with color contrast. Perhaps the mouldings white against yellow walls. We do this with cosmetics all the time.

For many of us, a light neutral surround works best for the rooms in which we spend considerable time. I have enjoyed visiting anthropologists with neutral rooms highlighted with Navajo rugs and Indian baskets and old pottery: rich textures within an all neutral scheme. Usually, the more neutral the color scheme, the more dark-light contrast is possible. When more color is used, less dark-light contrast is desirable.

A living space is never finished. It grows and changes as we grow. I also feel a direct relationship between the amount of activity in a room and its color and pattern. Foyers, a seldom-used dining room, guest rooms, powder rooms suggest dramatic color; a room with a variety of activities, with music and books, wants ordered serenity. Most people mistakenly place their drama in their most-used space.

**9. What is the simplest and most effective way to deal with lighting in a home?**

The simplest, most effective way to deal with lighting is to experiment, often to eliminate. Light is the most important aspect of any environment—indoors or out. Eliminate glare. No light resource should ever be visible. Most interiors need lighting from many sources. I use light cans on the floor to bounce light upwards, for up-light is the most flattering to rooms and occupants. Dimmers have made it possible to orchestrate light in terms of requirement and mood. I can quiet guests by turning down the light, or stimulate them with floods of light.

Think in terms of accent lighting. What one or two or three aspects of the

room are worth special lighting? Leave the eyesores in shadow. And, then, there is task lighting for reading or working. There should not be much contrast between a task light and the ambient light surrounding it.

**10. How do you plan a room when night and day lighting differ very much and drastically affect the colors and textures in a room?**

Day and night lighting, if everything else is right, will be equally successful. At Larsen Studio we test our multi-colored fabrics by considering them in various lights. I take them to the country for the weekend and observe how they relate to changing lights. Common sense is so often the solution, but too general a light is not flattering to either texture or color. A luminous ceiling is the worst example, and fluorescent is usually destructive. When it needs to be used (I use a great deal of it for display cases), I am careful to see that the bulb is always shielded, and I now use a special tube from Westinghouse, Ultralume 3000, with the warm glow of incandescents. I like par bulbs for floodlighting and spotlighting. Available in most hardware stores, they are much more efficient than the ordinary reflector bulb, with twice as many foot candles per watt to reduce cooling costs as well. More than that, par bulbs provide an intensity similar to shafts of strong sunlight.

**11. In your book you said that fabric color designed for one part of the country may not work well in another place and climate. When a weaver works on a commission that will be installed elsewhere, won't her concepts be influenced by her own environment?**

**How do you try to guard against this?**

Experience certainly has helped me. I finally had to visit the tropics to find out why my fabrics were considered too heavy there, even when I had lightened them in New York. Be considerate with window fabrics.

We noticed early that the Southwest clients wanted dull neutral window hangings to reduce glare. In the dark canyons of our Eastern cities, they demanded the clean freshness of white. For Northern Europe, where light is extremely rare during the long winters, window fabrics must admit as much light as possible.

We have come to feel the density of window fabrics should be changed from exposure to exposure. For a south exposure we weave them more densely, on the north side more openly to admit light.

In working with our clients, we try to establish a dialogue, even if it is by Telex over a long distance. It is professional to ask questions and to find out as many ground rules as possible—what are their past successes and failures; what should we guard against? Think in these terms and be respected for it.

**12. Most weavers are aware of the importance of color, texture and weave structure in their work. However, they often know very little about the qualities of the yarn they use. Is it important for them to get information on the fibers used in the yarn?**

**Is this information available to handweavers?**

**Can a weaver really guarantee her product when she has no information on the yarns she has used?**

For handweaving, natural fibers are a 'natural.' For industrial use, synthetics are essential. But don't feel deprived not being without cheap commercial yarns.

We do test all the time. We weave, then finish, then test it for hand and other properties, especially abrasion. And then, we try again. Above all, beware of pilling. Spun polyesters and nylons will almost always pill, i.e., form fuzz balls. This is not a problem for window fabric but is for pillows and bedspreads, apparel and upholstery. Pills on wool or cashmere will tend to pull off with use, but when the fibers are as strong as nylon, they will hang on, getting uglier and dirtier each day.

Our swatch caps on all samples state, "not guaranteed against fading or wear." On the other hand, we are responsible and do test, constantly. Almost every university and most big cities have testing bureaus with testing devices. It is also quite possible to put bits of yarns on to two cards—one in a south window and one in a drawer, and then compare the results. Staple an upholstery sample on to the weaving stool, to see how it performs with real use.



Photo 5. Kelim group: "Grand Tour," "Chevrit," "Turkoman" and "Four Square." Rep weave, combed wool face, woven in the British Isles. Larsen Design Studio

**13. How can a handweaver take advantage of modern technology?**

Is there any way a weaver can make direct contact with the textile industry?

It is very difficult for individual weavers to make any kind of contact with real industry because, in this country we have very few small producers. In approaching industry, the public relations department will usually be the smallest and the most attentive. Or try Research and Development.

**14. Are there advantages to be gained if a weaver diversifies into fiber construction other than woven ones?**

I feel that working in other fabric constructions can be useful. We once worked in wet process, non-woven fabric constructions to find that all of these structures are based on triangulation, while weaving is based on a square. A square flattens to a diamond or a long slit and so provides great resilience. The non-wovens did not.

Out of this, we gained a new respect for weaving.

**15. How important is the use of handspun yarns in producing fabrics for the interior?**

I am sometimes quoted as saying that the great loss in the industrial revolution was not hand-weaving, but hand-spinning. We can make on power looms almost everything that handweavers can do, but not the natural rhythms and striations possible in hand-spinning yarns from ungraded fleece. When we have hand-spinning, the fabrics themselves can be very simple indeed. Neither color patterning nor the weave should upstage the beauty of these materials.

**16. Can one expect industry to furnish yarns with the qualities of handspun?**

It is, of course, possible for industry to replicate handspun yarn. The reason they don't is that they are so conscious of 'standards' and of eliminating

'seconds.' As a result, most production fabrics are as bland as Wonder Bread or bleached sugar.

**17. Is it practical for a handweaver to purchase a Jacquard loom to increase his potential for pattern weaving?**

A Jacquard attachment is a very complex piece of equipment, inappropriate for most handweavers. Some weavers, such as Ethel Stein, are now working on draw looms. These are so practical for handwoven production as to have been used for centuries. There is a good deal that can be done without them, if one has the patience to use shed-changing and pick-up.

**18. In the United States, the interests of the weaving industry seem quite separate from those of the students and graduates of art schools. Why is there so little communication and sharing of ideas and resources?**

Is there a chance that this will change?

I think the main fault here is that art schools tend only to teach design and

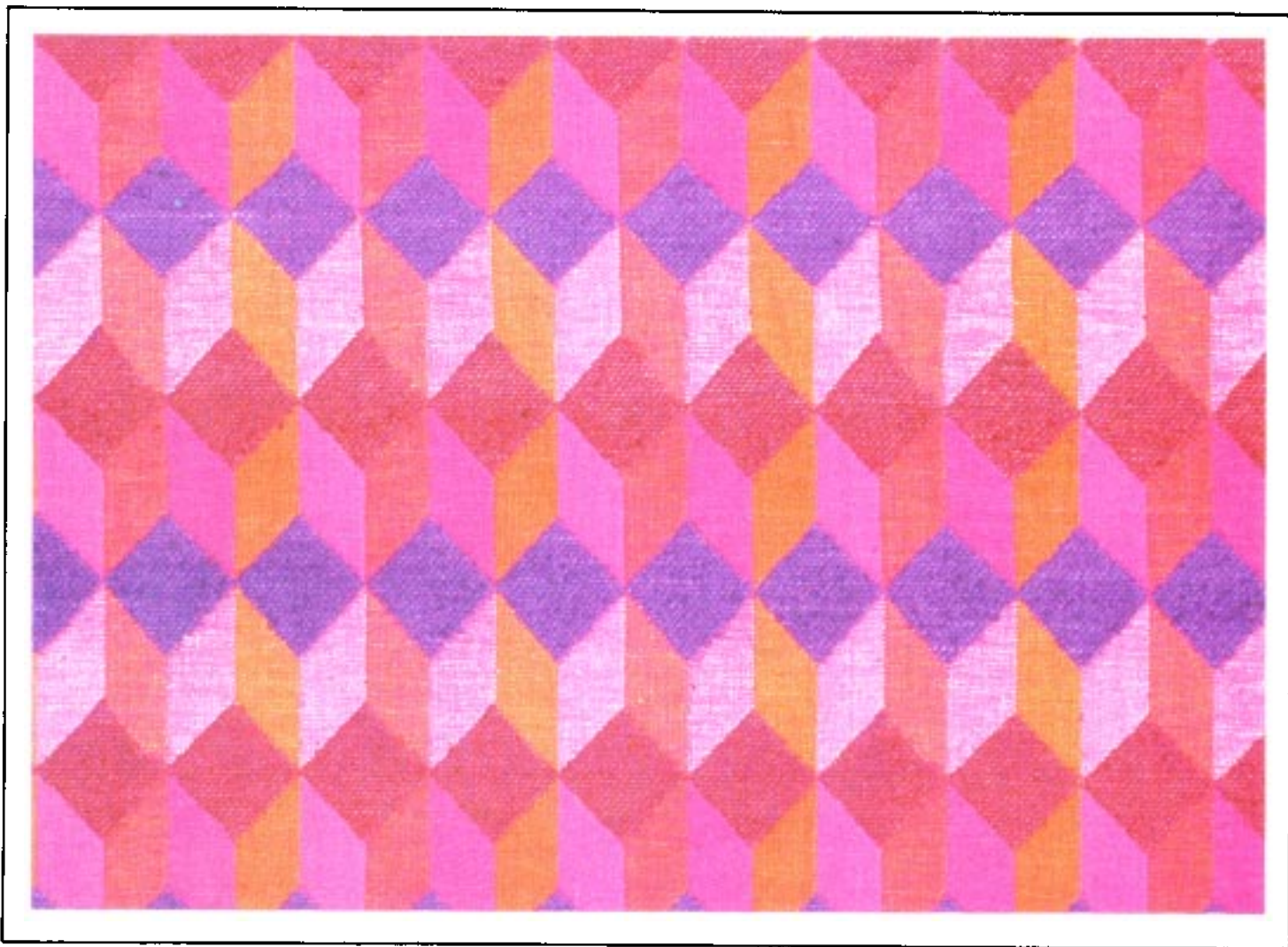

Photo 6. "Equation." 56% cotton, 44% silk. Handwoven in India. A Larsen Design.

aesthetics, not in terms of function or technology. Rhode Island School of Design is ahead in that they attempt to give both at once. I am much impressed with the intensive research going on there. It is unfortunate that textile engineers learn one language and designers another. This schism pervades industry, so there is almost never a dialogue between the two. This so limits American fabric design as to make experimentation impossible. As a result, our mass-production country imports most of its better goods.

**19. Your designs seem to unify art, handcraft and the industrial process. Do you ever have to compromise to achieve this?**

I don't like compromise. Sometimes I have to understand the market we are designing for, particularly when it is for a larger production, such as sheets and towels. But, what is the most one can get out of any particular situation?

In Haiti, we have very simple equipment, but we do have hand-spinning and hand-dyeing. In another place, we have commercial yarns but extraordinarily complex weaving equipment. We are always looking for potential break-throughs and areas-of-resistance. Trying to sell floral patterns to architects would fall into the area-of-resistance. Sometimes I find that I can use any technique or extraordinary color combinations if the pattern is familiar.

**20. Are there pitfalls in coordinating collections of fabric, furniture, carpets, etc?**

**Does the designer deprive the client of making personal choices about his environment?**

The pitfall of co-ordinated collections is that they are too often trite and considered in terms of a common denominator audience. One could also find resistance from interior architects not wanting to be dictated to by their suppliers.

**21. What do you consider your greatest contribution to interior design?**

At this point in time, I feel my major contribution is an insistence on quality and (sometimes) luxury, and providing a range of aesthetics and of fiber statements in a mass culture. I am keen to revive ancient techniques, such as ikat and batik, and use handspun yarns and the very best of materials. I want to continue doing 'what I don't know how to.' I am restless: I must continue with the Larsen tradition, but I am keen to expand it. And, of course, providing leadership. There are so many followers in our present-day world that I enjoy forging ahead. Leadership produces a kind of magic—a rare property today. I fear no other professionals. I have a new openness toward all aspects of fabrics and the pride of an amateur.

Thank you, Jack Larsen for your thought provoking answers.

# trends for

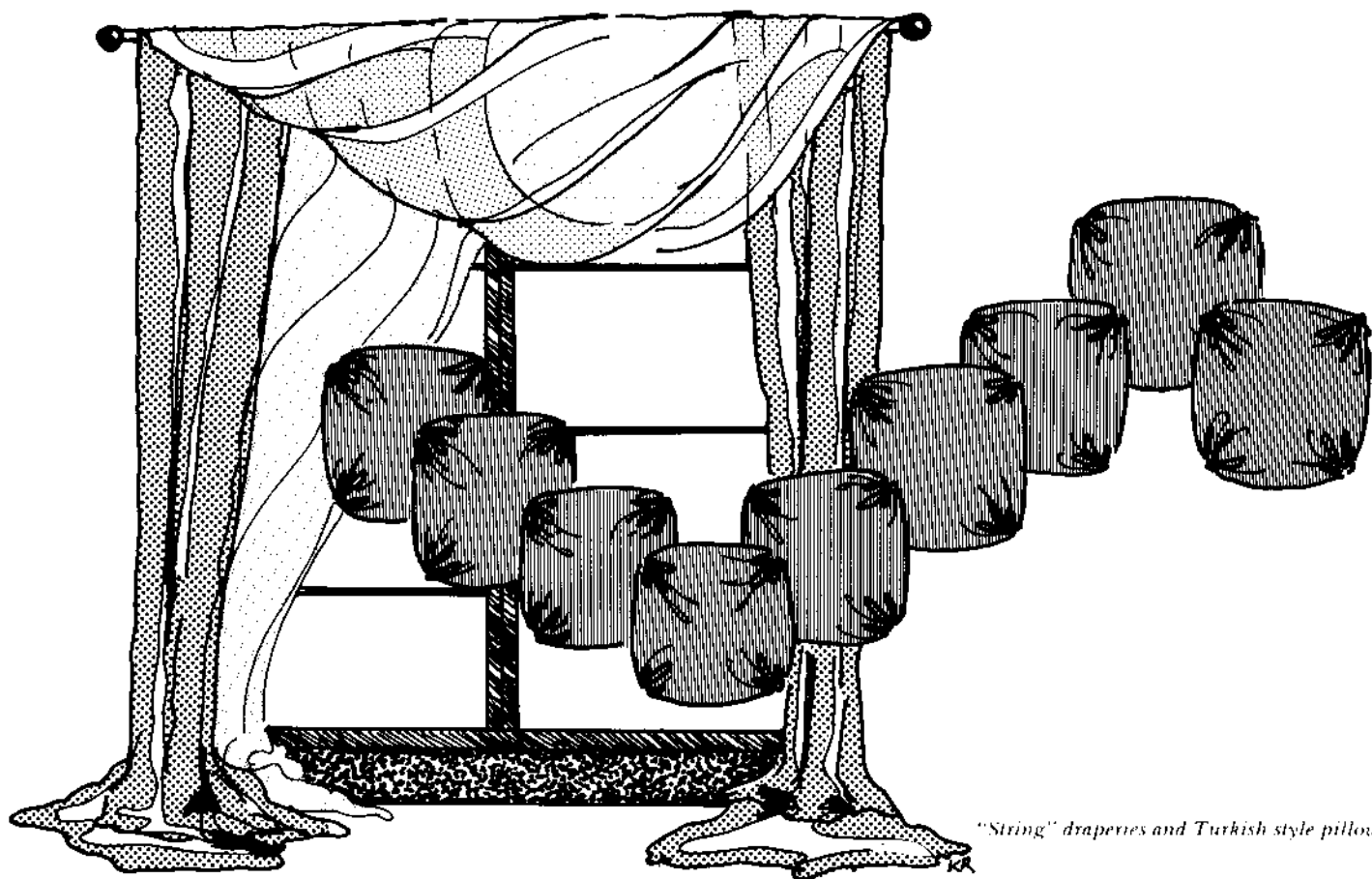

*"String" draperies and Turkish style pillows*

## fashionable interiors

by Susan Hick

Anticipating the directions in which designs for interior spaces will go is quite a different task from forecasting fashion looks. Change is slower, not season-to-season, tends to evolve rather than happen suddenly, and is not as whimsically dictated as are hemlines. The "perfect" rooms pictured in your favorite home-living magazines have more than likely been in place for a while and will stay that way even

longer, and manufacturers will continue to produce for those styles. All this helps the handweaver by allowing a bit more time pondering yarns, colors, textures, and structures.

To get a feel for colors and weaves, trends in styles can't be ignored. We've been inundated with the **Country** look for quite a while, but its enfolding comfort is sure to make it a survivor. Coun-

try can be anything from American farmhouse to sophisticated Scandinavian. Its main points are lighter woods, woven rush seats, rag rugs—all of which provide a marvelous background for collections from baskets to old glass to folk art. Wicker fits in here, too, even to a woven canopy bed. Basketry, anyone? **Traditional** (Colonial) gets a face lift, surrounded by darker walls and bold tartan plaids used as upholstery.

Just one to a room, please. There will always be advocates of what I call **Spare-and-Bare**, that look which allows nothing that does not belong. (What do they do with the travel souvenirs and Aunt Hattie's latest piece of decoupage?) The pendulum has swung from extra flat and uncomfortable to really fattened up and overly fluffed to now, pleasantly plumped. A throwback to the Art Nouveau and Art Deco periods, **Modern** has stylized florals or geometrics and even pieces reminiscent of the Thirties and the Forties. **Eclectic** is still very acceptable. A personal observation is that it is no longer a bizarre mixture of anything thrown together but a thoughtful presentation with an uncluttered feel.

The course of color is the most difficult for weavers to follow. Our yarn sources can't provide those we want until trends become established. Begin now to train the eye for colors that are soft, soft, soft. Pastels are not the ice cream hues of prior years but toned down, slightly greyed: celadon, taupe, mauve, dusky pink. The dark side of the designer's spectrum encompasses the rich colors that occur naturally: terra cotta, eggplant, spruce, slate, midnight. Helpful references are handpainted or embroidered Chinese silks, florals in 18th and early 19th century patterns, Oriental porcelains and rugs, Eastern paisleys, and Portuguese needlepoint rugs.

Upholstery fabrics used by interior designers for both industrial and residential applications are a source of suggestions for weaves that stand up to hard use. The  $\frac{2}{2}$  twill is shown with contrasting warp and weft colors; hues, however, have the same value, resulting in interesting combinations—light tones of pistachio and pimento, for example—that sparkle rather than complete. Popular are windowpane checks, herringbones, rib weaves, basket weaves, satin checks and stripes, and canvas weave spots. With care in the planning, a small bird's eye can have the look of a "pin dot" pattern. Channel quilting adds the comforter look to upholstery. And rag rugs are for covering furniture as well as floors.

Consider using tussah silks in varying weights for their textures and natural color variations. Chenilles are wonderful. Don't forget a hint of a glint now and then from a metallic.

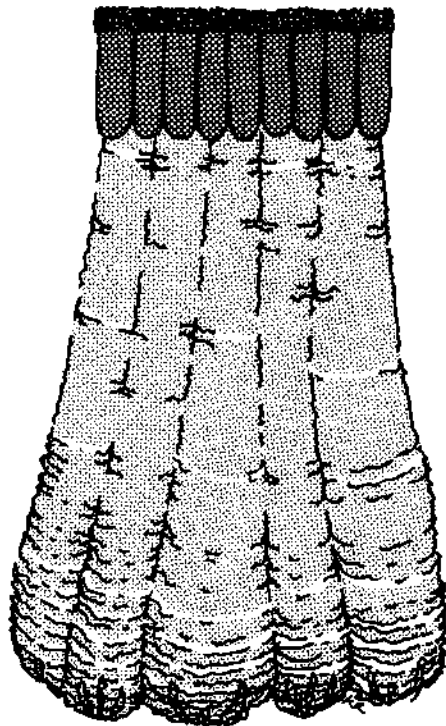

*"... a voluminous shirred mass of fabric that balloons at the bottom."*

The American folk tradition inspires designs. Motifs from Native American rugs, botanical prints, and patchwork quilts are contemporized and abstracted. Ikat and warp painting are just two of the ways to incorporate these. Or I suppose you could weave and stuff a replica of a wooden decoy.

Throughout it all the advantage to handweavers is being able to work up coordinated fabrics in different patterns and colors.

Pillows absolutely abound. For couches, love seats, window seats, chairs, and beds it seems that no one can have enough. They tend to be all the same size on each piece of furniture, and while some may match the solid color of the piece, others add accents not necessarily monochromatic but in the soft tones. Arrangements may look casual but are really studiously placed. Shapes begin as squares; then the corners are gathered into the rounded "Turkish"

style. Cording may or may not be included in the seam.

There are enough window treatments to delight the creative weaver. All manner of shades are seen. The old roller ones are covered with woven fabrics, from double weave to plain to twill. Another shade is a cross between Roman and Austrian, a voluminous shirred mass of fabric that balloons at the bottom. Still a third possibility is shades with the look of the popular one-inch blinds, formed by horizontal pleats.

"String" draperies are just great cascades of soft cotton with widely spaced woven bands to keep everything in order. Michael Graves, architect and designer, often simply drapes a long length of fabric over a brass rod. What could make a more effective statement?

More and more, people want to consider the insulating effects that can be incorporated into room decor. Quilts for windows are one method. Energy Alternative Systems Inc. of Seattle offers Warm Window: Roman shades which feature a four-layer insulating fabric and magnetic edge seal. The decorative fabric of your choice is added to the interior side, perfect for a handwoven. The hardware, insulation, and how-to are available through some fabric stores.

Cloth has long been used on walls. Why not handwovens? Heavily-textured upholstery fabrics can be used this way for their insulating and soundproofing qualities, not to mention concealing damage. There is now even a "thermo-reflective" wallcovering which contains an aluminum layer with an infra-red transparent dye that reflects the heat back into the room. As with everything, fireproofing should be thought out carefully.

Someone once said that what we decorate ourselves with today we'll use to decorate our rooms tomorrow. So if your blue-sky-and-clouds, bright orange, turquoise, or desert sunset yarns didn't get made into a Santa Fe skirt, don't despair. You can be sure that New Mexico interiors will soon be a Hot Look!

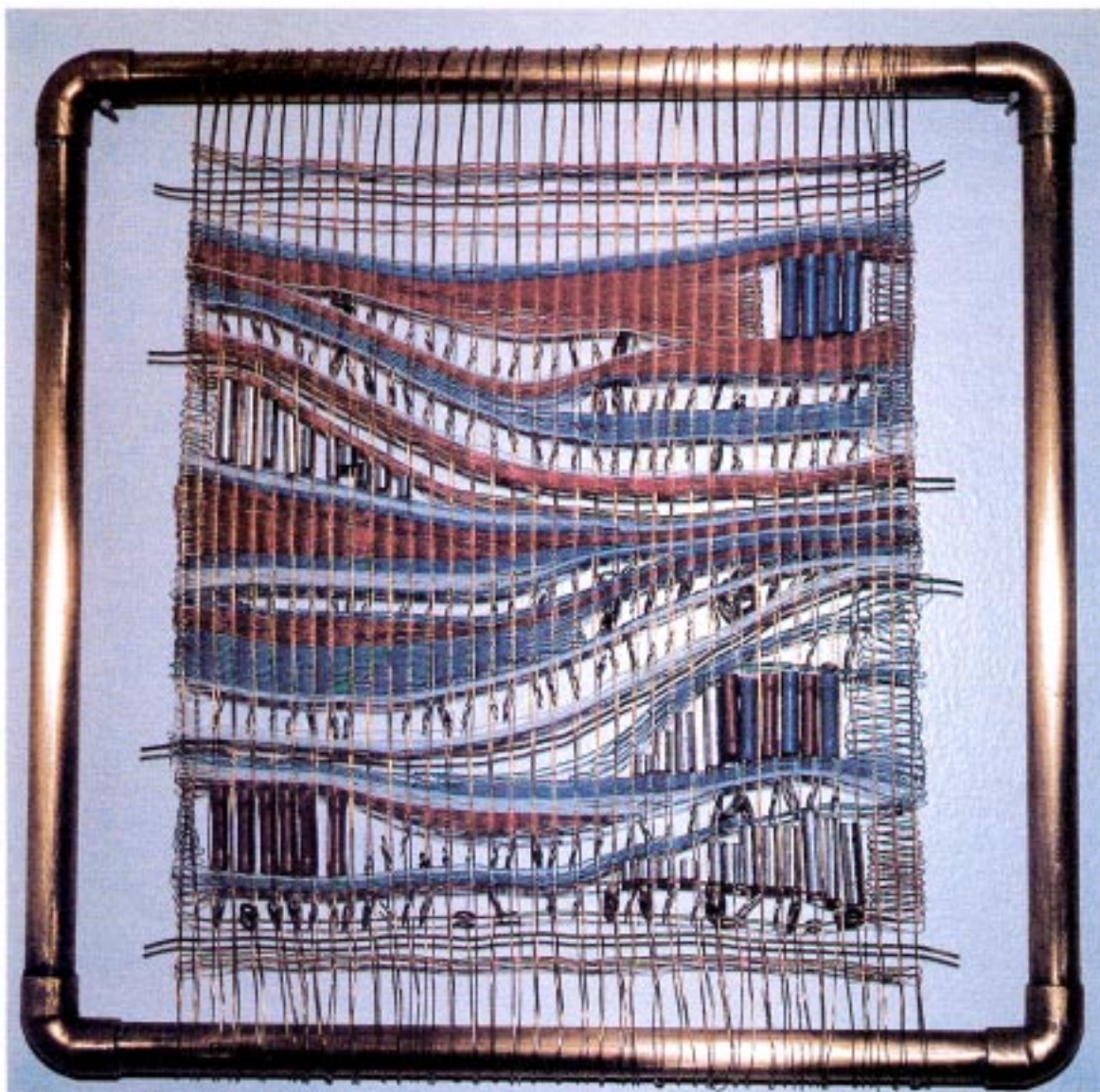

# INTERFACE: A WIRE WEAVING

by Donna Sullivan

My husband likes to tinker with electronic components, so my home is littered with bits and pieces of hardware in the few places currently unoccupied by yarns. One day I happened upon some wire wrapping wire from Radio Shack. It was thin and flexible and a nice bright pink. I asked a few questions and learned it is also available in blue and white. Now I was interested, so I looked on my husband's workbench and rummaged through his stacks of storage drawers. He was eager to help. What a find! I discovered many fascinating connectors and spacers, which I now viewed with something other than disdain, much to my husband's surprise.

After drawing a rough draft of a design, I used 30 gauge copper wire to warp a frame loom 8 epi (30/10 cm), inserting flat washers and spacers where planned. I used the wire wrapping wire as the weft and inserted a couple of rows of slightly thicker wire I also found. The wire wrapping wire was not difficult to work with. I left all the hardware at the top of the loom and brought down each piece as needed. Uncertain about the best way to mount the finished weaving, I went to the local hardware store and wandered around until I located some copper tubing. My excitement about finding a mounting that would relate to the copper warp was somewhat

dulled by the difficulty of soldering each wire to the back of the tubing without loosening the nearby wires. I am open to better suggestions for mounting future metal hangings.

The finished weaving measures 13" X 13" (33 X 33 cm). I had fun making this hanging, partly because I was using materials new to me, and largely because my husband really enjoyed watching me weave our two hobbies together. Perhaps your husband (or boyfriend, father, brother, son) has a hobby you have not yet explored as a source of weaving inspiration!





**THE GREAT COMPETITION FOR WEAVERS!!!**  
SPONSORED BY THE WEAVER'S JOURNAL

**UP TO \$1200 IN PRIZE MONEY . . . . FOR YOU!**

It's easy! Just submit a written article on a successful project in which you used a weaving technique in a creative way. Enter your project in one of the following categories:

- Rugs
- Household furnishings
- Handspun yarn woven projects
- Handwoven clothing

Only one entry per category, please. All entries will be judged by the editors of The Weaver's Journal. Emphasis will be placed on originality of the project, its aesthetic value, and good craftsmanship including finishing. The text should contain the necessary information and instruction needed for the reader to understand the processes involved. The winners will receive \$100 for each winning article.

The Weaver's Journal must receive the right for first publication of the winning articles. All accepted articles will be published before July 1, 1984. All materials will be acknowledged upon receipt and will be returned later to the author. If the photos sent are not of professional quality, the objects must be available to be mailed to The Weaver's Journal where they will be photographed. All mailing expenses for photographic purposes will be paid by The Weaver's Journal.

**Contest deadline: April 15, 1983**

**Mail manuscripts to: The Weaver's Journal, P.O. Box 2049, Boulder, CO 80306**

**Contest Rules**

1. Text must be typewritten, triple spaced.
2. Drafts and line drawings must be on separate sheets of paper and numbered.
3. Photos (B/W and/or slides) must be accompanied by a list of captions.
4. The upper left-hand corner of the first page of the manuscript should contain contestant's name, address, and category entered.
5. Include a small sample of yarns used and mention the name of the supplier, if possible.

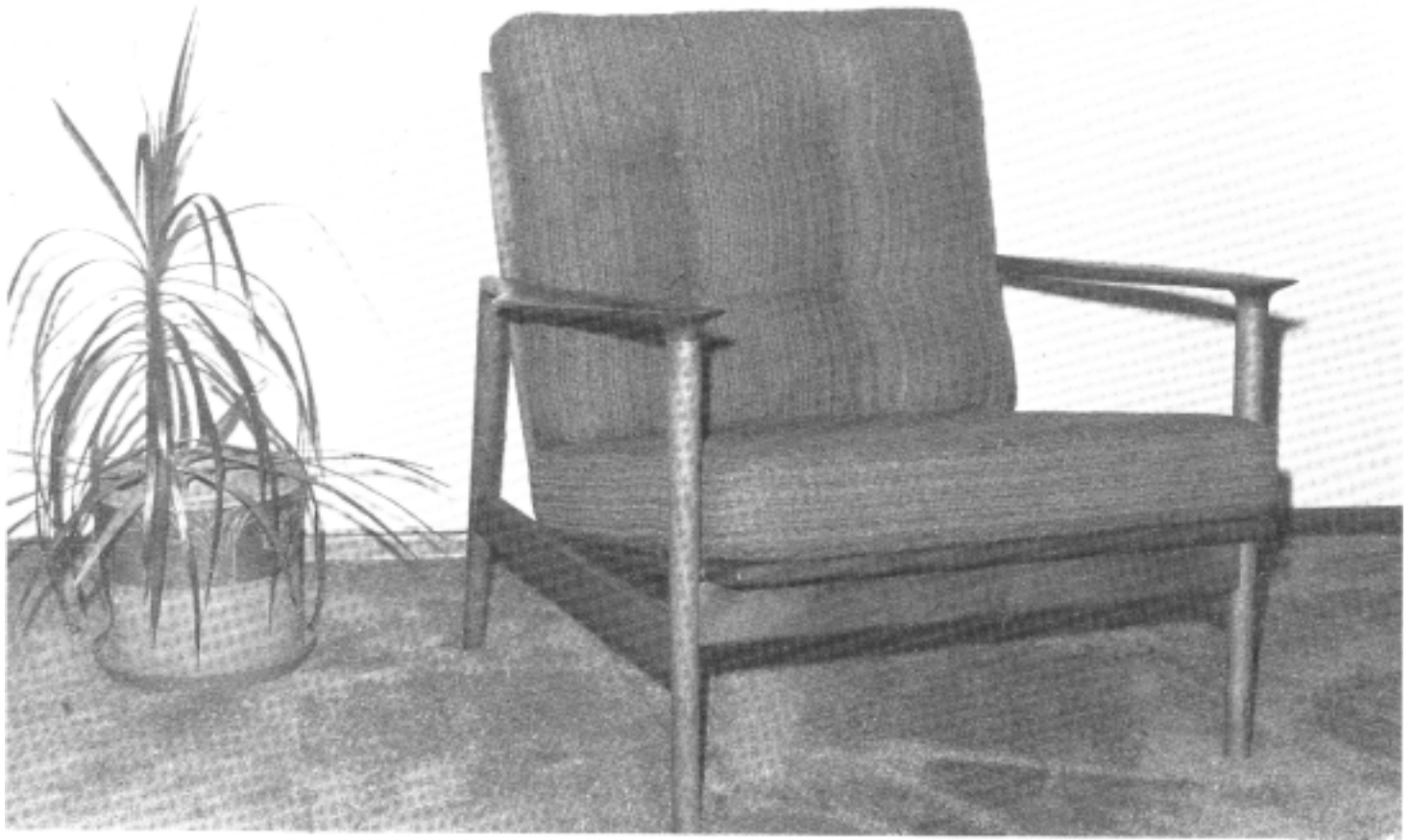

# UPHOLSTERY

by Maxine Wendler

The two Danish chairs that required reupholstering have wooden frames and two cushions each without cording.

Plain weave cloth is well suited for upholstery fabric because of the tight interlacement of the weave. The fabric should be firmly beaten and in general only fine yarns should be used except for an occasional heavy yarn for texture. The subtle texture of the yarns and the color blending of various browns give the cloth surface interest and sparkle.

**WARP:** 5 different fine warp threads plus 1 alpaca thread in every inch (2.54 cm) of warp. 1120 yards (1024 m) each of the fine threads, 280 yards (256 m) alpaca.

**WEFT:** 4 different fine threads wound together on the shuttle.

**SETT:** 20 epi (80/10 cm)

**WIDTH IN THE REED:** 35" (90 cm).

**LENGTH OF THE WARP:** 8 yards (7.31 m).

**WEAVE STRUCTURE:** Plain weave, firmly beaten with 15 picks per inch (60/10 cm).

**SIZE OF FABRIC OFF THE LOOM:** 33" X 6 yards  $\frac{3}{4}$ " (84 cm X 5.5 m).

**SIZE OF CUSHIONS TO BE UPHOLSTERED ( 2 CHAIRS):**

2 cushions 20" W X 22" L X 3 $\frac{1}{2}$ " H (51 X 56 X 9 cm)  
2 cushions 22" W X 22 $\frac{1}{4}$ " L X 3 $\frac{1}{2}$ " H (56 X 57 X 9 cm)

**MATERIAL NEEDED:**

4 pieces 21" X 23" (53.3 X 58.4 cm)  
4 pieces 23" X 23 $\frac{1}{2}$ " (58.4 X 59.7 cm)  
2 pieces 4 $\frac{1}{2}$ " X 68" (11.4 X 172.7 cm)  
2 pieces 4 $\frac{1}{2}$ " X 70.5" (11.4 X 179 cm)  
2 pieces 5 $\frac{1}{2}$ " X 18" (14 X 45.7 cm)  
2 pieces 5 $\frac{1}{2}$ " X 20" (14 X 50.8 cm)  
2 zippers 16" (41 cm) long  
2 zippers 18" (46 cm) long



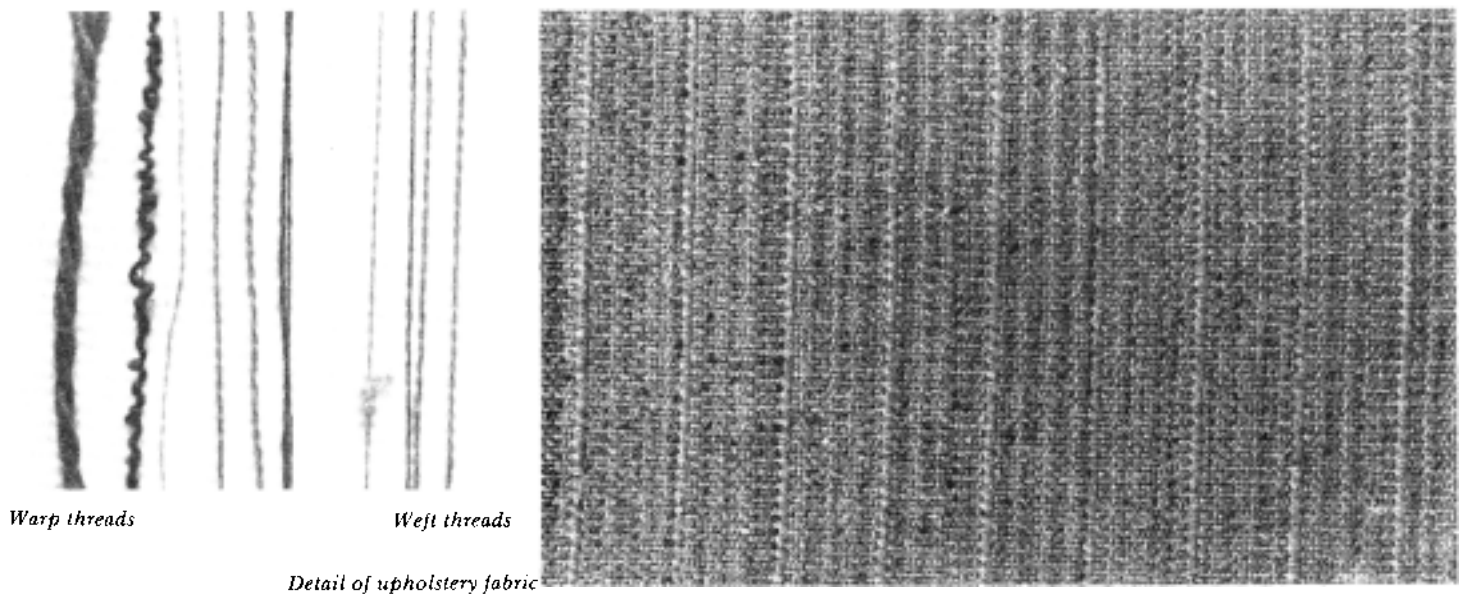

Cut cushion pieces and boxing strip 1 inch (2.54 cm) wider and 1 inch longer than finished measurements, this is allowing for  $\frac{1}{2}$  inch seam allowance. Each pillow requires 2 pieces of boxing strips. The first should be two lengths and one width of the cushion plus approximately 4" (10 cm). The second should be 2 inches (5.1 cm) wider than the height of the cushion and be the length of the zipper plus two inches. The zipper should be approximately four inches shorter than width of cushion.

Cut the shorter pieces of boxing in half lengthwise, then sew 1" at each end, (Fig. 1). Press seam open and install the zipper. (If the zipper is too long it can be cut off after

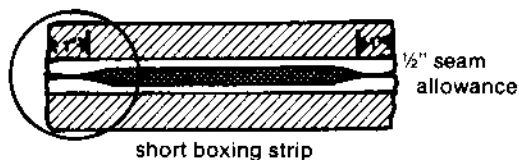

FIGURE 1

short boxing strip

stitching across zipper teeth several times to provide a stop). When stitching down sides of zipper, do not stitch the last  $\frac{1}{2}$ " at either end, Fig. 2.

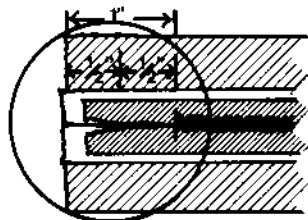

FIGURE 2

Sew one end of the boxing strip with zipper to one end of long boxing strip with a  $\frac{1}{2}$ " seam allowance.

With right sides together, and starting with zipper end of boxing, pin boxing to one of the cushion pieces starting approximately  $1\frac{1}{2}$ " (4 cm) in from corner and leaving the first  $\frac{1}{2}$ " for joining the other end of boxing, Fig. 3. When

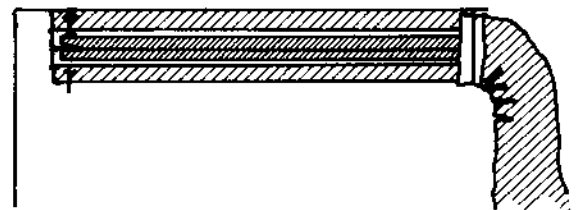

FIGURE 3

going around corners, place a pin in corner at an angle as shown in Fig. 4. Line up fabric edges of cushion and boxing pieces, and continue to pin the pieces together.

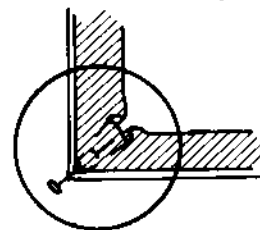

FIGURE 4

With the boxing piece up, machine stitch seam to pin, pivot sewing machine needle and fabric pieces and sew down next side of cushion to pin, etc.

Now mark corners of boxing for placement of second cushion piece by folding the boxing at corner and lining up side edges; place a pin at fold on raw edge. Sew second cushion piece to boxing, starting again at zipper end. Sew to within  $\frac{1}{2}$ " of pin, pivot needle and stitch to within  $\frac{1}{2}$ " of next pin, and so on.

Stitch ends of boxing together.

Chair back cushions may be finished with covered upholstery buttons. The buttons have a metal shank. A strong cord is tied to one button, then threaded on a long upholsterer's needle and pulled through to opposite side of cushion and pulled down as much as desired, then tied to a second button. Cord is then clipped close to button. An upholsterer will cover buttons and place them on your cushions for a very nominal fee.

The cushions were sprayed with "Scotch Gard" fabric protector, following manufacturer's directions.

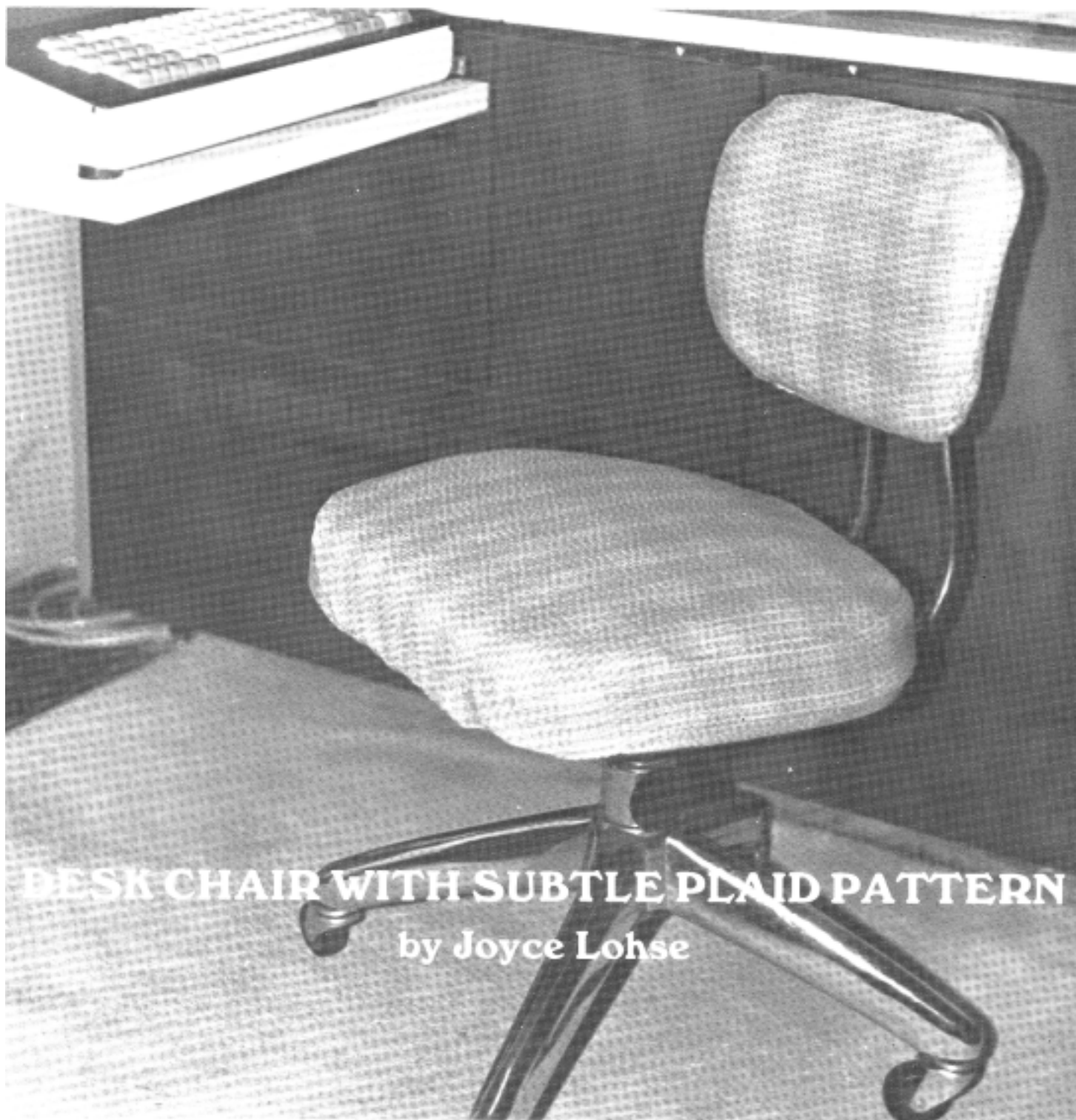

## DESK CHAIR WITH SUBTLE PLAID PATTERN

by Joyce Lohse

When my swivel desk chair started accumulating holes in its frayed upholstery, I decided to weave a sturdy, new fabric to cover the abused chair.

Choosing materials was the first order of business. Pearl cotton (3.2 mercerized) seemed to be a good choice as it is sturdy and washable. Off-white and gold colors were chosen to replace the drab, dark green of the old fabric in order to lighten the chair and coordinate with the same colors used elsewhere in the office.

To make a sturdy upholstery fabric, I decided to use a plain tabby weave and add a subtle design by the arrangement

of the two colors in the warp and the weft. A tight weave would be necessary so I decided on a 15 end per inch (60/10 cm) sett, slewing 3 ends per dent in a 5 dent reed.

In order to figure yardage, I measured the old chair fabric while still on the chair at its widest point and allowed extra for the seams. My measurement was 24" (61 cm), so I decided on a 28" (71 cm) weaving width to compensate for draw-in and shrinkage later; this worked out very well.

For length, I measured the length of the old chair seat fabric, plus that of the chair back, taking care not to forget fabric used on the back for facing, seam allowance and extra

facing used in attaching the total covering to the chair. My measurement here was 5 feet (152 cm) to which I added 3 feet (91 cm) for sewing leeway, loom waste, and shrinkage. Thus the 8 foot (2.4 m) total warp length was just right.

At 15 ends per inch with a 28" weaving width, 420 ends are required. 420 ends with 8 feet of yardage requires 3,360 feet or 1,120 yards (1024 m). In order to achieve the balanced tabby plaid pattern, an equal amount of each of the two chosen colors will be needed. That means 1,680 feet or 560 yards (512 m) of each.

Sleying the reed at 15 ends per inch will require 1 end per dent in a 15 dent reed, or 3 ends per dent in a 5 dent reed, or alternate 1, 2, 1, 2, etc. in a 10 dent reed. A 2- or 4-shaft loom with 28" or more weaving width may be used. Tie-up is simply for a plain tabby weave.

Weaving the weft requires alternating 10 single yarn shots of off-white with 10 single yarn shots of gold throughout the project, which creates a subtle pattern on the rugged fabric.

Once the fabric is woven, it should be removed from the loom, the two ends of the fabric zig-zig stitched on the sewing machine to prevent ravelling, then washed using the same process you would use should the fabric become soiled in the future. Use your washer and dryer on gentle cycles and a gentle detergent, then iron to remove wrinkles. The fabric should now be shrunk and ready to use for upholstery.

Your pattern for the upholstery will be the fabric you are replacing. Simply remove it from the chair taking care to note how the chair comes apart and how the fabric is attached to it. Put screws and fittings in a safe place and DO NOT throw away the old fabric—it is your pattern.

Now comes the time when you gather your courage and a pair of sharp scissors, and with the old fabric pinned to the new, cut out pieces in the same shapes used to construct the old fabric. Make sure to add  $\frac{1}{8}$ " (1.6 cm) seam allowance to the sides where the seams will be constructed, or hems sewn. Think ahead, position the old fabric carefully in order not to waste new fabric, and you should have no problems.

Once the pieces have been cut, immediately stay-stitch around the cut edges about  $\frac{1}{8}$ " in (12.5 mm) at 10 stitches per inch (40/10 cm) on your sewing machine. Then sew the new pieces of fabric together (using a 10 to 12 stitch per inch setting—according to your particular machine) still using the old upholstery as your model and guide noting every detail and measuring carefully at each step.

Now you may give the new fabric a trial fitting over the form of the chair it will be covering. You might take this opportunity as I did to take a foam pillow form, cut it to size, and give additional padding to the tired chair. A little foam adds alot of comfort. At any rate, you will want a good, snug fit. Make any adjustments to tighten up seams if needed, then put the fabric snugly into place and attach just as the old fabric had been, making any adjustments or improvements as you see fit.

With the new fabric in place, and after a trial sitting giving you the assurance that all is well with your new hand-woven upholstery, you may now, at last, throw away the old fabric.

You are basically finished with the project except for one detail for which I thank my mother . . . obtain a can of "Scotch-Guard" and spray the new upholstery in order to resist stains. This will surely save hassles in the future. Beyond that it is happy sitting for you.

**WARP:** 3/2 perle cotton in two colors, off-white (X) and gold (●)

**WEFT:** Same as warp

**SETT:** 15 epi (60/10 cm)

**WIDTH IN THE REED:** 28" (71 cm)

**TOTAL NUMBER OF ENDS:** 210 (X) and 210 (●)

**LENGTH OF THE WARP:** 8' (2.4 m)

**COLOR ORDER OF THE WARP:**

gold	1	1	1	1	1	1	1	2	2	2	2	1
white	1	2	2	2	2	1	1	1	1	1	1	1

← repeat →

**THREADING, TREADLING, TIE-UP:** Plain weave

**COLOR ORDER IN THE WEFT:** 10 picks white, 10 picks gold, repeat.

# DOOPHLIQUE

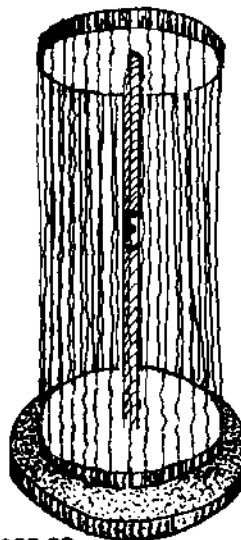

\$30.00  
10" x 24"

- It is so simple and easy that anyone could weave on it, even a child, an invalid, the handicapped.
- It warps and weaves quickly and the whole weaving can be seen as you progress.
- It saves warp as compared to a table loom—the extra yard for tying on is eliminated.
- It doesn't take a lot of strength and is good finger exercise.
- It's probably the most relaxing loom there is. It's light weight, fits comfortably in your lap whether you're in a chair, on the floor, in a hospital bed, or in the car.
- It even is an attractive piece of art just sitting warped on the living room floor!

PLEASE MAKE CHECKS OR MONEY ORDERS IN U.S. FUNDS PAYABLE TO:  
DOOPHLIQUE LOOMS - BLUE HILL FARMS #2949 DEWEY, AZ 85637



photo by Alex King

Allen Fannin

# LOOMING THOUGHTS

by Allen Fannin

As long ago as April of 1950, in the presumably (and sadly) defunct *Handweaver & Craftsman* magazine, its founding editor, Mary Alice Smith, said in her first editorial, "The adaptation of the work of the artist-craftsman to the necessities of mass production is not a simple process. For this reason it would seem to be important that the handweaver and the producer of machine-loomed textiles understand each other better." She continued, "Handweaving is not, as many suppose, a nostalgic retreat to a simpler and perhaps pleasanter economy—though no one interested in the craft can neglect the valuable traditions in which it is rooted—but an active force in the production of materials for satisfactory modern living."

In the more than thirty years since those concepts were presented, we have all been witness to, and perhaps even victims of, a great many of society's movements and changes. The handloom weaving field has been no less a recipient of the effects of these social eruptions, which makes it almost imperative to conclude that really nothing sane can function as a "... retreat to a ... pleasanter economy". The closer communication

between hand and power weaver and the placement of handloom weaving as a viable textile resource that Mary Alice Smith suggested are, to this observer at least, essential to the healthy development of the field. Yet from this writer's perspective, the field seems to have digressed from anything resembling these two ideas over the past thirty years. The strange, tempestuous and, yes, questionable, marriage between the art and crafts worlds has done little towards retracing handloom weaving's steps back from this digression. Were this union more as Ruskin and Morris had envisioned, handloom weavers might now be occupying a quite different position.

One can only speculate as to whether the path down which the handloom field has digressed has severely narrowed its base. Though one cannot deny the seeming variety of approaches to the weaving craft among today's handweavers, we would caution that at a very basic level, there is less variety than appears; but this involves an entirely different and separate discussion. However, even at a superficial level, handloom weaving is missing certain variations of approach that characterize and give a

broader base to the foundation on which so many other human pursuits are built. If we may be permitted to speculate further, we might compare handloom weaving to photography, for example. Even a shallow perusal of the popular trade literature would reveal a field of photography whose breadth handily encompasses everything from Ansco to Zeiss; where there may be little difference in skill between serious amateur and rank professional; where a wealthy week-end novice may be more well equipped at the Zeiss level than a street-worn news pro, with no stigma on either position. Handloom weaving is less fortunate, lacking even something close to the Zeiss level in equipment or concepts. The same comparison could be made between the textile crafts and many other fields.

In her article "Commitment" in *Handwoven* magazine of September 1981, Constance LaLena commented that, "We can choose what level and type of involvement we want for ourselves within the world of weaving." Would that it were possible. We have more than just passing acquaintance with many who have left this "... world of weaving" precisely because they did

not find the level of choice and challenge of which their minds were capable, not to speak of economic returns.

Lest the reader misunderstand, our aim is not to apply the sort of peer pressure towards professionalism that Ms. LaLena alluded to in her article. Quite to the contrary. We are only seeking the same breadth of choice for handloom weavers as is available to participants in other human endeavors.

At each stage in the evolution of any human endeavor, people are faced with decisions that can, if made with vision, lead those engaged in that endeavor into directions that are not only new, but at the same time well in keeping with a natural growth process. We have, in our own twenty or so year involvement with handloom weaving, seen the result of many a decision that proved to be more self-defeating for its having been made with little vision and broad thought. We were recently pleased to have engaged in a dialogue with a mechanical engineer whose wife is a weaver. He drew an intriguing parallel between the type of thinking behind the design and construction of most hand textile equipment and that of most present day wood-burning stoves. His argument was that most designers and builders of wood stoves decided to take their cues from the stoves of the past with only minimal penetration into more modern technology. He indicated that the better decision would have been to look to the pyrotechnology of incineration for principles that would yield a product of far better design for its function, rather than merely changing the packaging around the old pot belly and making up for the difference by advertising claims of questionable credibility. Historically, we have seen evidence of far more advanced developments in handloom weaving and handspinning equipment thirty or forty years ago than now. No genuinely new hand yarn spinning equipment has emerged since Mr. Ham developed his yarn spinning machine in Connecti-

cut in the late 1930's and early 1940's. Handspinners are still spinning one end per spinner when Hargreave's jenny is a well documented fact several hundred years old. One can only wonder why modern potters were more accepting of a motor powered throwing wheel than handspinners are of a motor driven spinning device or of a device that would allow one spinner to do more than one end at a time.

The same lack of vision in the design of hand textile craft equipment is seen in the kinds of decisions that are made or, more important, not made at various ideological turning points in the history of the field. In her guest editorial in the March 1970 *Shuttle, Spindle & Dye* magazine marking the beginnings of the Handweavers Guild of America, Else Regensteiner admonished, "All will agree that their [HGA] efforts must be directed towards the establishment of standards which are very high . . .". Subsequent efforts to that end do leave some doubt. This admonition implies a certain turning point in the organization of handloom weavers coming as it coincidentally did at the end of Mary Alice Smith's tenure as publisher of the *Handweaver & Craftsman* magazine with her death in October of 1970. It also implies one of the kinds of opportunities which, contrary to popular adage, usually knocks more than once; an opportunity which, if recognized, can open more doors than one might initially imagine. Yet if we examine the leadership offered by the national organization of weavers in taking the field into broader areas and making textile craft work more of ". . . an active force . . .", we find it seriously wanting. In a previous column written in reaction to the first Convergence held in Detroit in 1972, we remarked on the narrowness of the population of the handloom field. Leslie Tillett, in a speech delivered to a much more recent Convergence, made an almost verbatim reference to the same concept. Ms. LaLena cited a study in her article which statistically documents the point.

The first step towards the solution of any problem is the admission that there is a problem. We suppose therefore that the question must be asked: Is hand textile craft all that it could be? Despite the shortcomings of national leadership, we would still look nationally for possible answers, and at the time of each Convergence we look hopefully for any kind of result from these gatherings that would contribute positively to what is needed, rather than maintaining things as they are. We were present at the first words that were spoken that resulted in the Convergence held not too many years ago in Colorado. A great many opportunities existed at that time for badly needed rethinking of handweaving's priorities. Fortunately, because of the resourcefulness of the people involved in the earlier stages of that Convergence, a good measure of the opportunity was realized. One can continue to look to these biannual gatherings as the principal means by which participants in this craft can be exposed to a dialogue of ideas which so desperately need to be exchanged. Whether the effects of these exchanges will be felt beyond the conference gatherings themselves will depend on how important they are to the people involved. For too long, many in this field have taken a self-deprecating attitude as to their ability to deal intelligently with what they do. So many times we have been told at a workshop, "Oh, my husband understands that but I never could.". If we have any insight into the situation at all, we would have to say that it is much more than just a nuts and bolts problem and cannot be solved or even studied by a simplistic, how-to approach. We are finding increasing interest in the whole craft movement on the part of those outside of but peripheral to it. It is quite possible that, as in other important discoveries, some answers may just come from them. This writer will be looking with great interest, hope and, certainly, optimism.

Kind regards and thanks. ■■■

© Copyright Allen A. Fannin 1982

# TAKE IT EASY

## WOVEN FELTED BOOTS

This is a project that can be woven on a 20" slot and heddle loom or on any other two-shaft loom. The weave structure is plain weave, woven loosely and with an easy beat. The woven fabric is machine washed in hot water to make it felt. The felted cloth does not unravel and the seams can be sewn by whipstitching the two layers together.

**WARP:** Single spun wool, natural white, in a size that yields about 668 yards per lb. The Navajo tapestry wool used for this project may be available at your local store or can be ordered from the Navajo Wool Marketing Industry, P.O. Box 719, Shiprock, NM 87420. Amount needed: 12 oz. (340 g) or approximately 501 yards (458 m).

**WEFT:** Same as warp, but natural grey. Amount needed: 8 oz. (227 g).

**SETT:** 8 epi (ends per inch) (30/10 cm).

**WIDTH IN THE REED:** 20" (50.3 cm).

**TOTAL NUMBER OF WARP ENDS:** 160.

**LENGTH OF THE WARP:** 3 yards (2.74 m).

**NUMBER OF PICKS PER INCH:** 7 ppi (28/10 cm).

**THREADING:** Slot, heddle, slot, heddle, repeat or shaft 1, shaft 2, shaft 1, shaft 2, repeat.

**WEAVE STRUCTURE:** Plain weave.

**SIZE OF THE FABRIC WHEN TAKEN OFF THE LOOM:** 18" (45.7 cm) wide, 88" (224 cm) long.

**SIZE OF THE FABRIC AFTER WASHING:** 12.5" (31.75 cm) wide and 57" (144.8 cm) long.



Tie the warp fringe temporarily with overhand knots so that the cloth does not unravel and wash the fabric in hot water with agitation.

### CONSTRUCTION OF THE BOOTS:

Enlarge the pattern pieces to the correct scale by redrawing the shapes on 4 per inch graph paper. See Fig. 1. Cut the felt exactly the same size as the pattern pieces. The front and side seams are whipped together with fine

strong thread, first on the wrong side and then once more on the right side. See Fig. 2.

Turn the boot inside out and machine stitch the sole to the bottom of the boot. Use  $\frac{1}{4}$ " (6.4 mm) seam. See Fig. 3. The sole may be thin leather instead of cloth. In this case the fabric sole is slipped inside the finished boot for extra cushioning. Decorate the boot with handmade trim and/or embroidery.

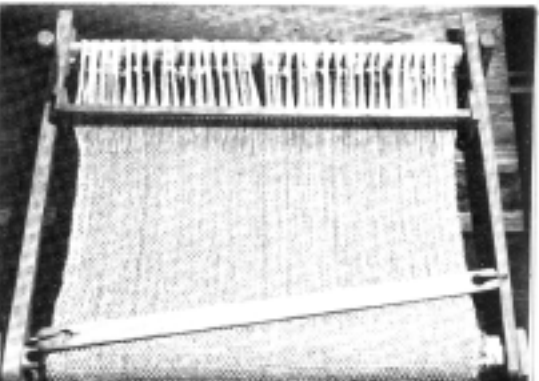
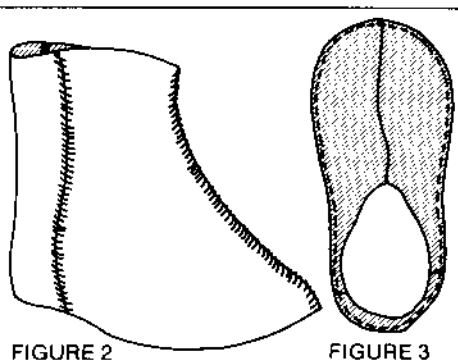
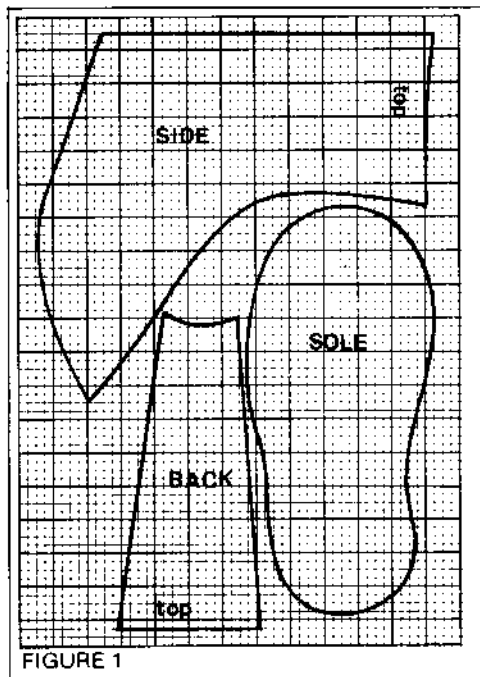

4-SHAFT TWILL

NECK SCARF

This scarf could very well be your first 4-shaft project. It is a good use of the twill weave structure and adds the challenge of using color both in warp and weft.

WARP: 2-ply wool in two colors (Beka Simpkin's 2-ply) Perendale wool in misty blue (X) and russet (O).

WEFT: Same as warp.

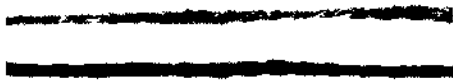

AMOUNT OF YARN NEEDED FOR THE PROJECT: 6 oz. (170 g) or 525 yards (480 m) of blue, 6 oz. (170 g) or 525 yards (480 m) russet.

COLOR ARRANGEMENT OF THE WARP: See Fig. 1.

								total
blue	4	12	7	12	4			39
russet	16	8	44	44	8	16		136
								175

TOTAL NUMBER OF WARP THREADS: 175.

LENGTH OF THE WARP: 3 yards (65" woven scarf, 12" fringe, 6" sample, 24" loom waste), 2.74 m (165 cm woven scarf, 30.5 cm fringe, 14 cm sample).

THREADING, TIE-UP, TREATING:

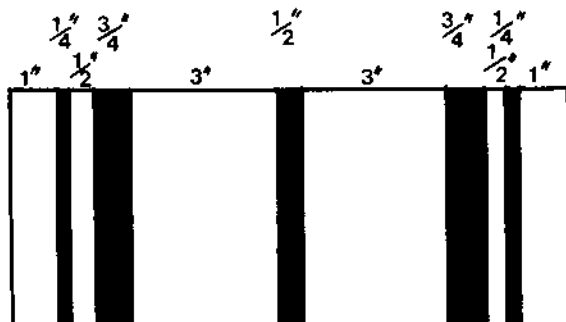
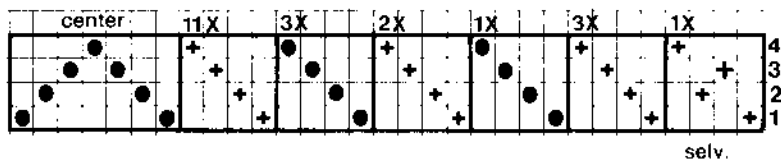

FIGURE 1.



SETT: 15 epi (60/10 cm), single sleyed in a 15 dent reed.

WIDTH IN THE REED: 11 1/2" (29.2 cm).

WEFT PLAN: See Fig. 2.

DIMENSIONS: When the scarf was taken off the loom it measured 11' X 63" (28 cm X 160 cm). The scarf was handwashed in lukewarm water. The finished dimensions are 10 7/8" X 61" (28 cm X 155 cm).

by Elizabeth Kolling-Summers

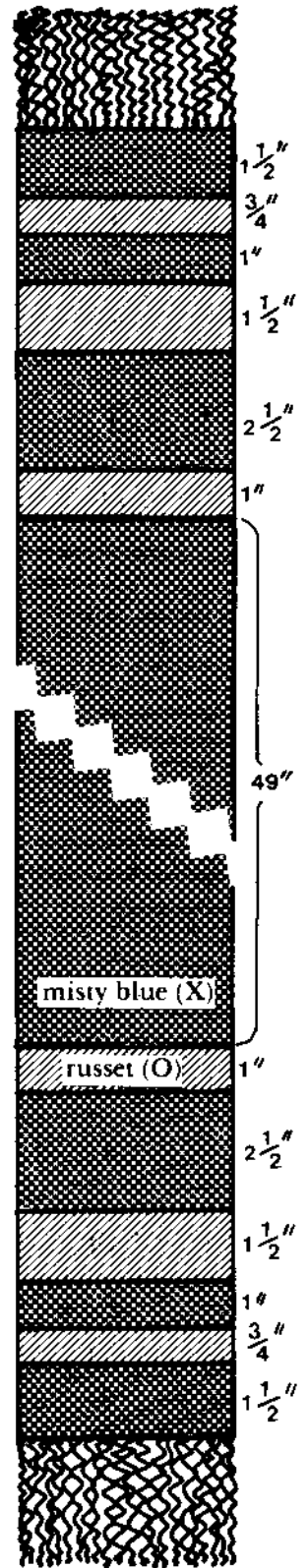

FIGURE 2



## WEAVING A CITY SKYLINE

by Ann K. Wennerstrom

When I first studied weaving at a small craft school in Sweden, I found that Swedish people have very close ties to nature. Many of the lovely, harmonious colors used in Swedish weaving are inspired by the natural environment. Our class used to go for walks in the woods, looking for pleasing color combinations in nature. We would then choose yarns to match the colors we had found and design our weaving projects with these yarns. I had a definite disadvantage in this design process, having spent my whole life in American cities! Try as I might, I could not come up with a design that the Swedes approved of.

"Your colors are too harsh. Why do you use such sharp contrasts?" groaned one of my Swedish friends.

"I *like* sharp contrasts," I said. "I think they're exciting! Besides, I grew up in Chicago where there are contrasts everywhere."

"What a shame you had to grow up in the city," she replied with compassion. "Cities are so ugly. No wonder your taste in color is a bit, well, different."

Secretly I was insulted. I've always loved the city, the strength of its buildings, the variety of its people, the rhythm of its life. Nature is in the city too, in the colors of a sunset or the eyes

of a child. To me the city's contrasts are beautiful.

I plotted my revenge. I decided to make a weaving which would show the beauty of the city. I envisioned a design of the Chicago skyline at sunset, the dark silhouettes of the buildings framed by soft pastels, one of the loveliest sights I've seen. I left Sweden with this plan still in mind, but no loom on which to carry it out!

Back in the United States I went to visit my parents who lived at that time in a retirement community. As it happened, this community had a craft shop which included a large weaving studio with several looms. There was a 20" table loom not in use and luckily I was given permission to use it. I took this opportunity to weave the Chicago skyline.

I had recently been working with the double weave pick-up technique and I realized that this technique might work especially well in a "city" weaving. Since the buildings of the city are geometrical, I could in most cases pick up straight horizontal lines across the weaving to achieve the rectangular shapes I wanted.

The first step was to draw my cityscape on a piece of graph paper. I wasn't interested in an exact replica of the Chicago skyline; I only wanted to represent a few of my favorite buildings. I drew some rough sketches of skylines until I had one I really liked. Then I blocked out the chosen sketch in detail so that each square of graph paper represented two warp threads crossed by two weft threads.

Next I planned my fabric. Since the double weave technique is worked in two layers, I tried to think of each layer as a distinct piece of fabric. I wanted the top layer to look like a sky at sunset, and the bottom layer to be the dark color of concrete buildings. I would then be able to switch the layers at any point, bringing the dark layer to the surface of the wall hanging to form the buildings.

Finding the yarn I wanted was a problem at first. The only yarn store I could find in the area was a knit and crochet shop! In the long run this turned out for the best because I was now forced to consider a yarn that I had never used in weaving before: crochet cotton! It was strong, durable, and came in a wide variety of colors. I had originally



hoped to find a medium weight wool, but the cotton gave me a much finer weave, allowing for a more detailed design.

For my bottom layer, which would form the buildings, I chose black and dark brown. I decided to combine them in a random stripe pattern in both warp and weft to achieve a plaid effect. I thought that a subtle plaid in the actual fabric would echo the geometrical shapes of the buildings, adding a certain depth to the wall hanging.

For my top layer (the sunset) I chose four colors: white, yellow, pale orange, and a variegated yarn with several shades of pink, blue, purple, green, and yellow. This variegated yarn was ideal for a sunset design because the yarn changed color every four or five inches, giving a streaked effect to the sky.

By observing a real sunset, I learned that the brightest, most yellow part of the sky is just above the horizon at the point where the sun has gone down. Farther up or out to the sides, the sky

appears darker and bluer. Therefore, I arranged my sunset-colored yarns in wide bands with the brightest colors at the center of the horizon and the darker colors out toward the edges. Because I used these bands of color in both warp and weft, another subtle plaid resulted wherever the bands of color crossed.

I decided to weave the design sideways so that the left-hand selvedge became the bottom of the piece when it was hung properly. This decision allowed me the turn each building on its side and weave it weft-wise along its length.

I made each warp separately, threading the sunset layer on shafts one and three, and the building layer on two and four. Both layers are woven in tabby. I used a 15 dent (60/10 cm) reed with two ends per dent (one end from

**NOTE:** I have chosen not to explain the actual technique of double weave pick-up. However, a good explanation of it exists in several sources including Elsa Regensteiner, *The Art of Weaving* (New York: Van Nostrand Reinhold, 1970), Chapter VI.

each of the two warps). Using a pick-up stick, I carried out the design according to my graph. In many ways the actual weaving was the easiest part after the elaborate preparation I had already done.

The finishing touches included a hem on each end of the piece and a hanging device: a dowel, wrapped with the same variegated yarn used in the sunset. As I wrapped the yarn around the dowel, I sewed it through the top of the wall hanging, inserting one stitch after every fourth or fifth warp. The effect of this was a continuation of the sunset right onto the dowel.

When I looked at the finished project, I felt that I had accomplished my goal of proving to myself, the Swedes, and anyone else who might be interested that the city can be beautiful! Those of you who have been to Chicago may recognize the John Hancock Building, the Prudential Building, the Museum of Science and Industry, the Standard Oil Building, and the Wrigley Building with its clock set at a quarter to six, sunset time.

## SLING BRAIDING OF THE ANDES



ADELE CAHLANDER

WITH ELAYNE ZORN AND ANN POLLARD ROWE

Weaver's Journal Monograph IV

## SLING BRAIDING OF THE ANDES

by Adele Cahlander

with Elayne Zorn & Ann Pollard Rowe

ISBN 0-937452-03-3

Library of Congress Catalog #80-67114

Illustrated with Color  
and Black/White Photographs and  
with Line Drawings

Published by  
**Colorado Fiber Center, Inc.**

With the help of a grant  
from the National Endowment for the Arts

### ABOUT THE BOOK

Slings have been used since before the time of David and Goliath. Shepherds used slings to guide their sheep and to protect the sheep from marauding animals. In the Andes, slings took on ceremonial importance as well. Through the years, they were developed into works of art.

How the intricate braids were actually made has long been a mystery. This monograph is the first true documentation on the way the slings were constructed. During field work among the remote highland herders, Elayne Zorn learned the basic techniques on which this book is based. Through the close cooperation of Ann Pollard Rowe and Irene Emery of the Textile Museum in Washington, D.C., a suitable terminology was provided.

**Price: \$11.00 Postpaid**

Please make checks or money orders, in U.S. funds, payable to: *The Weaver's Journal*, P.O. Box 2049, Boulder, Colorado 80306 (U.S.A.)

Outside U.S.A. -Add \$1.50

**Air Mail:**

Canada & Mexico -Add \$4.00

All others -Add \$6.00

NAME \_\_\_\_\_

ADDRESS \_\_\_\_\_

City

State or Country

Zip

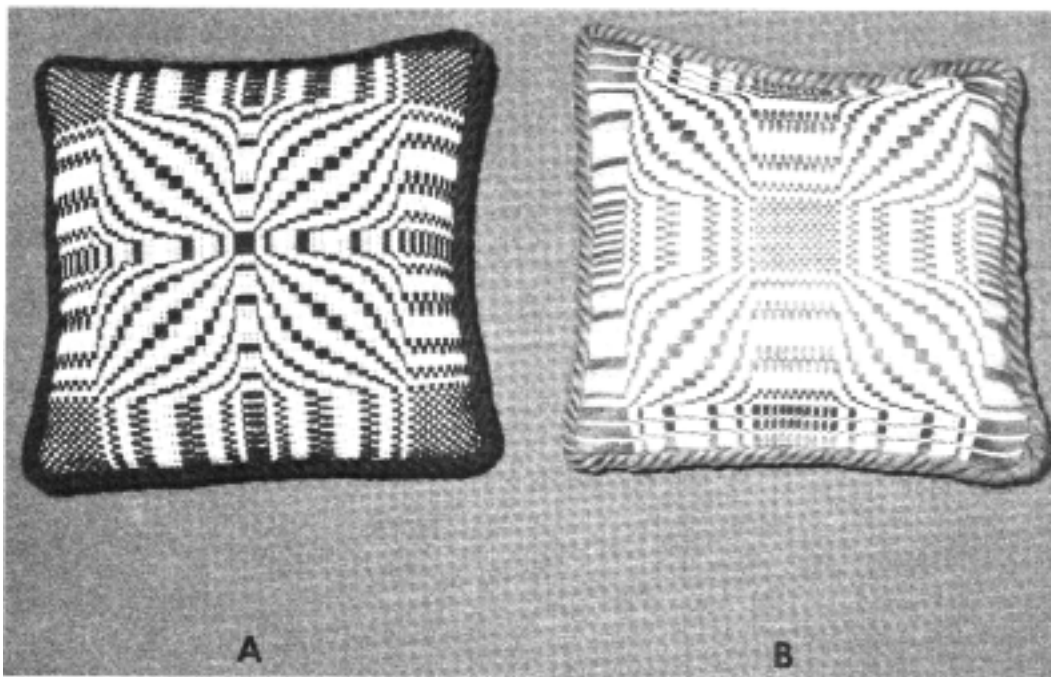

Photo 1

## DIFFERENT BUT RELATED

The use of an overshot design for the front of a pillow has always intrigued this weaver. However, what is more dull than a traditional overshot-woven front of a pillow with the back just plain cotton tabby weave or with the back the same as the front? Surely there must be another way. There is, if one wants to play around with the threading draft and then do complicated drawdowns to study the effects.

The two photographs (Photo 1 and Photo 2) show two such results; the two pillows are based on the same theme but each side of each pillow is different but related. Pillow 1-A is the front of the pillow shown in 2-A (the back); 1-B and 2-B are similarly related.

Both initial pillow fronts are adaptations of Marguerite Davison's Blooming Leaf of Mexico, Weaver Rose No 36-A from Davison's *A Handweaver's*

*Pattern Book*, p. 162. Pillow 1-A is a partial use of the original layout of the Blooming Leaf of Mexico pattern. Pillow 1-B is a further adaptation, taking the flower center of 1-A, enlarging 1-A's center and adding tie-downs to prevent long overshot floats. This adapted "center" then becomes the border for pillow 1-B. The corner of pillow 1-A then becomes the center for 1-B. The above discussion is presented only to show how the two pillows in the photographs are companion pieces; it has no bearing on the topic presented in this article, "Different BUT Related" sides of each pillow.

Both companion pillow backs are different from the fronts (Photo 2)—"Related BUT Different". The threading draft of each pillow back is made by making a carboned mirror image of its threading draft (front of pillow),

then turning the draft 180° so that shaft 1 becomes shaft 4, 2 becomes 3, 3 becomes 2, and 4 becomes 1.

The front and back of each photographed pillow were woven side by side (a total of 760 warp ends sett at 30 epi (120/10 cm). Belding Lily 20/2 cotton was used for the warp and tabby weft; Cum 20/2 100% wool worsted, doubled, was used for the pattern weft. Both pillows had their own separate 760-thread threading draft.

No attempt will be made in this article to show the complicated threading drafts of these companion pillows. Instead, a simple overshot design will be used and manipulated to show how "Different BUT Related" works.

A simple overshot draft, based on the point twill threading of Fig. 1 will be used for this discussion.

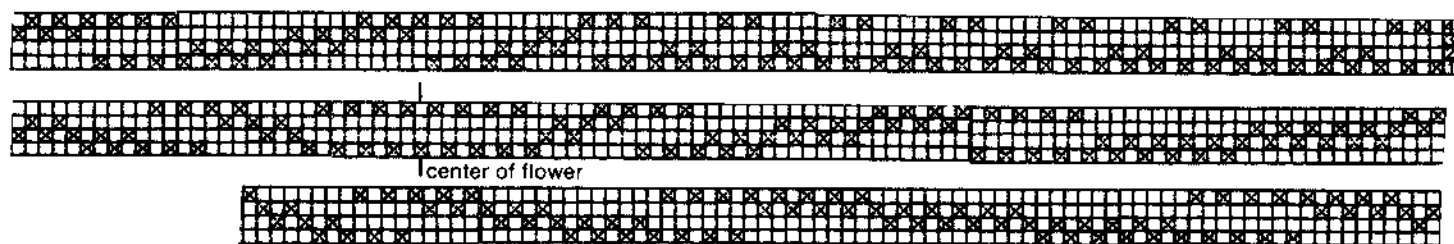

Threading of Blooming Leaf of Mexico

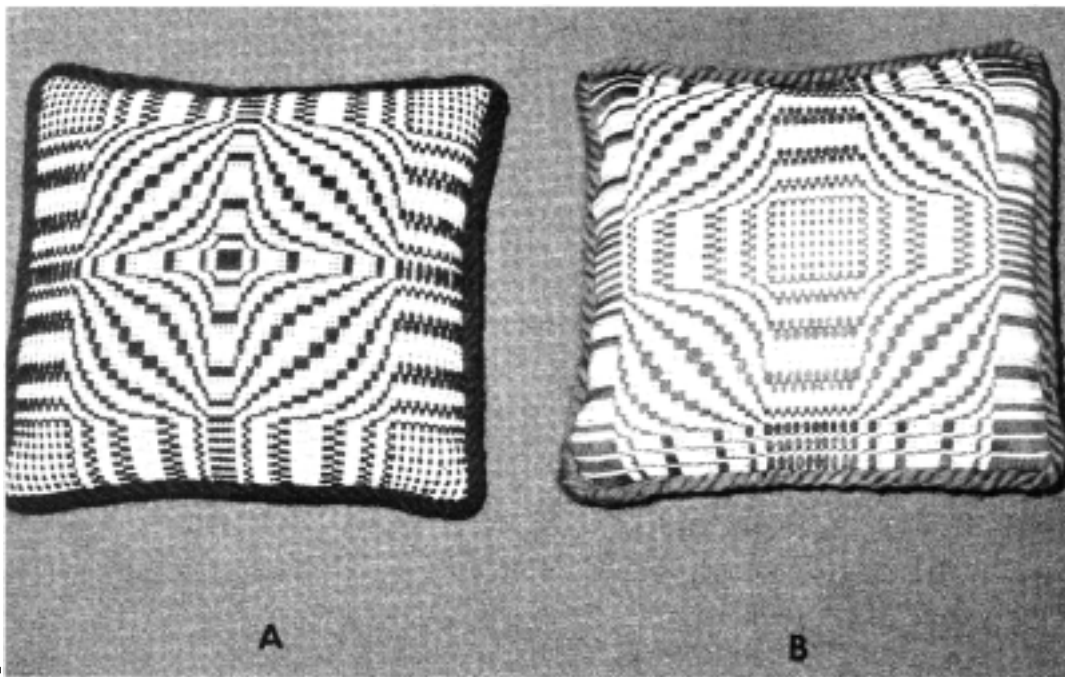

Photo 2

by Dorothy N. Smith

To derive the overshot threading the warp thread on shaft number 1 must be converted to the basic overshot block on shafts numbered 1 and 2. Likewise with the rest. (Fig. 2)

The basic overshot threading draft will be expanded to the following overshot draft based on a point twill threading. (Fig. 3)

The mirror image of the above draft is made by placing the carbon paper in upside down (wrong side up) under the threading draft paper and marking the draft down, resulting in the paper being marked on both sides. Actually, it is easier to use two separate sheets of paper and place the carbon paper wrong side up under the bottom paper. Then take the "errored" carbon copy and turn the draft 180° (turn upside down). Then the carboned-mirror-turned image of 1 becomes 4, 2 becomes 3, 3 becomes 2, and 4 becomes 1. (Fig. 4)

Now one has a "Different BUT Related" threading draft for the pillow back. The total threading draft, front and back, are placed side by side. (Fig. 5)

The threading draft (Fig. 5) is treadled as drawn in for the original overshot draft. Since the "pillow back" is threaded right alongside the "pillow

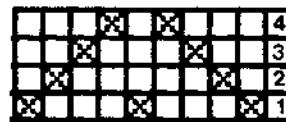

FIGURE 1

Twill threads on shaft:	1	Converted to basic	1 and 2
	2	overshot block on	2 and 3
	3	shafts:	3 and 4
	4		4 and 1

FIGURE 2

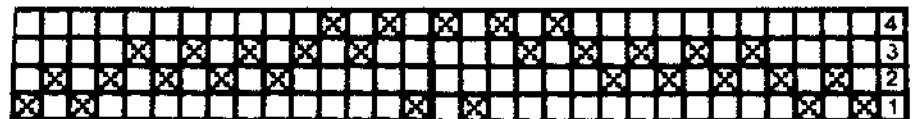

FIGURE 3

Shaft	1	Rewritten	4
	2	as	3
	3		2
	4		1

FIGURE 4



Different BUT Related to the overshot draft

Overshot draft based on a point twill

FIGURE 5

front," the aforementioned treadling also weaves the back of the pillow which is thus not on its own drawn-in schedule. If by chance the weaver insists on threading only the pillow front and weaving it off and then rethreading the shafts with the "Different BUT Related" back, the weaver must treadle the second threading identical to the first. If the second threading is treadled as it is drawn in, the resulting design on the back will be identical to the front of the pillow. By threading both drafts side by side, this possibility is eliminated.

Now one has a threading draft for the total pillow. If the outcome of the

design is questioned, do a complete drawdown of the entire threading in order to visualize the resulting fabric. (Fig. 6)

In this way a traditional woven overshoot pillow may be made more intriguing by weaving the back as a "Related BUT Different" design. This is accomplished by making a mirror image of the original threading draft and turning it 180°, thus interchanging the shafts. Since the actual draft threading design is not scrambled, the resulting draft design is related to the original and makes for an intriguing front-and-back pillow relationship.

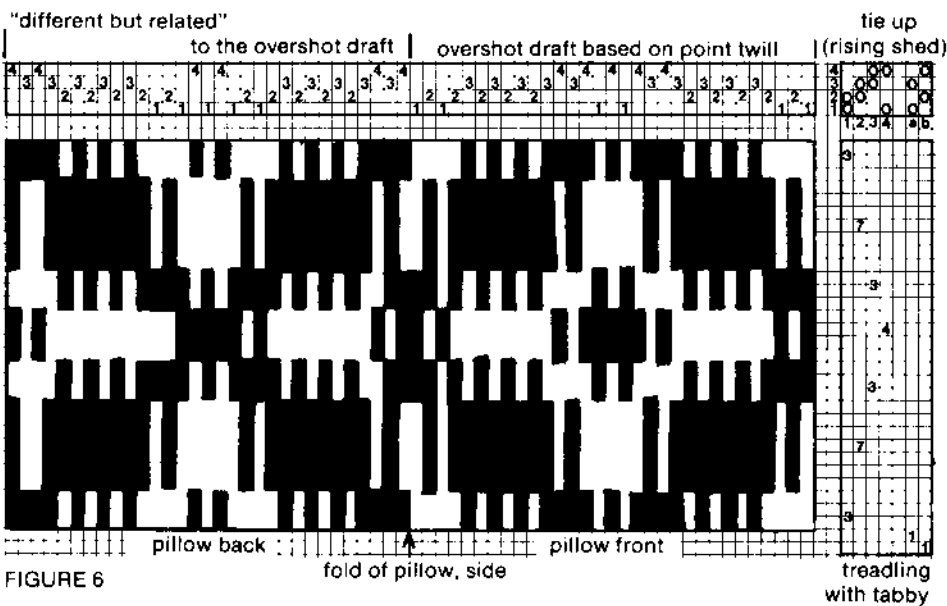

FIGURE 6

# DOUBLE WOVEN MAILBAG WITH NAMETAGS

by Lieve Verlinden

The mailbag shown in Photo 1 is one of the most useful things I have ever woven. Each member of the family has a pocket with his/her name on it in which to put letters and other small things that otherwise get lost. The top pocket has no name. In there we put invoices and bills to be paid.

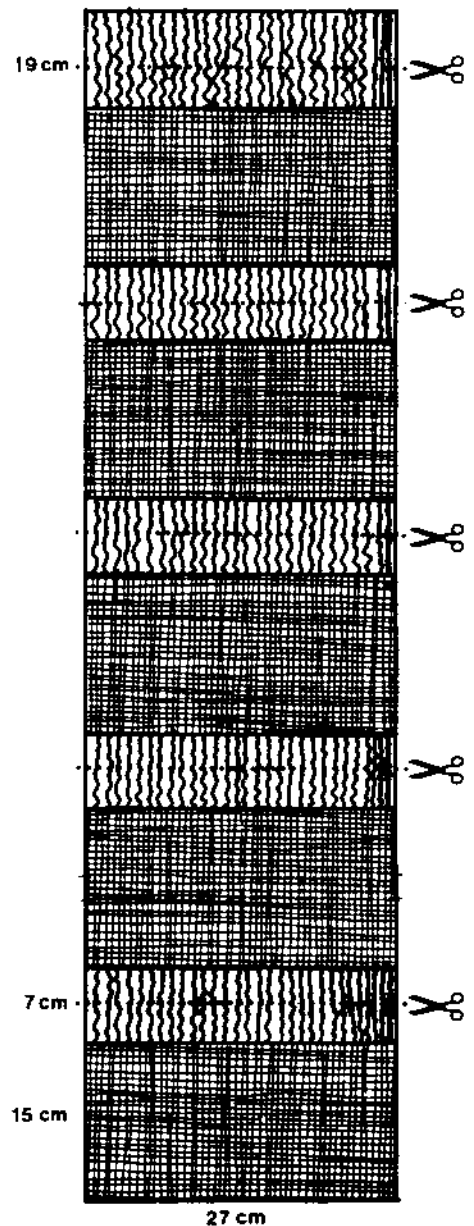
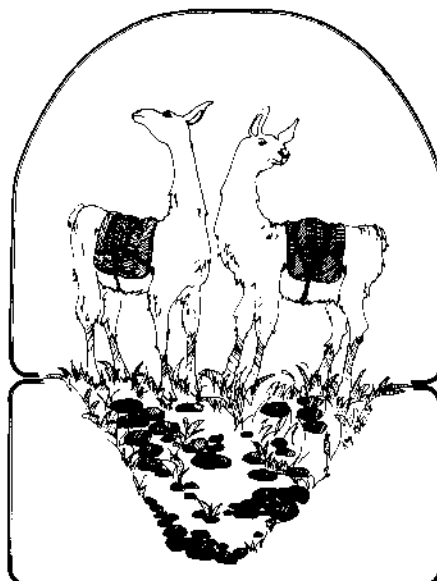

FIGURE 1



Notecards from Colorado Fiber Center. For information, write P.O. Box 2049, Boulder, CO 80306



For the first row of the pattern of Fig. 4, pick the left 2 pattern ends. Turn the stick so that it stands on one edge and

transfer this shed to another stick in front of heddle A. This is made easy by moving heddle A up and down.

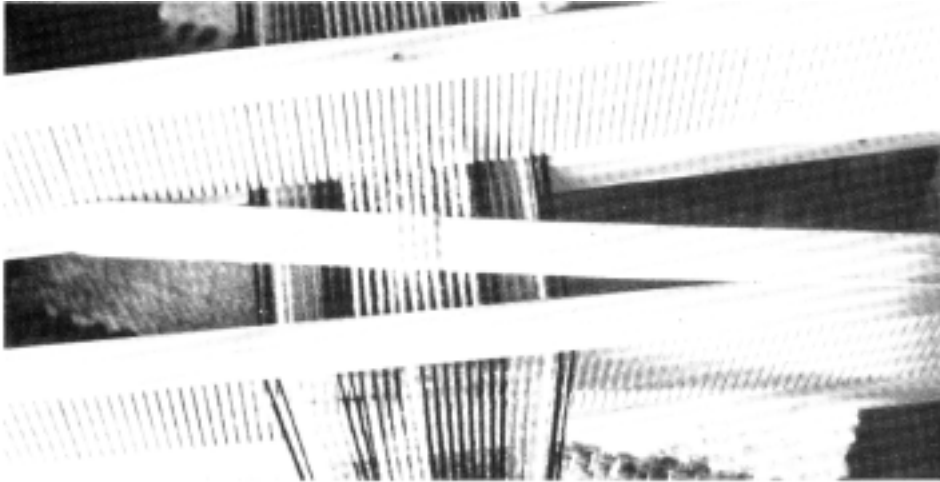

Photo 2



Photo 3



Photo 4

Remove the first pick-up stick. For the first weft pick of the pattern area put heddle B in the DOWN position and heddle A UP. See photos 3 and 4. Insert a shed stick below the pick-up stick and move the shed stick horizontally toward the cloth beam to clean the shed. Turn the stick on its edge to form a shed for the shuttle which passes from right to left. Beat with the shed stick after changing the shed.

For the second pick of the pattern area, re-pick the pattern threads if necessary (see Fig. 4); repeat the first step but with heddle A DOWN.

One can weave many patterns but the pattern threads should not float over more than 3, 4 or 5 weft picks.

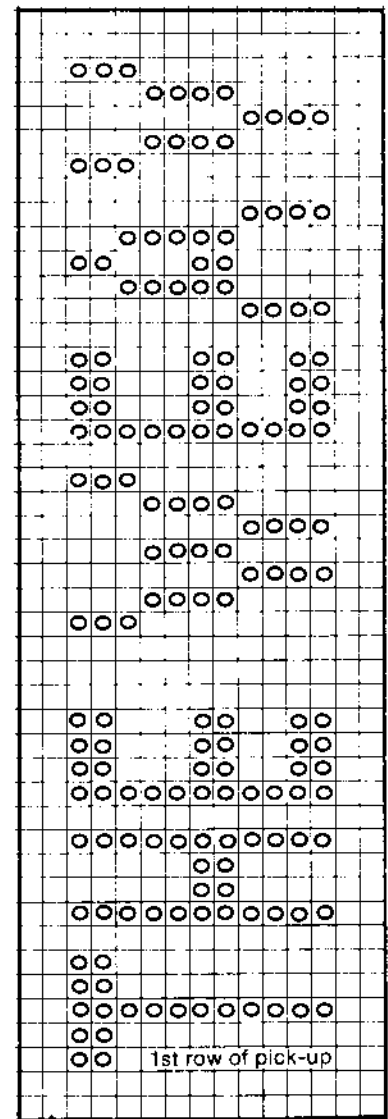
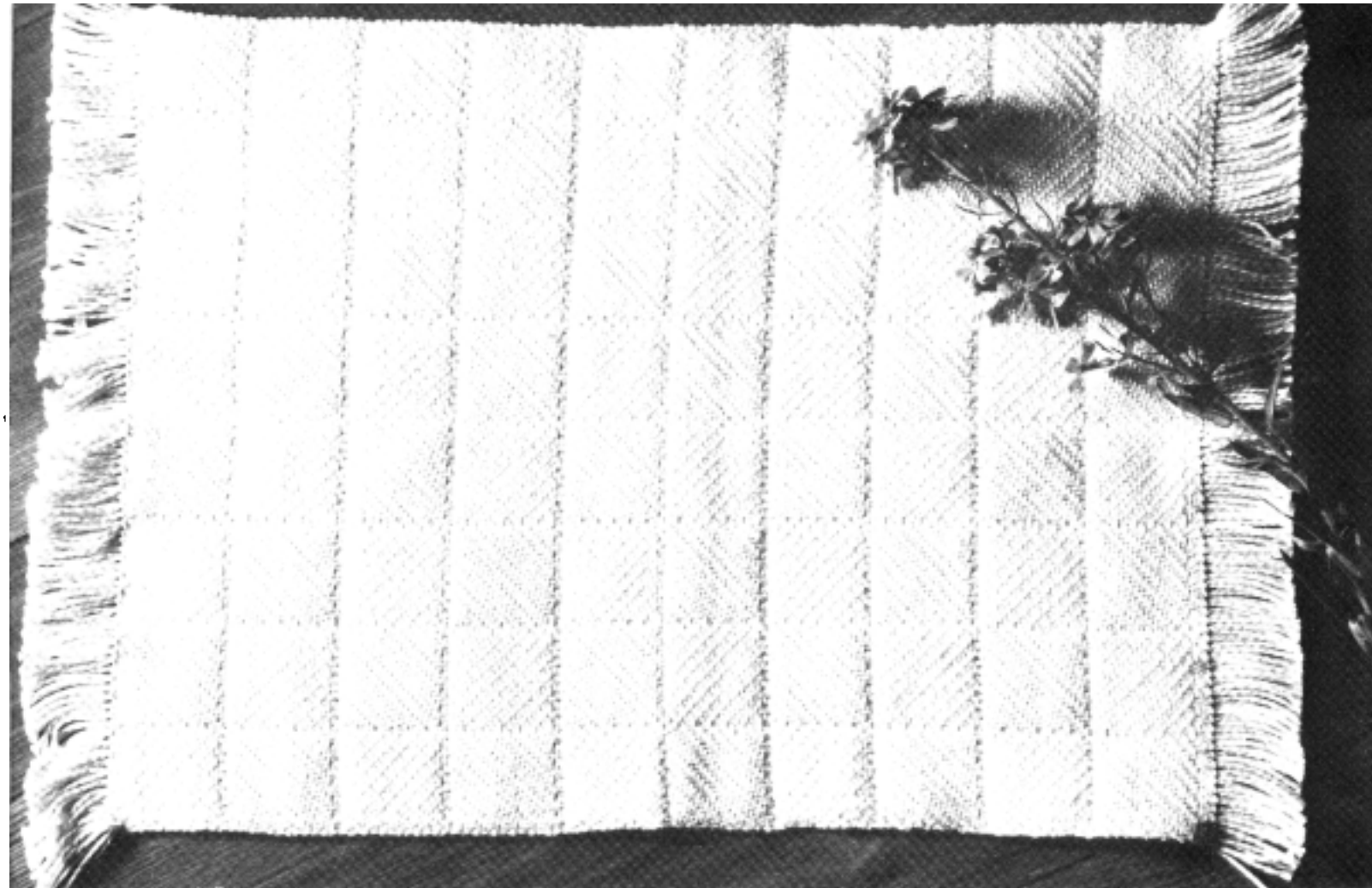

FIGURE 4

Lieve Verlinden-Hendricks lives with her husband and two teenage daughters in Hombeek, a small village between Brussels and Antwerp in Belgium. She began spinning fourteen year ago, and dyed some of the yarn with vegetable dyes. A birthday gift of a loom started her interest in

weaving, which she has learned from books, with practice at the loom. She now uses a Glimakra Standard loom and a 4-shaft loom her husband made for her. Her weaving project last year was a large living room rug, made in three panels. The rug is 4.75 m x 2.70 m or 15.67 ft x

8.91 ft. It is done in Navajo style using handspun natural grays. For the last 8 years, Lieve has taught workshops on spinning and vegetable dyeing.



*Photo 2. Placemat by Linda Kelly.*

## STITCHED DOUBLE CLOTH—MATELASSE

Stitched double cloth would be classified under the general heading of double weave. The technique of double weave is used for many textiles. The handweaver uses it for folded cloth when he wants to weave fabric twice as wide as the width of the loom, to produce tubular goods and to create pattern blocks which are often enhanced by warp and weft color effects. In the textile industry double weave is most often used to increase the weight, thickness and warmth of a fabric. Regular stitched double cloth has two layers which are frequently stitched together by interlacing threads of one layer with threads of the other. By carefully selecting the yarns and textures of both layers, the stitched double cloth is a reversible fabric that has many uses in fashion design. The man's vest featured on p. 38 of this issue is an example of the use of 4-shaft stitched double cloth fabric.

In stitched double cloth the stitches

should be as scattered and as unobtrusive as possible. A 4-shaft loom is very minimal for this technique. The stitches can be made much less visible if more shafts are available.

Matelasse is a type of stitched cloth which has more of a quilted look. The stitches which tie the two layers together form a well defined pattern. Matelasse fabric is often stuffed to emphasize the design made by the stitches and to give additional warmth and thickness to the fabric. The stuffer yarn lies between the two layers of cloth. The stitching can be done by the pick-up method, may be loom controlled or, as described in the article by Kathy Bardwell, can be done with floating warps. The sample shown in Photo 1 is an example of matelasse by means of pick-up on a 4-shaft loom. The technique is described on p. 40. The jacket featured on p. 41 is an example of loom-controlled matelasse using 8 shafts. The baby blanket

shown on p. 39 introduces an easy way to weave matelasse on 4 shafts by means of floating warps.

Linda Kelly, who contributed the placemat shown in Photo 2, thinks of matelasse as an extension of corded weaves. In her matelasse wallhangings she emphasizes the puffiness of matelasse by increasing the tension of the warp and weft of the lower layer. In the following pages Linda Kelly explains the drafting of matelasse.

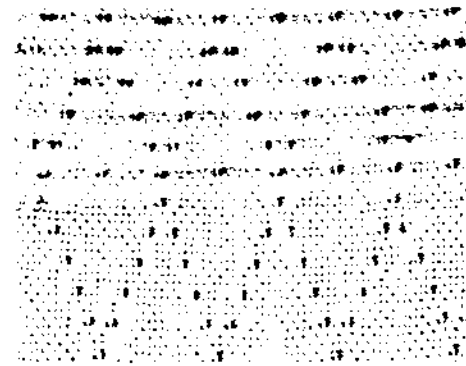

*Photo 1. Pick-up matelasse.*



The 3/2.5 alpaca yarn which Silk City Fibers imports from Peru is a soft and lofty yarn which would lose some of its character if it were woven with too close a sett. A plain weave with 5 epi and 5 ppi (20/10 cm) seemed like an ideal weave structure. Yet alpaca is slippery, and if the fabric was to be cut and sewn into a vest the fabric needed a denser backing for ease of sewing and for added body. The vest was thus woven in a 4-shaft stitched double cloth also called backed cloth.

**FACE:** 3/2.5 alpaca (51 yards or 46.6 m per 1.75 oz. (50 g) ball) from Silk City Fibers (●).

**BACKING:** 3/20 worsted wool (Nehalem from Oregon Worsted Co.) (X).



**SETT:** 5 alpaca and 15 wool ends per inch (20/10 cm and 60/10 cm).

**SLEY:** In a 5 dent (20/10 cm) reed: 3 wool ends and one alpaca end per dent.

**THREADING, TIE-UP AND TREADING:**

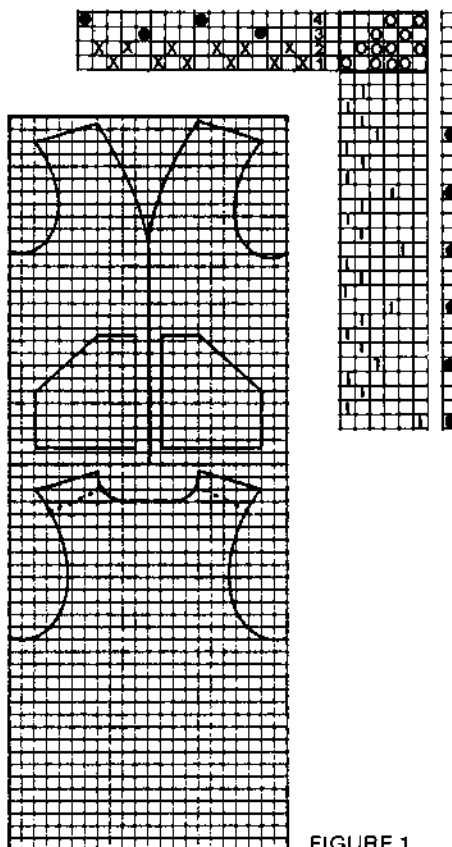

FIGURE 1.

**LENGTH OF THE WARP:** 3 yards (2.75 m).

**WIDTH IN THE REED:** 24" (60 cm).

**TOTAL AMOUNT OF YARN NEEDED:** 14 balls of alpaca (1.75 oz. or 50 g each); 7-2 oz. (57 g) spools of wool.

Note that the fabric is woven wrong (wool) side up. This weave structure can also be regarded as a simple matelasse. In this case, the tighter woven surface (wool side) would be considered the right side of the fabric. The insertion of a stuffer weft between the two layers would accentuate the corded look of this fabric.

**SIZE OFF THE LOOM:** 23" X 74" (58 X 188 cm).

**FINISHING:** As the wool of the backing shrinks more in water than the alpaca of the face, it is recommended to dry clean this fabric. We washed ours and this was successful too!

**FINISHED SIZE:** 22" X 72" (56 X 183 cm).

**PATTERN:** See Fig. 1

**SEWING INSTRUCTIONS:** All the raw edges were bound with ultra suede. The seams were sewn with the wrong sides together, pressed open and covered on the right side with a strip of ultra suede.



# LOOM CONTROLLED QUILTED FABRICS

by Kathryn  
Bardwell



Quilted fabrics are in vogue. They are seen on the ski slopes as down vests and parkas. They are seen in the home as colorful bed coverings and wall hangings. And they are seen just as frequently in the high fashion centers on models displaying elegant coats, jackets and evening skirts. We weavers are eager to design and create similar fabrics.

One limiting factor has been the laborious and slow hand-pickup technique necessary to weave a double-layered quilted fabric on a four shaft loom, the loom most often owned by handweavers. For ordinarily on this loom, when the weaver desires to quilt or stitch the two layers together, a pickup stick is needed to raise the quilting warps from the lower to the top layer.

This article will describe a method of loom controlled quilting on a four shaft loom, a method which creates an additional fifth shaft. Thus speed can become an integral part of the weaving process. The technique became obvious to me while reading about Spot Bronson in an article by Carol Thilenius entitled "A Five Harness Pattern on a Four Harness Loom", *Interweave*, Summer, 1979. The author creates a fifth shaft on a four shaft jack type loom by means of floating warps which are threaded from the back beam, through the reed and then tied to the front beam. Not going through a heddle, these floating warps remain stationary in the center of the shed. They are incorporated into the woven structure when interlaced with the

weft thread which passes over or under the floating warps depending on whether the fifth shaft is to be up or down. The method is similar to that of using a floating warp as an outside selvedge. This floating selvedge is woven into the fabric by passing the shuttle over the warp when entering the shed and under the warp when leaving the shed.

The traditional threading for a double-woven two-layered fabric on a four shaft loom is a straight twill 1,2,3,4 threading with the A layer woven on shafts 1 and 3 and the B layer woven on shafts 2 and 4.

TIE-UP AND TREADLING FOR THE A LAYER TO BE ON TOP:

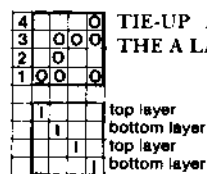

TIE-UP AND TREADLING FOR THE B LAYER TO BE ON TOP:

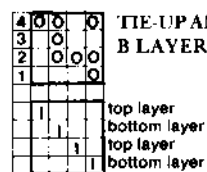

In a quilted fabric, the number of warp ends to be used in stitching the two layers together depends on the quilted design to be developed. (It should be noted that all the quilting warps need not necessarily be used at the same time to stitch the two layers together). These quilting warps will be floating warps. They will be warps which ordinarily would have been threaded on shaft 4. Where there is a floating warp end

shaft 4 will be skipped and the thread will come directly from the back beam, through the reed to the front beam. At this point, the threading sequence will be 1,2,3, floating warp, 1,2,3,4, etc. These floating warps should be woven as if on shaft 4 except when the two layers are to be quilted together. Then in addition, they should be woven as if on shaft 1 as well. When the A layer is on the top, the A and B layers are stitched together by bringing to the upper layer the floating warp which ordinarily would weave on the lower layer. When the B layer is woven on the top, the layers are stitched together by depressing the floating warps from the upper layer to the bottom.

TIE-UP AND TREADLING WITH THE A LAYER ON TOP, NO QUILTING

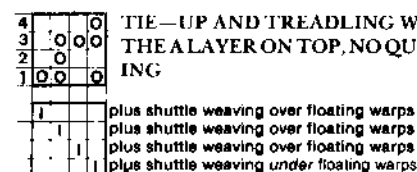

TIE-UP AND TREADLING WITH THE A LAYER ON TOP, QUILTING

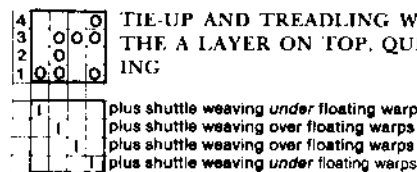

TIE-UP AND TREADLING WITH THE B LAYER ON TOP, NO QUILTING

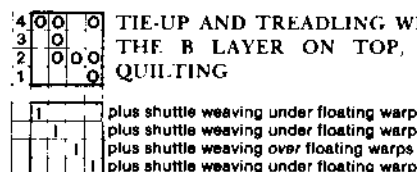

TIE-UP AND TREADLING WITH THE B LAYER ON TOP, QUILTING

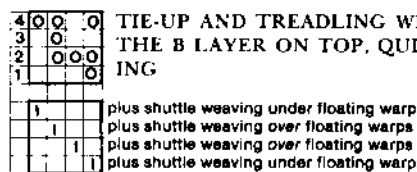

The baby blanket has four floating warps across the width of the structure. The two layers were quilted together every first of four picks. The sections were stuffed with synthetic batting prior to the exchange of blocks from the lower to the upper level. It should be pointed out that all directions are for a jack-type, four shaft loom. Stick shuttles are more easily manipulated than boat shuttles.

Once this technique has been mastered, the design possibilities begin unfolding. Many exciting quilted textiles will be conceived and woven.

### QUILTED BABY BLANKET

WARP: 22/2 cottolin in 4 colors

WEFT: Same as warp

COLOR ARRANGEMENT IN THE WARP:

red			102		102
orange			102	102	
purple	102	102		102	102
pink	102	102			
	alternate colors	alternate colors	alternate colors	alternate colors	alternate colors

opposite color order

SETT: 36 epi (140/10 cm) (4 per dent in a 9 dent reed)

WIDTH IN THE REED: 28½" (73.3 cm)

COLOR ORDER OF THE WEFT:  
purple—repeat for two treading blocks  
red—repeat for two treading blocks  
orange—one treading block

The blocks should be sealed at the beginning and end of the blanket by weaving two or more picks of plain weave.

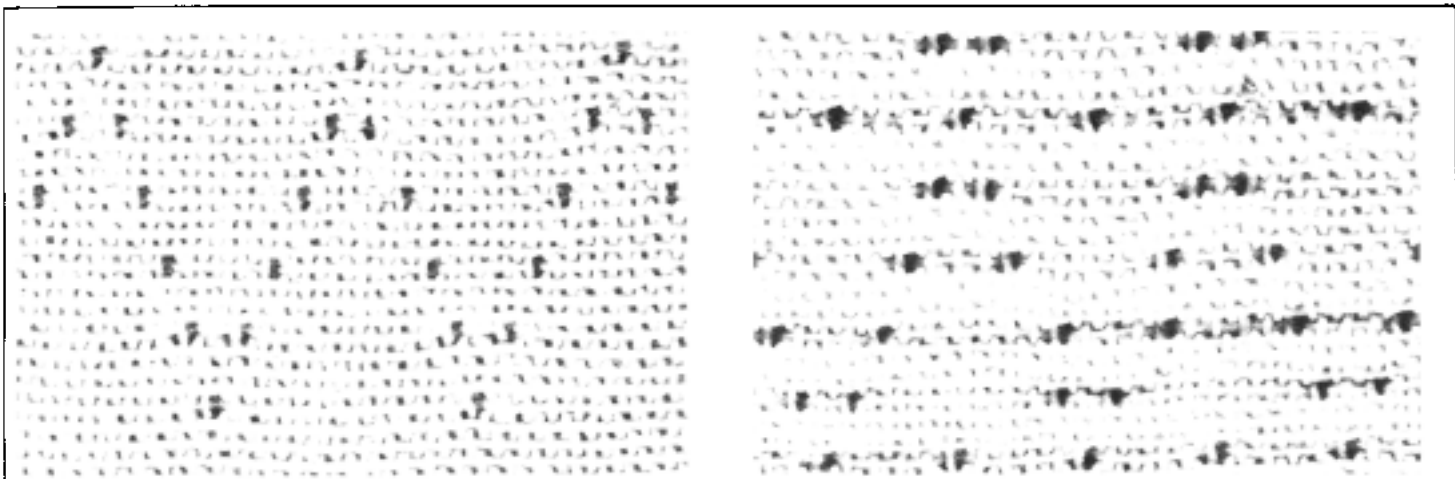

### SIMPLE MATELASSE BY THE PICK-UP METHOD

For simple matelasse by the pick-up method a 4-shaft loom is set up for double cloth with a light layer on top and a dark layer at the bottom. To practice it is best to set up a small sampler big enough to weave a series of potholders.

WARP: 5/2 perle cotton or carpet warp in two colors light (X) and dark (O).

WEFT: Same as warp.

WIDTH IN THE REED: 10" (25 cm)

SETT AND SLEY: 15 dark + 15 light per inch, sleyed 1 dark + 1 light per dent in a 15 dent (60/10 cm) reed.

THREADING:

		O	X	4
X			X	3
	O			2
		X	X	1

DESIGN: For a sampler with 150 dark ends and 150 light ends draw the outline of a design on 75 squares of graph paper. See Fig. 1. Each ■ represents a stitcher. Make sure that the selvedge edges are stitched frequently.

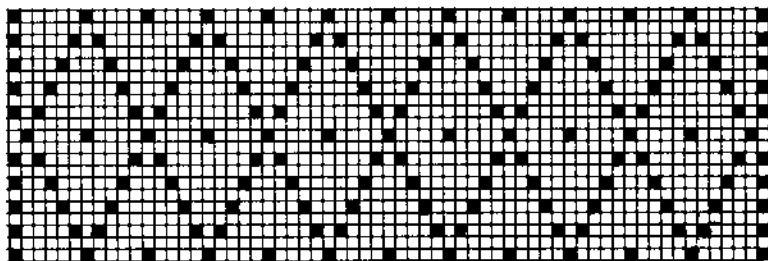

FIGURE 1

When no stitch appears on a row of graph paper weave as follows:

- Lift 1      weave X
- Lift 1,2,3      weave O
- Lift 3      weave X
- Lift 1,3,4      weave O

When a stitch appears on the row of graph paper:

- Lift 2 with a pick-up stick, pick one end for each marked square of graph paper. 75 ends are up and there are 75 squares; pick only the ones marked. Let 2 down and put pick-up stick close to the reed. Lift 1, weave X (under the pick-up stick). Remove pick-up stick.

- Lift 1,2,3      weave O
- Lift 3      weave X
- Lift 1,3,4      weave O

If a stuffer pick is needed, insert it with 1 + 3 up *before* weaving a stitching sequence.

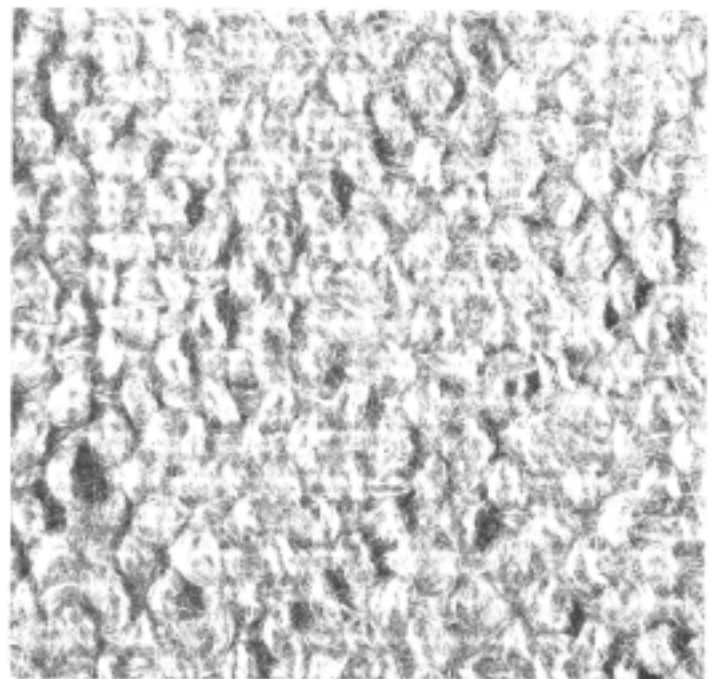
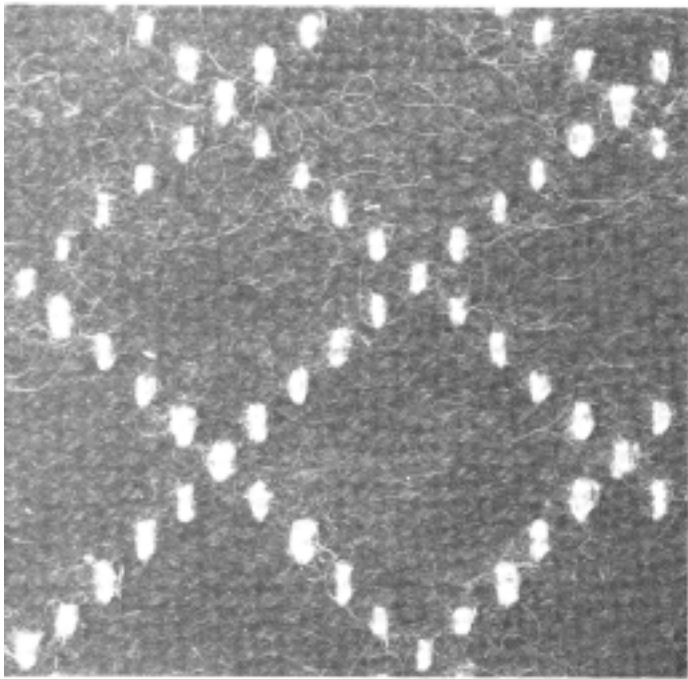

# REVERSIBLE MATELASSE JACKET

by Ellen Champion

The loom controlled matelasse cloth for this jacket was designed to make a warm, soft, completely reversible fabric for an unlined garment. Both sides complement each other for the body and for the trim of the jacket.

## WARP AND WEFT:

**Face:** 2/6.5 wool (Borgs S.N.2 garn) in two colors: brown (#63), red (#59).

**Back:** synthetic mohair (Sumatra from Grandor Industries Ltd. which is 67% acrylic and 33% nylon). color: mink.

Note: the manufacturer of Sumatra suggests machine or handwashing this fiber and not dry cleaning. *The Weaver's Journal* has used both washing and dry cleaning with excellent results.

## COLOR ORDER OF THE FACE WARP:

	total			
brown	2	5	2	9 per repeat
red	5	3	3	11 per repeat
repeat				

## COLOR ORDER OF THE FACE WEFT:

	total			
brown	2	2	6	10 per repeat
red	2	6	2	10 per repeat
repeat				

WIDTH IN THE REED: 41" (109 cm).

**SETT:** 8 face ends and 4 back ends per inch. (30 and 15/10 cm)

**SLEY:** In an 8-dent reed sley: 1 face, 1 face + 1 back, 1 face, 1 face + 1 back, etc.



## THREADING, TIE-UP AND TREADLING:

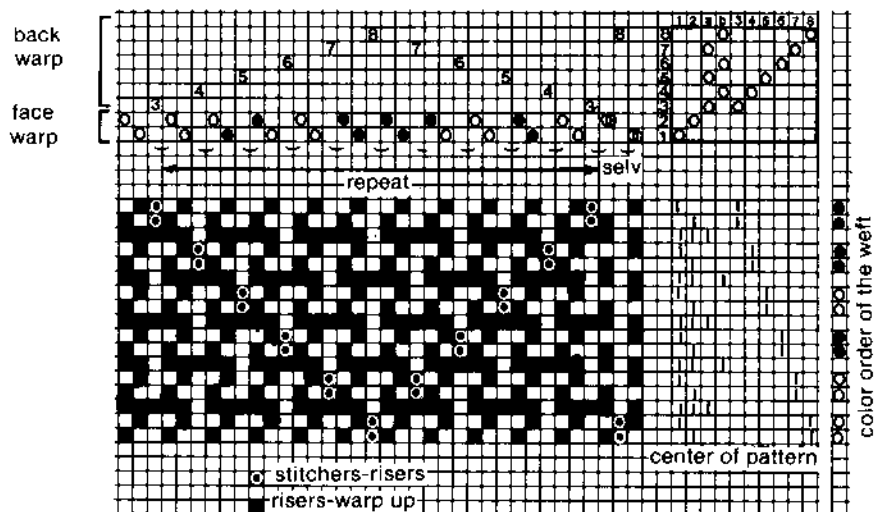

**SELVEDGE:** See threading. Double the first and last two face ends in the heddle and in the reed.

The two layers of the stitched fabric are plain weave. Selected back warp threads are raised as stitching risers into the face of the fabric and are kept up for two consecutive picks of the face cloth. This makes the stitch longer and more visible on the face of the fabric. The threading of the back cloth is a point twill which allows the backing to be woven in plain weave and at the same time allows the stitching risers to be arranged in point twill order and thus produce diamond patterns.



*Reversible matelasse jacket woven by Ellen Champion*

The mohair causes the sheds to stick. When the back cloth is woven, first lift shafts 1 and 2 with one foot and then lift either 3+5+7 or 4+6+8.

**SIZE OFF LOOM:** 38" (96.5 cm) wide, 173" (4.39 m) long

**FINISHED SIZE:** 37" (94 cm) wide, 165" (4.2 m) long

**PATTERN:** Simplicity #9836—jiffy unlined topper



# MATELASSE DOUBLE CLOTH STITCHED TO FORM THE DESIGN

Matelasse is stitched double cloth in which the stitching makes visible patterns. Matelasse is related to the class of double weaves.

In double weave two layers of cloth are woven simultaneously. In matelasse the two single layers of fabric are combined at various points where the warp of one layer interweaves with the weft of the other. The way this stitching or binding is achieved can influence both the appearance and feel of the cloth. The more the layers are stitched together the firmer the fabric will feel; the less frequently they are stitched the softer or looser it will feel. The stitching is also planned as a motif for a design.

In matelasse two single layers, each having its own system of warp and weft, are woven simultaneously, the same as other double weaves. The face cloth is usually a twill, basket, or similar weave (or combination thereof) with the back woven in plain weave. The warp is generally set 2 face, 1 back with the weft woven the same or 2 face, 1 stuffing, 1 back pick.

The embossed appearance is caused by the tight stitching or interlacing of the two layers along the outline of a design. Depressions occur where the fabric is stitched and the unstitched areas are raised. This stitching can run filling ways, warp ways, diagonally, or in combination, creating striped, square, diamond, etc., motifs. The embossed effect can be enhanced by weaving a stuffing pick of coarser yarn between the front and back layers, winding the back warp on a separate beam and weaving it under more tension than the face warp, and/or by using fibers with different fulling properties for the two layers.

## DRAFTING MATELASSE

Our example will have a 2 to 1 ratio of face to back threads as shown in Fig. 1 in which the shaded lines represent back threads.

by Linda Kelly

In drafting matelasse it is necessary to first separately consider each layer's weave, number of threads and picks required for a repeat, and the arrangement of stitching desired for the motif of the design. These are then combined into a draft showing a complete double weave with matelasse effect.

Fig. 2a shows a  $2\frac{1}{2}$  twill draft with 4 repeats in the warp and in the weft (16 warp ends and weft picks). Fig. 2b shows the same plan drafted on warp ends 1,3,4,6,7,9,10,12, etc. and weft picks 1,3,4,6,7,9,10,12, etc. of the double cloth.

Fig. 3a shows a plain weave for 4 repeats in the warp and in the weft (8 ends and picks—half as many as Fig. 2). Fig. 3b shows the same plan drafted on warp ends 2,5,8,11, etc. and weft picks 2,5,8,11, etc. of the double cloth.

Fig. 2 is used for the face weave and Fig. 3 for the back. This gives a twill woven face and a plain woven back.

Fig. 4a combines these two drafts. But if these two fabrics are woven as double cloth with the twill being the top layer it is necessary to lift all the top warp ends (1,3,4,6,7,9,10,12, etc.) when the bottom layer is woven (picks, 2,5,8,11, etc.). Fig. 4b shows the weave with 4 repeats and threading draft. The two layers weave simultaneously—they do not interlace. Thus Fig. 4b is a 24 thread draft. The 8 back ends and picks are spaced evenly between the 16 face ends and picks; this gives a 2 to 1 ratio. The back threads are shaded.

The threading is a six-shaft straight draw. The back threads are on shafts 2 and 5, the front warps on shafts 1,3,4 and 6. As in any double weave all face

threads are lifted for each back pick and drafted as risers ■ on all back picks. All back warp ends for each face pick are down and drafted as sinkers □ on all face picks.

To obtain a depression around or in a given design requires that the two layers be stitched at certain points according to the dictates of the design.

**A Weft-way (horizontal) depression** is achieved by raising the back warp ends as stitching risers into the face cloth in plain order at points where the face warps nearest it, or as close as the face weave will allow, rise at the same time. It is best if the back warp ends rising into the face do so either right before or after they have been raised by the weave in the back layer. (Posselt 130).

The motif shown in Figure 5 is for a weft-way arrangement of stitching. Adding this to the draft in Fig. 4b results in Fig. 6 for a complete double weave draft with a weft-way matelasse effect of the cloth. Following the arrangement of stitching in Fig. 5 the back warp ends lift into the face in plain order during the 1st, 8th, 9th, and 16th face picks. Alternate back warp ends are the stitching risers on these face picks, causing a weft way depression after every 6 face picks. Note that the threading is the same as Figure 4b. Two additional treadles are used to obtain the weft-way stitching.

**A warp-way (vertical) depression** is caused when selected face warp ends are lowered as stitching sinkers into the back cloth in plain order under alternate back picks. The same face warps should be down in the two adjacent face picks or as close as the pattern of the face weave will allow. (Posselt 130).

To obtain this effect the face warp ends that are used as stitching sinkers are threaded in plain order on two shafts. This allows them to be raised and

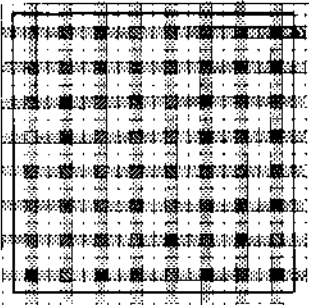
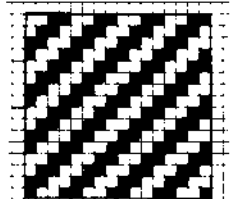

FIGURE 1.



■ risers warp up  
□ sinkers warp down

a

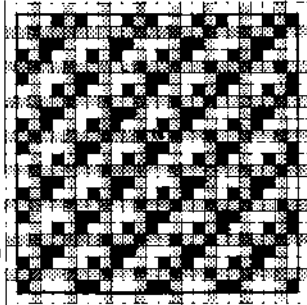
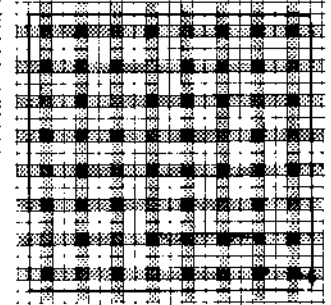

FIGURE 2.

b



a



b

FIGURE 3.

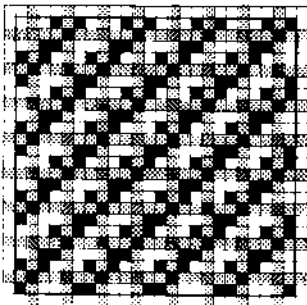

a

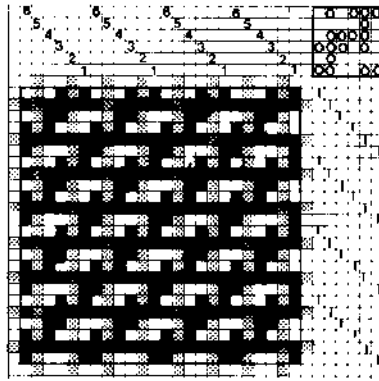

b

FIGURE 4.

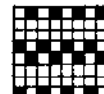
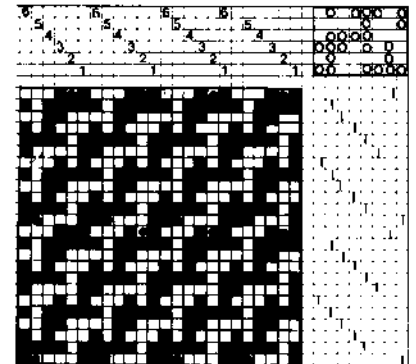

FIGURE 5.



● stitching risers

FIGURE 6.

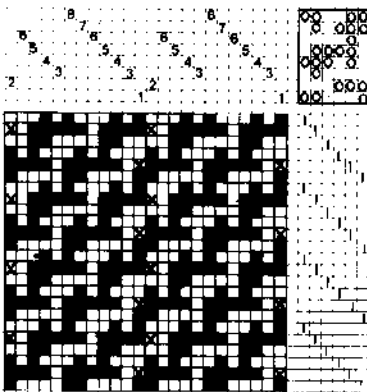
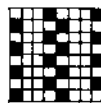

FIGURE 7



Placemat front

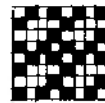
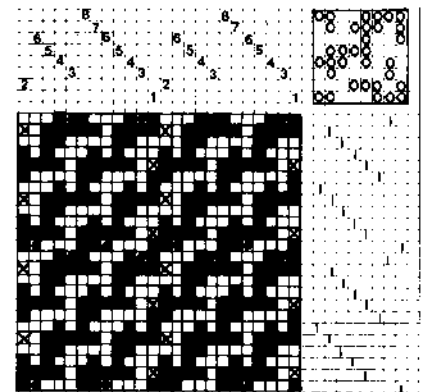

FIGURE 9.



● stitching risers  
■ stitching sinkers

FIGURE 10.

■ stitching sinkers

FIGURE 8.



Placemat back

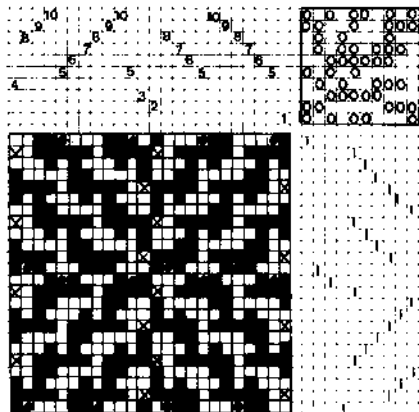

FIGURE 12.

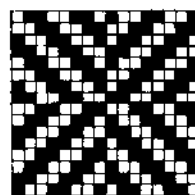

FIGURE 11.

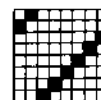

FIGURE 13.

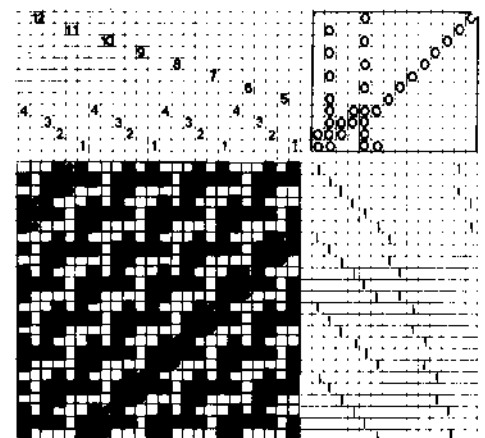

FIGURE 14.

lowered independently of each other and the remaining face warp ends so they can weave in twill order for the face weave and plain order for the stitching.

Fig. 7 is a warp-way arrangement of stitching. Fig. 8 is a complete double weave draft with a warp-way matelasse effect. Fig. 2a is used for the face weave, Fig. 3a for the back and Fig. 7 for the motif. Following the arrangement of stitching in the motif the 1st, 8th, 9th, and 16th face warp ends are the stitching sinkers  $\boxtimes$  lowered into the back cloth in plain order during alternate back picks. These are threaded on shafts 1 and 2 in plain order. The remaining face warp ends are on shafts 4, 5, 7 and 8, the back warp ends on shafts 3 and 6. To keep the 2 to 1 ratio of face threads to back threads requires that the face warps used as stitching sinkers always be threaded on their respective shafts between alternate back warp ends, the same as all other face threads (2 face 1 back, 2 face 1 back, etc.).

**Combining weft-and warp-way stitching** will produce square or rectangular motifs for a design. Fig. 9 shows a motif of this kind.

Fig. 10 is a complete double weave using Fig. 2a for the face, Fig. 3a for the back, and Fig. 9 as the motif. The threading is the same as the warp-way stitching drafted in Fig. 8. The tie-up and treadling are also the same except two more treadles are added to raise the back warp ends as stitching risers  $\blacksquare$  into the face cloth on the 1st, 8th, 9th, and 16th face picks to obtain the weft-way stitching.

### Variations

All drafts to this point have been for a  $\frac{2}{2}$  twill face with the twill running in one direction. Changing the weave of the face cloth into a broken reverse  $\frac{2}{2}$  twill as in Fig. 11 and keeping the back a plain weave and the motif the same as Fig. 9 results in Fig. 12 for a complete draft. The stitching sinkers are now threaded on 4 shafts. This allows them to weave in twill order along the opposing twill lines in the face and also in plain order as stitching sinkers under alternate back picks. The face warp ends that are the stitching sinkers are threaded on shafts 1 through 4. The

remaining warp ends are on shafts 5 through 10 with the face warp ends on 6, 7, 9, and 10 and all back warps on shafts 5 and 8. Note the tie-up and treadling sequence.

A diagonal motif as in Figure 13 is obtained by the stitching risers rising along the diagonal lines as drafted. This requires that the back warp ends be threaded on as many shafts as there are warp columns in which different stitching risers or combinations of stitching risers are contained in one repeat of the motif. Thus the arrangement of stitching in Fig. 13 requires the use of 8 shafts to carry the back warp ends. These warp ends can then rise independently as stitchers to form the diagonal stitching and also weave in plain order for the back layer.

Using the  $\frac{2}{2}$  twill of Figure 2a for the face cloth, the plain weave of Figure 3a for the back, and Figure 13 as the motif results in Figure 14 as a complete double weave draft with a diagonal matelasse effect. Observe how the same stitching riser rises into the face cloth directly before and after it rises to weave in the back layer.

The placemat shown in Photo 2 on p. 37 is woven from Fig. 12.

**WARP AND WEFT:** 3/2 perle cotton  
**SETT:**

**face:** 15 epi (60/10 cm)

**back:** 7.5 epi (30/10 cm)

**SLEY:** 15 dent (60/10 cm) reed dented 1f, 1b 1f, 1f, 1b 1f, etc.

### REFERENCES

- Nisbet, Harry, *Grammar of Textile Design*. New York: Van Nostrand Co. 1906  
Oelsner, G. H., *A Handbook of Weaves*. New York: Dover Publications, Inc. 1952  
Posselt, E. A., *Technology of Textile Design*. Philadelphia: E. A. Posselt N.D.  
Tidball, Harriet, *The Weaver's Book*. New York: Macmillan Publishing Co. Inc. 1977

*Linda Kelly was a Colorado weaver until she moved with her family to Emporia, KS. Her weaving career includes writing, teaching and creating woven pieces for shows and galleries. She is a passionate researcher in the various textile fields. Her current interest lies in the structure and design potentials of layered weaves.*

*Linda gives workshops in which her students explore various weave structures. For more information on workshops, write to Linda Kelly, 1504 Sherwood Way, Emporia, KS 66801.*

# WEAVE ANALYSIS

by Joyce  
Marquess Carey

Woven fabric is the easiest type of textile to analyze in order to determine its construction. Unlike knits, twining or other constructions, true weaving is composed of threads interlaced at right angles. At every intersection, one of the two threads is on top, the other on the bottom. Like a binary system that works on the principle of "on, off", weaving works on the system of "up, not up".

Determining the threading, treadling and tie-up for a weave is the exact reverse of doing a drawdown. Instead of starting with your weaving directions, doing a drawdown and weaving the cloth, you start with the cloth, do a drawdown, and reconstruct the directions. Although any woven fabric can be analyzed, start with one that you've forgotten the threading of, or trade samples with a friend. If it has selvages, it will be easy to tell which way the warp runs. However, if the warp direction is not obvious, you can take a guess as to which is warp and which is weft. All drafts can be rotated 90° to make the threading into the treadling, and vice versa.

All you need besides the piece of fabric are graph paper, a pencil, a needle and thread, and a T-pin or biology pick. If the weave is fine, a lighted magnifier on a stand is helpful. If it is very fine, a linen tester is almost essential. (A linen tester is simply a folding magnifier that becomes a little stand when it

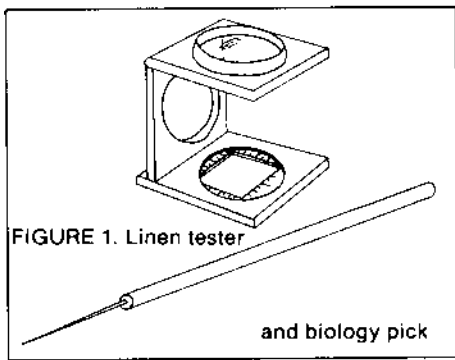

FIGURE 1. Linen tester

and biology pick

is unfolded, and has markings which help you to count the threads per inch) See Fig. 1.

First, using a thread that contrasts with the fabric, hand sew a basting line carefully between two warp threads, and another between two weft threads, making sure you have a complete repeat of the pattern. See Fig. 2. Then, make two lines on the graph paper that correspond with the thread markers as you are working. In this way, you will be less likely to lose your place and accidentally slip over into the next warp or weft row. Next, look carefully at the first warp to the left of the vertical basting thread. Starting at the first intersection below the weft (horizontal) basting thread, see if the warp or the weft is on top. If the warp

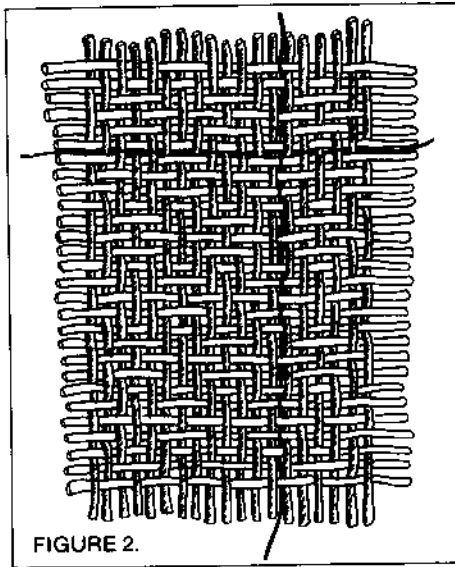

FIGURE 2.

is on top, fill in the square that corresponds to this intersection. If the weft is on top, leave the square blank. Move down the course of the warp thread, making a mark every time it lies on top of the weft, and leaving a blank every time it lies beneath the weft. When you are certain that you have a complete repeat, move to the next warp to the left, and to the next graph paper column. Continue until you are certain you have a complete repeat of the pattern.

Now that you have the drawdown, the rest is easy. First, you will determine the threading. Every vertical column equals one warp thread. All warps threaded on the same shaft behave exactly the same way; that is, they all either go up or stay down at exactly the same time. Therefore, all identical vertical columns represent warps threaded on the same shaft. Call the first column shaft number one. This is totally arbitrary, but since you don't know how many shafts you will need, it makes sense to start with number one rather than with four or eight. All other columns that match the first one exactly are also number one. I find it helpful to take an extra piece of graph paper and make a template to slide along the drawdown when looking for identical columns. See Fig. 3. Make sure to put a line on the template that corresponds to the horizontal line on the drawdown so that you don't accidentally move up or down a row. When you've found all the shaft one columns, move to the next column, call it "two", find all its identical counterparts, and so on. You will need as many shafts as there are different kinds of columns.

The next step will determine the treadling and tie-up. Starting with the first horizontal row, read across, looking for filled squares. The numbers above them in the threading draft tell you which shafts must be raised in that row. Assume you will use treadle number one to raise the warps for the first row. (again, this is arbitrary, but why not?) If shafts one and two are to be raised, for example, put o's in the tie-up under treadle number one for both shafts one and two. Using a template again, find all identical horizontal rows; they will all be controlled by treadle number one. Move on to the second row, assign it to treadle two, see which shafts are raised for the tie-up, and find all the identical treadle-two rows. You will need as many treadles as you have different kinds of rows.

As a variation, if tie-ups confuse you, assume you have a single or direct tie-up (one treadle to one shaft) and depress as many treadles as you need for any given row. This is fine for four shafts, but impractical for more. Also, it is not good if you want to turn the

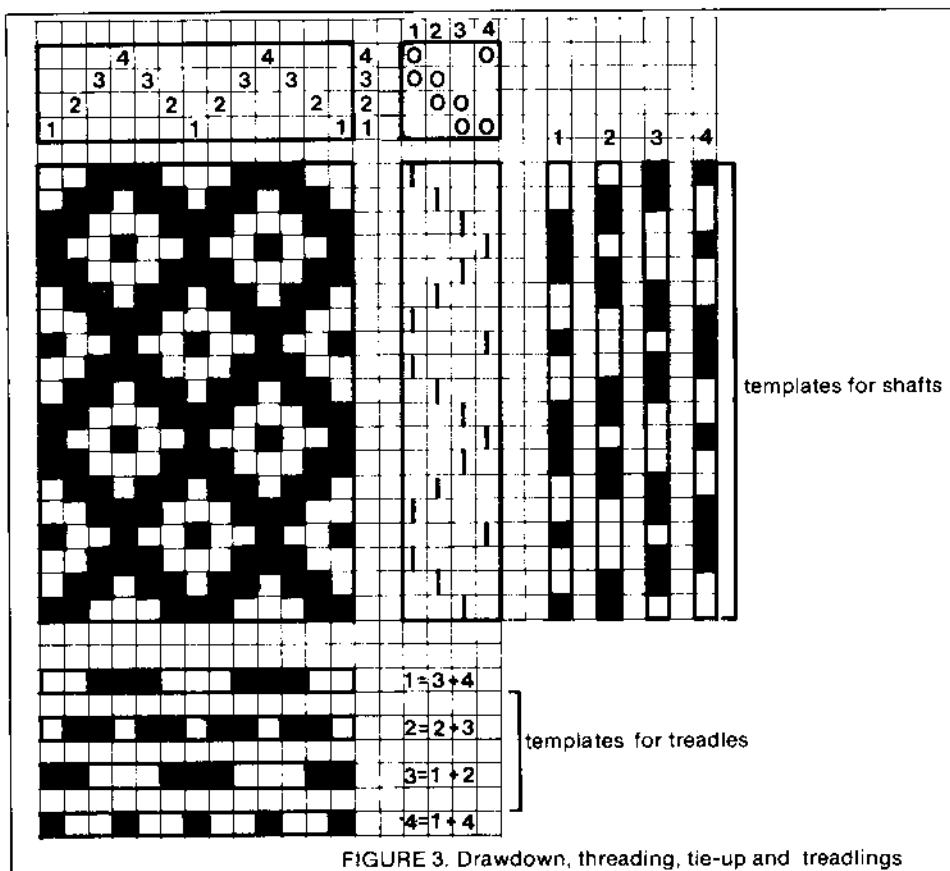

FIGURE 3. Drawdown, threading, tie-up and treadlings



draft 90°, exchanging threading for treadling.

This simple method works for multi-layered fabrics of any complexity, if you just remember that on a conventional loom, warp threads are on a single plane, and each warp gets a shaft all to itself. Multiple harness looms, such as draw or damask looms are another matter.

Certain weaves are easier to reconstruct by plotting the course of wefts rather than warps. All weft-faced weaves, and pattern plus tabby weaves such as overshot have more obvious weft characteristics than warp. As you gain experience, you may find that

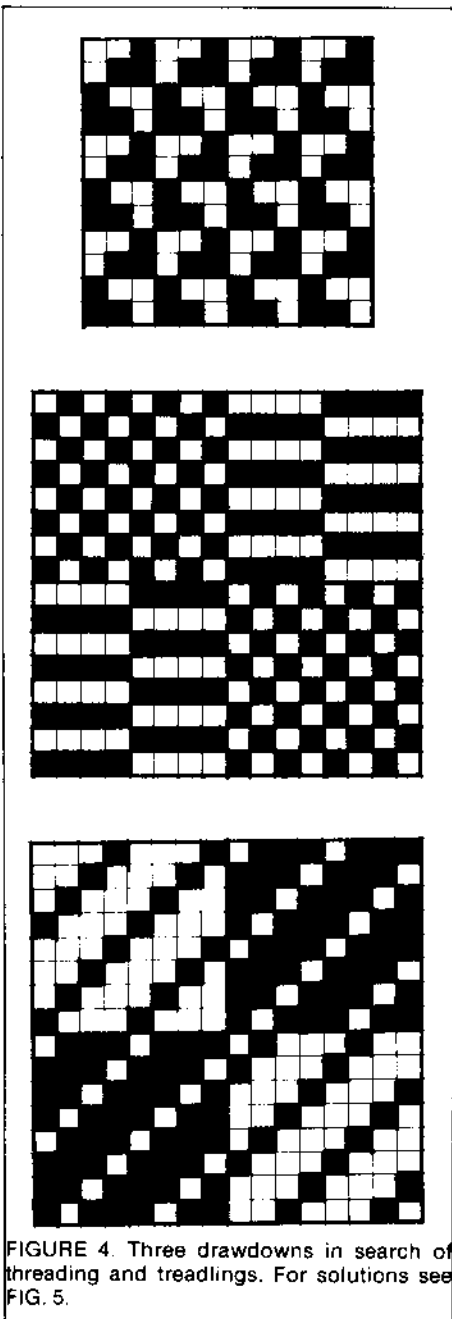

FIGURE 4. Three drawdowns in search of threading and treadlings. For solutions see FIG. 5.

plotting only the pattern wefts and leaving the tabby out will make the job faster and less tedious.

Determining blocks in unit weaves such as Summer and Winter is done in exactly the same way as thread-by-thread analysis, except that you will use a larger frame or reference. Draw a mental line, or sew a basting thread between columns and rows of blocks. No matter what width they are, all blocks that start and stop on the same horizontal line are the same block. There are as many blocks as there are different columns. Familiarity with different classes of weaves then makes it possible to do only a profile draft and insert the weave structure that was used, or put a new weave structure into the profile. In this way, you could analyze a four block double weave coverlet requiring sixteen shafts, and render it as a Summer and Winter weave requiring only six.

Once fabric analysis is mastered, you are free to pirate any interesting weave that takes your fancy. Also, the mysteries of books such as *A Handbook of Weaves*, by G. H. Oelsner (Dover Publications, New York, N.Y. 1952) will be revealed, wherein threadings and treadlings are omitted and all you have to work with is the drawdown. You can also unleash your own creative urges and look further—to knitting patterns and counted thread embroidery patterns, to decorative brickwork and crossword puzzles. Anything that will fit on graph paper will be grist for your design mill. When you find yourself looking at a high-rise office building and thinking of the pattern of windows, ledges and shadows in terms of block weaves, you will know you have truly become a weave analysis addict.

**SUMMARY**

1. All identical columns are controlled by the same shaft; each different column requires a different shaft.
2. As many shafts are required as there are different kinds of columns.
3. All separate identical rows are controlled by the same treadle; the treadle is tied to whichever shafts are raised in that row.
4. As many treadles are required as there are different kinds of rows.

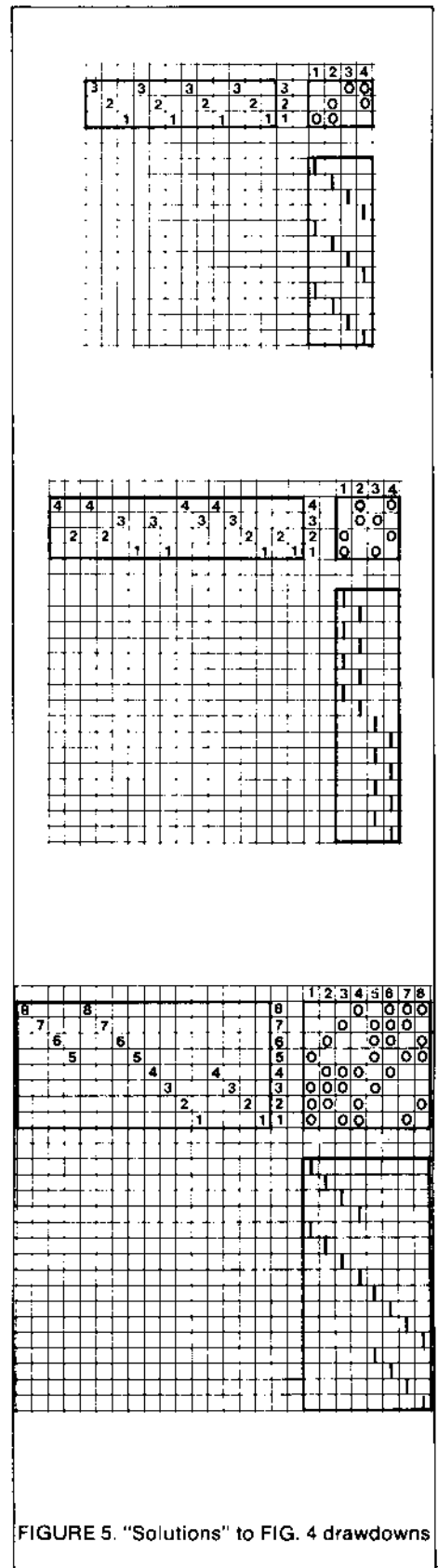

FIGURE 5. "Solutions" to FIG. 4 drawdowns

Joyce Marquess Carey is assistant professor in weaving at University of Wisconsin-Madison. She has exhibited her work actively and has received many awards. This summer she will teach at Seiver's School of Fiber Arts on Washington Island, Wis. and will give a drafting workshop July 6 at The Looms, Mineral Point, WI.

# A CARDWOVEN SELVEDGE FOR WEFT-FACED RUGS

by Martha Stanley

In this article I'd like to set forth on paper for the first time some primary principles and specific how-to instructions for executing a cardwoven selvedge for weft-faced rugs. Understanding the background principles isn't essential, but is helpful if one wants to experiment. There is a good deal of technical information here which may require more than one reading to comprehend.

The selvedge of any rug is subjected to more rigorous stress than the interior; the warp threads need to be strengthened here. The kneading action which can happen when a rug is walked on causes the warp and weft to move with respect to each other inside the rug structure, with resultant abrading of the softer of the two yarns by the harsher. Close sett, dense packing in of the weft, and non-slippery warp yarn generally minimize this phenomenon in rug weaving. But because the selvedge is more vulnerable, these additional two steps are often taken.

1. The warp threads at the selvedge are usually two- or more- fold through the heddles.

2. These are usually spaced closer together in the reed. Consequently the weave structure is much denser at the edge and the weft is pretty well unable to move about on the selvedge warps. Because the edge of the rug is higher than the adjacent floor the weft there can wear more quickly when being walked on.

The Indians of the American Southwest introduced an alternate treatment of the selvedges in their work to help keep the weft immobile on the warp threads. Usually called the Navajo selvedge, it consists of two or three supplementary warp threads which twist around each other as they take turns being encompassed as final selvedge thread in the cloth. The thread (s) not being caught by the weft will float on



*Photo 1. A glimpse of four cardwoven edges. The one on the right has diagonal stripes.*

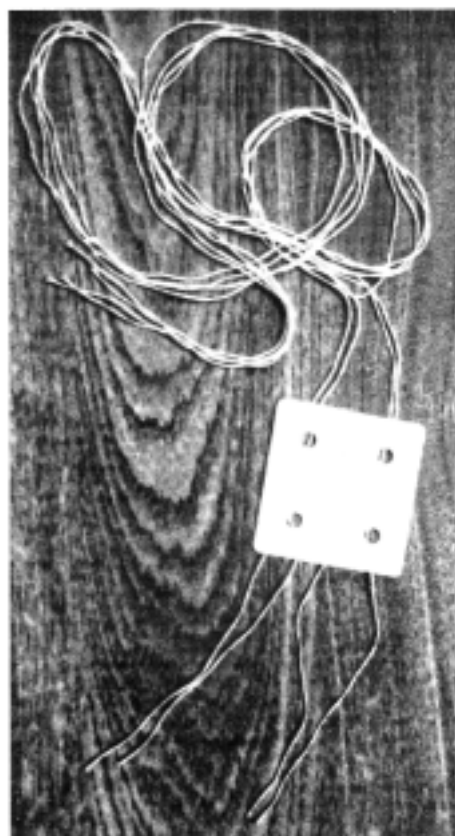

*Photo 2. A threaded card.*

the edge of the rug for a short distance before being caught again. This twining of the supplementary warp threads greatly diminishes the potential movement of the weft at the selvedge because the twining warps lock it in place with every twist. If this is not clear to you now, read on. As we delve further into the cardwoven selvedge it will become so.

About 8 years ago I wanted to incorporate Navajo selvedge in a rug I was about to weave. One complication presented itself: the Navajos use a sword (or shedstick) to open the shed for the passage of the weft. The same tool is used to separate the twining warp threads of the selvedge and to keep them lined up so that they can in turn be encompassed by the weft. The floor loom with its foot-treadled sheds begged for a solution which was suitable for its particular shedding system. Because cardweaving is a way of executing warp twining, (and also maintains an open shed) it was selected as a technique to weave selvedges.

You will need the following to try this:

- 4 4-hole cardweaving cards
- 2 1" long "S" hooks
- 2 weights of about 20-24 oz. (570-680 g) each (jugs with handles and filled with water are excellent)
- a loom with a sample warp suitable for weft-faced weaving (sett of about 4-6 epi or 15-25/10cm); plain weave threading will be easiest to begin with. If possible your reed should be a 4, 5, 6, or 8 dent one; finer than 8 dent may present problems.

Weave in sticks (which I prefer) or rags to space out your warp evenly. Now measure off 16 separate strands, each about 2 yards (1.83 m) long, of a plied weft yarn which has a lot of twist in it. This will be for your cardwoven selvedge warps. In this sample you may elect to use a yarn contrasting in color with the surface weft so that you can easily see and evaluate what you are

doing. In a rug the edge is best done in the same color and yarn as the rug so that any irregularities are camouflaged until you have thoroughly mastered this.

You now have 16 strands and four cards, each with 4 holes. Thread each strand through one hole of one card. **But be sure the threads in the holes of one card are all threaded in the same direction;** that is, with the short ends on the same side of the card. (See Photo 2) Two cards (8 threads) will be attached at each selvedge.

Take the 4 short ends from one card and sley them from *behind* the reed through the dent adjacent to the regular outer selvedge warp thread. Sley the threads from the second card in the next dent. **All threads from one card must be in the same dent of the reed.** Now advance these warps far enough through the cards and reed so you can tie them to the front tie-on rod (*not* the breast beam, please!) immediately next to your regular warp selvedge.

Now go around to the side of the loom. On each side of the regular warp bring the 8 warp threads through the shaft frames but *not* through heddles. The cards will float behind the reed. (Photo 3) It will be easiest to manipulate the cards if you allow a 2" (50 mm) wide space (free of empty heddles) on either side of the regular warp to accommodate the cardweaving warps and cards. If there are extra empty heddles on the loom beyond this, you may want to tie them out of the way. Take the cardweaving warp back over the back beam and comb the threads to even out tension irregularities. Tie the 8 warp threads in a knot close to the end but at least 18" (46 cm) off the ground. (I prefer to use a slip knot here, with the short ends stationary and the slippage occurring on the long end of the warp.) Please **note** that you neither tie them to the back beam nor beam them onto a warp beam. You are putting a warp-faced (twining) weave next to a weft-faced weave. Not only will the two weaves take up differently in the warp direction, but the twining will also build up twists behind the cards which need to be shaken out from time to time. Hence the preference for a slip knot which is easily untied.

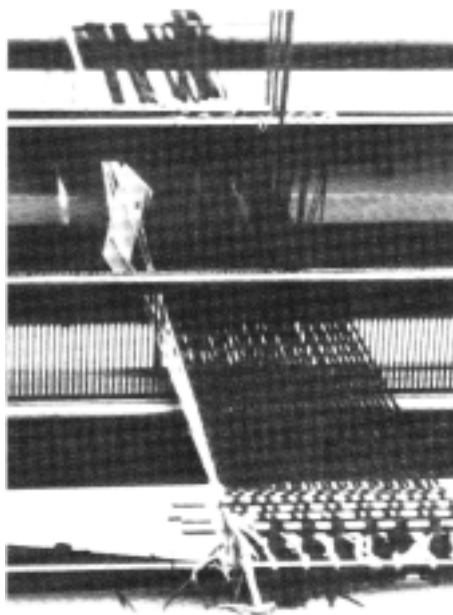

*Photo 3. The cards for one selvedge attached and ready to weave. The cord around the breast beam is attaching the tie-on rod to the cloth beam. Its proximity to the cardwoven selvedge warps is quite accidental. The top of the beater has been removed to allow for clearer viewing.*

Now, to tension the warp, take this dandy little "S" hook and put one end of the "S" through the loop of the slip knot, thread it through the handle of the bottle, and hook the other end of the "S" back around the warp just above the jug. (Photo 4).



*Photo 4. A simple way of attaching the warp tensioning weight which allows quick removal.*

The cards at each edge should be positioned fairly close behind the beater; the closer the cards are to the weaving area the greater the shed depth. Naturally if they are in front of the reed they will interfere with the action of the beater. Both cards at one edge should be exactly next to each other, with their top and bottom edges parallel to the regular warp threads. Play with their positioning until you get all 4 top layer threads in one plane.

The cardwoven selvedge will be woven in a similar fashion to the traditional floating selvedge. Let me briefly explain how the latter works. The final regular selvedge warp unit is not threaded through a heddle but heads straight from the reed to the back beam. When the shed is open this floating selvedge bisects the center of it, blocking clear passage of the shuttle, see Fig. 1. The shuttle enters the shed **OVER** this obstruction and exits **UNDER** its counterpart at the other selvedge. It is this concept of the shuttle's passage consistently one way as it enters and in a different position with respect to the floating selvedge when it exits which will help you with what we are about to do. We might say that the cardwoven selvedge functions as a more intricate floating selvedge. Our rule is slightly trickier than the one I have just cited for the traditional floating selvedge.

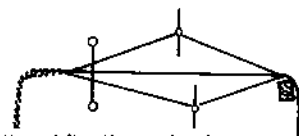

**Figure 1. Traditional floating selvedge**

In weaving the warp-faced cardwoven selvedge right next to a weft-faced cloth we are not able to change the shed of the cards as often as in the weft-faced area; there are far fewer picks per inch in warp-faced weaving than in weft-faced. Our cardwoven edge would become, at best, a ruffle if we attempted to change card sheds with every pick of weft. On the other hand if we simply throw the shuttle through the cardwoven shed every pick and don't turn the cards the weft will unweave itself in the cardwoven area just as it would if we threw the shuttle back and forth without changing the shed in regular weaving. The weft must have something to loop around at the edge to hold it in place.

Our solution is to alternate weaving a pick through the shed of the cards with a pick in which the shed is bypassed, thus looping around one layer of the card shed. That means that the shuttle will pass both above and below one layer of the cardweaving warps, *always* encompassing the threads which are in that layer and *always* ignoring the threads in the other layer, which then float. The card shed is changed approximately every quarter inch, so the threads all take turns being encompassed and floating and there is a pleasant angular twining stitch created on the edge by the floaters.

Proceed as follows: Open the shed on your loom and examine the relationship of the cardweaving shed to it. Often the CW shed is slightly out of alignment with respect to the regular warp so that passage of the shuttle both above and below one layer of the CW shed would be easier than above and below the other layer (Photo 5). Based on the relationship of the two open sheds (CW and regular) you need to determine which CW layer will be easier to encompass, that is, easier for the shuttle to maneuver both above and below. Let us define the three possible places for the shuttle to pass with respect to the CW shed layers as over, through, and under. See Fig. 2. Once you have selected your layer, proceed to weave using the rule which seems most comfortable for encompassing that layer.

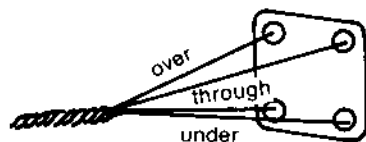

Figure 2.

For the top layer:

1. Enter the shed with the shuttle in the OVER position and exit THROUGH or
2. Enter the shed with the shuttle in the THROUGH position and exit OVER

For the bottom layer:

3. Enter the shed with the shuttle in the THROUGH position and exit UNDER or
4. Enter the shed with the shuttle in the UNDER position and exit THROUGH

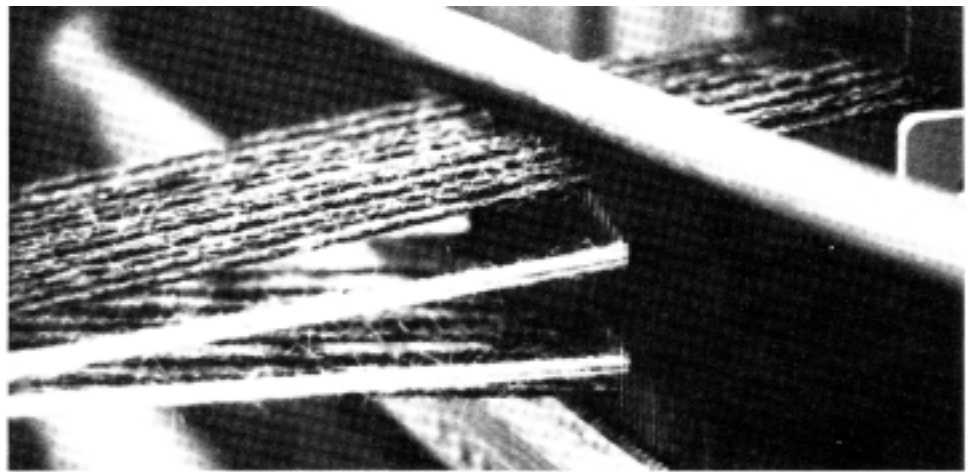

Photo 5. In examining the two open sheds, the shuttle can clearly maneuver more readily both above and below the top layer of the cardwoven warp shed than the bottom layer.

Photo 6 illustrates weaving with rule #1.

Once a rule has been chosen, you will be using it *exclusively* with every weft pick of that project.

Don't forget to pull the weft taut at the edge so the CW selvedge is tightly against the regular warp.

When the fell of the cloth has advanced about a quarter inch you need to change the shed of the cards at both selvages. After you have beaten in this last pick of weft leave the beater resting at the fell of the cloth. Lean over the beater and rotate the edge of the cards which is closest to you up to the top position (a 90° or quarter turn away from the cloth). All cards are turned the same amount after the same number of picks. After a bit of familiarity with this operation you'll be able to turn both selvages at the same time.

To maintain a clear shed keep both cards of the same edge in exactly the same plane. Now put your fingers in the shed directly in front of the cards and bring the shed change forward to assure that the new shed is transferred through the reed. Return the beater to its resting position, and with your fingers transfer this shed change down to the fell of the cloth. This must be done with the fingers and is necessary only after turning the cards. Note that you will have to have woven four turns of the cards or one inch of cloth before this edge twining looks like anything, since only then will you have completed one repeat.

As the shuttle manipulation is mastered you need to focus on fine tuning how often to turn the cards. Two factors are involved here. One is the

amount of twist in the CW warp threads. Over-twist yarns will greatly enhance the appearance of the edge and also increase the durability during wear. Also, the more often the cards are turned (usually 4 to 6 times per inch), the handsomer the edge will be. Note that there is a fine line between turning the cards often enough and turning them too often. If turned too often the edge will flute slightly. Check for this by monitoring whether the fell of the cloth is straight across or slightly closer to the beater at the edges. (Too much weight on these warps might also cause a distortion at the edge.) Remember that for other projects the frequency with which you turn the cards may change because of different sett and weave, and different weight of weft, different weight of yarn for the CW selvedge warps.

You are guaranteed a rapid path to madness if you don't rely on mnemonic aids to help determine how often to turn the cards. For example, if you are doing plain weave with a single shuttle, turn the cards after an even number (2, 4, 6, . . .) of picks, or so that the shuttle is always at the same edge. Or if you are weaving a 3 pick repeat as in Krokbragd, turn the cards after 3, 6, . . . picks.

The edge will be most durable and handsome if the cards are always turned at the same frequency and always in the same direction. Reversing the direction of turning the cards produces longer floats at the point of change; these are awkward. Reversals also compromise the durability which this edge treatment gives the selvages.

As the weaving progresses twist (in the opposite direction to that occurring in

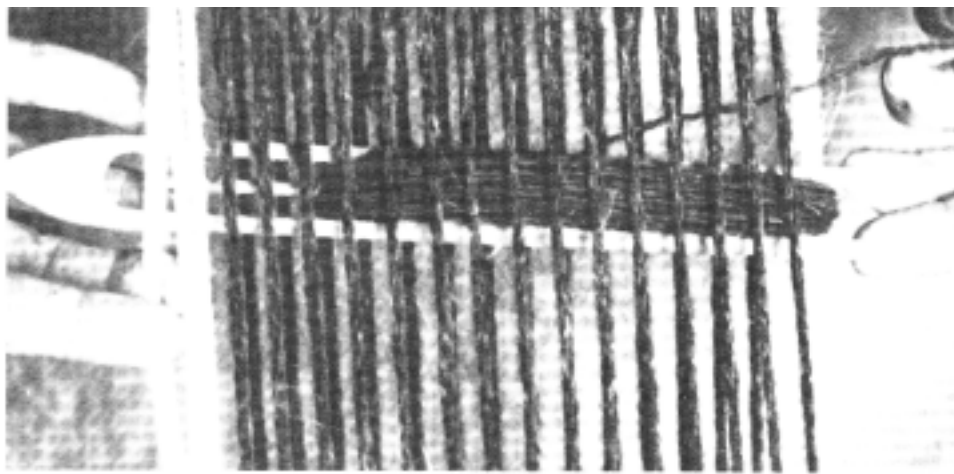

Photo 6. The shuttle entering the shed *OVER* the top layer of the cards and exiting *THROUGH* the card shed (rule 1).

the twining) builds up in the warp threads behind the cards at the same rate with which it is woven into the rug. This can become somewhat pesky after a bit. It exerts a certain torque on the cards and tends to create a twist which counteracts the opening of the shed of the CW warp and perhaps also causes tangling in the regular warp. Sometimes the cards will flip-flop over 180° so that the shed coming from them will become doubled. (Fig. 3) Straighten the cards and shake out the accumulated twist before proceeding. It is probably a good idea to shake out this twist every 6 to 12 inches (15 to 30 cm) of weaving. This twist is in the opposite direction to that occurring in the twining and if allowed to accumulate too considerably will actually alter the spin of the CW warp threads. To shake out the twist untie the (slip) knot at the weighted end of the warp. Run your fingers *between* the groups of 4 threads emanating from each card to the end of the warp. These groups tend to counter-twist around each other, locking in the twists of the 4 threads. Once separated it is easy to untwist the threads of each card. Let each warp drop free of contact with its neighbors for a moment so that it may relax. This last is particularly important if the rug is a long one.

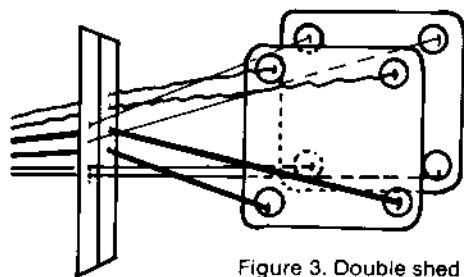

Figure 3. Double shed

The layer of CW warps which floats comes from either the top or bottom

shed of the cards. Consequently it is quite natural for those threads to float more toward the corresponding surface of the rug than right on the edge. If a rug is to be reversible it is quite annoying not to have it right on the edge. Two methods of attack may be utilized to encourage its placement crisply on the edge.

The first and easiest involves human persistence, and is easier to execute while you are learning this technique. Every time you turn the cards and beat down the new card shed, grasp the new shed of floating warp threads and pull them firmly to the opposite surface of the rug. Thus, for example, if the edge is creeping toward the underside of the rug's edge, hook your fingers around the lower layer of CW warps (which are the floating threads) and as you bring the new shed change down to the fell of the cloth pull these hooked threads up to the top surface. This will encourage the twined shed just com-

pleted to remain more on the edge.

This method will help to rectify the problem but does not respond to the structural dynamics at work here. A better solution involves relating the twist of the floats to the layer of threads that is floating. Look closely at the twined stitches on the edge of the sample in Photo 7. The slant of the floats is down toward the underside in the direction of the cards. Note that the camera's view in Photo is with your eye nearly in the same horizontal plane as the cloth. You should view your own cardwoven selvedge at each edge from this angle to make the observation in Fig. 4. The following principle seems to

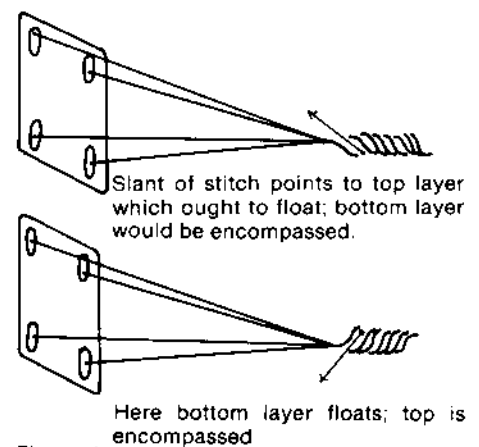

Figure 4.

wed the interacting components of this technique into a harmonious solution—right on the edge! **The slant of the floats ought to point toward the cardwoven shed layer which floats on the edge. The other layer is encompassed by the weft.** We may either change our

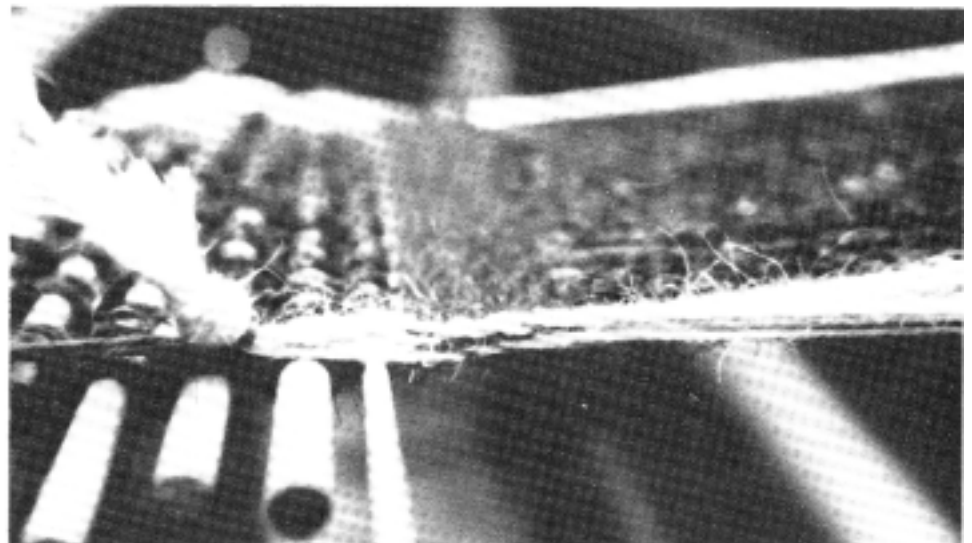

Photo 7. A sample with about 1½ inches woven.

rule to encompass the correct layer or we can flip the cards, reversing the slant of the stitch.

Flipping the cards involves rotating each card separately on its vertical axis. Let me elaborate. When you examine the cards on the tensioned warp threads you will note that the straight line of the warps causes the cards to angle slightly when viewed from above. This angle of the card represents the direction of slant the twined stitch will take in the cloth if the cards are turned *away* from the cloth when changing sheds. To change this from one angle to the other, that is to flip the card, hold the card near its top edge and increase the degree of the angle until it can no longer move freely. (Fig. 5). Now the card is angled in the opposite position and the stitch will slant in the opposite direction in the cloth.

When you first set up your CW selvages on the loom for a project examine the angle of each card and flip it if necessary so that all cards represent the angle of the twining you might desire. Having the two cards at one edge angled in opposite directions—or countered—will also help to keep the twining on the edge, but it is not always as handsome in appearance.

In a rug the cardwoven selvedge warp will need to be longer than the length of the regular warp. There will be some take-up in its weaving because it is warp-face. You want at least two feet (61 cm) of warp length extending behind the cards to absorb the twist back there. You may also desire some extra at each end to be incorporated in any fringe treatment. Making your CW warps 2 yards (1.8 m) longer than the length of your rug will meet all these criteria.

The number of cards at the edge depends on the thickness of the body of the rug and the thickness of the yarn used for the CW warps. You do not want this edge any more than slightly thicker than the body of the rug or it will be more vulnerable to wear. Two cards are generally easier to work with



Photo 8. Four cardwoven selvages showing off.

than just one at the edge. Three afford some design possibilities but might be too thick.

You will get durable results at the selvages if your regular warp is strengthened by doubling in the following way. Assuming your regular warp threads are single through heddle and reed across the center of the rug, double them for the two warp units just prior to the CW selvedge. Then have a single strand encompassed with the CW selvedge. (Fig. 6).

For those of you who know and love cardweaving there may be pleasure to see it utilized in this way. You may choose to push the cardwoven selvedge much further than I have by experimenting with others of the myriad of games cardweaving has suggested over the centuries.

After 8 years of experimenting with a cardwoven selvedge on nearly every rug woven since I first used it, I think the edge's benefit can be stated thusly: well woven, with the twining occurring at the proper frequency, it becomes a sure deterrent to any movement of wefts on the selvedge warps. Its twining floats will provide a bit of

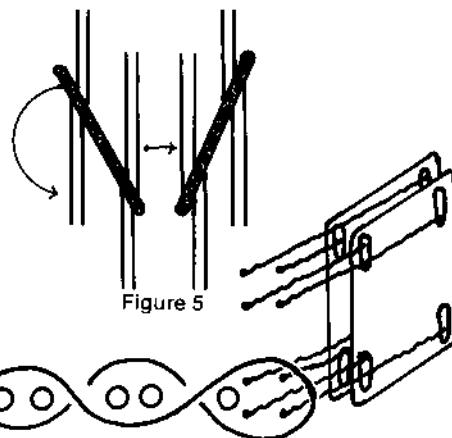

Figure 6

further protection for the weft surface at the rug's edge. Additionally it can be—indeed, ought to be—an attractive and non-competitive decoration. Once mastered it is smoothly and speedily executed.

For some of the weaves in which a floating selvedge is recommended to produce a firm and reasonably satisfying edge, the cardwoven edge may produce more attractive results. With some of the pattern threadings, particularly double-faced weaves, its *visual* results are not as satisfactory as might be obtained in other ways. I have not experimented much with it for them, though, and would be interested in feedback on experimentation by others in this area. Most of my rug weaving for the past few years has been based on plain weave structures, where it is imminently appropriate.

The cardwoven selvedge is no "weaver's wonder drug." There is a fine line between its protecting the edge of a rug and its being so much thicker than the surface of the rug that it invites premature wear in that area. Its use should involve sensitivity and a critical eye for what it is and is not doing for you. Used carefully it offers structural strength and interest. Its visual appearance contributes an elegant, yet understated sense of finish to a rug; rather like a well chosen picture frame.

By no means is its use restricted to rugs. In fact it can become a far bolder and more decorative element where some of the rigorous restrictions of rug weaving do not apply. I hope this article will encourage you to try the edge and join with me in a spirit of adventure as we further explore its potential.

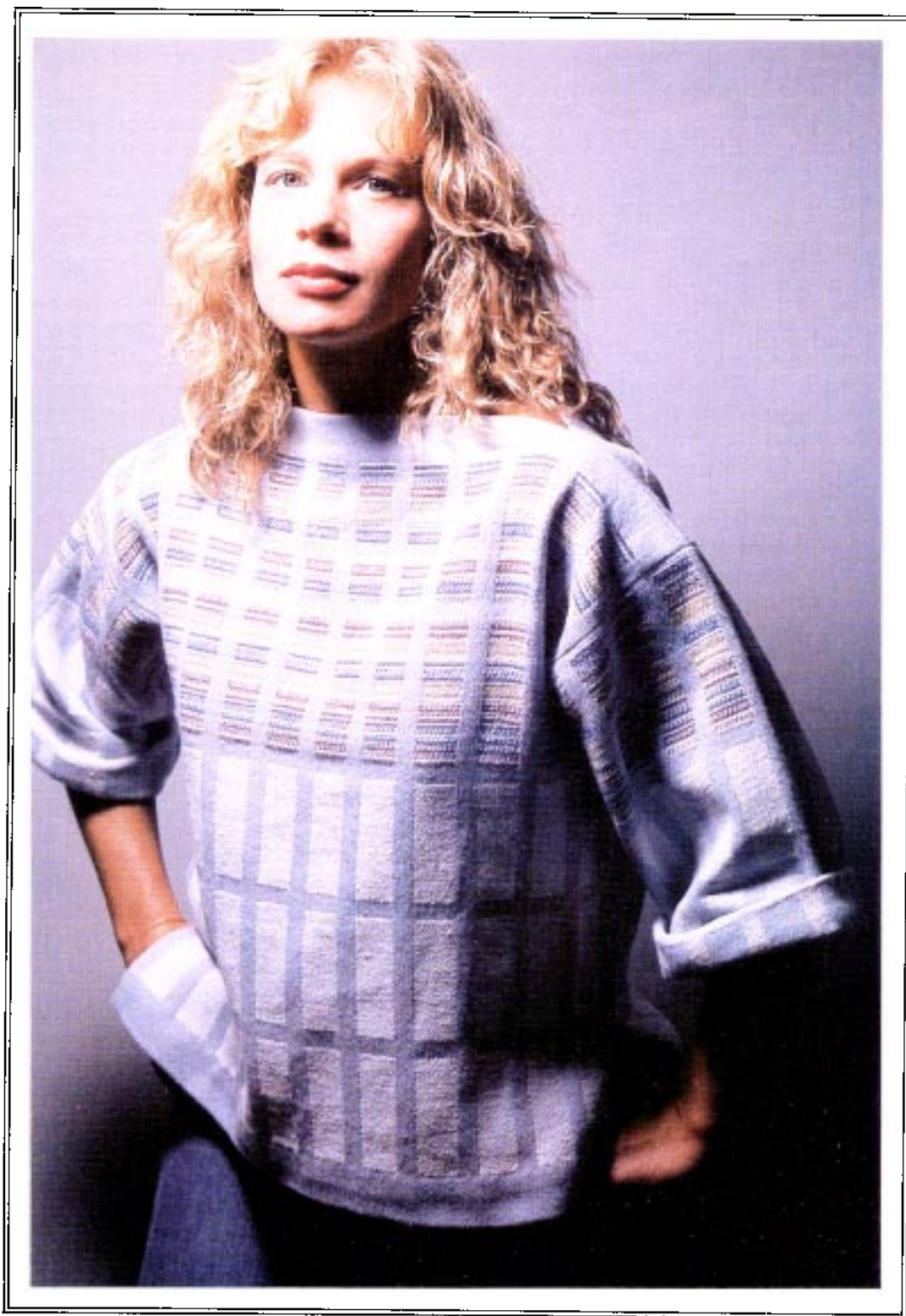

# LINBOGARN SHIRT

by Jean Scorgie

Berga has added a new yarn which they call Linbogarn to their line of quality wools and linens. Linbogarn is 60% cotton and 40% linen and comes in size 22/2. It combines the best characteristics of both cotton and linen. It has a soft hand, a slightly uneven texture, and it

comes in a gorgeous range of 64 muted colors. Linbogarn is comfortable for summer garments because its fiber content allows to breathe and makes it moisture absorbent. While this yarn is beautiful in many weaves I decided I would like to make a weighty fabric

with body, but very flexible and soft, for a simple summer overblouse. I chose 10-harness damask which would give two blocks of 5-shaft satin, one warp face and the other weft face. In this structure the blocks would be quite solid color.

My other reason for choosing this structure was that I could weave rectangles containing a series of stripes. These stripes and their meaning came from a different project I have been involved with—computer designing for weaving. Portland Handweavers Guild has an active computer study group. One of our projects this year grew out of the stripe pattern of the Universal Product Code on grocery items. One of our members was staring at the Code on a milk carton at breakfast one morning and exclaimed to her husband. "That must have been designed by a frustrated weaver!" After investigating different codes we chose Bar Code 39, an alphanumeric code. We designed our computer program so that we can type in names and numbers and out comes the equivalent in Bar Code 39. The bars and spaces can be translated back into letters and numbers by a light pen hooked to a small computer which looks like a handheld calculator. We thought it would be fun to use this 'secret code' in weaving—thus the series of small stripes in some of the rectangles. The shirt says 'Weavers Journal' on the front, 'Clotilde' on the left sleeve, and 'Barrett' on the right.

Bar Code 39 is an alphanumeric code with a bar configuration for each letter and number plus some punctuation marks. The designation comes from the fact that the code has 9 elements (5 bars and 4 spaces), 3 of which are wide. To use the code manually, one consults the table for the position of 1 unit for a narrow element, 3 units for a wide element, and 2 units between letters. Interpreted in the stripe pattern of the shirt, each unit was one weft row. Different colors were used to differentiate the configuration for each letter even more.

**WARP:** Berga Linbogarn, 22/2, 6400 m/kg, 250 g spools, light blue, No. 2782, 2 spools.

**WEFT:** Same as the warp but in the following colors: white, blekt (bleached), 1 spool; red purple, No. 2426, 20 g; dark violet, No. 2734, 20 g; light green, No. 4765, 20 g.

**SETT:** 30 epi, 2 per dent in a 15 dent reed (60/10 cm, 2 per dent)

**WIDTH IN REED:** 26" (66 cm)

**THREADING, TIE-UP, AND TREADING:** See Fig. 1.

**WARP LENGTH:** 4 yd. (3.66 m)

**FINISHING:** Regular machine wash and dry.

**SHRINKAGE:** 12% in each direction.

**WEAVE PLAN:** See Fig. 2.

**WEAVING:** Use white weft throughout. In the strip blocks use the colors for the dark stripes and white for the spaces of the Bar Code. Beat all rows hard.

**FINISHING:** Before cutting and sewing, wash and dry the fabric.

**CONSTRUCTION:** Stitch along cutting lines and cut pieces apart. At the top of the garment, fold a 2" (51 mm) facing to the wrong side, press. Sew shoulder seams along the pressed fold leaving a 12" (30.5 cm) neck opening. Along the edge of the facings fold a narrow hem and sew it by hand invisibly to the line formed by the top of the first row of blocks. Center the sleeves on the shoulder seams and stitch. Stitch underarm seam. Stitch side seams leaving the lower 6" (15 cm) open for slits. Fold a 2" (51 mm) hem at the lower edge and finish same as the neck facing. At sleeve edge fold under 1/2" (12.5 mm) twice and stitch. Press.

**YARN SOURCE:** Berga Linbogarn is available from Caryl Gertenrich at the Wool Gallery, 459 High SE, Salem, OR 97301. She will have a booth at Convergence '82.

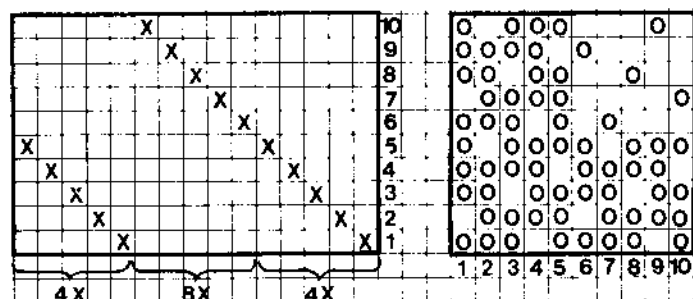

FIGURE 1

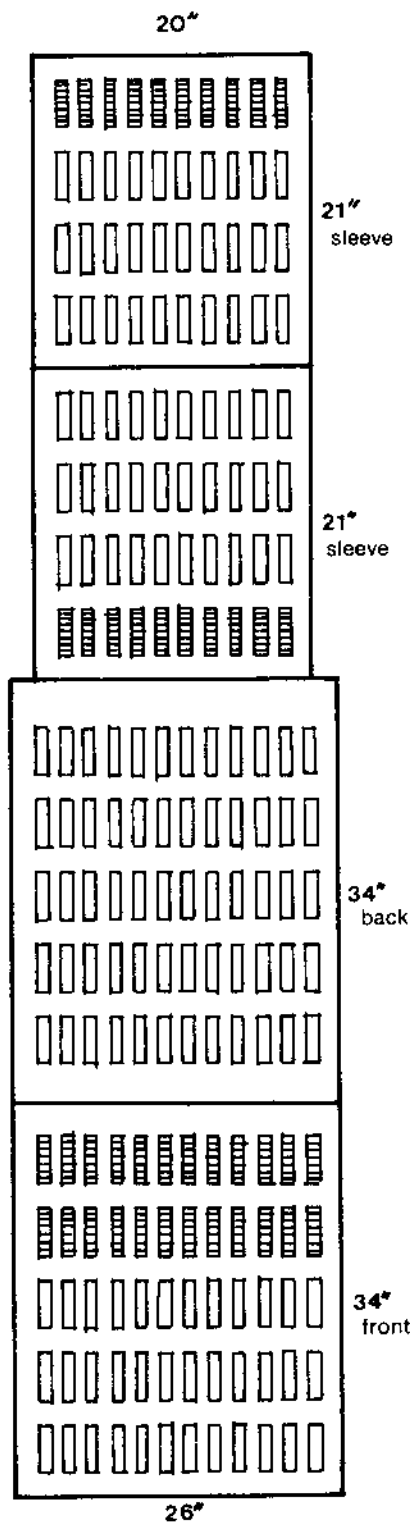

FIGURE 2



## CODE CONFIGURATION

CODE 39 derives its name from its structure which is 3 out of 9. Each character is represented by 9 elements (5 bars and 4 spaces between the bars): 3 of the 9 elements are wide (binary value 1) and 6 elements are narrow (binary value 0). Spaces between characters have no code value. The specific structure of each character is given in Table 1.

At the standard density of 9.4 characters per inch, the narrow bars and spaces are .0075 inches in width and the wide bars and spaces are .0168 inch. In other printing densities, the nominal ratio of wide to narrow elements should exceed 2.2:1 but be no greater than 3:1.

TABLE 1 CODE 39 Code Configuration

CHAR.	PATTERN	BARS	SPACES	CHAR.	PATTERN	BARS	SPACES
1		10001	0100	M		11000	0001
2		01001	0100	N		00101	0001
3		11000	0100	O		10100	0001
4		00101	0100	P		01100	0001
5		10100	0100	Q		00011	0001
6		01100	0100	R		10010	0001
7		00011	0100	S		01010	0001
8		10010	0100	T		00110	0001
9		01010	0100	U		10001	1000
0		00110	0100	V		01001	1000
A		10001	0010	W		11000	1000
B		01001	0010	X		00101	1000
C		11000	0010	Y		10100	1000
D		00101	0010	Z		01100	1000
E		10100	0010	.		00011	1000
F		01100	0010	*		10010	1000
G		00011	0010	SPACE		01010	1000
H		10010	0010	\$		00110	1000
I		01010	0010	/		00000	1110
J		00110	0010	/		00000	1101
K		10001	0001	+		00000	1011
L		01001	0001	%		00000	0111

Figure 1 shows dimensions (enlarged) for standard 9.4 character-per-inch bar code.

The start/stop (\*) code precedes and follows all encoded data, defining the beginning and end of the code. These symbols typically are not transmitted by the bar code scanner.

A white margin must be present at both ends of the printed code. The minimum white margin is one-half of a nominal character. If practical, the margin should exceed 1/4 inch so that an operator can easily begin scanning in the margin.

FIGURE 2 CODE 39 STANDARD 9.4 CPI DENSITY (Enlarged)

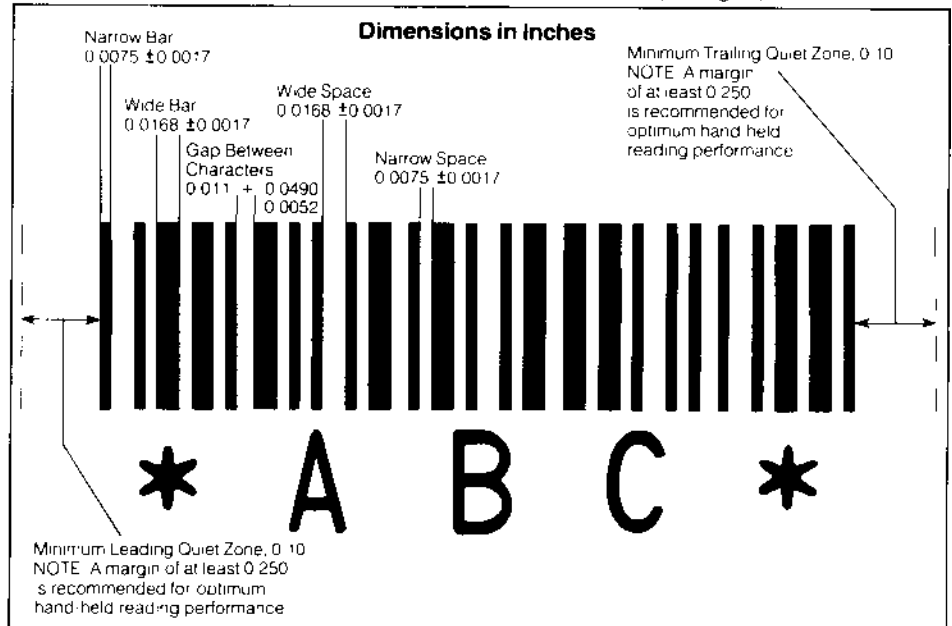

© 1982 Interface Mechanism, Inc



Weaver's Journal in CODE 39, which determined the horizontal stripes woven in the blouse shown on page 51.

Jean Scorgie is a professional weaver in Portland, Oregon. She is also a weaving instructor and has taught at Bush Barn Art Center in Salem, Oregon School of Arts & Crafts and Lewis & Clark College in Portland. Jean has an MS degree in applied art from Iowa State University in Ames. She has woven five major commissioned works during the last five years. She also leads Weavers' Tours to various foreign countries. At the last HGA Convergence in Fort Collins, Colorado in 1978, Jean was a speaker and a workshop leader.

# Unique Technique for A BRAIDED STRAP FROM COLOMBIA

The *mochila* (bag) pictured in Photo 1 was sent to me by Marjorie Cason\*. It had been produced by the Arawak Indians in the Sierra Nevada part of the Andes in northeastern Colombia. The body of the bag is done in simple looping (Fig. 1) in a bold design of black and white, and the strap is attached to it with a series of figure-8 stitches. When wearing the bag, I noticed that the strap fitted my shoulder comfortably and did not tend to slide off as many straps do. Perhaps this was partly due to the character of the braid, and partly to the texture of the handspun yarns. The white ones are thicker and a bit bumpy, while the darker ones (black and white plied together) are finer and more overspun.

In Santa Marta, Margie had briefly seen Mary, a fellow missionary, working on such a strap, but not long enough to learn how. Mary had left and would not return for several months. She had learned how to make *mochilas* when she had lived with the Arawak Indians for a number of years, "because the Arawaks consider you lazy if you don't learn how!"

When I examined the strap, I noticed that there were uncut endloops at each end under the figure-8 lacings, and that it was braided in a chevron design with all the chevrons pointing in the same direction. The structure is oblique interlacing, braided side-to-center, with an even number of strands (16L. &

16D) all going over-1, under-1, with a 2/2 interlacement down the center (Fig. 2; Photo 2, a & b). Margie stated that many of these braids are also done with a 2/2 twill structure, having a 3/3 crossing down the center (Fig. 3; Photo 2, c & d). There are longer floats down the center of both types of braids to compensate for the even number of strands and for the fact that the outside strands at each edge are either put down (Fig. 2) or lifted up (Fig. 3).

Being puzzled about how the uncut loops could be braided with no meet-

\*Marjorie Cason was Adele's co-author for *The Art of Bolivian Highland Weaving*, Watson-Guptill, 1976. She is on a 4-year mission in Colombia with her family.



Photo 1. Bag (*mochila*) made by Arawak Indians in the Sierra Nevada region of northeastern Colombia.

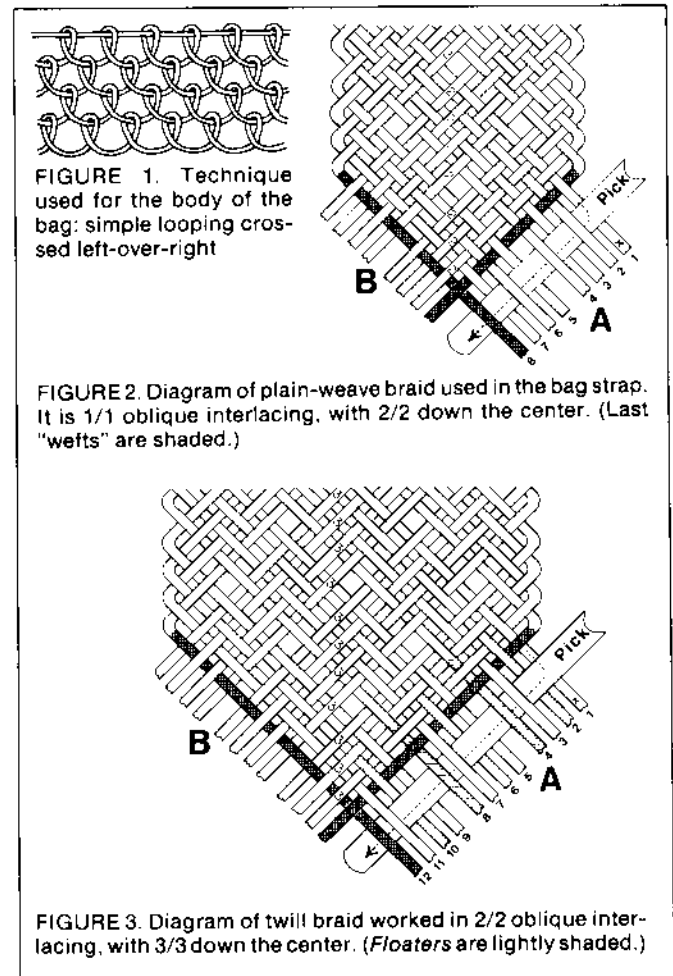

by  
**Adele Cahlander**

ing line or terminal in the center, and with all the chevrons pointing in one direction, I set up a small warp for experimentation. As I had expected, my attempts all resulted in a mess at the near end or, if put in order, it became a mirror-image as with sprang. I wrote to Margie, appealing for some clues. . . . Fortunately, she replied with enough help so that I was able to figure it out! I found that it is actually much easier to braid than when the ends are cut. The yarns are handled as loops, somewhat like the five-loop braid (Cason & Cahlander, pp. 143-4). Only one half of the warp-width needs to be picked, and there is a special trick that makes it work.

In the meantime, I had written to Robin Woodhouse in England about the puzzle. In his reply he said that he had learned the solution several years ago from Noemi Speiser (Switzerland), who in turn had found the technique in an unpublished thesis on Colombian textiles by Marianne Cardale de Schrimppf. He described how Guajirán men in Colombia's northeastern peninsula make the same braid using two vertical stakes in the ground. . . . More recently, Margie's friend Mary returned, and they were able to edit my text together.

**PLAIN-WEAVE BRAID**

For your first sample, use coarse wool yarns and make your warp loops only 12 to 15 inches long. Have two colors, dark (D) and light (L), and wind only 8 loops (4D & 4L), making 16 strands. Later, try having more loops, varying the kind of yarn and the proportion of colors, ex. 2D, 4L, 6M & 4W loops.

**PREPARING THE WARP.** According to Margie, the Indian women warp using a big toe and a hand, but you may want to use posts or a clamp. Loops are wound as a simple circle



Photo 2. Author's braid samples. a & b: plain-weave; c & d: 2 1/2 twill. Note that the braids become warp-faced, with the oblique wefts concealed.

rather than as a figure-8. Wind the 4D loops; tie the ends with a square knot. Then wind the 4L loops and tie. Secure all these loops firmly together at the knotted end with a cord by making a larkhead around them, and tie the ends of this cord to make a hanger-loop (Fig. 4) to hang from your toe or a post.

Keep the yarns in an open circle. You will do your picking to the right of the hanger-loop with the A warps. The B warps hang loose to the left of the hanger-loop.

**WEAVING THE BRAID.** Extra care is needed in the first few rows to keep the yarns in order. To pick the warps for the first row, arrange the A yarns side by side on your left index finger in the order in which they were wound: 4D at the right, 4L at the left. (The method to be used for all subsequent rows will be described under Step 6.)

1. Picking: With the right index finger, weave over the far right warp (x), under the next, and continue going over-1, under-1 for all the A warps (Fig. 5).

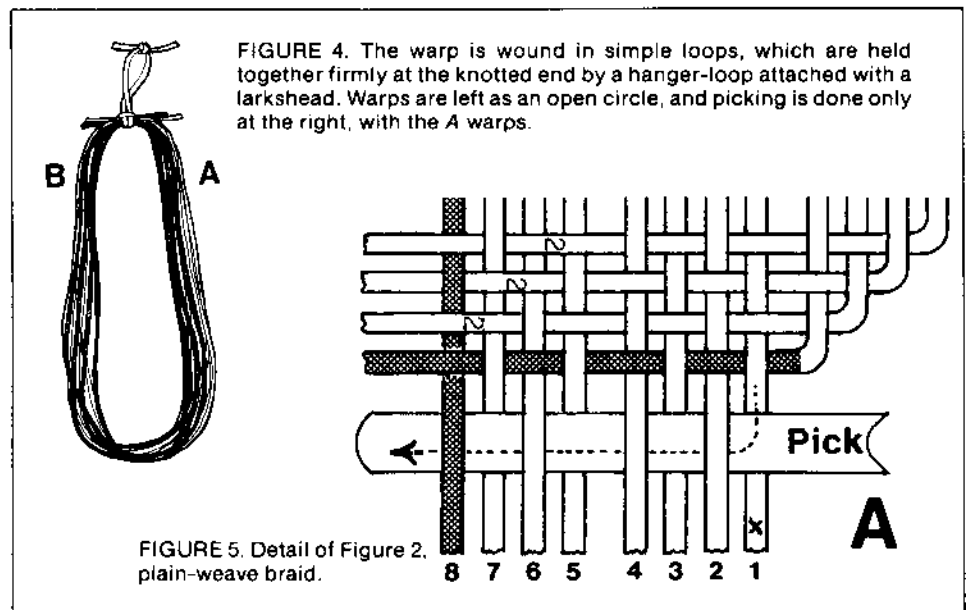
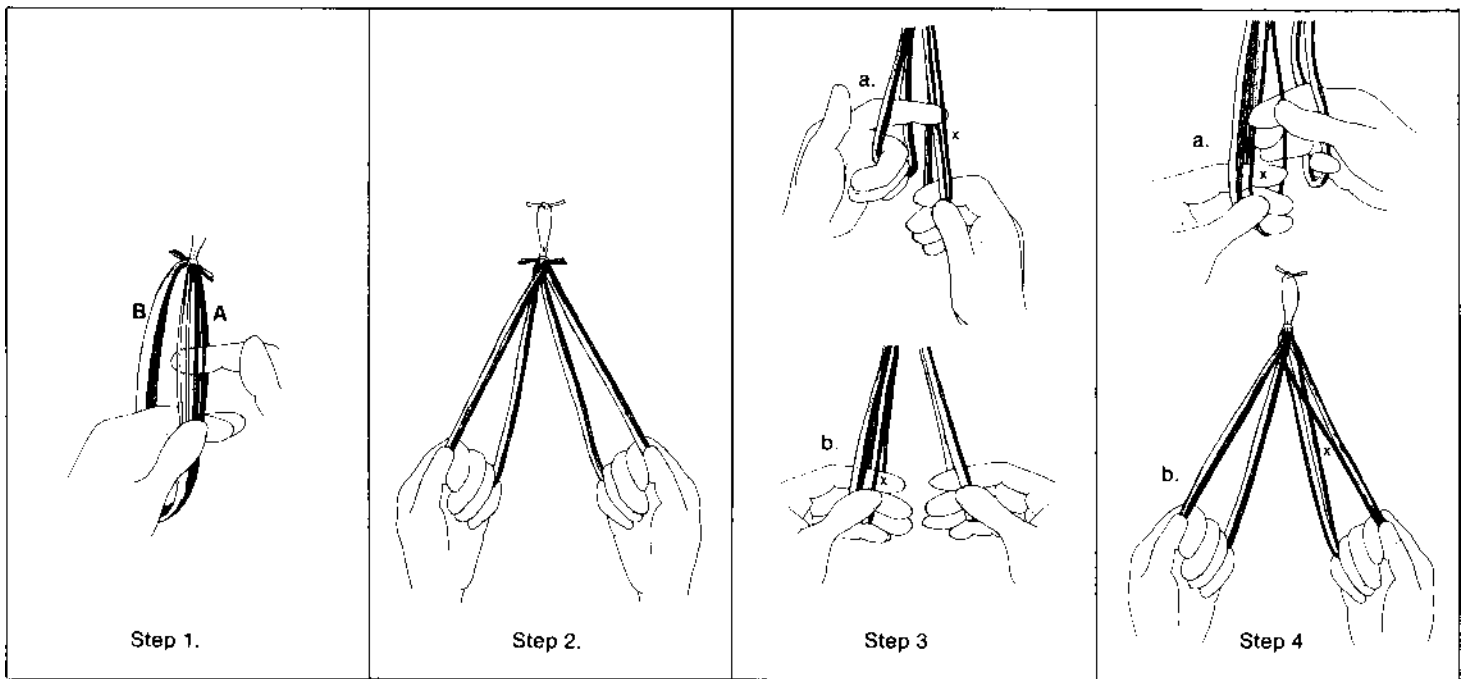

FIGURE 5. Detail of Figure 2. plain-weave braid.



2. Transfer picked (upper) **A** warps to left fingers, putting right fingers under the alternate dropped **A** warps. Slide both hands down to the ends of the loops, opening the shed. Pull taut, stretching arms apart, to open shed of **B** warps also.

3. Pull warp loops toward you, and with the left index finger, grasp warp **x** (which is now at far right on the right fingers) and hold it between the groups of warps.

4. With your right fingers still in their loops, reach under the lower part of the warp **x** loop, adding it to the warps on your right hand. When the top half of the loop drops, a figure-8 will be formed.

5. Temporarily transfer all loops from your left hand, putting them to the left of the loops on your right fingers, and hold all loops taut. This frees your left hand to do some beating. Insert the left index (#1) and middle (#2) fingers within these left loops, but around the group of right loops, in the sheds of the last wefts, and beat upwards. (See Step 5 and side & cross section views of 5a.)

Shift the left #2 finger only to the space between the **A** and **B** groups of warps to beat upward against the crossing wefts (**x**). (See side & cross section view of 5b.)

6. Slide left fingers #1 & #2 down into a comfortable position for picking

(Step 6), using your thumb to stabilize the warps above your left index, and your left middle finger to support the rest of the **A** warps (cross section view of Step 6). This 2-layer position is used for picking all subsequent rows. The first warp is pushed **DOWN** (at far right of the upper layer), the second warp is lifted **UP** (from far right of lower layer), etc.

Repeat steps 1 through 6 for the length of the warp, until there are only small concentric loops at the final end. Secure these together with yarn.

**UNWEAVING:** If you wish to unweave, find the shed of the last weft on one side, open the shed down to the end of the loops to separate yarns on opposite side. Uncross the **x** yarn, and repeat unweaving as far back as desired.

**TO FIND YOUR PLACE:** It is necessary to determine which side of the braid should be **UP**. With the braid flat, open the full shed at the last weft, with the **x** loop crossed. You will find that the numbers of loops above and below the crossed **x** loop are unequal. If necessary, turn the warp over so that the lesser number will be in the **lower** layer. When the crossed **x** yarn is added to this lower group, there will be an equal number of yarns in each layer, and the **A** yarns are on the right. You may then proceed as before.

### TWILL BRAID (2/2)

This braid tends to be thicker and narrower, with a beautiful chained edge. It is more interesting but is harder to do. As shown in Fig. 3, the warps *float* over or under two wefts, except in the center, where they interlace 3/3.

For your first sample of the twill braid, try 12 loops in 3 colors, 4L, 4M, 4D. Later, you might like to try 16 loops (2W, 4M, 6D & 4L) or even 32 loops (3 green, 3 red, 6 black & 20 white). The method is very similar to the above, except for the picking.

**PRELIMINARIES.** Prepare the warp as before, with a hanger-loop. To pick the warps for the **first** row, arrange the **A** yarns side by side on your left index finger in the order in which they were wound.

### WEAVING THE BRAID

1. **Picking:** For the twill, you will pick by twos with the right index finger, starting over the first two, under the next two, etc. After the first row, keep your left index finger in the shed of the last weft, taking care to keep warps in order, in the 2-layer arrangement for picking, described before in Step 6.

In all of these subsequent rows, for each **pair of warps** picked down or up, one warp is from above the last weft, one is from below. (See Figure 6.) Put the first two warps **DOWN** under your

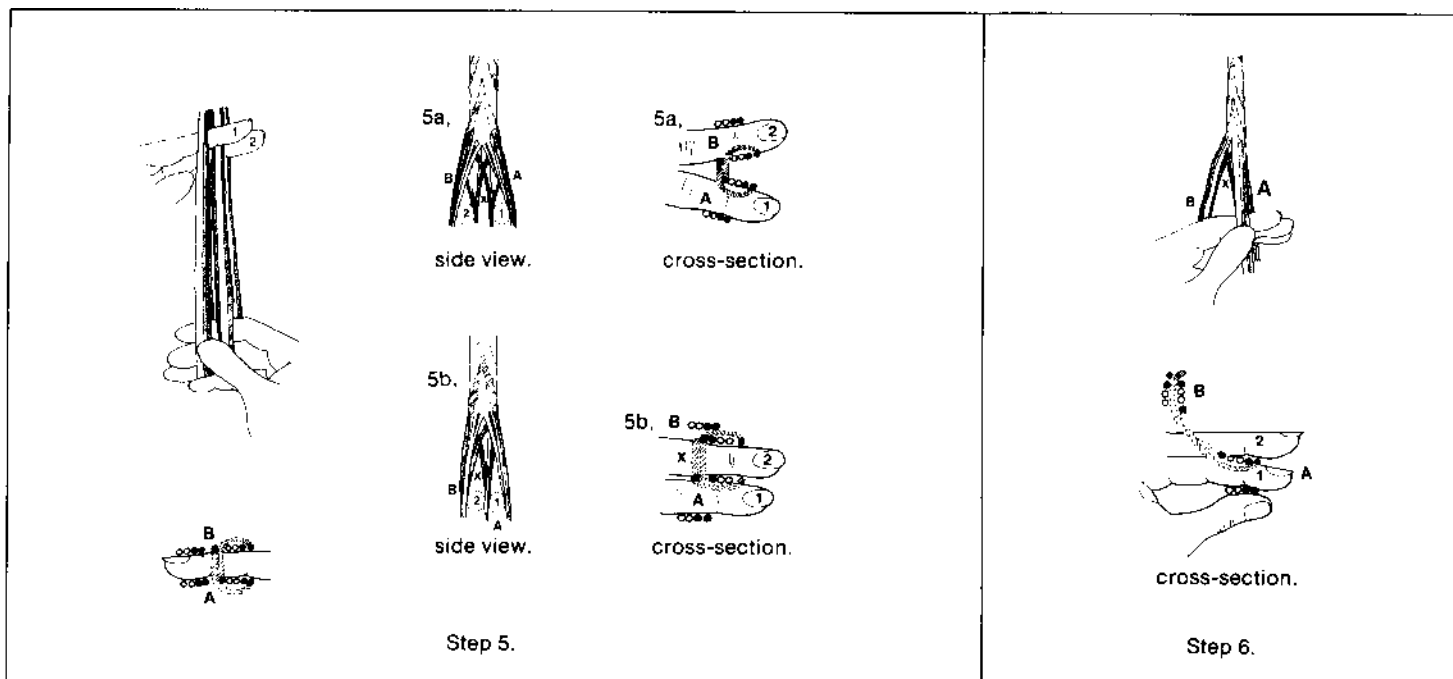

right index finger, the next two UP over the finger, and continue putting 2 down, 2 up, etc. Note that warp #2 will be found on top, floating over two wefts, and is to be put down with warp #1. When you lift up the next two, you will need to find warp #4 floating over two wefts underneath, to add it to warp #3 which is on top. Be sure to find the proper warps as you do the picking, especially #4 and #8, which tend to roll out of place.

2. Transfer picked (upper) A warps to left fingers, putting right fingers under the dropped alternate pairs of A warps. Slide both hands down to the ends of the loops, opening the shed. Pull taut, stretching arms apart, to open shed of B warps also.

3. Pull warp loops toward you, and with the left index finger, grasp warp x at the far right, below the turn of the last weft, coming down from the chain effect on the edge (Fig. 7). Hold warp x between the groups of warps.

4. With your right fingers still in their loops, reach under the lower part of the warp x loop, adding it to the warps on your right hand. When the top half of the loop drops, a figure-8 will be formed.

5. Temporarily transfer all loops from your left hand, putting them to the left of the loops on your right fingers, and hold all loops taut. Beat upward as described before for Steps 5a and 5b, ending with left middle finger beating up the crossing wefts.

6. Slide left fingers down into the 2-layer position for picking, described before in Step 6.

Repeat steps 1 through 6 for the length of the warp, as before.

Both braids can be considered "warp-faced", with the outside strands of "warp" used as the concealed "weft" for each new pick, then becoming "warps" again in the center of the braid. The outward-trending course of the visible elements (when not monochromatic) provides the chevron pattern for these braids. Although the front and back sides of the braids are almost identical, there is a noticeable difference down the thinner center of the twill braid.

## USES

Braids have many uses besides being used for bag straps. Robin wrapped the uncut endloops with yarn for a handsome belt. By inserting a matching tiecord into the wrapped loops, he had an attractive way to fasten the belt.

NOTE: When not to be covered by wrapping or figure-8 stitches, the loose ends of the beginning knots may be threaded into the eye of a needle to be concealed in the braid—and the ends trimmed.

Figures 2, 3, 5 & 6 by the author, all remaining drawings by Sue Baizerman.

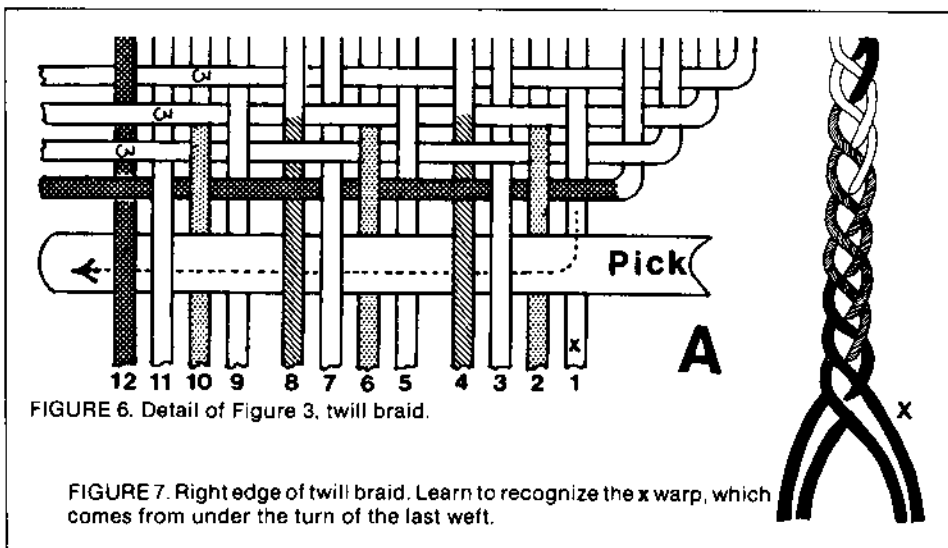

FIGURE 6. Detail of Figure 3, twill braid.

FIGURE 7. Right edge of twill braid. Learn to recognize the x warp, which comes from under the turn of the last weft.



Photo 1. Wool is sold or bartered in the provincial capital market, only a 2-hour bus ride from Cañar, Azuay Province, Ecuador.

Photo 2. Cañari women spin wool by the time-honored drop spindle. Cañar, Azuay Province, Ecuador.



photos by Charlotte Coffman

## BACKSTRAP

Cañar is located in the southern highlands of Ecuador. This quiet, dusty town of 5,000 was once the center of a highly developed culture. But by the late 15th Century, the Inca highway stretched past Cañar and the old society gave way to Inca rule. Nearby ruins at Ingapirca verify the Inca Conquest; little remains of the older Cañari excellence.

In 1949, traveler Victor Wolfgang von Hagen described one of the surviving attractions as the "jail, filled each market day with drunken Cañari prolonging, on the cold stone floor, their weekly debauch." Thirty years later I spent time in that same jail—to observe backstrap weaving!

Señor Aurelio Amoroso, director of the institution, obligingly unlocked the heavy iron gate and ushered me into the enclosed courtyard. Eight men were at work. Some wove ponchos; others wove *fajas* (belts). All used backstrap looms they had made or inherited. A few inmates offered miscellaneous loom parts for sale. Before regaining my freedom I would buy two wooden swords or battens, highly polished and stained dark from years of use.

The most common handloomed product is the wool poncho. In addition to the obvious practicality of a warm garment, the poncho indicates one's social status. Favorite designs are single off-center stripes, a dark stripe on a lighter background. These plain weave patterns are determined by the warping sequence. Natural colors predominate although I witnessed one poncho of demanding pinks and greens.

A continuous warp of tightly spun wool is transferred from the warping board to the loom. It extends approximately 30 in. (76 cm) from the warp roll bar, attached to the wall or vertical poles, to the waist bar, attached to the weaver by a leather backstrap.

# WEAVING FOR PENANCE AND PROFIT

by Charlotte Coffman

Continuous string heddles are looped under alternate warp threads. When supported and lifted by an attached heddle rod, the first shed is formed. The second shed is created by a round, wooden shed roll. Opening of these sheds is facilitated by the strummer, a short instrument with a dull point.

A sharp, slender shuttle carries the weft which is beaten in place by the sword. As weaving progresses the warp is rotated around the warp roll and waist bars. The completed work slides under the waist bar and climbs toward the warp roll bar. The unwoven warp moves toward the weaver. Less and less working space is available as the poncho nears completion. Smaller shed rolls and swords must be used until the last few wefts are inserted with a needle. Two woven pieces, 25-35 in. wide, are joined to make one poncho. Anyone interested in detailed instructions for weaving ponchos is referred to *Backstrap Weaving of Northern Ecuador* by Redwood (1974).

The most extraordinary are the tightly



Photo 3. Inmates weave wool ponchos on backstrap looms in the municipal jail. Cañar, Azuay Province, Ecuador.



Photo 6. Heddle arrangement for complementary warp pattern. Cañar, Azuay Province.

woven, warp-faced cotton belts. They measure 2-2½ (5-6½ cm) by 100-120 in. (2.5-3 m). A series of double-faced designs form a central column bordered by narrow stripes. Designs vary from stylized animals to modern trains and the provoking words, "en carcel" (literally, "in jail"). Black and white are commonly used but color choice depends on personal taste and thread availability.

The complicated complementary warp pattern (Emery, 1966; Rowe, 1977) develops from two sets of warp of contrasting colors. These elements play equal but opposite roles. When one warp set passes over the weft the second warp set passes under and vice versa. In this case, the black warp floats alternately over three and under one weft element (3/1) on one side of the belt while the corresponding white warp floats 3/1 on the opposite side of the belt. If uninterrupted, this pattern results in a reversible fabric, black on one side and white on the other.

The Cañari create designs by interchanging the color floats. These color exchanges are accomplished by floating the warp over two weft shots. The warp interlaces with the weft on one

face of the fabric according to the following sequence: over three, under one, over two, under three, and over one (Fig. 1). At the "over two" point that particular warp moves to the opposite face of the belt. Thus a double-faced fabric is woven with identical designs on each face, but the colors are reversed.

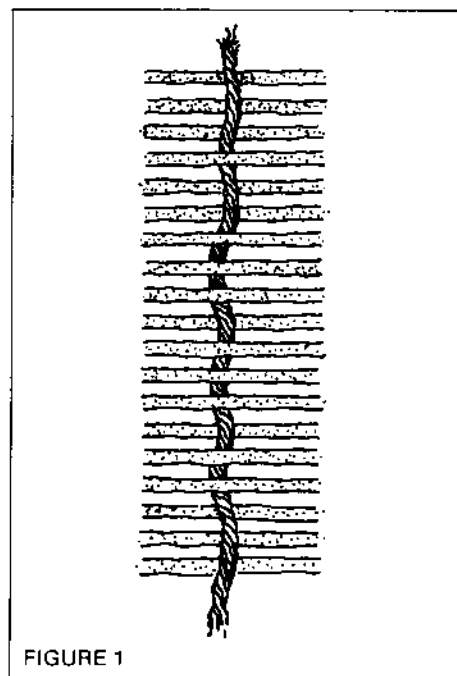

FIGURE 1

Belt construction by this method is not easily learned. Señor Mariano Duy was one of two weavers capable of demonstrating this technique. He good-naturedly offered to teach me—after I had purchased two of his belts.

I complimented Señor Amoroso on the success of his rehabilitation program. "It isn't a special program," he replied, "they weave to support their families." He explained that most local men know some weaving but under different circumstances choose other work.

Heading for the bus stop my mind questioned the director's words. How could reluctant, unpracticed hands weave such fine belts? As if in clarification a man's voice addressed me. "Ah, senora, you've been to our jail," he said, indicating my purchases. In confidential tones he admitted that he, too, had once been a weaver—while serving his jail sentence. And now? No, he doesn't weave anymore but he still owns a loom. "It makes a good weapon," he joked, gesturing forcibly with my heavy batten and leaving me to marvel at the versatility of the backstrap loom.



Photo 4. Warp-faced, cotton fajas (belts) are woven on narrow backstrap looms. Sale of these items allows the inmates to support their families. Cañar, Azuay Province, Ecuador.

Photo 5. A double-faced belt with complementary warp pattern. Designs are identical on both fabric faces but the colors are reversed. Woven by Mariano Duy. Cañar Azuay Province, Ecuador.



## References

- Emery, Irene. 1966. *The Primary Structures of Fabric: An Illustrated Classification*. The Textile Museum, Washington, D.C. p. 150.
- Redwood, Jane. 1974. *Backstrap Weaving of Northern Ecuador*.
- Rowe, Anne P. 1977. *Warp-patterned Weaves of the Andes*. The Textile Museum, Washington, D.C. p. 67, 73.
- Von Hagen, Victor W. 1949. *Ecuador and the Galapagos Islands*, 1st. ed. University of Oklahoma Press, Norman, Oklahoma. p. 66.

Charlotte Coffman became interested in the backstrap loom when she spent a year and a half in Mexico. She is married and her husband's work in international agriculture required them to live abroad and to do extensive traveling. For nine years they lived in the Philippines. She is

now back in the US but she is continuing to research the backstrap looms, natural fibers and ethnic designs. Charlotte Coffman will write a follow-up article for *The Weaver's Journal* explaining how she weaves belts such as she saw being woven by the Canari. 

## JACOB ANGSTADT DESIGNS

*Jacob Angstadt*  
His Weavers Pattern Book

*Jacob Angstadt Designs*  
Drawn from  
His Weavers Pattern Book

### TWO BOOKS REVEAL 18th CENTURY MASTER WEAVER'S RECORDS

A photographic replica of Jacob Angstadt's pattern book: 307 coverlet and tablecloth drafts; 237 tie-ups for point twill drafts on 6, 8, 12, 16, 20, 24, 28 and 32 shafts. Companion book contains nearly 500 drawdowns from the profile drafts and point twill tie-ups. Designs adaptable to unit weaves on 5 to 10 shafts. Prepared by Ruth N. Holroyd with Ulrike L. Beck. 8 1/2 x 11" Hardbound set totaling 400 pages. \$39.95 per set\*

Published & Distributed by:

Ruth N. Holroyd  
20 Old Farm Circle  
Pittsford, N.Y. 14534 U.S.A.

Add \$2.00 Postage & Packaging (\$3.00 overseas) per set—\*N.Y. State Residents add 7% tax. - Dealer inquiries invited.

NOW AVAILABLE!

Seminar or Workshop: "Playing with Profiles", Interchanging unit weave systems within multi-harness profiles. Inquire. Ruth N. Holroyd, Instructor

## Weave Rugs EASILY AT HOME



### MAKE GOOD PROFITS!

Fascinating full or spare time home business. YOU can weave beautiful, serviceable rugs on low cost floor model loom that comes threaded, ready to weave - including accessories! Just a few days weaving pays cost of loom. For complete catalog, sample card and low prices on warps and supplies - send 25¢. If you have loom - advise make and weaving width please.

OR. RUG CO., Dept. 4275, Lima, Ohio 45802



# BOOK REVIEWS

*THE COMFORTABLE ARTS* by Dorothy K. Burnham © 1981 National Gallery of Canada. Published by National Museums of Canada, Order Fulfillment, Ottawa, Ontario K1A 0M8, Canada. 238 pp., \$19.95 Canada, \$24.95 U.S. ISBN #0-88884-474-3.

The National Gallery deserves all our appreciation for organizing this important show of Canadian textile crafts which is titled "The Comfortable Arts". So far, I have not been fortunate enough to see the show but it will open in Vancouver on May 25th '82 and remain there two to three months. It will be in Vancouver when *Convergence* is in Seattle. However I am very grateful to own this book by Dorothy K. Burnham which has the same title and is subtitled "Traditional Spinning and Weaving in Canada". The book serves as an illustrated catalogue and commentary on the show but is an important publication in its own right. Each textile is reproduced through large and excellent black and white photographs which clearly reveal the aesthetic qualities of the objects depicted. The comments which accompany each piece give a lot of information on the materials, the technique, the historical and geographical background and on the philosophy of the Canadian artisan towards his craft.

The clear line drawings of the interacements of the threads, for each one of the techniques used, makes this book a very valuable reference for fiber structures.

The content of the book is organized with a great deal of logic which makes it easy for the reader to find specific textile items and to put them in the right perspective with regard to Canada's large geographic expanse and multi-cultural background.

The range of material is wide although it is basically limited to cloth which has been constructed by means of looping, plaiting, knitting, weaving and twining. After a brief introduction describing these basic structures the book is divided into several chapters, each one being related to a particular textile tradition. The traditions of the native people include work done by means of looping, plaiting, twining, weaving, beading, quill work. Native people and the French both contributed to the tradition of fingerwoven bands and sashes. The chapter on traditional French weaving shows, among others, beautiful examples of "catalogne" (Rag weaving), a long-eyed heddle technique called "à la planche" and a nice selection of garments.

The book contains good examples of coverlets in Overshot, Summer and Winter, Double-weave, Fancy twills and Jacquard patterning. The rich cultural background of Canada is also illustrated through costumes, tapestry and knitting.

Dorothy Burnham's skills in publishing well-researched documentation on textiles and enhancing it with an appealing layout and excellent photographs is evident throughout this book.

Clotilde Barrett

*HOW TO WEAVE FINE CLOTH* by James D. Scarlett © 1981 by Reston Publishing Co., Inc., Reston, VA 22090. Hardcover, 204 pp., \$14.95, ISBN #0-8359-2987-6.

The purpose of the book is to give help to the weaver whose aim it is to make good cloth. The author accomplishes this and much more. He himself is a weaver and makes cloth for his own use and for sale. His own specialty is tartans of which the weaving is simple but very exacting. He gives details on all the steps involved in the production of cloth and reveals methods that work particularly well for him. He also offers alternative approaches so that the weaver can find a way which suits her/him best.

The first chapter is about looms and how they differ from each other. Included here are different ways of attaching the warp to the beams, a section on friction brakes and shedding mechanisms. The author discusses shuttles, warping devices, templates and an array of interesting equipment which can be built and adapted by the handweaver.

There are good descriptions of production aids such as the witch, the dobbie, the jack-in-the-box and the flying shuttle.

The section on yarns which includes the principles of yarn counts ends Part I of the book.

Part II deals with techniques: how to make a warp, how to beam it, how to tie up the loom, how to start weaving, how to weave off the goods, how to finish cloth and how to take care of mistakes.

Part III has a short section on drafting and is also a catch-all for all the useful information about weaving that the author wants to share. There is an interesting chapter on tartans and other color-and-weave effects, a chapter on knots and cords and other things which the weaver should know such as the care of a loom and other helps and hints.

The author has included the drawings of his own loom and his warping frame.

This book is highly recommended for those who want a better understanding of all the technical aspects of the craft of weaving and thereby improve their skills.

Clotilde Barrett

*THE WEAVERS DRAFT BOOK AND CLOTHIERS ASSISTANT* by John Hargrove. Facsimile published by the American Antiquarian Society (1979), 185 Salisbury St. Worcester, MA 01609, 30 pp., \$4.50

This 30 page booklet first published in 1792 is now republished with an 11-page introduction by Rita J. Adrosko.

The old drafts of the facsimile are easy to read and to understand: 18 designs for 4 shafts, 3 for 5 shafts, 23 for 6 shafts, 3 for 8 shafts and 5 for 10 shafts. They are of historical significance and can be used by today's weaver for yardage.

However, it is the comments of Rita Adrosko which makes this booklet so interesting. She has researched the life of the author, the textile manufacturing in Maryland at the time the book was written and has good information on drafts and draft books dating back to early American weaving.

I was delighted with this publication and I am sure others will be as well.

Clotilde Barrett

*THE COMPLETE ENCYCLOPEDIA OF NEEDLEWORK* by Therese de Dillmont © 1978. Published by Running Press, 125 South 22nd St. Philadelphia, PA 19103, 700 pp. \$7.95 + .75 P/H.

This text, originally written in French, was first published around the turn of the century. Ever since, it has been the good old stand-by for anyone wanting to do or collect needlework. To the best of my knowledge, the text has remained the same as in the earlier editions of this book but this second edition published by Running Press has larger print and illustrations which make the book more readable. The contents include: plain and machine sewing, mending, various types of embroidery, applique work, tapestry, knitting, crochet, tatting, macrame, lace, needlework trimmings and ornamentation. The subjects are dealt with exhaustively with detailed descriptions and clear illustrations.

It is a very comprehensive book and shows beautiful examples of needlework which was popular in the early 1900's. This book is old-fashioned but will remain a valuable reference for needleworkers at all times.

Clotilde Barrett

*A HISTORY OF TEXTILE ART* by Agnes Geijer © 1979, Agnes Geijer. Published by The Pasold Research Fund Ltd. in association with Sotheby Parke Bernet Publications. In U.S.A. available from Biblio Distribution Center, 81 Adams Drive, Totowa, NJ 07512. Hardcover, 317 pp. plus 293 B/W photos and 4 in color. ISBN #0-85667-055-3.

This book is a revised translation of the Swedish text *Ur Textilkonstens Historia* published in 1972.

The first chapter is on fibers. The common fibers used in historical textiles are described in terms of their physical properties and cultivation. Some historical background is given. Next is a chapter on weaving implements which deals with many types of looms. The author discusses how they work and how they were and are used in different periods and geographical areas.

There is a classification of weave structures and some weaving techniques are explained. However, this serves merely as a guide to help in the identification of historical textiles and is not a comprehensive analysis of interlacements.

In the following chapters the author evaluates the many aspects of textile arts and traces

their development, geographical distribution and the interactions during their evolution. Looms, fibers, patterns, and weave structures are studied and related to probable historical periods.

The text is scholarly but not stilted. The reader learns about weaving techniques and equipment and can relate them to historical periods and to real textiles which have been preserved for centuries.

The historical period dealt with in this book dates back to the earliest textile fragments which have been documented. The main geographical areas are Europe and Asia with a great deal of emphasis on Scandinavia. An entire chapter is devoted to the textiles and textile crafts in the Scandinavian countries.

The book is well illustrated with line drawings within the text and with a section of B/W photographs which contains over 200 illustrations.

Clotilde Barrett

**REPRINTS OF BETTE HOCHBERG'S TEXTILE ARTICLES** © 1982, self published, 333 Wilkes Circle, Santa Cruz, CA 95060. 16 articles, 34 pp., \$4.95. ISBN #0-9600990-7-7.

Betty Hochberg has amassed a lot of information on fiber, spinning and weaving as she thoroughly researches various aspects of that field. During the last four years she has shared her vast knowledge through several self-published booklets and through articles in various magazines and other publications. These different periodicals may be hard to get or unavailable by now and therefore it was wise of her to republish these 16 articles under one cover. Most are about spinning, including the use of high whorl and bead whorl spindles, carders and hand-held distaffs. There are recommendations for better control over handspun yarns. Other articles are of social and historical interest.

Spinners will appreciate this edition because it will relieve them from hunting for and borrowing old magazines to be able to read these interesting articles.

Clotilde Barrett

**TASSELS** by Doris Hoover and Nancy Welch © 1978. Self-published by Apple Tree Lane, 3505 Evergreen Dr., Palo Alto, CA 94303. 50 pp. ISBN #0-9601-602-0-5.

There is a true need for more publications on trims and embellishments for textiles. Therefore we welcome this third printing of a small book on tassels. We only wish it was bigger!

The authors convey their great enthusiasm of searching for, discovering and being delighted by tassels. This very versatile textile ornament is part of our history, our folklore and is often of special significance to the culture of its makers.

The how-to-do-it section of the book shows how to make basic tassels and pompoms. It also gives instructions for variations and for certain embellishments. The possibilities are endless.

The authors give suggestions for the use of tassels but, better yet, there are many pages of illustrations of old and new tassels which will truly inspire anyone to brighten their environment by either collecting or making tassels.

Clotilde Barrett

**THE ART OF WEAVING** by Else Regensteiner © 1970. Second edition published by Van Nostrand Reinhold Co. Hardcover, 192 pp., \$18.95. ISBN #0-442-27571-4.

This publication is the second (revised and enlarged) edition of a favorite basic textbook on weaving. It is rightly recommended by many college teachers as a study and reference book. Not only does this book contain an abundance of valuable information but it is also well illustrated with line drawings and excellent photos of close-up of weaves, of equipment, of yarns and of finished projects. The layout of the book is attractive and the weaving projects are inspiring. Furthermore, there are 12 pages of color plates which brighten the textbook.

The content will provide the beginner weaver with plenty of information for many years of growth and will remain a good reference for those who have acquired the basic skills. The author deals with weaver's equipment in a concise but comprehensive manner and includes a good section of fibers and yarns. Instructions for both plain and sectional warping are given. The drafting of weaves is clearly explained and this section is followed by a study of the variations of plain weave and twills (4 and more shafts).

What I like most about the book are the many suggestions for using color in both warp and weft and to produce creative fabrics based on well used drafts.

What I like least is a lack of established relationship between weaves. Summer and Winter, Honeycomb, M and O patterning, and Swedish Lace follow each other without apparent logic.

The chapter on multi-layered cloth is very good and goes beyond the scope of a basic textbook. Rugs and tapestry techniques are sketchy but there is enough information to realize very interesting projects.

The chapters on design, wallhangings and collecting and preserving textiles are very informative and will justify the word "Art" in the title of the book.

The appendices should not be overlooked as they contain some of the most useful information for the weaver who is faced with such annoying little problems as broken warp threads.

We welcome this new edition as this fine book should never go out of print and should remain updated to inspire the contemporary weaver.

Clotilde Barrett

**COMFORT CLOTHES** by Chris Rose © 1981. Published by Celestial Arts, 231 Adrian Rd., Millbrae, CA 94030. 80 pp., \$7.95. ISBN #0-89087-321-7.

This book is subtitled: Easy to Make and Easy to Wear West African Garments for Everyone. The patterns in this book lend themselves well to the use of handwoven yardage. They are all representative of those worn daily in most contemporary West African countries.

Each chapter of the book deals with a group of related garments: Caftans, wrapped garments, regional garments, men's garments. The last chapter is about fabric embellishments and deals with dye techniques and embroidery.

The general sewing information, the measurement chart and the neck opening templates are very useful to the designer of handwoven garments.

The instructions for each garment are complete with good illustrations, patterns drawn to scale, fabric needed and cutting and sewing instructions.

Weavers are always on the lookout for easy-to-sew and no-waste patterns which are comfortable and stylish. In this book they will find new inspiration and good instructions.

Clotilde Barrett

**NORWEGIAN DOUBLE WEAVE PICK-UP, DIRECTIONS AND DESIGNS** by Helen Brewer © 1981, self-published, Handweaver Shop, 340 Coventry Rd., Virginia Beach, VA 23462, 4 pp., \$4.00.

This publication comes as a binder, holding notes of a specific double weave pick-up technique. According to the author the method is taught in Norway. It differs from the ones found in most weaving publications. The design is drawn on graph paper in which each square is counted as 1 thread (of a single layer) and not the crossing of two warp ends and two weft picks as in most techniques. More detail and smoother lines can thus be woven with the Norwegian method. The technique is well described and the text is easy to follow if one remembers that the sett is given for one layer and thus has to be multiplied by two.

There are some designs, suggestions for yarns and setts.

This is a useful publication for the fanciers of double weave pick-up.

Clotilde Barrett

#### FOREIGN PERIODICALS

*The Weaver's Journal plans to review all the foreign periodicals and newsletters which are of special interest to the textile artist and/or handweaver, dyer and spinner. Due to language barriers and some lack in communication, this list of foreign periodicals cannot be complete but we will mention each and every one which is sent to us. In this issue we will cover as many as possible in the following languages: German, Scandinavian languages, Netherlands (Dutch), Spanish. We plan to continue in the next issues of The Weaver's Journal.*

**KUNST & HANDWERK** (Arts & Crafts). Published monthly by Verlagsanstalt Handwerk GmbH, Postfach 8120, D4000 Dusseldorf 1, West Germany. Overseas annual subscriptions, DM 115 (\$52.60); includes P & H.

The simplest way to describe this magazine is to translate the publisher's "blurb" from the subscription form:

"K & H reports on all fields of applied and decorative art: Ceramics / Goldsmithing / Jewelry / Tapestry / Faience / Bookbinding / Stone Sculpture / Pewter / Tile Stove / Construction / Woodcarving / Art Metalworking / Weaving & Textiles / Art Glassworking / Basketry / Batik / Art Photography / Interior Design / Wood Turning / Art in Construction / Folk Art / Furniture.

# Use this easy way to shop for books that matter.

## Weave It 28 Projects for Your Home

**Marilyn Meltzer.** Complete with original weaving projects contributed by experts, this manual is devoted to the crafting of functional and decorative items. You'll find step-by-step instructions on how to make an afghan... lampshades... a rug, runner, and stair treads... and more. Also included are general weaving directions, materials, and lists of suppliers. *96 pages, 8 3/4 x 11 1/4, 40 illustrations, 300 line drawings, \$14.95*

## Weaving as an Art Form A Personal Statement

**Theo Moorman.** Top textile artist Theo Moorman describes in detail the weaving technique that bears her name. She also offers concrete guidelines on producing commissioned designs... weaving and mounting three-dimensional hangings... and dealing with many other practical and aesthetic questions. *"Delightful and exciting."* — *THE WEAVERS WORLD*. *104 pages, 6 x 9, 54 illustrations, \$6.95 paper*

## Weaving Techniques for the Multiple- Harness Loom

**Pierre Ryall.** A distinguished French weaver, teacher, and author guides the reader through an extensive analysis of pattern drafting on 4, 6, 8, 10- and 12 harnesses. Ryall discusses taste and color choice, color effects of weft crossing warp, and many creative and technical elements. Hundreds of clear diagrams included. *480 pages, 5 x 7, hundreds of pattern drafts, \$9.95 paper*

## The Art of Weaving Second Edition

**Else Regensteiner.** Famed weaver Else Regensteiner has completely revised her popular guide to the art of weaving. The Second Edition features 100 new photographs and line drawings in addition to those that made the first edition the weaver's bible. She covers weaving with a backstrap loom... estimating yardage for warp and weft... reading a draft... and other key aspects of weaving. *192 pages, 8 1/2 x 11, 168 line drawings, 332 photographs, \$18.95*

"A needed and most welcome exemplification of a somewhat neglected design technique."

— *Shuttle, Spindle & Dyepot*

## Color-and-Weave

**Margaret and Thomas Windeknecht.** By applying the color-and-weave principles found here your ideas can easily be translated into beautiful pieces of art. Explicit instructions and abundant photographs and drafts reveal a wide range of patterns that can be created by using dark and light threads in both warp and weft. You'll find a broad selection of threadings, including patterns for two-, four-, and eight-harness looms. Margaret and Thomas Windeknecht — the former a renowned creator and teacher of fiber techniques — cover patterns such as plain weave, twill, log cabin and shadow weave and warp- and weft-faced weaves. You get 900 pattern variations in all! *192 pages, 8 1/2 x 11, 900 illustrations, \$22.95*

## Weaving Tricks

**Susan Gilmurray.** Turn to this stimulating volume for down-to-earth guidance on all aspects of the weaver's craft. The author discusses various cloths and weaves and offers advice on loom selection as well as studio design. You get essential information on fibers, knots, yarns, and much more. *"Truly a useful book."* — *THE WEAVER'S JOURNAL*. *128 pages, 6 x 9, 136 line drawings, \$12.95*

## Oriental Rugs Care and Repair

**Majid Amini.** One of the few skilled repairers and restorers of oriental rugs working in Europe and the U.S. today, provides clear, practical techniques for choosing and caring for an oriental rug. You'll find basic principles of selecting a rug for a particular room plus tips on wise buying in the current market. Step-by-step techniques are featured for general cleaning, stain removal, transportation, and storage. The author also gives you valuable advice on valuation, insurance, and re-sale of oriental rugs. *128 pages, 7 1/4 x 11 1/4, 65 photographs, 80 line drawings, \$19.95*

## The Art Fabric Mainstream

**Mildred Constantine and Jack Lenor Larsen.** Carries the visual history of the Art Fabric movement through the 1970's. Lavish photographs reveal ventures into previously unexplored realms of shape, texture, scale, materials, and forms. *"Will be the standard reference on the 70's."* — *FIBERARTS*. *240 pages, 10 x 13 1/4, over 320 color and b/w illustrations, \$39.95*

## Warp/Weft/Sett A Reference Manual for Handweavers

**June H. Beveridge.** Select the best warp-weft:sett combinations! You'll find here 944 life-size photographs of samples — each using common reed sizes and the most popular cotton and linen warps. Also included is extensive information on yarn systems, calculations, and yarn supplies. *"Should save weavers from the time-consuming task of sample-making."* — *LIBRARY JOURNAL*. *191 pages, 8 1/2 x 11, 944 photographs, \$22.95 cloth*

## Handspinning Art and Technique

**Allen Fannin.** Explores the creative possibilities available in handspinning. You'll see how modern mill-spinning technology can be adapted to small-scale projects. Practical tips are provided to help you master basic skills. *208 pages, 7 x 10, 196 illustrations, \$9.95 paper*

## Spinning Wheel Building and Restoration

**Bud Kronenberg.** An expert woodworker shares with you his hard-won secrets — from how to dry lumber to how to produce authentic reproductions of working spinning wheels. You'll find valuable information on the kinds of wood used, the function of each part, and the special features of each wheel. Exact dimensions for all parts are supplied together with explicit step-by-step instructions for making and assembling them. You'll see how to make spinning accessories and restore antique wheels. *"Fulfills the woodworker's need for guidance."* — *Shuttle, Spindle & Dyepot*. *143 pages, 8 1/2 x 11, 87 illustrations, 78 line drawings, \$18.95*

AVAILABLE AT YOUR CRAFT SHOP, OR ORDER DIRECTLY FROM THE PUBLISHER



**VAN NOSTRAND REINHOLD  
Mail Order Service**

7625 Empire Drive, Florence, Kentucky 41042

Please send me the books checked for 15 days free examination. At the end of that time I will pay the purchase price plus small delivery and handling cost, or return the books and owe nothing.

Name \_\_\_\_\_

Address \_\_\_\_\_

City \_\_\_\_\_ State \_\_\_\_\_ Zip \_\_\_\_\_

(Offer good in U.S. only, and subject to credit department approval. Payment must accompany orders with P.O. box addresses.) Prices subject to change

23329-9 Color-And-Weave.....	\$22.95
— 27571-4 The Art of Weaving.....	\$18.95
26132-2 Weaving Tricks.....	\$12.95
26129-2 Warp-Weft-Sett.....	\$22.95
— 22541-5 Handspinning.....	paper \$9.95
— 21638-6 The Art Fabric.....	\$39.95
— 25326-5 Weave It.....	\$14.95
... 20174-5 Weaving as an Art Form.....	paper \$6.95
— 27085-2 Weaving.....	paper \$9.95
— 21915-6 Spinning Wheel.....	\$18.95
— 20864-2 Oriental Rugs.....	\$19.95

W7310

"K & H informs about all events on the artistic scene / about Arts and Crafts / about People / Ateliers / Competitions / Prizes / Shows / Galleries / Professional Schools.

"In K & H you find: Schedules of Important Shows / Survey of Developments in the Art Market / Reviews of Books on Art.

... and only a few ads."

It must be noted that not all of that impressive menu can be covered every month in a 32-page magazine! The text is entirely in German but the figure legends are in German, English, and French. No "how to" articles are included.

This journal is of some value to those who are interested in profiles of European (and some other) art/craft personalities, and events, but because only a fraction of its content deals with weaving, and because of the relatively high price per page, it probably is not a bargain for the handweaver.

Earl Barrett

**TEXTILKUNST** (Textile Art). Published quarterly by Verlag M. & H. Schaper, Grazer Strasse 20, Postfach 810669, D3000 Hannover 81, West Germany. Foreign subscriptions, DM 45.40 annually (\$19.65 at current exchange rates); this includes postage and handling.

This magazine is devoted mainly to articles on the work of specific textile artists. They contain biographical sketches, comments on the techniques used, and numerous photographs of the artist's work. Most illustrations are black-and-white, but both outside covers and some interior photos are in strong color. Other topics include: articles on specific techniques (but not of the how-to-do-it variety); reviews of shows and workshops; reports on textile-art education in Germany; book reviews (mainly German publications); announcements of coming events, mainly on the German scene, but some coverage of the rest of Europe and a very little of the U.S. (only one show for the entire quarter March-June!). No foreign-language summaries are provided, at least on a regular basis; a reading knowledge of German is needed for full appreciation of the content.

This journal will be of interest mainly to those who want to keep current on the trends in textile art and the activities of textile artists in Germany, Europe, and some other areas (Israel, Africa, etc.). It will not appeal strongly to the handweaver who is looking for do-it-yourself projects, but could serve as a source of inspiration to advanced textile artists who are masters of technique.

Earl Barrett

**WEBE MIT** ("Weave With", or perhaps better "Weave Along"). Published quarterly by Webe Mit-Verlag, D-7065 Winterbach-Manolzweiler, Federal Republic of Germany. Annual subscription, DM 19.- (\$8.50 at current exchange rate); foreign subscribers add DM 1.- (\$1.50) for P & H.

This "quarterly journal of handweaving", as it is subtitled, concentrates mainly on "how to" articles. Each article presents weaving instructions for one or more pieces by one author. The projects run the full gamut: Clothing, table coverings, bedcovers, wall-

hangings. Although various techniques are used for these projects, there is a definite bias in favor of the rigid-heddle loom.

In addition to these, there are articles that give overviews of techniques (sprang, bandweaving, fabric finishing, etc.). The magazine is rounded out by announcements and/or reviews of textile exhibitions in West Germany and neighboring countries, book reviews (some foreign), workshop and course announcements, and a "letters" department. There are no foreign-language articles or summaries.

This journal is relatively easy to read (assuming a fair reading knowledge of German), but is somewhat weak in visual aesthetics. All photographs are black and white (the front cover is monochrome) but in general are of good quality.

Earl Barrett

**HEIMATWERK** (Cottage Industry). Published quarterly by Verlag Schweizer Heimatwerk, Postfach 8023, Zurich, Switzerland. Foreign subscriptions, Sw. Fr. 16.- (\$8.75); this presumably includes P & H.

As the title and publisher's name suggests, this publication is devoted mainly to the arts and crafts of Switzerland. Its main appeal outside that country will be to Swiss expatriates who want to keep in touch with what is going on in the homeland in the art/craft field, and to educators or students of ethnic arts and crafts.

Most of the content of this 40-page quarterly is devoted to profiles of, or interviews with, German-Swiss artist-craft people who are engaged in production for the market. The articles are well-illustrated with high quality photos, mainly black and white. A few commentary articles and reviews of major European events in the art/craft world are to be found.

Earl Barrett

**LANDSFORENINGEN STOFFTRYKKEN—& VAEVER LAUGET** published by Birgit Olsen, G1 Kongevej 91C, sal, 1850 Copenhagen V, Denmark, is a newsletter-type periodical that keeps its readers informed on the events and classes related to weaving and textile surface design. There are various announcements of interest to weavers residing in Denmark. It might be worthwhile for a traveler to Denmark to get in touch with the publisher to find out what is going on during a certain period.

Clotilde Barrett

**HAANDARBEJDETS FREMME** published by the Danish Handcraft Guild. Danish/English text. Published as a membership magazine. 1 year subscription Dkr 125.00 (approximately \$40.00), includes airmail postage and 5% discount on cash purchases from the Guild. Write to: Sekskabet til Haandarbejdets Fremme Vimmelskafte 38, DK-1161, Copenhagen K, Denmark.

Although the Guild is a distributor for many craftspeople, its main interest continues to be the art of textiles. The magazine publishes mostly articles on needlework. Other textile handcrafts are discussed but more from historical and social viewpoints. In the single issue which was available to me there is no handweaving, spinning or dyeing.

Clotilde Barrett

**HEMSLOJDEN** published by Svenska Hemslojdsforeningarnas Riksförbund, Mellangatan 7B 62157 Visby, Sweden. Published 6 times per year in Swedish with an English summary. Subscription price: Skr 48 (approximately \$15.25).

This colorful and very attractive magazine is published by the national federation of the handcraft guilds of Sweden. The crafts include weaving, embroidery, woodwork, jewelry, ironwork, basketry, pottery, candle-making and others. Many of the craft items have the appeal of folk art and even the most contemporary pieces are often based on tradition. The purpose of this publication is to make the reader appreciate the crafts. It encourages hand crafting, it stimulates the handcraft industry and it shows how to enhance one's surroundings through the use of hand crafted items. Sometimes patterns, kits and instructions are available. However, most of the articles show and describe the products of the various handcraft guilds, including the price. The objects shown are beautifully designed and well crafted and are a true inspiration to those who practice the craft themselves and to those who want crafts to be part of their daily life.

Clotilde Barrett

**KOTITEOLLISUUS** Published by Kaj Nuorivaara, Tempelkatu 15 A 5, 00100 Helsinki 10, Finland. Published 6 times per year, in Finnish. One year subscription 82 mk (approximately \$17.76) to be mailed to: mi Markkinoite Elo, Papinmaentie 18, 00630 Helsinki 63, Finland.

Although this publication is entirely in Finnish, a language of which the meaning of the words cannot even be guessed at by most of us, this magazine is one of the most popular of the foreign periodicals. The photographs, especially the color photographs of woven projects and of woven cloth speak a visual language that will be enjoyed by all. The photos are so good, it is almost like having the real thing in your hands. The description of the woven swatches are so logical and accompanied by standard drafts that it does not take long to identify key words such as warp (loimi), weft (kude), sett (tiheys), pattern (sidos), sley (pirta). The yarn count is given in the tex-system. The only words which require a dictionary are the type of yarns used and the colors, but as Scandinavians weave with a rather limited variety of yarns (mostly cotton, linen, wool), this vocabulary should not be hard to pick up. The photographs reveal the colors.

The publication contains also many knitting patterns, some needlework, instructions to make various components of the Finnish costumes. There are some articles about the homecraft industry in Finland.

I don't read Finnish but I am always delighted to find Kotiteollisuus in my mailbox. I find the weaving patterns very inspiring and easy to understand.

Clotilde Barrett

**GOED HANDWERK** published by Stichting Goed Handwerk, Laan van Meerdervoort 300A, 2563 Al Den Haag, Holland. Published 5 times per year in Dutch. 1982 subscription is f21.50 plus a f3.50 membership fee (f21.50 equals approximately \$8.44).

The articles and information in this periodical are geared to the homemaker who is concerned with the tradition, the development and the creation of well crafted textiles. Two areas of textile crafts are emphasized. First, lacemaking; grouped with this is embroidery, macrame, quilting, batik and others. Second, loom weaving. There is also an increasing interest in spinning and dyeing. Some articles discuss technical approaches to textiles but the magazine is more a means of distribution of information and establishing communication between various study groups.

There is a lot of information on classes, shows, available periodicals and books.

The reports on shows and exhibits show a great appreciation for well-crafted historical textiles but also for good art weaving and functional textiles which are being done today, not just in Holland but, to the extent that it is possible, on an international scale.

The center pages are tear-out sheets and function as a newsletter for the handweavers

of Holland and the northern provinces of Belgium. National and regional meetings and events are announced. There is a department set aside for reviews, questions and answers, weaving tips and other information which one weaver or an entire study group wishes to communicate.

Even if one does not read Dutch, this periodical will be of interest to the bobbin lace fanciers and to those lucky enough who spend time in Holland.

Clotilde Barrett

**TEXTILES PARA EL HOGAR** (Textiles for the Home). Published bi-monthly by Publica S.A., C/ Travesera de las Cortes, 354, entresuelo, Barcelona 29, Spain. Annual subscription, \$55.00.

As the name implies, this very slick magazine is oriented toward interior designers and is mainly concerned with the commercial textile industry. The articles include such topics as:

Reviews of textile trade fairs; trends in textiles for interior designers (patterns, schemes, etc.); the economic problems of the Spanish textile industry; profiles of individual commercial-textile designers; and similar subjects. Some "How-to-do-it" articles do appear, but the average is less than one per issue. A sizeable fraction of the pages is occupied by large display advertisements in excellent color for finished fabrics such as draperies, carpeting, bedspreads, etc. Summaries of some of the articles in English, French, or German appear sporadically; again not in every issue.

The visual impact of the magazine is very strong, but apart from the information thus conveyed about the quality of Spanish textiles, it does not have much to offer the handweaver in exchange for the rather high price. It will, however, be of interest to American designers of commercial fabrics. It can only be appreciated fully, however, by those having a good reading knowledge of Spanish.

Earl Barrett



**DOS TEJEDORAS**

NOW AVAILABLE IN U.S.: **NIGERIAN HAND-CRAFTED TEXTILES**, J. Eicher. Traditional dyeing & handweaving. Nigeria. \$15 paper, \$20 hard cover.

**NEW: LATVIAN MITTENS** by L. Uptis with color photos and over 100 graphs: \$19.50 paper.

**PATTERNS AND TEXTURES FOR THE RIGID HEDDLE LOOM**, B. Davenport \$5.95 paper.

**FINISHES IN THE ETHNIC TRADITION**, Baizerman & Searle \$6.50 paper.

**LATIN AMERICAN BROCADES**, Baizerman & Searle. \$4.50 paper.

Postage and handling: \$2.00 for first book and for each add'l.

Send orders to: Ramus, 300 North Snelling Ave., St. Paul, Minnesota 55112, U.S.A.



**Weavers' Loft**

*Intensive classes in weaving.*

Instruction on Swedish looms by internationally known Swedish weaver, Lilly Bohlin. All aspects of weaving are explored as well as spinning and design. Glimakra and Lillstina looms and Scandinavian yarns for sale.

Lilly Bohlin Handweaving School and Studio  
1021 Government Street  
Victoria, British Columbia V8W 1X6  
Tel: (604) 388-6306

**LOOM REEDS**

QUALITY REEDS FOR OVER 50 YEARS

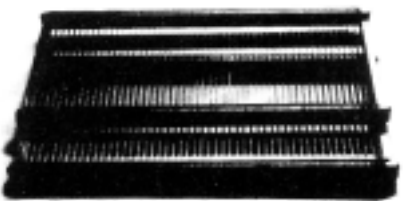

Made to your specifications, any dents per inch, lengths and widths.

Write for price list:  
**BRADSHAW MANUFACTURING CO.**  
P.O. Box 425  
West Columbia, S.C. 29171 USA  
(803) 794-1151

**ORDER ALL YOUR WEAVING, SPINNING, DYEING BOOKS AT DISCOUNT**

Any good, standard Classics and many New Titles  
Also Needlework, Hobbies, Crafts, Dolls, Miniatures  
10% discount on any U.S. books

**KATHERINE RAMUS      2100 E. EASTMAN AVE.,      ENGLEWOOD, CO 80110**

# PRODUCT REVIEWS

## WEAVER II

Weaver II is a revised and improved version of the Weaver program that was described in the article "Computer Weaving" in the January 1980 issue of *The Weaver's Journal*. It requires an Apple II or II Plus with 48K RAM, Applesoft in ROM (but Integer users are not totally neglected), and one disk drive; a printer is optional. Disks can be either 13-sector (DOS 3.2) or 16-sector (DOS 3.3) as ordered. The program is obtainable from: Bruce Bohannon, 2212 Pine St., Boulder, CO 80302. Price to single users is \$50.00; schools and clubs may purchase duplication rights for \$100.00 and make copies for their classes or members. Add \$2.00 for P&H.

The program is menu-driven; items are selected by typing the name (or just the initial letter in most cases) rather than an item number. From the main menu one selects sub-menus which permit retrieving weave data and drawdowns previously stored on disk, or the entry of new data from the keyboard. In the latter case, there are the customary sub-menus for warping, hook-up (not tie-up because T is also the first letter of threading). Up to 24 shafts can be accommodated. Because the low-resolution graphics are used, the drawdown is limited to 40 warp ends and 40 weft picks. Each thread may be assigned any of the 16 lo-res colors.

The differences between WEAVER II and the earlier version are: (1) the program is written in Applesoft because most newer Apples have that as the ROM-resident language; (2) disk errors (disk full, I/O error, etc.) are trapped by the program so that a whole pattern cannot be lost when trying to save it; (3) single weft picks can be woven or erased; (4) drafts and data can be printed; and (5) errors in warping can be corrected in the EDIT mode without reentering the whole threading.

This program is extremely "user-friendly" once one becomes familiar with the various menus and their keywords. Entry of data is speedier than most of the programs we have reviewed, especially for patterns with repeats. Because the lo-res colors are used, there is no false-color problem except at the edges of the blocks for some color combinations. Depending on the user's printer and his/her skill in programming, it is possible to obtain several simulated shades of grey (varied dot density) in the hardcopies.

In addition to ease of use, one of WEAVER II's strongest points is that it is as hardware-independent as possible. In addition to the main program, the disk has the integer Basic version, RAM versions of both Basic interpreters, and several sample weaving drafts and their data. Most importantly, this program is *not* tied to one particular printer. The disk holds drivers (in Applesoft) for the IDS440 Paper Tiger, the Epson MX-80 the Centronics

737 and 739, and a routine for outputting the patterns as pseudo-graphics (X's or asterisks and blanks, for example) on line printers with no graphics capability. One only has to delete the default driver and EXEC the desired one in its place. We had no difficulty in changing the IDS440 driver to work with our 460.

The documentation within the program listing is excellent. A directory of all program modules is given at the end; this is invaluable if one needs to modify something or just wants to learn how the program works.

The only weaknesses of the program are: (1) the graphics are very slow as compared with most other programs (the others use machine-language graphics routines); (2) the menus are very terse (single keywords) and so are a little confusing to a new user. One *must* read the manual! (3) the manual is an update of the old one with the new features tacked on at the end, a number of typos, and some incorrect or obsolete information (it says there are only two printer drivers when there are five on the disk, and gives instructions for loading from cassette). We suggest a complete revision. (4) the editing routine allows one to change an incorrect shaft assignment in the threading, but does not provide for *inserting* one that has been omitted.

Despite these minor shortcomings, we heartily recommend WEAVER II to our readers.

Earl Barrett

## THE MANNINGS FALL WEAVING SEMINAR

October 26, 27, 28, 1982

**KLARA CHEREPOV**

All On A Straight Threading

**DONNA MULLER**

4 harness Double Weave: Cloth  
Construction And Practical Applications

**PHILIS ALVIC**

Variation On One Warp

**KARI LONNING**

Hen Baskets

For brochure and more complete details write:

**The Mannings**  
R. D. 2, East Berlin, PA 17316  
(717) 624-2223

## NEW COTTON-LINEN

55% COTTON/45% LINEN

A superb blend of cotton and linen in 28 vibrant colors plus natural. Suitable for both weaving and machine knitting. The put-up is 250 gram tubes (8.8 oz). Comes in 2 weights both in the full color range.

No. C12/2 Cotton-Linen, 1650 yds. per tube  
No. C 4/2 Cotton-Linen, 1100 yds. per tube

### COLORS:

No. 0	Natural	No. 15	Light Blue
No. 1	Bleached White	No. 16	Med. Blue
No. 2	Lemon Yellow	No. 17	Indigo Blue
No. 3	Golden Yellow	No. 18	Navy
No. 4	Yellow Orange	No. 19	Aqua
No. 5	Red Orange	No. 20	Yellow Green
No. 6	Warm Red	No. 21	Grass Green
No. 7	Deep Coral	No. 22	Forest Green
No. 8	Hot Pink	No. 23	Chartreuse
No. 9	Pink Violet	No. 24	Mustard
No. 10	Cranberry	No. 25	Beige
No. 11	Wine	No. 26	Lt. Brown
No. 12	Lilac	No. 27	Dk. Brown
No. 13	Royal Blue	No. 28	Black
No. 14	Slate Blue		

Give size of yarn and color number in ordering.

**\$9.95** per tube

Weaving Catalog \$1.00

Color samples available

**DEALER INQUIRIES INVITED**



**SCHOOL PRODUCTS CO., INC.**

1201 Broadway, New York, N.Y. 10001 (212) 679-3516

# PRODUCT NEWS

**100% NEW ENGLAND WOOL YARNS** are being produced in limited lots (up to 150 lbs.) by the GREEN MOUNTAIN SPINNERY, INC. The current edition contains various singles and plied yarns in natural white and grey. The yarns are suitable for weaving and knitting. Single-ply yields 530 yards per 4 oz. skein, two-ply yields 240 yards per 4 oz. skein and two-ply double twist yields 250 yards per 4 oz. skein. Retail price approximately \$4.20 per 4 oz. skein. Check your local supplier. Green Mountain Spinnery, Inc., P.O. Box 54, Putney, VT 05346.

**SILK** is available in a wide range of yarns from STRAW INTO GOLD. Yarns include Bombyx white silks in combed or noils yarns in yardages ranging from 500 to 1250 yards/lb. Tussah silks in combed and spun ranging from 5000 to 1750 yards/lb.; a merino/silk blend at 2000 yards/lb., soie sauvage at 1750 yards/lb. A recent addition is a silk boucle yarn which retail and wholesale orders at 3006 San Pablo Ave., Berkeley, CA 94702. For \$1.40 plus a SASE you will receive samples and prices of 13 silk yarns and the full color range of the silk boucle's.

**IMPORTANT TO DYERS WITH FIBER REACTIVE DYES:** A memo from STRAW INTO GOLD points out that the "new improved" Arm and Hammer washing soda caused bad dyeing results. It makes the dyes seem weaker. They recommend buying real washing soda or sal soda from a chemical supply house.

**HANDSPUN WOOL YARNS** from Guatemala are being introduced by BEKA under the name of LA SONRISA. It is a single, available in 20 colors and 5 natural shades and is put up in 100 g. skeins each yielding approximately 120 yards. Retail price approximately \$12.00 per skein. Check your local supplier. Beka Inc., 1648 Grand Ave., St. Paul, MN 55105.

**CONEWINDERS:** (No. C 340) are now being distributed by SCHOOL PRODUCTS CO., INC., to supply shops in the U.S. It looks similar to a ballwinder but winds the yarn onto a cone. School Products Co., Inc., 1201 Broadway, New York, NY 10001.

**ALPACA YARNS**, a thick 3-ply soft spun (size 3/2.5) is available from SILK CITY FIBRES. The fiber is worsted spun and comes in natural white, beige, brown and black. It is suitable for weaving and knitting yardage: 51 yds (46.6 m) per 1.75 oz. (50 g) ball. (Price, \$19.00 for 10 balls). For a test fabric, see p. 38 of this issue. Silk City Fibers, 155 Oxford St., Paterson, NJ 07522. Minimum orders: quantity discounts, charge for samples.

**NEW VEREL YARNS AND COTTON YARNS** are offered by WEAVERS' WAY. The new Verels have a composition of 70% Verel modacrylic and 30% viscose, the same as Alternative I and II but have different colors and textures. Linex has a linen look and comes in two sizes, 6/2 (2500 yards/lb.) and 3/2 (1250 yards/lb.). Softly Alternative is a soft single available in flax color and in white. The yield is 700 yards/lb. Linen and Softly Alternative are put up in 1/2 lb. spools at \$4.25 and in 1 lb. cones at \$8.25. Alternative Lace is a textured yarn (ratine) and is available in beige, flax and white, yield 900 yards/lb., price: \$9.25/lb. Weaver's Way offers perle cotton in natural and white in the following yarn counts: 3/2, 5/2, 10/2, all at \$8.75/lb. The sample box which was received also contained cotton/synthetic novelty yarns and 100% cotton textured yarns. All these are available in 8 oz. spools at \$4.40 and in 1 lb. cones at \$8.75.

As an experiment we used the 3/2 natural perle cotton and the 3/2 linen both in the warp and weft of some placemats set at 12 epi. The project turned out to be very successful.

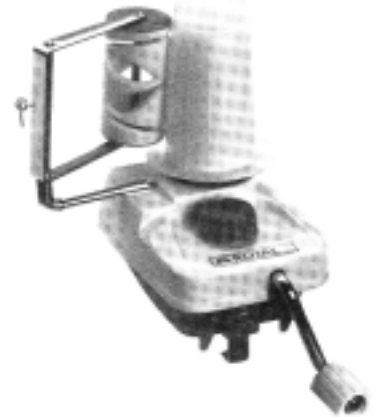

**SCOTTISH WOOLEN WEAVING YARNS** in a wide assortment of colors are available from J & D HIGHLAND IMPORTS. The Shetland 18 cut yields 3600 yards/lb. and is set at 18-24 epi for twills. Embo 9 cut is a Harris type, yields 1800 yards/lb. and is set at 16-18 epi for twills. Both yarns are single and are suitable for warp as well as weft. Price: Shetland, \$4.75 per 4 oz. ball or \$25.00 per 1 1/2 lb. cone. Embo, \$4.25 per 4 oz. ball or \$23.00 per 1 1/2 lb. cone. J & D Imports, P.O. Box 5497, Richmond, CA 94805. Retail mail orders only. \$2.00 charge for samples is refunded with first order.

**COLOR SELECTION** has been increased of BEKA SIMKIN "GREEN PASTURE" PURE PERENDALE WOOL which is imported from New Zealand and comes in two sizes. The 2-ply sport-weight yields 1400 yards/lb., the 3-ply worsted yields 930 yards/lb. Both put-ups are 6 oz. skeins and 24 oz. cones. Price approximately \$9.00 per skein. Check your local supplier. For a test fabric, see p. 29 in this issue. The project was very successful, the yarn easy to work with and the hand is good. 

## GRANDOR YARNS

### British imports

**COTTONS:** Textured (see picture) & 10/4 mercerised in colors.  
**WOOL:** Berbers, rovings & fine yarns. **NEW LOOPED BULKY YARNS.**  
**MOHAIR:** large looped yarn; also in colors  
**LINEN:** Knop (see picture), Cotton/linen. Warp yarns 4/6.8-6.10/6.8/3,12/3,16/3 & colored 8/5a.  
**SILK:** "SHANTUNG" 65% silk/35% wool, 10 colors. 100% silk tussah, 3 colors.  
**"SUNBEAM" YARNS:** "SOFIA", "CILICIA", "MOHAIR", "SUMATRA" all in delicate colors & textures.  
**McMORRAN YARN BALANCE:** still only \$14.95, discounts available

### Domestic supplies

**CHENILLE:** 3 & 5 cut, natural & colors.  
**"CLOTHING":** Barbara Hamaker's book \$7.95, discounts available.

**GRANDOR INDUSTRIES LTD.**  
Dept WJ, P.O. Box 5831, 4031 Knobhill Drive,  
Sherman Oaks, CA. 91403. (213) 784-5855.

We welcome you to our booths at Perspective '82 & Convergence '82  
Please note yarns are wholesale only to trade. Complete set of samples \$2.75

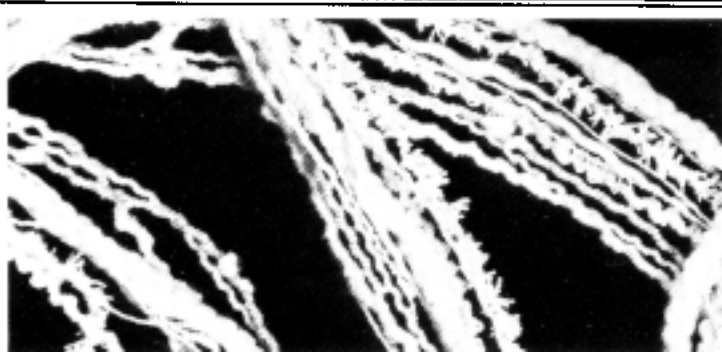

# COMING EVENTS

If your COMING EVENT item did not appear in this issue, we did not receive it in time. Deadline for Fall issue is July 1.

## ALABAMA

**Huntsville.** Oct. 22-24, 1982. Weaving workshop. Sponsored by The Handweavers and Fiber Arts Guild in co-operation with The University of Alabama in Huntsville. Conducted by Nell Znamierowski. Topic: Mixed Warps—A Designer's Approach to Fabric. For information write: Elvira Glover, 1308 Pratt Avenue NE, Huntsville, AL 35801

## CALIFORNIA

**Mendocino.** July 3-31, 1982. Show on "Tapestries". Artisans Guild Store, 45050 Main St., Mendocino, CA 95460.

**Mendocino.** Aug. 21-31, 1982. Second National Mushroom Dyed Fungi and Fibers Show. For details write: Clyde and Tigerlily Jones, The Artisans Guild Store, Box 1515, Mendocino, CA 95460.

**Ventura.** Nov. 12-14, 1982. Ventura County Handweavers Fall Show and Sale. Ventura County Historical Museum, 100 E. Main Street, Ventura, CA 93003.

## COLORADO

**Denver.** June 25-July 31, 1982. "Summervail 1982 Faculty Exhibit." Works from over 80 artists teaching Summervail workshops. Cohen Gallery, 665 So. Pearl, St., Denver, CO 80209.

**Durango.** July 14-19, 1983. Intermountain Weaver's Conference on the campus of The Lewis College. Workshops, Seminars, Demonstrations, Commercial Exhibits. For information send SASE to: Lois Self, 8550 E. Cuin Pl., Tucson, AZ 85710.

## INDIANA

**Indianapolis.** Oct. 29-30, 1982. Invitation to exhibit sponsored by Indiana Weavers' Guild. Exhibit and sale held at American Legion Building, 6379 N. College Ave., Indianapolis, IN. For information write: Holiday Handweavers, 514 Colbarn Ct., Noblesville, IN 46060.

## IOWA

**Ames.** July 8-11, 1982. Midwest Weaver's Conference hosted by the Iowa Federation of Handweavers and Spinners. Gerhard Knodel-major speaker. For details, write Jane Ann Stout, 286 Design, Iowa State University, Ames, IA 50011.

**Decorah.** July 23-25, 1982. First Annual Exhibition of Weaving in the Norwegian Tradition. In connection with Decorah, IA Nordic Fest. For information write: Lila Nelson, Curator of Textiles, Norwegian-American Museum, Decorah, IA 52101.

## MAINE

**Deer Isle.** Haystack Mountain School of Crafts, Deer Isle, ME 04627. (207) 348-6946. 3rd Session, July 18-30, Weaving: Barbara Wallace; 4th Session, Aug. 1-30, Fibers: Lenore Davis; 5th Session, Aug. 22-Sept. 10, Weaving: Albertje Koopman.

**Orono.** July 18-Sept. 11, 1982. Biennial juried show of spinning, weaving and related fiber crafts entitled "Challenge '82". Sponsored by The Maine Guild of Spinners and Weavers. Held at Carnegie Hall, University of Maine, Orono, ME.

## MINNESOTA

**Ely.** Sept. 10-11, 1982. 2nd Annual Conference of the Federation of Minnesota Weavers sponsored by Ely Weaving Guild. Held at Arrowhead Community College—the Vermillion Campus. For information write: Ely Weaving Guild, c/o Susan Saari-Karasti, 31 W. Chapman St., Ely, MN 55731.

## NEW JERSEY

**Laurenceville.** July 29-31, 1983. The Mid Atlantic Fibre Association is soliciting resumes and class outlines from teachers interested in mini-sessions of the 2nd Mid Atlantic Fibre Conference. For information, write Kava Schafer, Weisel Youth Hostel, R.D. 3, Quakertown, PA 18951.

## NEW MEXICO

**Los Alamos.** Exhibits at Fuller Lodge Art Center, Cultural Center, Center Ave., Los Alamos, NM

**JURIED CRAFT EXHIBIT** June 11-July 24. Partially funded by grant from New Mexico Arts Div. and the National Endowment for the Arts.

**NIGERIAN FIBRE ARTS** July 30-Aug. 20. Embroidery, tie-dye, and batik by Nike Olaniyi of Oshogbo, Nigeria. Workshop.

**ANTIQUÉ LACE & ART SALE** Sept. 24-Oct. 1. Antique clothing & lace, much of it convent made.

**LAS TEJEDORAS DE SANTA FE Y LOS ALAMOS** Oct. 8-Nov. 8. Exhibition of on & off-loom weavings.

**HOLIDAY ART** Dec. 3-Jan. 11, 1983. Juried exhibit open to artists & craftsmen from Northern New Mexico of work with Christmas, Hanukah, or seasonal theme. For information on any of above write: Karen Purucker, Director, Cultural Center, P.O. Box 790, Los Alamos, NM 87544.

**Los Alamos.** Sept. 24-Oct. 1, 1982. Sale of laces, embroideries, fabrics and clothing from the early 1900's. Most are imported from Spain, Cuba, China and France; much of the work no longer being done. One time only sale. Fuller Lodge Art Center. For information write: Karen Purucker, P.O. Box 790, Los Alamos, MN 87544.

## NEW YORK

**Ithaca.** Aug. 5-8, 1982. Fourth Annual Upstate Crafts Fair. Juried. Demonstrations. Workshops. Featuring Thomas S. Buechner III. Ithaca High School. For information write: Upstate Crafts, P.O. Box 173, Ithaca, NY 14850.

## TENNESSEE

**Gatlinburg.** June 7-Aug. 20, 1982. Summer Faculty/Staff Mixed Media Exhibitions at the Arrowmont Gallery.

**Gatlinburg.** Oct. 6-Nov. 20, 1982. "Spotlight '82: Southeast Crafts". Sponsored by Arrowmont School of Arts and Crafts and Southeast Region of the American Craft Council. Juried by Mel Someroski. For information write: Sandra Blain or Clare Versteegen, Arrowmont School, Box 567, Gatlinburg, TN 37738.

**Memphis.** Oct. 1-Oct. 30, 1982. Third Biennial "Path of the Weaver" exhibit. Southwestern University's Clough Hansen Gallery, Memphis, TN. Sponsored by Memphis Guild of Handloom Weavers. Juried by Gary Trentham. For information write: Betty Graves, 120 Grove Park South, Memphis, TN 38117, or Martha Whitaker, 905 Park Valley Rd., Memphis TN 38117.

## WASHINGTON

**Seattle.** June 11-July 25, 1982. Historic Costume and Textile Collection. Bellevue Art Museum. Courtyard, Bazaar, Temple: Traditions of Textile Expression in India. Co-sponsored by the South Asian Studies Program. An interpretive exhibition of resist dyed, ikat, printed and painted textiles of Rajasthan, Gujarat, Orissa, and Andhra Pradesh. Photo documentation of processes; photos; loom and tools; maps; texts. Textiles drawn primarily from the Elizabeth Bayley Willis Collection of Indian Textiles. Lecture, film, textile symposium. For information contact Katherine F. Hacker, Project Director, or Krista Turnbull, Curator, Historic Costume and Textile Collections, DL-10, University of Washington, Seattle, WA 98195.

**Seattle.** July 15-18, 1982. Convergence '82. Biennial meeting of the Handweavers Guild of America. Four day fiber extravaganza preceded and followed by workshops.

**Seattle.** August 1-28, 1982. Four week Crafts Tour to Visit South Pacific Region. For information send SASE to Michael Scott, 3632 Ashworth North, Seattle, WA 98103.

**Tacoma.** July, 1982. Handwoven "82" in Kirtledge Hall, University of Puget Sound. Juried by Peg McNair. Sponsored by Tacoma Weavers' Guild and Tacoma Fibercrafters. For information write: Aurabelle Walker, 3109 No. 29, Tacoma, WA 98407.

## WISCONSIN

**Menasha.** Sept. 18, 1982. Wisconsin Spin-In co-sponsored by the Fox Valley Spinning Guild and the Fox Valley Technical Inst. Theme—"Spin A Rainbow." Keynote speaker Marci Archer. Guild and commercial displays. For information contact: Karin W. Lager, president, Fox Valley Spinning Guild, 636 State Street, Menasha, WI 54952.

**Sheboygan.** July 17-18, 1982. Twelfth Annual Outdoor Arts Festival. Juried Exhibitions, workshops. For information write: Mary Jo Ballschmider, John Michael Kohler Arts Center, 608 New York Ave., P.O. Box 489, Sheboygan, WI 53081.



**Whitewater.** July 18-Aug. 6, 1982. 7th Annual Fiber and Textile Exhibit. Sponsored by Whitewater Spinners and Weavers Guild. Crossman Gallery on Whitewater Campus of the University of Wisconsin. For information write: Mary Hjelter-Squire, 358 Wilson Ave., Janesville, WI 53545.

WASHINGTON, D.C.

**The Textile Museum,** 2320 'S' Street, N.W. Exhibit May 1-Sept. 11, 1982. Holdings of Late Roman textiles, also known as Coptic textiles, shown and documented for the first time. "THE ROMAN HERITAGE: Textiles from Egypt and the Eastern Mediterranean, 300-600 A.D." For more information write: Mary Burgess, The Textile Museum, 2320 'S' Street, N.W., Washington, D.C. 20008.

Apr. 22-Sept., 1982. Coptic Textiles. The history of late Roman textile design as revealed by pieces preserved primarily in Egypt.

June-July, 1982. Ecuadorian Rugs by Olga Fisch. Rugs woven in the atelier of Olga Fisch, shown simultaneously in the Museum's exhibition and shop galleries.

July 10-Sept. 25, 1982. Oriental Rugs from the Hajji Baba Club collection. In celebration of the 50th anniversary of the oldest oriental rug society in America, the Hajji Baba Club selected 50 outstanding pieces from collections of past and present club members.

**Touchstone Gallery,** June 24-July 22, 1982. 15th Biennial Creative Crafts Council Exhibition. 2130 P St., N.W., Washington, D.C.

#### CANADA

**Cape Breton, Nova Scotia.** Oct. 2-3, 1982. The 1982 Weaver's Conference held at College of Cape Breton, Sydney, Cape Breton, Nova Scotia. Theme: Clothing from handwoven material. Guest: Christine Younie. For more information contact: Nova Scotia Designer Craftsmen, P.O. Box 3355, South, Halifax, Nova Scotia B3J 3J1.

**London, Ontario.** Oct. 15-17, 1982. 1982 Annual Conference of the Ontario Handweavers and Spinners. Hosted by London District Weavers. "My Country is Winter". Speaker: Micheline Beauchemin. Workshops, Room Shows. For information: Susan Haslett Scholfield, 17 Holland Ave., Chatham, Ontario N7M 5X8.

**Montreal, Quebec.** Opening June 10 through the summer. Jack Lenor Larsen—"Thirty Years of Creative Textiles." Retrospective show at the Musée des Arts Décoratifs, Montreal.

**Ste-Foy, Quebec.** Workshops offered at "La Maison Routhier" in weaving, tapestry, spinning and natural dyeing. Autumn session from August to December. Special for August: traditional Quebec weaving. For information write: Louise Landry, 3325 rue Rochambeau, Ste-Foy G1X 2T9, Quebec, Canada

**Vancouver, British Columbia.** June 30-Aug. 1, 1982. The Comfortable Arts by Dorothy Burnham will be exhibited at Vancouver Centennial Museum.

#### NEW ZEALAND

**Masterton.** January 20-31, 1984. World Congress on Coloured Sheep. Marketing, breeding, speakers, tours. For information, write Robert P. Williams, World Congress on Coloured Sheep and Their Products, R. D. 12, Masterton, New Zealand.



## SONG OF THE SKY LOOM

Oh our Mother the Earth, Oh our Father the Sky,

Your children are we, and with tired backs

We bring you the gift that you love.

Then weave for us a garment of brightness;

May the warp be the white light of morning.

May the weft be the red light of evening,

May the fringes be the falling rain,

May the border be the standing rainbow.

Thus weave for us a garment of brightness

That we may walk fittingly where the birds sing. . . .

*A Tewa song prayer, translated by Herbert Joseph Spinden. Used with permission.*

*Notecards with the Navajo weaver, as shown above, are available from the Colorado Fiber Center. See page C, center insert, this issue.*

# THE WEAVER'S MARKET-CLASSIFIED

## PUBLICATIONS

**handLOOMED LACES:** 15 techniques—illustrated—complete instructions. \$5.50 plus 50¢ postage—wholesale discounts available. Order direct from author GLADY WONNACOTT, formerly GLADYS ROGERS BROPHIL, 6415 Scenic Dr., Sault Ste. Marie, MI 49783.

**MONOGRAPH:** Norwegian Double Weave Pick Up Directions and Designs by Helen Brewer. \$4.00. \$1.00 postage. HANDWEAVER, 340 Coventry Road, Virginia Beach, VA 23462.

 **NEW revised edition**  
Send \$5.95 to: Indigo Press  
**DOROTHY MILLER**  
5950 Fern Flat Rd  
Aptos, CA 95003  
Order form for Free indigo seeds in each book

**PATTERN DEVICES FOR HANDWEAVERS—** 125 pages, illustrated: Practical information on mechanisms ranging from pick-up sticks to drawlooms, effective loom modifications, and instructions for damask, double weave, warp pattern, weft pattern. \$18.00 plus \$2.00 shipping. (MD residents add .90 tax.) DORAMAY KEASBEY, 5031 Alta Vista Rd., Bethesda, MD 20814.

**THE DYERS' BOOK** by Kampert and Henrikson. Wool, silk, cotton, linen, viscose-rayon yarns dyed in 83 Cushing colors (420 samples). Text includes: dyeing procedures and tips, fiber preparation and care. 8 1/2 x 11" card stock. 26 pages. 3-ring binder. \$50.00 (+ \$2.50 shipping and handling). Send check or inquiry to: MOUNTAIN FIBER STUDIO, 3060 Ash Avenue, Box WJ, Boulder, CO 80303.

**TRS 80 PROGRAM** for automated draw-downs. Up to 8H / 10 Tr / 116 threads. Screen display shows all features of standard draw-downs. Complete freedom of choice for tie-up, treadling sequences, thread-by-thread and/or profile drafts. B/W color sequences for warp and/or weft. For Model I, Level II, 16K and/or Model III, 16K. On cassette with complete instructions \$35.00 W. SALSBURY ASSOCIATES, INC., 608 Madam Moore's Lane, New Bern, NC 28560.

 **EXCELLENCE** in Jack-Type floor Looms in 4 and 8 harness. 24", 32", 40" and 45" widths.  
Write for new brochure. Dealer Inquiries Invited.  
**HERALD LOOMS**  
118W LEE STREET, LODI, OHIO 44254

Rate is 50¢ per word—\$10.00 minimum. Deadline for Fall issue is July 1.

## STUDY OPPORTUNITIES

**WEAVING WORKSHOP**, sponsored by The Handweavers and Fiber Arts Guild in cooperation with The University of Alabama in Huntsville, will be conducted by Nell Znamierowski on October 22-24, 1982. Topic: Mixed Warps—A Designer's Approach to Fabric. For information contact ELVIRA GLOVER, 1308 Pratt Avenue NE, Huntsville, AL 35801, or call (205) 534-4642.

**TEXTILES IN SOUTHEAST ASIA TOUR** October 20—November 10, 1982. Bangkok, Chiang Mai, Singapore, Java, Bali, Sulawesi, Hong Kong. Optional 10-day extension to China. Information: Frances Taylor and Dorothy Perednia, 3925 Stockton Blvd., Sacramento, CA 95820.

## MISCELLANEOUS

**FLOOR & TABLE LOOMS** designed by Rollo Purrington, made by the NORRISES, 52W Willowbrook Road, Storrs, CT 06268. SASE for brochure.

**TIRED TEASING FLEECE?** The Wool Picker from Paula Simmons *Handweaving Guide for Selling* available for purchase. You can tease one pound unmatted fleece in five minutes. Information send SASE. WOOL PICKER, Rt. 1, Box 28F, Moxee, WA 98936 (509) 453-0183.

**SILK AND WOOL . . .** hand dyed with natural dyes. Large color selection in weaving, knitting, and stitchery yarns. Samples: Silk \$6.00. Wool \$4.00. DYEWORKS WJ4, 312 So. 3rd St., Minneapolis, MN 55415. (612) 333-7246.

### BOOKS FOR THE HOME CRAFTSMAN

**EARTH BASKETRY:** Known as Complete Basket Manual. Hard cover . . . \$7.95  
**THE JOY OF HANDWEAVING:** Basic instruction for beginners, with guidance for teachers. 40 step by step lessons. Hard cover . . . \$7.95  
**RUGWEAVING FOR EVERYONE:** Pile, Tapestry, 4 to 8-harness. Tufted and Flat techniques. Paperback . . . \$4.50  
**BOBBIN LACE STEP BY STEP:** Directions for making your own pillow, beginners & practical patterns. \$7.50

OSMA GALLINGER TOD  
WEAVING STUDIO  
319 Mendoza Ave  
Coral Gables, FL 33134

## YARNS, FIBERS AND FLEECE

**MOHAIR-WOOL LOOP—NEW STOCK—17** colors. Also camel hair & alpaca. Samples—send LSASE. CUSTOM HANDWEAVING, Box 477, Redondo Beach, CA 90277-0477.

**SILKS—TRAM, MANY NEW** colors. Tussah-7 colors, Doupiou-8 colors. \$28/lb. Samples \$3.00. CUSTOM HANDWEAVING, Box 477, Redondo Beach, CA 90277-0477.

**NEW ZEALAND WOOL YARN—**Hundreds of colors in weaver weights. \$3/lb. (Minimum 10 lbs.) or \$2.75/lb. over 40 lbs. \$3.00 for yarn color card or send your color for our best match. Add 20¢/lb. shipping/handling. MICHAELIAN AND KOHLBERG, 295 Fifth Avenue, New York, NY 10016.

**COTTONS, SILKS, WOOLS—**beautifully textured yarns, bulky and fine, for all your weaving needs. New silk noil and wool blend, ideal for light weight fall wearables. Exotic tops for spinning, including our new 50% silk/50% wool tops. Complete line of spinning and weaving equipment, books, and supplies. Samples: Yarns \$1.50; Spinning Fibers \$1.50. Catalog only, 75¢. LINDA SNOW—FIBERS, Fiber Headquarters of the Southeast, 3209 Doctors Lake Dr., Orange Park, FL 32073.

**SPECTRALAN,** New Fiber Reactive Wool Dye. Extra-high wash/light fastness. Brilliant colors. SASE for information to: SPECTRUM DYESTUFFS, P.O. Box 2904-WJ, Oakland, CA 94618.

**MILL ENDS,** wools, cottons, synthetics and blends: To receive mailings of our mill ends as we get them, send \$3.00—at least four mailings per year. LINDA SNOW—FIBERS, Fiber Headquarters of the Southeast, 3209 Doctors Lake Drive, Orange Park, FL 32073

**BASKETRY MATERIALS—**Complete line of basketry reed, ash and white oak splints, cane and caning supplies, books. To add texture and interest to your baskets, grass or palm rope, sisal or jute fibers, and a variety of bulky yarns including MARCISPUN, super bulky handspun wool in beautiful solid colors, and YARNS BY JEANNE, variegated bulky yarns, each color blended and handspun of several shades wools. Samples: Basketry Fibers, 75¢; Bulky Yarns, 75¢; MARCISPUN Color Card, 75¢. LINDA SNOW—FIBERS, Fiber Headquarters of the Southeast, 3209 Doctors Lake Dr., Orange Park, FL 32073

**SHEEPSKIN PIECES—**Cleaned, random sizes. Make rugs, vests, seatcovers. Instructions with order. 1 lb. -\$4.00; 5 lbs. -\$16.00; 10 lbs. -\$28.00 plus shipping. CUSTOM HANDWEAVING, Box 477, Redondo Beach, CA 90277-0477.



### NEEDLE BAGS

A special place for your needles  
blue satin or calico print.

\$6.00 + \$1.00 shipping

Send to: **GEMMA PRODUCTIONS**  
P.O. BOX 1254, Bensalem, PA 19020



## The Weaver's Loft

*for your weaving and spinning needs.*

• Schacht (at discount) • Norwood • Harrisville •

*Unique fashion threads for knitting and crochet*

Catalog \$1.00 + postage, refundable with first order.

Open Monday-Thursday, 11-5; Friday 11-7; Saturday 9-5

(815) 786-2233

215 West Center, Sandwich, IL, 60548

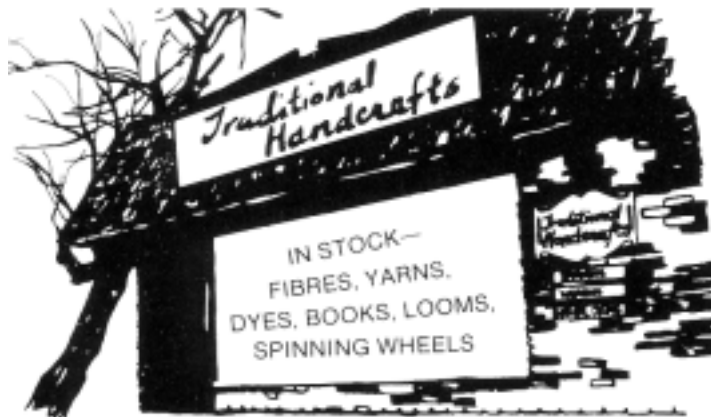

154 Mary Alexander Court, Northville, MI 48167 (313) 349-7509



**TWILLS and  
TWILL DERIVATIVES**  
Lucille Landis (2nd printing)

*No need to depend on recipes for your twills! Use a logical approach to understand their construction, then design YOUR OWN four to eight harness fancy, braided, interlocking, corkscrew, decorated, and waving twills, or crepes, waffles, and shadow weaves.*

*150 B&W photos, nearly 300 patterns, 120 pages, soft cover, \$10.50. Add 7 1/2% Sales Tax in Conn. Postage \$1.50 per copy, \$.35 add. copy. Dealer inquiries invited.*

Book Barn, Box 256, Avon, CT 06001

## ADVERTISERS INDEX

Ayottes' Designery	6
Bradshaw Manufacturing Co.	67
Classified Ads	72
Colorado Fiber Center, Inc.	5
Colorado Fiber Center, Inc.	31
Dos Tejedoras	67
Dyeworks	72
Doophlicque Loom	25
Kerry Evans	<i>ifc</i>
Gemma Productions	<i>ibc</i>
Glimakra Looms 'n Yarns, Inc.	2
Golden Fleece	8
Golden Heddle	4
Grandor Industries Ltd.	69
Harrisville Designs	8
Henry's Attic	<i>ifc</i>
Herald Looms	72
Ruth N. Holroyd	62
Indigo Press	72
J & D Highland Imports	6
Lucille Landis	<i>ibc</i>
Macomber Looms	7
The Mannings	1
The Mannings	68
Oriental Rug Co.	62
Pendleton Shop	1
Katherine Ramus	67
Restoration Arts	1
Scantex, Inc.	<i>back cover</i>
Schacht Spindle Co., Inc.	9
School Products Co., Inc.	68
Serendipity Shop	4
Siever's Looms	'8
Silk City Fibers	4
Osma Tod Weaving Studio	72
Traditional Handcrafts	<i>ibc</i>
Two Cape Cod Weavers	1
The Unicorn	1
Van Nostrand Reinhold Co., Inc.	65
The Walking Wheel	<i>ifc</i>
The Weaver's Loft	<i>ibc</i>
Weavers' Loft	67
Weaver's Way	8
John Wilde & Brother, Inc.	<i>ifc</i>
The Wool Gallery	6

# Discover Two of the Scandinavians' Favorite Weaving Secrets . . .

## Poppana Bands and Rana Wools

Imported from Finland for your own authentic Scandinavian textiles. Easily woven even on simple looms.

**Poppana Bands** make rag weaving fast and easy. Available in 30 colors. 100 percent new cotton material on easy-to-use rolls. Instructions for weaving traditional Poppana textiles also available. Reasonably priced.

Brighten and warm your surroundings with traditional **Ranas**. 100 percent virgin wool available by the skein or in kits in 72 beautiful colors. Comparable in price to domestic yarns.

Use the order form on this page, or write:



P.O. Box 552-J  
Larkspur, CA 94939  
(415) 924-9123

### ORDER FORM

Name \_\_\_\_\_  
Address \_\_\_\_\_  
City, State, Zip \_\_\_\_\_

CHECK the boxes in brackets for items requested:

<input type="checkbox"/>	Shipping Information	.....	no charge
<input type="checkbox"/>	Rana Wool Sample Card	.....	\$1
<input type="checkbox"/>	Poppana Sample Card	.....	\$1
<input type="checkbox"/>	Instructions for Poppana Bag	.....	\$1
<input type="checkbox"/>	Color Poster — 15 Ranas	.....	\$1
<input type="checkbox"/>	Poppana Catalog	.....	\$6
Total Enclosed (U.S. funds only)		.....	\$

Enclose check payable to Scantex, and mail to Scantex, P.O. Box 552-J, Larkspur, CA 94939.

# The Weaver's Journal

INDEX AND ERRATA VOLUME VI JULY 1981-APRIL 1982

- Andean Tubular Trim**, VI/3, pp. 54-58.
- Accessories**  
*Bags*, VI/2, pp. 24-27; VI/3, p. 40.  
*Boots*, VI/4, pp. 44-45.  
*Hats*, VI/3, pp. 39-40.  
*Tool Kit*, VI/4, p. 46.
- Baskets**  
*Double Handled Melon Basket*, VI/4, pp. 42-43.
- Bags**  
*Double Handled Melon Basket*, VI/4, pp. 42-43.  
*Furoshiki*, VI/3, p. 40.  
*Salt Bag*, VI/3, p. 40.  
*Tagari* (Greek saddlebag), VI/2, pp. 24-27.
- Blouses**  
*Textured Cotton*, VI/3, pp. 20-26.
- Book Reviews**  
*Ancient Danish Textiles From Bog Burials* by Margrethe Hald, VI/4, p. 58.  
*The Art of the Felt Maker* by M. E. Burkett, VI/3, p. 59.  
*Atlas de 4000 Armures de Tissage et Elements d'Ornementation Pour Articles de Maille* by Louis Serrure, VI/4, p. 59.  
*Back to Basics: How to Learn and Enjoy Traditional American Skills*, VI/2, p. 40.  
*Bolivian Indian Textiles*, VI/3, p. 60.  
*Color and Weave* by Margaret and Thomas Windeknecht, VI/2, p. 39.  
*Considerations for the Care of Textiles and Costumes* by Harold F. Mailand, VI/2, p. 40.  
*Fibre Facts* by Bette Hochberg, VI/4, p. 60.  
*Fun With Felt* by Annette Feldman, VI/2, p. 40.  
*The Guide to Successful Tapestry Weaving* by Nancy Harvey, VI/2, p. 39.  
*Hali*. The International Journal of Oriental Carpets and Textiles, VI/1, p. 54.  
*Hammock Making* by Penelope Drooker, VI/4, p. 60.  
*Handspinning: Art and Technique* by Allen Fannin, VI/4, p. 59.  
*Latin American Brocades* by Suzanne Baizerman, VI/4, p. 57.  
*Making Rugs For Pleasure and Profit*, VI/4, p. 60.  
*Making Simple Clothes* by Ida Hamre, VI/4, p. 58.  
*Multiple Tabby Weaves*. Based on Dr. W. G. Bateman's Manuscript, VI/2, p. 39.  
*Nigerian Handcrafted Textiles* by Joanne Bulolz Eicher, VI/4, p. 59.  
*Older Ways—Traditional Nova Scotian Craftsmen* by Peter Barss, VI/2, p. 40.  
*Oriental Rugs Care and Repair* by Majid Amini, VI/4, p. 57.
- Oriental Rug Repair* by Peter Stone, VI/4, p. 57.  
*Pattern Making by The Flat-Pattern Method* by Norma Hollen, VI/4, p. 60.  
*Pattern Devices For Handweavers* by Doramay Keasbey, VI/4, p. 57.  
*Processing and Finishing Handwoven Textiles*. The Weavers Guild of Boston, VI/1, p. 54.  
*Rug Hooking & Rug Tapestries* by Ann Wiseman, VI/1, p. 54.  
*Rug Weaving, Technique and Design* by Brian Knight, VI/3, p. 60.  
*Salish Weaving* by Paula Gustafson, VI/3, p. 59.  
*Stora Vavboken* by Laila Lundell, VI/2, p. 53.  
*The Textile Colorist* by Faber Birren, VI/2, p. 53.  
*Textiles, Costumes and Doll Collections* Edited by Pieter Bach, VI/4, p. 57.  
*Textile History*, VI/3, p. 60.  
*Textiles of Baluchistan* by M. G. Konicny, VI/1, p. 54.  
*Treaded Togs, a Pattern Book of Loom-fashion Clothing* by Kerry Evans, VI/2, p. 39.  
*Warp Painting* by Dominic Nash, VI/3, p. 59.  
*Warp/Weft/Set* by June Beveridge, VI/4, p. 59.  
*The Weaving Book* by Helene Bress, VI/3, p. 60.  
*Weaving on a Frame Loom* by Mary Lonning Skoy, VI/4, p. 58.  
*Weave it! 28 Projects for Your Home* by Marilyn Meltzer, VI/3, p. 61.  
*Weaves of the Incas* by Ulla Nass, VI/4, p. 53.  
*The Woolcraft Book* by Constance Jackson & Judith Plowman, VI/4, p. 59.
- Boots*, VI/4, pp. 44-45.  
*Cape*, VI/3, pp. 26-27.  
*Catalogne*, VI/4, pp. 10-11.  
*Ceinture Flechee, 4-shaft Adaptation*, VI/4, p. 14.
- Chenille**  
*Uncut*, VI/4, p. 4.  
*Cut*, VI/4, pp. 26-27.
- Christmas**  
*Nativity Scene*, VI/2, pp. 8-9; VI/2, pp. 59-60.
- Computers**, VI/3, pp. 42-43.  
*Computer Loom*, VI/1, p. 34, VI/3, p. 62.  
*Drawdowner*, VI/2, p. 62.  
*Video Loom II*, VI/4, p. 62.
- Costumes**  
*Nativity Scene*, VI/1, pp. 8-9.  
*18th Century*, VI/3, pp. 38-39.
- Counter-march**  
*Tie-up for Counter-march Loom*, VI/3, p. 47.
- Coverlets**, VI/2, pp. 54-56.
- Double Weave**, VI/3, pp. 12-13.  
*Long-eyed Heddles*, VI/2, pp. 35-38.  
*Double-woven Jacket*, VI/3, p. 25.  
*Double-woven Shirt*, VI/3, p. 25.  
*Double-woven Boots*, VI/4, pp. 44-45.
- Drafting**  
*Basics*, VI/2, pp. 50-53.
- Dye**  
*Creutex*, VI/3, p. 62.  
*Cushing Dyes*, VI/3, p. 62.  
*Dyeworks*, VI/3, p. 63.  
*Spectralan* (Fiber Reactive), VI/4, p. 61.  
*Spice Dyeing*, VI/4, p. 47.
- Ecclesiastical Weaving**, VI/1, pp. 35-36; pp. 40-41.  
*Eucharistic Vestments*, VI/1, pp. 37-39.  
*Talis*, VI/1, pp. 42-43.  
*Stoles and Chasubles*, VI/1, pp. 46-48. Edging (See Trim).
- Equipment**  
*Loom Sleyer*, VI/4, p. 62.
- Fabric Analysis**  
*Basics*, VI/2, pp. 50-53.
- Fashion Designer**, VI/3, pp. 10-11; VI/3, p. 29.  
*Fashion Trends*, VI/3, pp. 6-7.
- Felting**, VI/1, pp. 31-32.
- Garments**, VI/4, pp. 18-20.  
*Blouses, Dress, Robe*, VI/3, pp. 20-26.  
*Cape*, VI/3, pp. 26-27.  
*Double Woven Jacket*, VI/3, pp. 16-17.  
*Gala Raincoat*, VI/3, pp. 12-13.  
*Jacket With Handspun Yarn*, VI/2, p. 20; VI/3, p. 35.  
*Jacket With Overshot*, VI/3, pp. 8-9.  
*Rags*, VI/3, pp. 30-32.  
*Shirt (African)*, VI/3, pp. 33-34.  
*Skirt*, VI/4, pp. 18-20.  
*Textured Cotton Tops, Shrug, Blouses, Dress, Robe*, VI/3, pp. 20-26.  
*Textured Jacket*, VI/3, p. 15.  
*Tunic*, VI/3, p. 18.  
*Vest*, VI/3, p. 36; (Leno) VI/4, pp. 16-17.
- Guatemalan Brocade**, VI/4, pp. 39-41.
- Hats**, VI/3, pp. 39-40.
- Hemstitching**, VI/4, p. 11.
- Ikata**  
*Kasuri-like Effect Spinning*, VI/2, pp. 18-19.
- Inlay**  
*Loom Controlled*, VI/3, pp. 26-27.
- Jacket** (See also Vests)  
*Double Woven*, VI/3, pp. 15-16.  
*Handwoven & Leather*, VI/3, p. 15.  
*Jacket With Overshot*, VI/3, pp. 8-9.  
*Texture Handspun Yarn*, VI/2, p. 20.  
*Woven With Rags*, VI/3, pp. 31-32.
- Lace** (See Leno)  
*Bead-Leno*, VI/1, pp. 50-53.  
*Pick-up Leno*, VI/2, pp. 48-49.

## ERRATA—Volume VI

### VOLUME VI/4

ALL WHITE OVERSHOT RUGS BY CONNIE KINDALL. Spring 1982, p. 23. The repeats in the treadling have been omitted from the draft. Please correct the treadling as shown here.

### THREADING, TIE-UP AND TREADLING:

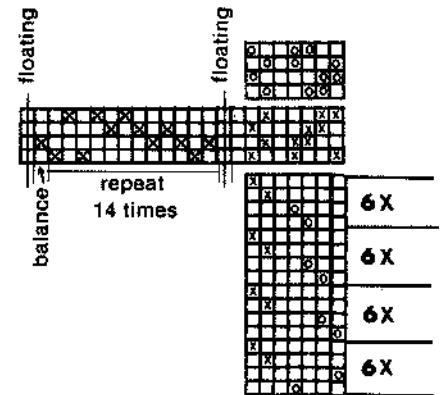

### Volume VI/4

DOUBLE HANDLED MELON BASKET BY MARIE GRASER. Spring 1982, p. 42, Figure 2—drill hole and insert 1 nail. p. 43, 2nd pp., line 4: Soak in hot water for 25 minutes. With a . . .

### Volume VI/3

A SHORT AND SWEET DRAW-DOWN PROGRAM FOR COMPUTERS by Earl Barrett. p. 42, Winter 1981-82.

Line 90 of Listing 1 should end in a semicolon, not a comma.

A reader has suggested that the =1 in lines 60 and 70 of Listing 1 should be replaced by =0 (zero). The ones did appear in the listing as we received it. If you have had trouble running the ZX80 program, try this change.

- Shirt  
*African Strip-cloth Shirt Without Strips*, VI/3, pp. 33-34.
- Skirt, VI/4, pp. 18-20.
- Spinning-Weaving With Handspun Yarn, VI/2, p. 20; VI/2, p. 21-23; VI/2, p. 41; VI/2, pp. 48-49; VI/2, pp. 57-58.
- Greece*, VI/2, pp. 24-27.
- Kasuri-like Effect*, VI/2, pp. 18-19.
- Spinning Wheels  
*Camelot*, VI/3, p. 63.  
*Restoration Arts Spinning Wheel*, VI/2, p. 23.
- Stoles. (See Shawls)
- Summer & Winter, VI/4, pp. 48-52.
- Tablecloth  
*Mock-Ieno*, VI/1, p. 12.  
*Overshot and Pick-up Ieno*, VI/1, pp. 10-11.  
*Unbalanced Broken Twill*, VI/1, p. 9.
- Tapestries  
*Handspun Yarns*, VI/2, p. 41.  
*San Francisco Workshop*, VI/2, pp. 44-47; VI/3, pp. 50-53.  
*Window Coverings*, VI/1, pp. 15-17.
- Textile Craftspeople—Profiles and Interviews  
*Fannin, Allen*, VI/2, pp. 28-31.  
*Hamaker, Barbara*, VI/4, pp. 37-38.  
*Knollenberg, Barbara*, VI/3, pp. 10-11.  
*Schott, Lorelei*, VI/1, pp. 13-14.
- Tool Kit, VI/4, p. 46.
- Trim  
*Andean Tubular Trim*, VI/3, pp. 54-58.  
*Tubular Knitted Edging*, VI/3, p. 5.
- Tunic, VI/3, p. 18; VI/3, pp. 20-26.
- Twills, VI/3, pp. 46-47.
- Two- or More-tie Block Weaves, VI/2, VI/3, pp. 41-42;  
*Loom Controlled Inlay*, VI/3, pp. 26-27.  
*Two-tie Six-end Block Draft*, VI/4, pp. 30-33.
- Upholstery  
*Woven With Handspun Yarn*, VI/2, p. 21-23.
- Vests (See also Jackets), VI/3, p. 36.  
*Ieno*, VI/4, pp.  
*Textured Cotton*, VI/3, pp. 20-26.  
*Woven With Rags*, VI/3, p. 30.
- Warp Face Weaves (See also Rep Weaves)  
*Designs Related to Cardweaving*, VI/4, p. 36  
*Inkleband (Tool Kit)*, VI/4, p. 46.
- Weaves (See also under name of weave)  
*Honeycomb*, VI/2, p. 21-23; VI/3, p. 30.  
*M's & O's*, VI/1, pp. 27-30.  
*Surface Texture*, VI/3, pp. 20-26.  
*Two or More-tie Block Weaves*, VI/2, pp. 42-43, VI/3, pp. 41-42; VI/4, pp. 30-33; VI/4, pp. 48-52.  
*Waffle Weave*, VI/1, pp. 20-21.
- Window Coverings  
*Insulating Shades*, VI/1, pp. 18-19; VI/1, pp. 24-25.  
*Insulating Shutters*, VI/1, pp. 20-21.  
*Roman Shades and Draw Drapes*, VI/1, pp. 20-23.  
*Tapestry*, VI/1, pp. 15-17.
- Yarn Count Systems, VI/3, p. 28.
- Ieno  
*Doup-Ieno*, VI/1, pp. 24-25.  
*Mock-Ieno*, VI/1, p. 12; VI/1, p. 12; VI/1, pp. 22-23.  
*Pick-up*, VI/1, pp. 10-11; VI/2, pp. 48-49.  
*Bead-Ieno*, VI/1, pp. 50-53.  
*Chenille Ieno*, VI/4, pp. 26-27.
- Long-eyed Heddle Techniques  
*Double Weave*, VI/2, pp. 35-38.  
*Satin*, VI/1, pp. 25-26.
- Looms  
*Beka*, VI/3, p. 63.  
*Circular Loom*, VI/2, p. 41.  
*Counter-march*, VI/3, p. 47.  
*Herald Loom*, VI/3, p. 63.  
*Macomber*, VI/1, p. 33.  
*Norwood Loom*, VI/2, p. 61.  
*Ram Loom*, VI/2, p. 61.
- Loom Embroidery  
*Guatemalan Brocade*, VI/4, pp. 39-41.
- Loom-shaped Weaving, VI/3, pp. 33-34.
- Magazine Holder, VI/4, p. 21.
- Overshot  
*Coverlets*, VI/2, pp. 54-56.  
*Jacket*, VI/3, pp. 8-9.  
*Rug*, VI/4, p. 23.  
*Tablecloth*, VI/1, pp. 10-11.
- Paper  
*Handmade*, VI/2, pp. 12-13.  
*Weaving, Drawing, Painting*, VI/1, pp. 13-14.
- Peruvian Slings, VI/4, pp. 53-56.
- Pile  
*Corded Pile*, VI/4, p. 15.
- Placemats, VI/4, pp. 10-11.
- Planche (Travail A La), VI/4, p. 13.
- Point Boutonne, VI/4, pp. 12-13.
- Production Weaving/Design, VI/3, p. 29.
- Quebec  
*Weaving in Quebec*, VI/4, pp. 8-20.
- Raanu, VI/3, p. 18.
- Rags, (See Recycled Yarns)
- Recycled Yarns—Rags  
*Gala Raincoat*, VI/3, pp. 12-13.  
*Garments Woven With Rags*, VI/3, pp. 30-32.  
*Rag Rugs*, VI/4, pp. 10-11; VI/4, pp. 24-25; VI/4, p. 28.
- Rep Rugs, VI/4, pp. 15-16; VI/4, p. 21.
- Robe (Sauna), VI/3, p. 24.
- Rugweaving  
*Chenille*, VI/4, pp. 26-27.  
*Overshot*, VI/4, p. 23.  
*Pile Rug*, VI/4, p. 15.  
*Rag Rugs*, VI/4, pp. 10-11; VI/4, pp. 24-25; VI/4, p. 28.  
*Rep Rug*, VI/4, pp. 15-16.  
*Rug Techniques*, VI/4, pp. 34-35.  
*Selvages*, VI/2, pp. 10-11.  
*Two-tie Six-end Block Rug Weave*, VI/4, pp. 30-33.  
*Yarns*, VI/3, pp. 44-45.
- Saddle Blanket, VI/4, p. 29.
- Satin, VI/1, pp. 25-26.
- Shades (See Window Coverings)
- Shaft-Switching  
*How it Began*, VI/2, pp. 14-15.  
*3-end Draft*, VI/1, pp. 7-8; VI/2, pp. 16-17.
- Shawls, VI/2, pp. 57-58.  
*Shrug*, VI/3, pp. 20-26.  
*Stole With Hood*, VI/4, p. 20.  
*Triangular*, VI/2, pp. 48-49.

## JEWELRY

Wear a pewter handmade pin or pendant to display your craft as a spinner or weaver. Choose pins in the well known shapes of boat or stick shuttles if you are a weaver and rams or ewes if you are a spinner. Or put on a gleaming pendant depicting a drop shuttle, llama, ram, sheep or spinning wheel.

All this jewelry, which is shown full size, is especially handmade for the Colorado Fiber Center by Jeanne Nash and sells for affordable prices, too!

Supplies are limited, so hurry! Order yours today!

## NOTE CARDS

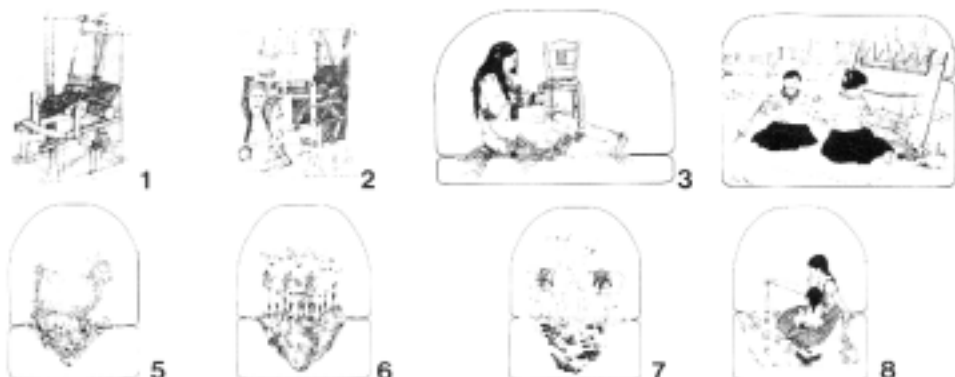

Choose notecards with the following designs:

1. Japanese ikat weaver. This pen and ink drawing with colored wash is the work of Karmen Ellenberger, a well-known Boulder artist.
2. Japanese spinner. This charming pen and ink drawing with colored wash is the work of Karmen Ellenberger. In both of these notecards, Ellenberger has captured an Oriental quality that is charming.

3-8. Fiber related cards by Kay Read. These black and white drawings enhanced with color are delightfully appealing for anyone to use, but particularly weavers and spinners.

All cards come with matching envelopes.

## MISCELLANEOUS

Peter Collingwood's working plans for a shaft-switch platform.

Pads of 20 Weaver's Record sheets on heavy paper, 4 shafts or 8 shafts.

## NEW

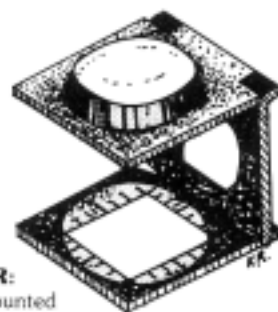

**LINEN TESTER:** double lenses mounted in black enameled brass frame, folds flat. 1" lenses, 5x magnification. \$16.50



**LOOM SLEYER:** double hooked reed hook made of brass. \$5.00



**METAL DOUP HEDDLES.** \$1.25 each plus shipping.

## ORDER FORM

### JEWELRY

___ Drop spindle pin . . . 1	10.00
___ Spinning wheel pendant . . . 2	10.00
___ Llama pendant . . . 3	10.00
___ Sheep pendant . . . 4	10.00
___ Ram pendant . . . 5	10.00
___ Stick shuttle pin . . . 6	6.00
___ Boat shuttle pin . . . 7	6.00
___ Ewe pin . . . 8	8.50
___ Sheep pin . . . 9	8.50
___ Ram pin . . . 10	8.50

### CARDS

___ Notecards, folder with 10 cards, item no. ___	3.00
___ Economy pack of 50 notecards, item no. ___	\$13.00

### MISCELLANEOUS

Peter Collingwood's shaft-switch plans	\$5.00
Weaving Record sheets (pad of 20)	
___ 4 shafts	2.00
___ 8 shafts	2.00
Loom sleyer	5.00
Linen tester	16.50
Metal doup heddles	

VISA # \_\_\_\_\_

MASTERCARD # \_\_\_\_\_

Expiration date \_\_\_\_\_

Signature \_\_\_\_\_

ADD \$2.00 handling charges for orders under \$30.00 No shipping charges except on doup heddles.

Colo. residents add 3 1/2% tax.

Send your order and check to: The Colorado Fiber Center Inc. Mail Service PO Box 2099, Boulder, CO 80306

Name \_\_\_\_\_ first \_\_\_\_\_ last \_\_\_\_\_

no. \_\_\_\_\_ street \_\_\_\_\_

city \_\_\_\_\_ country or state \_\_\_\_\_ zip code \_\_\_\_\_

BACK ISSUES AVAILABLE  
of  
THE WEAVER'S JOURNAL

Vol. III, No. 1, Issue 9, July, 1978  
 Vol. III, No. 2, Issue 10, October, 1978  
 Vol. III, No. 3, Issue 11, January, 1979  
 Vol. III, No. 4, Issue 12, April, 1979 \$2.75 each

Vol. IV, No. 1, Issue 13, July 1979  
 Vol. IV, No. 2, Issue 14, October 1979  
 Vol. IV, No. 3, Issue 15, January, 1980

Vol. IV, No. 4, Issue 16, April, 1980  
 Vol. V, No. 1, Issue 17, July, 1980  
 Vol. V, No. 2, Issue 18, Fall, 1980 \$3.50 each

Vol. VI, No. 1, Issue 21, Summer 1981  
 Vol. VI, No. 2, Issue 22, Fall 1981

Vol. VI, No. 3, Issue 23, Winter 1981-'82 \$4.50 each  
 Vol. VI, No. 4, Issue 24, Spring 1982

Photocopies of earlier Issues:

Vol. I, No. 3, Issue 3, January, 1977  
 Vol. I, No. 4, Issue 4, April, 1977 \$2.50 each  
 Vol. II, No. 1, Issue 5, July, 1977

FOR OFFICE USE ONLY

(303) 449-1170



P.O. Box 2049  
Boulder, Co., 80306 U.S.A.

**SUBSCRIPTION FORM**

*The Weaver's Journal*, A Quarterly Publication for Textile Crafts people.

Please accept my order for the items checked below:

	U.S.A.	Outside U.S.A.
Subscription, 1 Year (4 issues)	\$15.00	\$18.00
Subscription, 2 Years (8 issues)	\$29.00	\$34.00

**TOTAL PAYMENT ENCLOSED**

\$ \_\_\_\_\_ \$ \_\_\_\_\_

Please make checks or money orders, in U.S. funds, payable to: *The Weaver's Journal*, P.O. Box 2049, Boulder, Colorado 80306. (U.S.A.)

If this is a GIFT  subscription, check the box and give your name and address here, otherwise skip the next three lines.

Donor: NAME \_\_\_\_\_  
(Last) (First) (Middle)

ADDRESS \_\_\_\_\_  
(City) (State or Country) (Zip)

Subscriber: NAME: \_\_\_\_\_  
(Last) (First) (Middle)

ADDRESS: \_\_\_\_\_  
(City) (State or Country) (Zip)

Subscription is to begin with issue:  January  April  July  October

This subscription is  New  Renewal