

# *The Weaver's Journal*

\$4.00

Volume VIII, Number 3, Issue 31

Winter 1983-1984

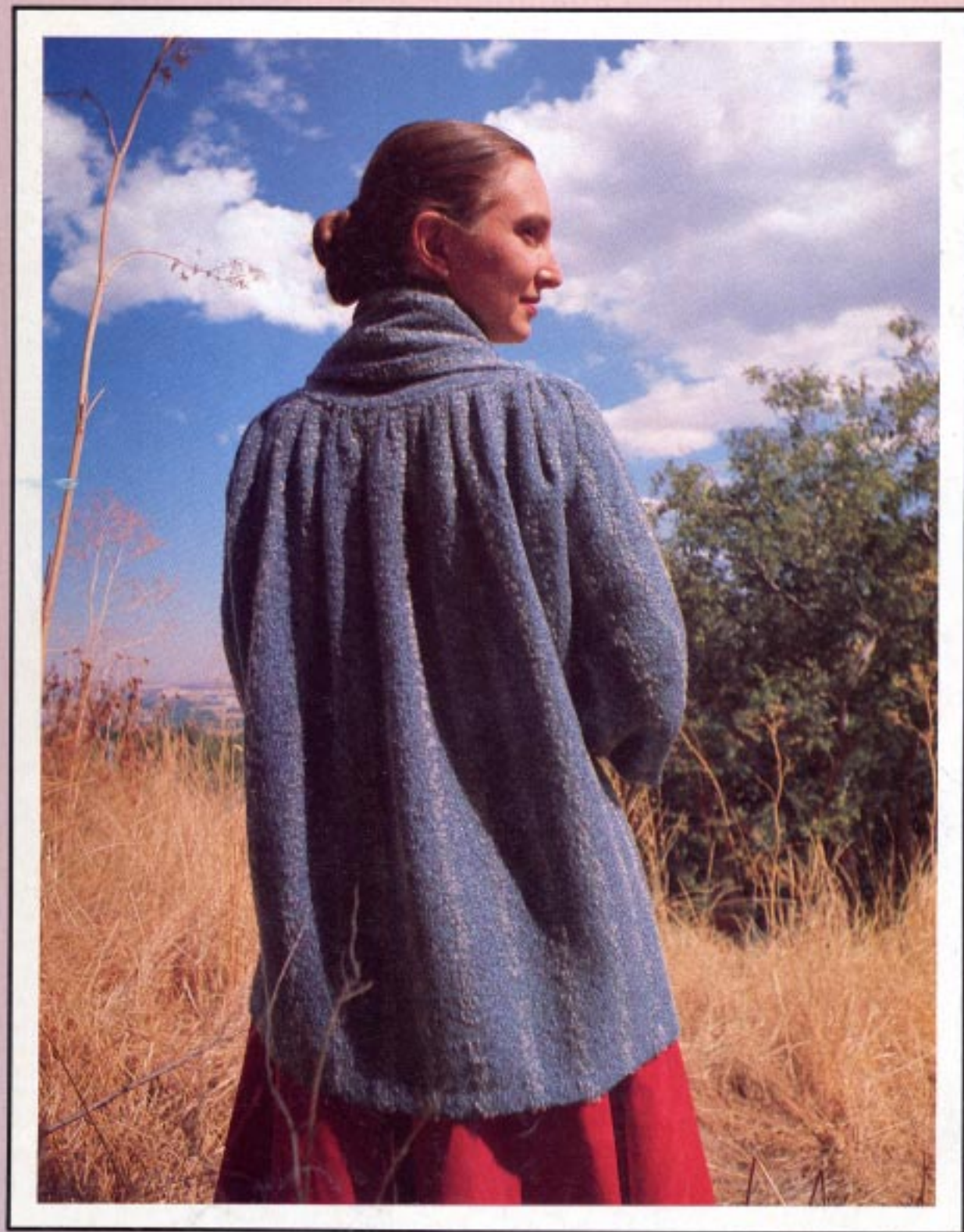

In the Swedish tradition . . .  
**Glimåkra Looms**

**Borgs Yarns**  
... since 1734

From rugs to fine fabrics . . . from beginners to advanced professional weavers . . . Swedish tradition means Glimåkra Looms and Borgs Yarns.

Send \$2.50 for our full-color catalog introducing our extensive line of looms and weaving accessories. Ask your yarn store to show you the Borgs sample cards — over 1000 separate color samples of wools, cottons, linens, and cottolins (50/50) . . . or send \$10.00 for your complete set.



**GLIMÅKRA LOOMS  
'n YARNS, INC.**

P.O. Box 16157-WJ7 • 19285 Detroit Road • Rocky River, OH 44116 (216) 333-7595

This picture also available as a poster. Please send \$3.95 for postage and handling.

# The Weaver's Journal

Quarterly Journal for Textile Craftspeople

Winter 1983-1984

Volume VIII, Number 3, Issue 31

ISSN 0160-3817

## CONTENTS

### ARTICLES

- 10 **Moroccan Cocoon**  
12 **Win's Sweaters**  
14 **Beginner's Tops**  
by Victoria Legerski  
16 **White Jacket**  
by Penny Grange  
16 **Recipe for Tanning Rabbit Fur**  
by Phyllis Clemmer  
18 **Weave and Knit Suit**  
20 **Weave and Knit Pullover**  
by Clotilde Barrett  
22 **A Seersucker Blazer**  
by Betty Johannesen  
26 **Fashion Trends**  
by Susan Hick  
28 **Adventures of a Computer Convert**  
by Doramay Keasbey  
32 **Computer Control of Tie-ups and Treading Sequence**  
by Richard Clement  
35 **The Irish Kinsale Cloak**  
by Una Jones  
39 **The Woven Skirt and Its Development**  
by Anne Poussart  
42 **Scandia Jacket**  
44 **Violet Vestment**  
by Roslyn Hahn  
46 **Happy Dress**  
by Elserine Sprenger  
49 **Discover Cotton Spinning**  
by Norma Ajeman and Irene Laughing Cloud Schmoller  
54 **A New Direction for the Art of Basketry**  
by Sharon LaPierre  
58 **Turned Summer and Winter Jacket**  
by Melinda Raber Johnson  
61 **Looming Thoughts**  
by Allen A. Fannin  
69 **A Jacket for Hiking**  
by Bettie G. Roth

- 74 **In My Country, It's Winter**  
by Agathe Gagné-Collard  
76 **Multishaft Overshot on Opposites**  
by Madelyn van der Hoogt  
81 **Shadow Weave Vest**  
82 **The Versatility of Four-shaft Twill**  
85 **Countermarche: Pure and Simple**  
by Joanne Tallarovic

### DEPARTMENTS

- 4 **Letter from the Editor**  
5 **Mail Bag**  
64 **Book Reviews**  
68 **Errata**  
72 **Product Reviews**  
73 **Product News**  
88 **Coming Events**  
89 **Classified—The Weaver's Market**  
90 **Advertisers Index**

*Cover photo: Handwoven Moroccan cocoon wrap of various blue acrylic yarns. See article on page 10. Photo by Pat Lawrence.*

**Editor and Publisher:** Clotilde Barrett  
**Associate Editor:** Mary Derr  
**Advertising:** Margaret Martin  
**Circulation:** Maxine Wendler  
**Wholesale Distribution:** Jan Stengel  
**Photography:** Jan Carter  
**Production:** Ellen Champion

**Typeset** by WESType Publishing Services, Inc.  
**Printed** by Mountain West Printing and Publishing, Ltd.  
**Color Separation** by Spectrum, Inc.

*The Weaver's Journal* is published on the first of each January, April, July and October by the Colorado Fiber Center, Inc., P.O. Box 2049, Boulder Colorado 80306. Telephone (303) 449-1170. Subscription rates are \$15.00 U.S. Currency for 1 year (4 issues) or \$29.00 U.S. Currency for 2 years (8 issues). Colorado residents add 3% sales tax. Outside U.S.A. 1 year \$18.00 U.S. Currency, 2 years - \$34.00 U.S. Currency. Copyright Colorado Fiber Center, Inc. 1984. Second-class postage paid at Boulder, Colorado and additional mailing offices. *The Weaver's Journal* USPS 384-210. The editorial committee takes no responsibility for the goods advertised in this journal. POSTMASTER: Send address change form 3579 to *The Weaver's Journal*, P.O. Box 2049, Boulder, CO 80306.

Although at the time of writing this letter the snow has not yet fallen in Colorado I am aware that this is the Winter Issue of *The Weaver's Journal*, the one featuring clothing, and that your calendar will say 1984 by the time this issue greets you at your studio. That is why it is time to look back at the old year and talk a bit about things that happened in the last 12 months that were important to handweavers. What stands out in my mind are the many conferences that were scheduled in 1983. As this was an off-year with *Convergence*, there were an unusually large number of places where handweavers could spend a few days or over a week, attending seminars, hearing lectures, taking workshops, visiting commercial exhibits and last but not least, chatting with friends.

Over the years I have attended quite a few of these happenings. Each time, I come back quite happy and satisfied. The lectures are always interesting, the presentations usually good and quite often outstanding, the workshops stimulating. The overall quality of the shows, demonstrations, commercial and guild exhibits are proof that there are a lot of dedicated weavers and suppliers out there who are willing to make a big commitment and share their love and dedication to fibers with others.

Although I was impressed with each conference that I attended in '83 and I enjoyed being there, I have a hard time talking specifically about one or the other. When I think back, I have the feeling that there was a "sameness" about all of them. They were all geared toward the same type of weavers, they were all directed to the same audience. Yet, weavers are such a diverse group. Are conferences in such large numbers going to be able to survive unless some new blood is pumped into such events?

Shouldn't there be a greater variety of conferences? The conference on complex weave structures held in July in Mineral Point, WI was a great example of such a successful diversion.

Can we conceive of yet other events to bring handweavers together? Well, let me talk about Indigo. It so happened that I was in France during the month of September, in the town of Lille, the center of the weaving industry of France (excluding the silk industry of Lyons). Twice a year the weaving industry and the Chamber of Commerce of the region sponsor Indigo, a coming together of handweavers, surface designers and manufacturers. The Fall dates were September 20, 21, and 22. It was a trade fair rather than a conference. It was a convergence of textile art and business, a meeting place of craftsmen and representatives from the industry.

Upon entering the international trade fair building where the activities were housed, one could visit a museum quality show of textiles which included pieces from all over the world, both from the past and present. A great tribute to the handweaver! Beyond this area were the booths. A variety of textile artists, designer groups, mills, educational institutions and manufacturers displayed and talked about their offerings.

Among the booths that were of particular interest to me were the demonstrations of looms. One was Swiss, the other French. They both had the option of electronic dobbies (computer aided shedding mechanism). I also enjoyed meeting a group of five weavers belonging to the "syndicat professionnel des tisserands de Bretagne". They displayed their portfolios of recent designs for the purpose of establishing communications, sales and commissions from the textile industry. Those weavers have small

production studios at home and live off the sale of their unique handwoven goods but are also interested in looking at the new horizons which can open up from contacts with the industry.

Textile schools were also represented. Not only did they show the excellent portfolios of their top students but took the opportunity to do some public relations work for their establishment and for their graduates.

Indigo is an important event for a certain sector of the handweavers and surface designers of France. Through this event they receive a great deal of publicity from radio and television. The textile industry was obviously very supportive of this fair. The host city showed its great appreciation to the members of the press by sponsoring a fabulous lunch. The vigorous participation of the press can make such events a vital part of the business of textiles, be it handwoven or industrial.

I am not suggesting that all our weaving conferences turn into meeting grounds for professional handweavers and industrial representatives. However, I do want to raise the question, "Why are our conferences all so much alike when weaving is such a multi-faceted craft? Should we not reach out for new ideas, new sources, new outlets?"

As always, I would really appreciate your comments on this letter. Would you be supportive of events in which handweavers with professional aspirations would be the stars of the show?

Let's pull together on the topic of conferences.

*Clotilde*

# MAIL BAG

Although I have been weaving about 8 years it has been an uphill battle of trial and error. It seems that most of the books written take it for granted that the reader knows all the basics, and the author plunges right into the middle, and the beginning weaver has to figure out how the author arrived at that point.

Fortunately, I have climbed many of these hills on my own but it has often been a struggle. *The Weaver's Journal* has helped make it a great deal easier. Thank you.

**Eleanor Raynor**  
Citra, FL

In Mail Bag of Vol. VII, #1, issue 29 you asked "what is a beginner"? I copied down this quote some time ago and I'm not sure if it was from HGA or the Assoc. of Northwest Weavers' Guilds.

... a Beginner can warp a loom in some fashion ... an intermediate weaver can read a draft ... an advanced weaver can make up drafts and is competent in several techniques.

**Barbara Roberts**  
Olympia, WA

In the beginning—both yours and mine—I must say that *The Weaver's Journal* was a big challenge for me. In fact, I have quite a backlog to explore when I am able to spend more time doing what I really want to in the way of handspinning and weaving. It is a great relief to see less "wall hangings" and more practical aspects that are available to help feed my habit and yet provide useful, beautiful articles for both home and clothing. Please, can we have more on fabrics for daily living—using finer yarns and easy to care for? Right now, I am a "hobby" weaver and am just starting to get serious about clothing. Most of the projects seem to be of the ethnic look—which is all right—but for those of us on the dark side of 50, we need less gathers and fringes. Since my time is limited, how about seeing fabrics that require singles (wool)—fabrics that could be designed for shirtings, blouses, dresses, jumpers, skirts, and so on—for the mature figure. More information about finishing these fabrics is also needed. I agree with that letter about proper tailoring; it doesn't take much to "scrap" a lot of time and material if the end doesn't enhance the means! Which brings up another point: I have quite a large investment (over a period of time) in my equipment and it seems to be getting more and more expensive "to feed my hobby." With all the interest in cottons, linens, etc., you would think that these items would

be more plentiful but it seems just the opposite. The suppliers are drying up and it is getting harder to find fine cotton yarns and woollens at reasonable prices.

For my two-cents worth about "harness/shaft", my personal preference is harness. Perhaps my rural background is the reason but harness to me implies holding (heddles) and denotes a more graphic description. Shaft, on the other hand, implies a more singular purpose. However, I do agree with those who feel that one word will probably never be adequate—so why not, "harness/shaft"? While it would be ideal to have a "one word vocabulary," past history makes that a little impractical—who is going to reprint all the texts? Speaking as one who is self-taught mainly, I struggled through all of the publications I could find, and while I know I still have a lot to learn, I find it worthwhile and challenging. And that is what keeps me weaving.

**Jeannette K. Robertson**  
Otego, N. Y.

I was too busy on my research to respond to *The Weaver's Journal* query on word preference, shaft vs. harness, but for the record: I back you 100% and thank you for bringing this little tangle to the picker.

I became aware of my own sloppy usage of harness long before I dared use "shaft" in conversation. The switch became mandatory with attempts to discuss the conversion of a jack loom to a dual-harness system.

Effective communication happens when the meanings of words are precise. The only way to converse or report in the progressively sophisticated world of handweaving is to be as exact as our language allows and to use *shaft* for "one heddle frame," and to reserve *harness* for the "system of shafts." The context will often reveal the meaning, but why cause confusion when clear meaning is immediate with precise usage?

I am distressed by the ethnocentrism displayed with arguments to keep using "harness" because "we're used to it, it's a common American term." It is too much like the attitude that if others want to communicate with us, let them learn English. If American handweavers are to be part of the world handweaving community, we had better be willing to acknowledge and use precise terminology.

**Kati Meek**  
Westerville, OH

Many of us learned to read drafts from right to left,—from right to left facing the loom. Old standards, Mary Black, Atwater, Davison, Tidball, are not going to be discarded regardless of what your magazine does. Anyone who understands basics should be able to understand all drafts.

Are the bulk of your subscribers industrial weavers or outside the United States? Is that the reason for catering to them?

If *The Weaver's Journal* makes radical changes, goes into computers (to any extent) dobby, counter-marche, it will of course lose so called hobby or leisure time weavers,—those of us who weave for our homes, clothing, and gifts.

**Ennice M. Lewis**  
Branchville, N.J.

*Editor: This is the type of feedback to "Let's Pull Together" that we hoped for. We don't want to dictate any special drafting system. We merely want to hear what people think about the question of terminology. We don't want to cater to any group. We just want to listen and find out what the present needs are and if these needs are being met. We believe there are people with countermarche looms who want to make clothing and gifts, too. But they have a hard time finding help.*

*Though we do have subscribers abroad, most of our subscribers are in the United States. A few may be industrial weavers, but most are not. It has long been our hope that industrial and hobby weavers can grow closer and benefit from a better understanding.*

I think it is high time somebody with great influence deals with the problem of terminology. You researched the whole concept very well and have come up with very sound answers. So far it has been equally difficult for beginning weaving students as well as teachers, not to mention publishers. I wish all weavers could agree with you.

Incidentally, I never thought I'd see the day a handweaver here in the U.S. agrees with me that treadlings should be read from the bottom up. You did a fabulous job explaining it. I believe everybody who is willing can learn new vocabulary and conventions for drafting. The sooner it happens the sooner all weavers in the U.S.A. will benefit.

**Ulrike L. Beck**  
Grand Island, N.Y.

Do you know of any programs written for drawdowns on the Commodore VIC 20?

**Jane Iverson**  
Britannia Beach, B.C.,  
Canada

*Editor: Do you have any weaving program for this computer? Know of anyone who does? You can write her at Box 97, Britannia Beach, B.C., Canada VON 1J0.*

Re Shafts v. Harness. Are not the shafts on which one threads the heddles suspended from the harness on a counter-balanced loom? Therefore, shafts indubitably.

**Jean Dauble**  
Christchurch S.,  
New Zealand

Having just now begun to catch up on my reading, I am joining the shaft-harness controversy.

I consulted Webster's Unabridged Dictionary and am unable to find justification for the use of *shaft*. *Harness* is defined as "The apparatus in a loom by which sets of warp threads are shifted alternately to form the shed. It consists of heddles and their means of support and motion." *Frame* is defined as "Any kind of a case or structure made for admitting, inclosing or supporting things."

For my part, my loom has a harness and as part of this harness, 8 frames.

**Emily Savidge**  
Columbia, CA

I have a gut reaction to say we should be in step with industry and the rest of the world. Although I always read drafts from the right and treading from the top down, I've discovered that my piece will usually match if I just turn it over. That's my comment! Thanks for providing the forum!

**Gail Troy**  
Shipman, VA

My main reason for writing concerns your drafting system. I guess because I'm a little ambidextrous, I have no trouble reading backwards, forward or upside down. I can also mirror read and write. I've learned to read drafts the Tidball way. I feel though that, logical as your system is, we will just have another system to learn with the adoption of your system. The addition of the arrows is a big help. Those arrows by themselves clear up all confusion for me. So perhaps the addition of arrows is really all that is needed,—at least for now.

**Diana Kinney**  
Albuquerque, N.M.

I just received the Summer issue and you write about a subject that I feel is taken far too lightly by most handweavers,—terminology. As more and more weavers have at some time contact with some unit of the textile industry, it is of paramount importance that they speak the same language as the industry. Not speaking the same language can cost a handweaver a lot of money. I remember a case where a handweaver offered the company I was then working for, some designs that were just what was needed to round out the line. The designs were exceptionally good and beautifully colored. As is usual, the weaver was asked for layout and specification of yarns used. The weaver said the draft (draw) was "Pins and Feathers" and the treadling Rosepath #3 or some such thing. The yarn was 2 ply and she guessed wool. She was unable to write either draft or treadling or weave, and all explanation that 2 ply did not express the size of the yarn, but only the ply, was fruitless. It was decided to buy the designs, but the weaver got only about 30% of what she could have realized if she could have supplied all the technical information required. We had to do a complete analysis of the samples and it turned out that the weave was an irregular herringbone and the yarn an acrylic. This was not an isolated case. I have come across many similar ones. Mill people are busy and don't have time to solve puzzles.

I am very much for using language, terminology and weave drafting as used by the textile industry and will again emphasize that, apart from simplicity, it will also be of economical advantage to handweavers.

**Walter Hausner**  
Hackensack, N.J.

I have studied with great interest your article, Let's Pull Together in the recent issue of *The Weaver's*

*Journal* and must admire the logic of the drafting method you recommend. However, there is one point at which I must take issue with you. Threading from left to right is reasonable and practical for left-handed weavers and for weavers who use string heddles, or who insert their warp ends singly from the rear.

Having learned weaving from the books of Atwater and Tidball, and being incorrigibly right-handed, it has always seemed quicker to use a hook in my right hand, reaching it through to pick up four warp ends at once, distributed between the five fingers of my left hand, then drawing in through the heddles one at a time, beginning with the right-hand end. If I were threading from left to right, I would have to reach across three intervening threads to pick up the one on the left, with resulting confusion. If I had started young, perhaps I could have learned to use the hook in my left hand (as the English use their table forks and Americans don't) but it's too late now.

I quite agree, though, that reading a treadling draft from the bottom up is purely reasonable, even though we read a page from the top down.

**Mariana Schaupt**  
Las Cruces, N.M.

I have been mulling over your article "Let's Pull Together." I feel you have addressed the problem very well and agree with most of your conclusions but disagree on a few. I agree with your most important point—to be practical, the weave draft must show the actual direction of the twill as it is woven.

But, I think we need to dig down deep and start asking the right questions, including why we use certain methods, and not worry about tradition. We sometimes forget that habits for one situation are not appropriate for another. Also, we need to be consistent in our methods, to eliminate confu-

sion. We must remember that WE ARE WEAVING, not reading a book. Weaving progresses from front to back, and if we are describing this in diagrammatic form on paper, we read from bottom to top, the method used by many Europeans and Berta Frey in her book, *Designing and Drafting for Handweavers*. I have recently adopted the method as illustrated in Fig. 5 of your article, except for the direction in which you read a draft. Really, what difference does it make? I read drafts in both directions depending on the situation. Your method of numbering the shafts and treadle tie-up eliminates any guess work.

**Peggy Hoyt**  
Walla Walla, WA.

**Shaft or Harness**—wish there were a better word. I don't think either one really is descriptive of the item in question. Black's was my first weaving book, so I have grown used to harness as the term to use. However, there are other matters that seem much more pressing than that name! For example, the thoroughness in writing weaving drafts and labeling everything.

**Ladella L. Williams**  
Portland, OR

First of all, the vote of harness vs shaft. I vote for shaft. Perhaps you should not decide "once and for all" now, for, should you decide on harness, usage may change enough that you will feel the need to change to shaft later. Perhaps you could let each contributor decide which word to use for his article. You need to be consistent in the articles you author, however.

As to why shaft, as interest in weaving becomes more international it becomes more essential to develop a common usage (just as eventually the States will convert to the metric system). Harness comes most comfortably to me because that has

been used almost exclusively in classes and in books I've used. I translate so many weaving terms from Norwegian to English that translating "shaft" to harness is no problem. However, shaft is most correct, and I feel that a less than correct term should not be encouraged. There is an upsurge in interest in opphamta (skillbragd in Norwegian) weaving, which uses two sets of shafts. Here the use of shaft becomes necessary, saving harness for a set of shafts. I liked Marian Hoskinson's statement that perhaps SS & D would follow *The Weaver's Journal* if you decide on shaft. I am trying to use shaft rather than harness in my teaching.

**Norma Smayda**  
Saunderstown, R.I.

Could someone please explain to this "ignorant one" what a Opphämta attachment is and does? Can it be used with all makes of looms?

**Marianne Davidson**  
Burnie, Australia

*Editor: Opphämta is a Swedish pattern weave with a plain weave ground and a supplementary weft floating over 2, 4, 6 etc. warp threads.*

*By using 2 harnesses, one weaving the ground weave (2 or 4 ground shafts) and one making sheds for the pattern weft (pattern shafts) and by putting long-eyed heddles on the ground shafts, one can weave these types of patterns with less shafts than on an ordinary loom. The harness containing the pattern shafts plus the pull system to lift these is called "opphämta attachment," and is only available commercially for Swedish looms. All looms can basically be equipped with a second harness. This harness can be as simple as a set of shed sticks or heddle bars. Thus opphämta type weaving can be done on all looms but requires a bit of ingenuity to set it up.*

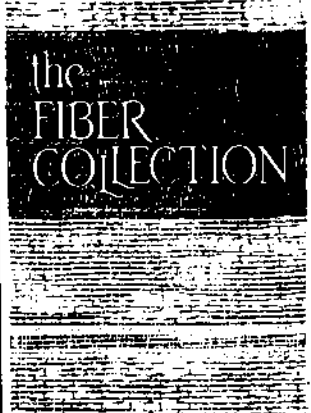

**the FIBER COLLECTION**

**SELECT YARNS FOR THE FIBER CRAFTSMAN**

*Fine Canadian Wool Yarn at AFFORDABLE PRICES. 27 Colors in 1, 2, & 3 Ply.*

**SAMPLE CARD \$1.00.**

**592 S. SWAIN AVENUE  
ELMHURST, IL 60126**

**J & D**  
**Highland Imports**

presents

**Fine Woolen Weaving Yarn  
from Scotland**

**Perfect for Tartans and Tweeds**

Send \$2.00 for sample cards (refunded with first order).

**P.O. Box 5497 • Richmond, California 94805**

ONLY \$3.95

**No — this is not a misprint!**

FOR a limited time we are reducing the price of our KLIPPANS yarns listed below:

**7/2 Tuna (Swedish Wool)**

Asborya • Mattyarn

Now specially priced at \$3.95  
per 100 gram skein.

We guarantee this to be the same high quality yarn that knowledgeable weavers have been using with full satisfaction for years.

\*\*\*\*\*

For full range of colors use your CUM sample card or order a set of KLIPPANS cards for \$5.00, postpaid.



**SCHOOL PRODUCTS CO.**

1201 Broadway, New York, N.Y. 10001 (212) 679-3516



## IMPORTED LINEN YARNS

— LARGEST SELECTION OF  
sizes, finishes, & colors

Send \$3 for complete linen sample  
and color cards

## WOOLEN YARNS

— handweaving worsted  
2/20s and 3/12s in 56 colors

— NEW HEATHER COLORS  
1.25 run imported  
100% virgin wool

Send \$1.50 for 2/20 and 3/12  
worsted color card  
\$1.50 for 1.25 run wool color card

## LECLERC LOOMS & ACCESSORIES

Quantity Discounts Available  
Dealer Inquiries Invited

TELEPHONE ORDERS ACCEPTED  
FOR IMMEDIATE SHIPPING

**FREDERICK J. FAWCETT, INC.**

Department W  
320 Derby Street  
Salem, Mass. 01970  
tel: 617-741-1306

WRITE FOR FREE CATALOG

## MULE SPUN

Rug Wool  
100% Imported  
Virgin Wool  
2 Ply - 150 yds./lb.

Available from your local weaving shops or send  
for list of stores carrying our yarns.

**HENRY'S ATTIC**  
5 Mercury Avenue  
Monroe, NY 10950  
Tel. 914-783-3930

Stores and Professional Weavers  
please send \$7.50 and a resale  
number for a sample set.

I wanted to share some information about your recent article "Let's Pull Together." I was asked to be Program Chairman of our Weaver's Guild this year, and I said that I would do it if we could get back to the basics. I planned a program that would include weaving terminology as well as drafting. I took along my copy of *The Weaver's Journal* and we discussed your proposal. I thought your article was quite timely as it seems that we all know the words and use them daily, but when asked to give a definition we fall short of an accurate explanation. I must say that our last meeting was one of the best I can remember. Everyone got involved and participated. It was very lively. I could see faces light up as people realized what certain terms meant.

We went through our drafting procedure along with threading, tie-up and treadling. We had 32 people present at the day meeting and 10 for our evening. As we discussed each of the terms and drafting conventions, I took a poll of opinions.

Treadling. Most agreed as to numbering the shafts from bottom to top. I learned to weave the Swedish method and I still count from top to bottom, however, I do teach it the other way, for reasons of sanity. As for reading the threading draft, we agreed 100% that we have all been taught to read from right to left. We must all agree with M. Tidball, the draft is written and read from right to left, the direction in which the loom is threaded. There were a few who thread from the center out, but only two who thread from left to right. Being right-handed, it seems to make more sense to start right, thread, and move the heddle to the right, while our body moves left.

Again, we are speaking as a group. I thought it might be nice to hear from a group, rather than just a few of us. The group felt good about being asked to give a little feedback.

**Joanne L. Tallarovic**  
North Olmsted, OH

*Editor: Individual feedback is great. Group feedback is wonderful! Keep it up.*

Here's my pet peeve, and remember, you asked for it in Mail Bag, Fall 1983. As a man who weaves, (ladies, you don't know the half of sex discrimination!) and one who sometimes threads the loom over a non-removable beam, I suspect I know why the term "breast beam" came to be. It is, however, quite inappropriate to me and my gender. How about "front beam?" After all, what's the one in back called? (Even to those who thread from the rear of the loom.) Besides, "chest beam" sounds perfectly absurd.

**Steve D. Marsh**  
Marshall, MI

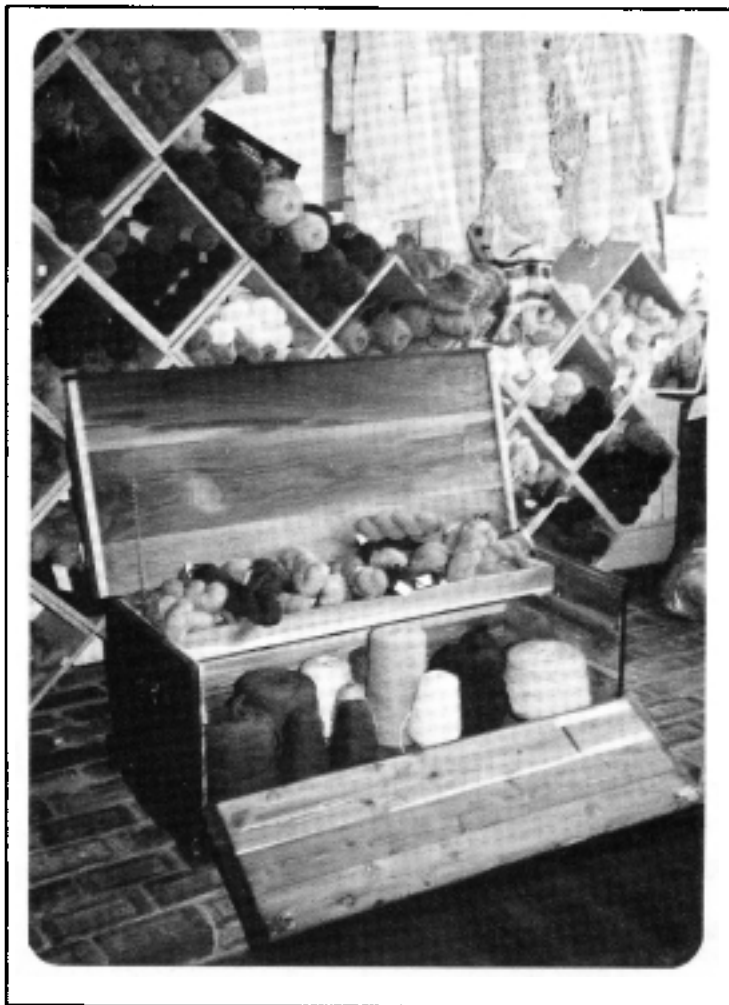

*Inventory control ideas from Isle of Ewe*

In Mail Bag last issue, you called for help on "inventory control" for weavers. Here are some ideas.

1. Go to your local yarn retailer and study his/her setup. They have been dealing with the same problem on a larger scale. Every shop has a different way of solving the problem.

2. I have three solutions for you:

a. The use of a cedar lined wool chest. It can be custom built to your specifications starting at \$299. Surprise! It doubles as a loom bench and we will match your wood. We purposely made it with no lock so as not to trap children.

b. Use a "wall of wool." These bins come in kit form of particle board at \$7 for a double bin (hardwoods start at \$29). They extend only one foot from the wall and can be stacked to the ceiling. Put it on an outside wall, and gain a foot of insulation for the coming heating season (we all know how wool insulates). If you don't want the bins, contact a milk distributor for those plastic crates. When they are placed on their sides and stacked, you accomplish the same thing.

c. Most weavers have a warping board. Our 15 yard board hangs on a wall and when it's not needed for

winding a warp, it holds pounds of yarns in hanks. We make ours from hardwood plywoods and it can be custom decorative painted. Isn't it about time someone made a pretty warping board so you can leave it out and use it, too? Use your raddle the same way.

3. Do you have a man's tie rack on hand? It's perfect for storing lots of small tapestry yarn skeins.

4. An old wooden ladder suspended from the ceiling when coupled with large size "S" hooks will hold more yarn than you believe.

5. A chunk of pegboard on the wall disappears behind colorful hanks and skeins of yarn. The pegboard may not be beautiful but when you cover it up you'll be happy.

**Isle of Ewe**  
Marshall, MI

I agree that we should have a common vocabulary as weavers. I have been weaving for a few years now, which isn't nearly enough for me, and understand most terminology. When I first began weaving, however, I was most confused, and see it now as I help beginning weavers. It

is not for this generation, but the next, why it should be made clearer.

Personally, I feel it will take quite awhile for everyone to use the set terms. And that is only if everyone cares about it and makes a point to correct themselves. I don't see any problems about accepting a new terminology as most weavers I've met are humble and open-minded.

I also agree with shaft as opposed to harness. And I feel that the word drawdown is specific in itself. Mainly because I do a lot of them and learned how under that term. But I, too, can change. However, I feel that it does have base, in that your term "weaving as drawn in" really implies there was a drawing of some type. If you changed "Draw-down" to "weave draft" perhaps you would also have to change "weaving as drawn in" to "weaving as drafted."

Anyway, I am all for "Pulling It Together" and will put effort into using the chosen terms.

**Peggy Clark**  
Bartonsville, PA

*Editor: I would like to point out to you a confusion that fed me to want to eliminate "drawdown." Draw-down refers to drawing, as children do with pencil on paper. Weaving as "drawn in" refers to using treadles in the same sequence as the threads have been drawn (pulled) through the eyes of heddles on the different shafts. You always weave as drafted, because the weaving draft is the representation of the weave on paper. You don't always weave as drawn in because this implies a very specific treadling sequence.*

We live in a fairly isolated area with little or no public transport, where a car is an absolute necessity. The community is very largely composed of retired and aging folks of limited means, hence we rely heavily on such craft magazines as we subscribe to, to keep us au fait with differing techniques.

Talking with some spinning, weaving friends recently, grumbling about increasing postage rates, etc. we agreed the time may come when we may need to cut down on our magazine subscriptions. We all agreed that we would be loathe to take this step, but should it become necessary, the one magazine we would not do without is *The Weaver's Journal*. Nor would we share it—each of us felt we must have our own copy as we rely on it so much for helpful instruction, variety of ideas, and excellent presentation.

**Bobble Almae**  
Smith's Lake,  
New South Wales  
Australia



# Loom a room



Add to your decor unique pieces spun from your own imagination and dexterity.

When you weave, you are not only making articles of handicraft but are also creating works with your own hands. It is a marvelous pastime and a great way of possibly profiting handsomely from the prices paid today for original ideas.



## Learning to weave easily

By attending a class or, at home, by following instructions contained in our "Weaving Guide". Please indicate your preference, and we'll gladly send you all the necessary information.

Mail this coupon as soon as possible

The largest weaving loom manufacturer in North America.

# Leclerc

SINCE 1876



Nilus Leclerc Inc.  
P.O. Box 69, L'Isletville,  
Québec  
G0R 2C0 Canada

Please send me your latest catalog "Looms and Accessories". Enclosed, is \$1.00 to cover postage and handling.

Please send me:

- The list of schools in my region giving weaving courses.
- The list of Leclerc dealers giving weaving courses.
- Your "Weaving Guide" for which I include \$1.00.

Name \_\_\_\_\_

Address \_\_\_\_\_

City \_\_\_\_\_ Zip Code \_\_\_\_\_



Acrylic Moroccan cocoon woven by Penny Grange

## MOROCCAN COCOON

This very soft, comfortable garment is woven in plain weave, and it is a good project choice for weavers without sewing skills. The wide scarf that forms the collar can actually be lifted up over the head as a hood or veil against bright sun and wind. Light and dark blues in stripes blend gently with the flowing folds of the gathered back. Penny Grange, the designer, has also woven a variation of the same pattern in white.

**Warp:** Acrylic loop in light blue; acrylic novelty in darker blue.

**Color order of the warp:** Alternate a wide stripe of dark blue and a narrow stripe of light blue.

**Weft:** Brushed acrylic in blue.

**Sett:** 10 epi (40/10 cm)

**Width in the reed:** 20" (51 cm).

**Threading, tie-up and treadling:** Plain weave.

**Length of the warp:** 6 yds (5.4 m). This includes a loom allowance of 27" (69 cm).

**Washing:** Wash by machine, 5 minutes on gentle cycle, and dry in dryer with a sheet of fabric softener.

**Shrinkage:** Minimal shrinkage in width. The finished width of the fabric is 19½". Shrinkage is about 2" per yard lengthwise.

### ASSEMBLY

- First stitch the fabric around the cutting lines; then cut as follows:

Two 31" (79 cm) lengths for the back.

One 76" (193 cm) length for scarf-fronts.

Two 22" (56 cm) lengths for sleeves.

- For the back, cut one of the 31" (79 cm) lengths into three strips. Sew one of these strips to each side of the other uncut 31" (79 cm) length of fabric. (Fig. 1). (The left-over strip may be used for cuffs or sash.)

- Gather the back across the top, to a 14" (36 cm) measurement.

- Mark the center of the scarf length, and the center of the gathered back. Stitch them together across the top back. Reinforce the machine stitching as this seam takes quite a bit of strain. (Fig. 2).

- To cut the tops of the sleeves to a point: Make a mark 8" down from the top edge on each side. Then mark the top center of the fabric. Fold on the lines from the center point to the side points. See Fig. 3. Mark the fold lines. Allow ½" (1.3 cm) seam, stay-stitch and then cut.

The long top of the sleeve design compensates for the narrow back section. This is a semi-raglan sleeve. The top of the sleeve runs up onto the shoulder.

- Set in sleeves before the side seams are sewn up. Make sure the top point of the sleeve is exactly where the back section and scarf fronts separate (Fig. 2).

- Sew from the bottom of the sleeves right down to the bottom of



Jim Lawrence

the robe, making sure the underarm sleeve seams are in alignment. Hem the scarf fronts or if preferred, leave selvages exposed.

- Bind all the cut edges with seam lace or seam tape. Hem the bottom of the garment and the sleeves.

### VARIATION IN WHITE

The interest created by the stripes in the blue version is replaced here by nubby surface texture. Penny Grange used a cotton flake yarn for the warp, with a heavier cotton novelty yarn for the weft.

For this version, one of the two back sections is cut lengthwise down the center. Sew one section on each side of the uncut length keeping the selvages together. Gather the back to an 18" width.

The sleeve caps are 5" (13 cm) high.

Ply four strands of heavy silky white yarn into a rope for trim. Handsew across the back seam before the sleeves are set in.

Cotton variation of cocoon by Penny Grange

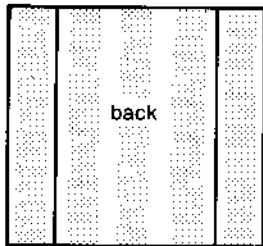

FIGURE 1

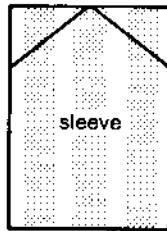

FIGURE 3

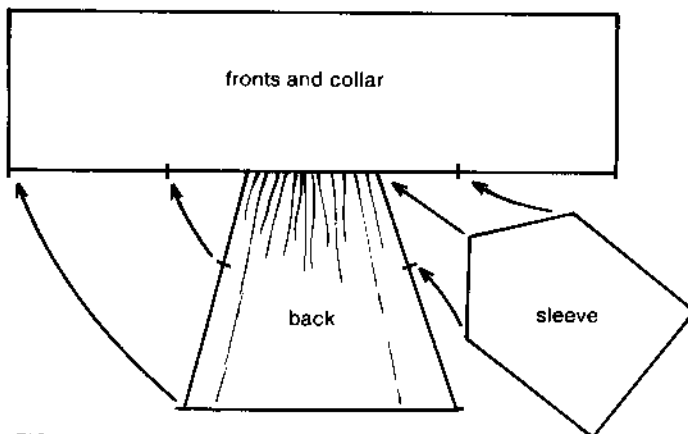

FIGURE 2



### IF YOU WEAVE . . .

The Mannings have everything you need !!!

**Instruction** \* Resident instruction in all types of weaving. Special classes for beginners.

**Looms** \* Leclerc - Gallinger

**Rug Yarns** \* Over 300 colors 2-3-4-6 ply. Special skein wool for vegetable dyeing.

**Fine and Fancy Yarns:** cottons - linens - mohairs - wools - novelties - chenilles

**Name Brand Yarns By:** CUM, Lily, Fawcett, Reynolds, Plymouth, Stanley Berroco, Harrisville, Kolmes

### ORDER TOLL FREE DIAL

**1-800-233-7166**

**In Pennsylvania Call**

1-717-624-2223 and receive 1.00 phone allowance on orders over 15.00

Catalog and Rug Wool Samples - .50

**THE MANNINGS**  
R. D. 2  
East Berlin, PA 17316

# WIN'S SWEATERS



In the year of relaxed easy over tops, sweaters, V-shapes and simple T-shaped tops, Winifred Shaw's woven *sweaters* are the perfect project. Her designs present the theme of comfort and simplicity to the handweavers who don't like to sew. The pattern requires a large square of fabric, folded diagonally from corner to corner to make a triangle, so that the bias line of the material runs down the center front and back and across the shoulders and bustline. The fabric stretches where necessary so the handwoven fabric fits and hangs well. Very little fabric is wasted or unused. Fabric squares cut in triangles also form the sleeves and sides. Wool and loop mohair make this a cozy garment in chilly weather.

The fabric is designed with stripes and bands of darker color on all four sides of the square. They form an attractive V that matches the neckline. It is woven in plain weave. The instructions are given for a size large/extra large garment.

**Warp:** 2 ply wool in plum and lilac (Harrisville Designs, Harrisville, New Hampshire); looped mohair in lavender.

Every other thread is a lavender mohair. The plum colored stripes are 6" wide on a lilac background.

**Warp color order:** See Fig. 1.

**Weft:** 2 ply wool in plum and lilac (Harrisville Designs).

**Weft color order:** See Fig. 1.

**Sett:** 8 epi (30/10 cm)

**Width in reed:** 42" (107 cm). This will weave 36" squares after the fabric has been finished.

**Total number of warp ends:** 336

**Length of the warp:** 3 yds. (2.7 m)

**Threading, tie-up, and treadling:** Plain weave (See Fig. 1). The woven yardage and the cutting diagram is shown in Fig. 2. Cut out the pattern pieces and the neck openings and zigzag the cut edges.

**Construction of the garment:** To help understand how to construct the garment, make a paper pattern using graph paper and tape the pieces together. See Fig. 3. As a means of determining your own size and gaining experience in sewing, you might first construct a summer weight garment of light weight commercial fabric.

**Assembly:** Fold the large square diagonally with the right side of the fabric on the inside. Using  $\frac{1}{8}$  inch seam allowance, stitch seams at A and B. Press all seams open as they are stitched.

Join the right side triangle to the front and back of the large square at C and F. Then join the left side triangle to the front and back and D and G. Stitch the right and left side triangle together at the center front, E, and the center back, H.

Join the right sleeve piece to the

large square at I and J, and complete the sleeve by stitching the seam at K. Join the left sleeve to the square in the same manner. Use a  $\frac{5}{8}$ " seam allowance. The sleeves are finished with a one inch hem using seam binding. The bottom edge of the pullover is a selvedge edge and may be left unhemmed.

Clip the seam allowance at the corners of the neck opening. Prepare it for the woven collar by turning  $\frac{1}{2}$  inch of fabric to the front side. Baste in place. The collar is woven separately.

## THE SEAMLESS COLLAR

**Warp:** 2 ply wool in lilac (Harrisville Designs)

**Weft:** 2 ply wool in lilac (Harrisville Designs)

**Sett:** 10 epi (40/10 cm)

**Width in the reed:** 2.4" (6 cm)

**Total warp ends:** 24

**Length of warp:** 4 yards

**Threading, tie-up, and treadling:** Plain weave

**Weaving the collar:** See Fig. 4. The first woven piece, section A, is  $7\frac{1}{2}$  inches (19 cm) long. A smaller size would require shorter lengths in the sections, so please check your pattern size at this point. Six inches of open warp for fringe is left at each end. Section B is identical to section A. Mark the end of the two pieces with two shots of yarn of a contrasting color.

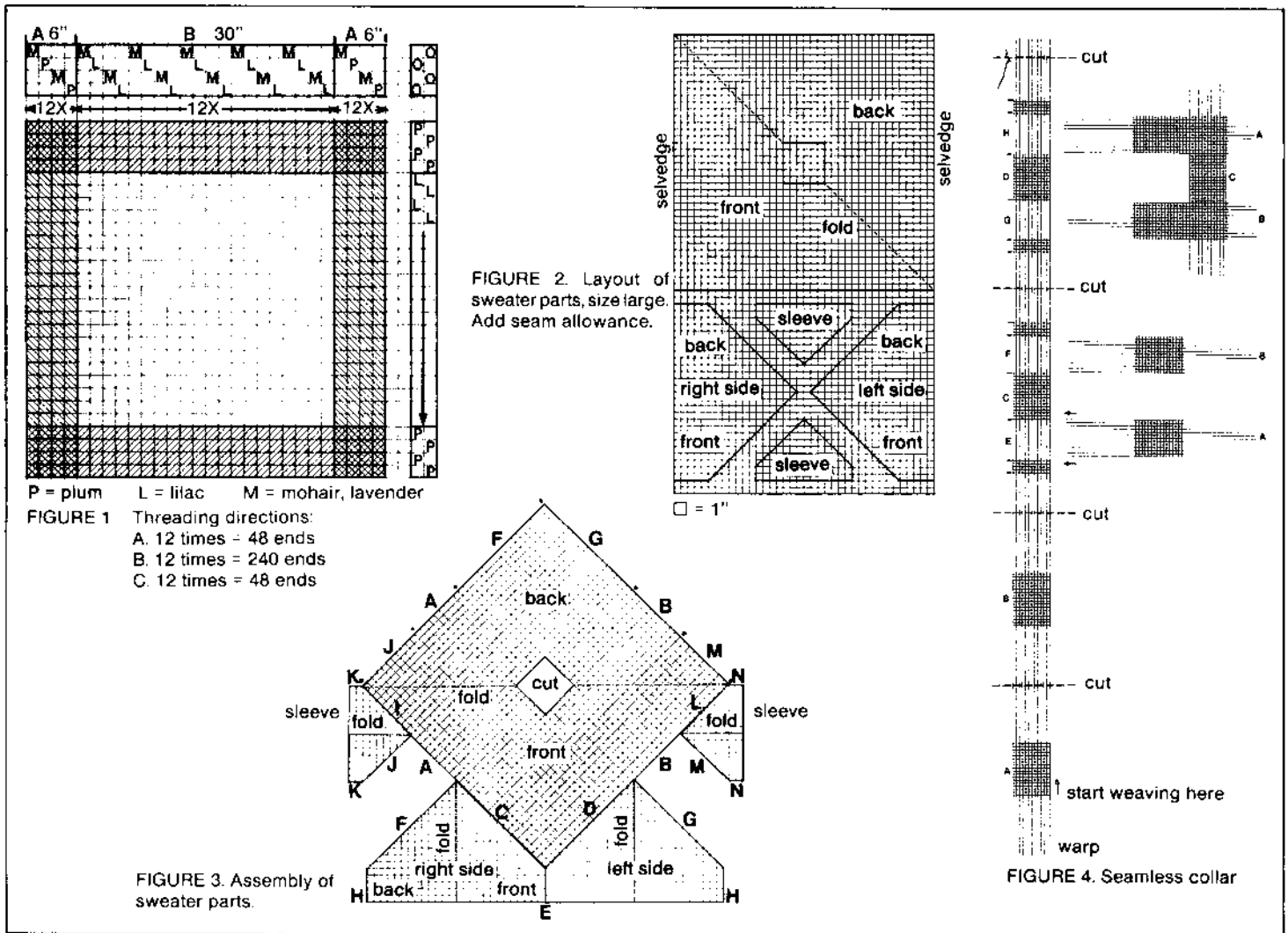

FIGURE 2. Layout of sweater parts, size large. Add seam allowance.

FIGURE 1 Threading directions:  
 A. 12 times = 48 ends  
 B. 12 times = 240 ends  
 C. 12 times = 48 ends

FIGURE 3. Assembly of sweater parts.

FIGURE 4. Seamless collar

Cut sections A and B off the loom and then cut them apart. Retie the warp to the apron.

Leave 4 inches of unwoven warp for fringe. Weave two shots of yarn and cut the weft. Position section A perpendicular to the warp. Now the fringe of section A is used for the weft. Remove the two shots of contrasting yarn; weave each end of the fringe of section A as a weft shot for section E. Group and tie every four ends of weft together in an overhand knot to hold the warp in place.

Weave section C. It will need to be approximately 7 inches long, with the weaving under tension. Then the fringe of section B is woven in as weft, just as with section A.

Weave four additional weft shots to hold the weaving in place. These will be removed later when the collar is attached to the neckline.

Allow four inches of fringe, and cut off the loom. Retie the warp to the apron again.

Some weft picks will have to be removed on sections A and B so both are the same length as section C. Allow for four inches of fringe; weave a few shots; then weave the fringe of section B into the warp at G, one at a time as before. Weave seven inches at D. Weave the fringe of A into the warp at H. Add a few more weft shots. Allow for four inches of fringe and cut from the loom. Wash and press.

**Joining the collar to the neckline:** First pin the collar in place and baste it to the garment. Pull each piece of fringe to the wrong side with a large tapestry needle or a crochet hook. Knot the ends together close to the fabric and trim off the excess. Hand stitch the collar to the sweater. Remove the basting and press.

If your fabric is lightweight, a 9 inch square of material could be used for a neck facing instead of a woven collar.

### NOTES ON FINISHING THE SWEATER

The machine washed fabric is soft, thick, and fuzzy. While wet, it was hung over a shower rod; the raw edges were pinned together, and a rod was inserted between the two layers with weights hung from each end. The fabric was blocked so that each side of the square measured 36 inches when dried.

The mohair yarn shrank more in the washing than the Harrisville yarn, so the fabric had to be blocked. It is essential to know how much the fabric will shrink when it is washed to accurately estimate the number of inches to weave in each section of the design so a true square is the end result.

## NOTES ON NARROW LOOMS

The same sweater may be made from a narrower strip of fabric. See Fig. 5. Four squares of equal size are sewed together to form the large square of Fig. 6.

The right and left side pieces are cut from one square so the bottom edge of the garment is bias. If the side pieces are joined one inch lower than the center, there is enough fabric to hem the garment with seam binding. The pattern pieces for the sides and sleeves could be shifted on the fabric to take advantage of the selvage edges. See Fig. 7.

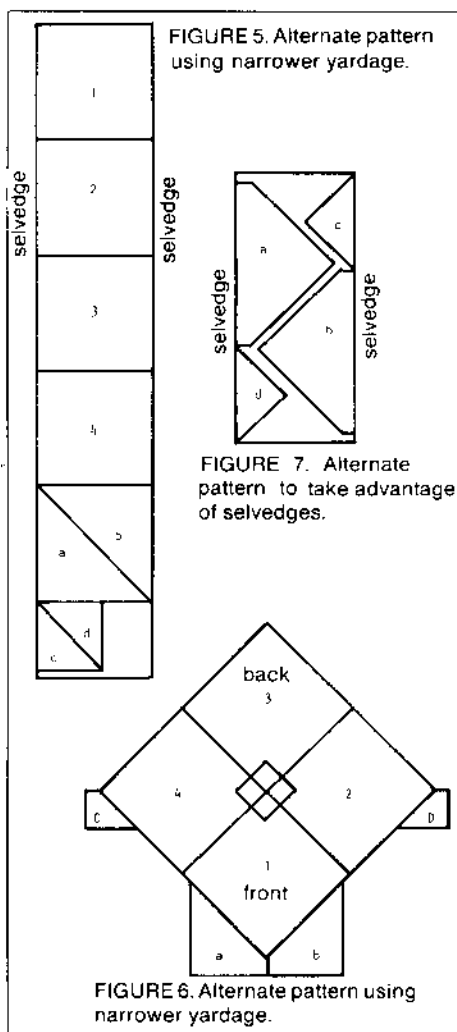

**ABOUT THE DESIGNER:** Winifred Clark Shaw holds a BS degree in home economics education from Iowa State University and a MFA in metalsmithing and weaving from the Cranbrook Academy of Art. She has been teaching both jewelery-making and weaving as an Assoc. Prof. of the Arts at the University of New Hampshire, Durham, since 1954. She has exhibited her work locally, state-wide and throughout New England for many years. ■



From left to right; grey-green wool top, handspun weft jacket and rust tweed wool jacket.

## BEGINNER'S TOPS by Victoria Legerski

How many tablerunners, placemats, pillows, etc. have you woven—afraid to try a garment for which you have to cut into the fabric? Here's a good pattern for beginners. It is a simple plain weave top with a twill yoke. The twill lines run outward, toward the shoulders for a broad shouldered look. If you prefer a narrow shouldered look, change the direction of the twill lines by reversing the treadling.

This is a basic pattern which can be adjusted by making the side panels wider or narrower or by changing the width of the warp. Here the sleeves are three-quarter length; they could easily be lengthened or shortened. The following weaving instructions will make three tops, woven on the same warp but with different wefts.

**Warp:** 1,590 yds (1,431 m) tan 3/22 wool worsted (Nehalem from the Oregon Worsted Co.); 265 yds (238.5 m) of each of the following selection of yarns: yellow variegated worsted, charcoal tweed singles, medium brown slubby, and dark brown ratine (see Photo 2).

**Weft:** Top #1: 300 yds (270 m) white 1 ply handspun. Top #2: ½ lb. rust tweed singles. Top #3: ½ lb. grey/green shetland type wool.

**Color order of the warp:**

ratine										1	1 1 1 1 6 10
yellow									1		
med. brown								1			
charcoal											
tan	1	1	3	1							
	← repeat →										working ends per repeat

**Total number of warp ends: 246**

**Sett:** 12 epi (50/10 cm). At each selvedge, double-sley for three dents.

**Width in the reed:** 19.5" (48.8 cm)

**Length of the warp:** 12 yds (10.8 m) This includes loom waste.

**Threading, tie-up, and treadling:** See Fig. 1 for a 4-shaft loom and Fig. 2 for an 8-shaft loom.

**Layout for one garment:** See Fig. 3. Weave each garment according to this layout and separate back, sleeves, and sides by weaving in markers with contrasting yarn.

**Washing:** Wash on gentle cycle in warm soapy water agitating for 5 minutes. Rinse by hand. Spin out excess water. Hang to dry. Steam press.

**Finished size:** Three pieces 17" x 3.5 yds (42.5 cm x 3.1 m)

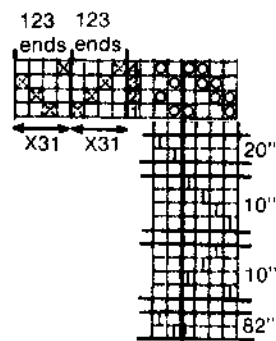
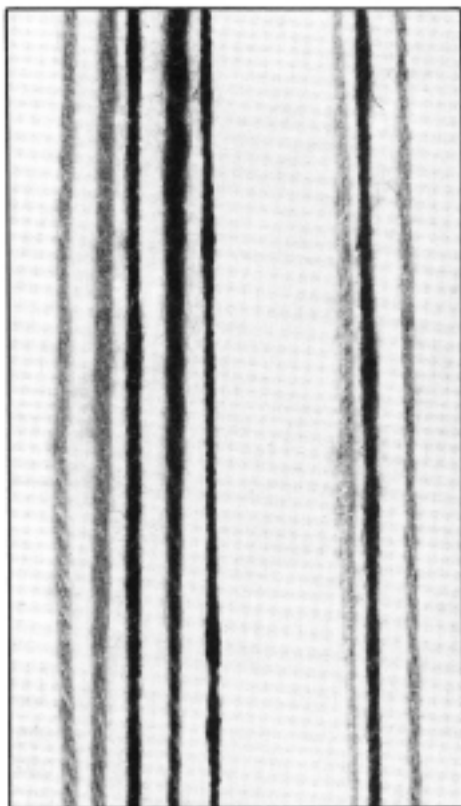

FIGURE 1

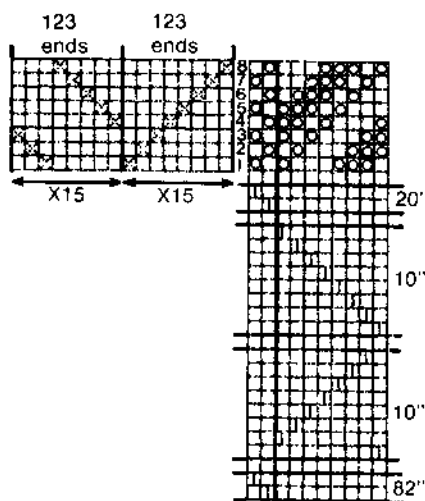

FIGURE 2

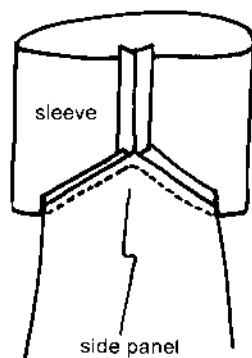

FIGURE 4

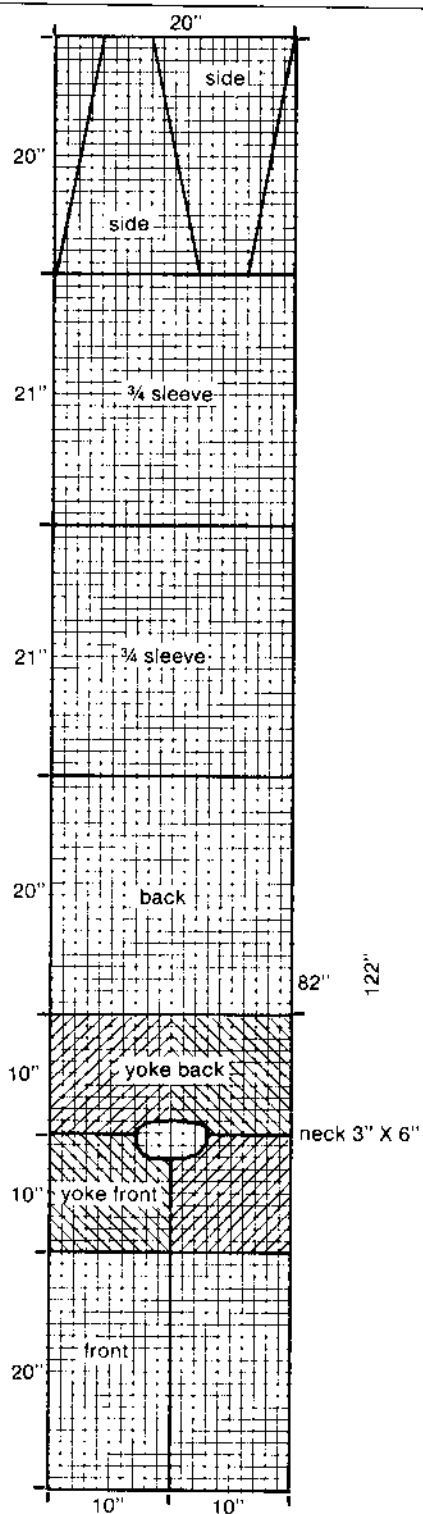

FIGURE 3

**Finishing:** Zigzag twice along all cutting lines, using 2 different types of zigzag. The circle for neck is 2½" (6.3 cm) lower than the shoulder line in front; 1" (2.5 cm) lower in back and 6" (15 cm) across at the shoulder line. The shoulder line is the point where the twill reverses. Side panels are 2" (5 cm) wider at the bottom than at the top

to give some flare to the jackets.

Fold the sleeves in half and sew sleeves to side panels as shown in Fig. 4. Press seams open. Sew front and back panels to side sections and sleeves; match shoulder line to center of sleeve; match panel-sleeve seam to twill beginning. Press seams open.

Try on the garment and adjust the hemline and sleeve length. Before turning up the hems, finish raw edges with crochet, Seams Great, or seam binding. Instead of turning up the hems, the edges may be finished with two rows of single crochet. Finish the front and neck with 4 or 5 rows of single crochet, making buttonholes or loops. ■



## WHITE JACKET by Penny Grange

With a good imagination and a few tricks, a little bit of yarn can go a long way.

I had a limited amount of wool yarn in natural white purchased in New Zealand. This is how I made a white jacket out of it.

**Warp:** Wool yarn, in natural white

**Weft:** Same as warp

**Sett:** 8 epi (30/10 cm)

**Width in the reed:** 22" (56 cm)

**Length of the warp:** 4.5 yds. (4 m). This allows 1 yd. (.9 m) for loom allowance.

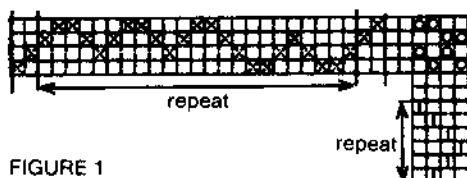

FIGURE 1

**Threading, tie-up and treadling:** Plain weave and extended point twill.

**Weaving instructions:** I wove 3 yds. of twill according to the draft of Fig. 1. Then I cut it off. This was enough for the front, back and sleeves. The cuffs could be woven in pattern or plain weave. I rethreaded the warp for plain weave. I threaded a warp just wide enough for the collar. Then I used a warp just wide enough to weave the two front bands (two strips requiring two shuttles). The button holes were woven as slits in the front band, 4" to 5" apart. The ends of the collar and facings were needle woven back in.

Fabric with a width of 22" is not quite wide enough for a jacket so I added side inserts. Therefore I joined the back to the front with loose double crochet.

I didn't have a pattern. I cut it in lengths and built it on me in front of the mirror. ■

## Do Your Own Tanning

### RECIPE FOR TANNING RABBIT FUR

by Phyllis Clemmer



### MATERIALS

1 cup ammonium alum  
2 cups table salt  
Enough water to cover hides

Soak the hides in this solution for three weeks, stirring each day. Wash hides in soap and water. Rinse, squeezing out the water. Flesh the hides, starting from the bottom (tail end). Dry overnight, hair side up. Turn hides over and cover the surface with a coat of oil. (I use baby oil or Neatsfoot oil). Stretch. Let the hides dry slowly. Work the skins every hour or so during the drying. Do this by stretching the hide and by rubbing the skins between the hands as if one were hand-washing them. ■



# We Make Yarn The Old-Fashioned Way. Naturally.

JaggerSpun offers you the finest quality coned yarns available anywhere. All 100% worsted spun wool or wool-silk. In a variety of textures and blends that are exclusively ours. Naturally. And in a palette of colors sure to please the eye of any artist.

Don't be sheepish — send for our complete yarn sample collection and put our wool in front of your eyes.



**Yes!** Send the JaggerSpun Collection. Enclosed is \$2.00 — which will be credited to my first purchase.

Name

Address

Zip

Send to: JaggerSpun, Water St., Springvale, ME 04083

used was 2 ply wool and the same yarn in singles in three colors: blue, dark green, and dull gold. After the coat was finished, I still had a length of fabric 45 inches long and the full 18 inch width left over. It was too much to waste, so I let my subconscious work on it for a while, and eventually realized that it was enough to make the front and back of a jacket for myself, if I used something else for the sides, sleeves, and collar."

"Since I was a compulsive knitter long before I started weaving, and usually design my own sweaters and knitted dresses, knitted sections were the answer. I had some of the yarn in the fabric left, but it was a bit scratchy, so I didn't want to have it next to my neck. Besides, most of the leftover yarn was the singles, and I wanted a heavier knitted fabric for a jacket. I carried a scrap of the fabric in a plastic sandwich bag in my purse for at least a year, looking for a knitting worsted or similar wool yarn in a shade of green that would blend with the fabric, before I finally found some Brunswick German-town yarn, in a blending color, in a sale bin!"

**The jacket assembly:** The jacket fronts and back are cut with a slightly tapered waist, and a deep V neck. I did it the easy way, and used a commercial pattern; Vogue 1791. I used the lapel roll line and the center front line as *seam lines*, not cutting lines. The front edges of the fabric should barely meet at the center. Two fronts and one back were cut from the handwoven fabric, and also from a commercial lining fabric. After sewing the shoulder seams, the two layers were seamed together and turned right side out. The knitted sleeve and side sections were sewn by hand to the side edges of the jacket, sewing the pocket extension to the lining only, and leaving the jacket edge free for the pocket opening.

The collar and front bands were sewn on next. The collar had to be eased to fit the smaller neck edge, but having the collar a bit larger



Weave and knit suit created by Mary Bronson

## WEAVE AND KNIT SUIT

The richness of textural variation and the appealing sporty lines of this jacket speak clearly of Mary Bronson's ingenuity. She designed this outstanding piece as a solution to finding a good use for a small amount of yardage left over from another project. Carefully matching the yarns, she created a broad knitted collar, knitted sleeves and sides that blend with the handwoven fabric. Then Mary designed

a color coordinated skirt using leftover yarns from both the yardage and the knitting.

Here is her description:

"I like to weave clothing, and prefer cut-and-sewn garments over loom-shaped, because of their more flattering fit. The first thing I wove when I got my table loom a few years ago, was yardage to make my husband a sport coat. The yarn

makes for a more graceful fit. Buttons were made by working 12 single crochet around a half-inch plastic ring; then running the yarn through the back loop of each stitch, and pulling up tightly.

**Knitting the sleeves:** The sleeves and sides are knitted without seams, because I don't like to sew knitting. I used a total of 4 skeins of Brunswick Germantown yarn. The stitch gauge is 4½" to one inch, on number 8 needles. The sleeve is started at the wrist, on double-pointed needles. Cast on 32 stitches. Work K 1, P 1 ribbing for 2½ inches. Change to stockinette st, increasing 12 stitches in the next row. Continue in stockinette st, increasing 2 stitches at underarm every 1½ inches ten times (64 stitches). Work even until 18 inches from starting point. Shape cap: Cast off 6 sts (3 each side of center seam). Then decrease 1 st each side every other row until 26 sts remain. Decrease 1 st each side every row 6 times. Bind off remaining 14 stitches. Work the decreases one stitch from the edge, to leave a smooth edge for sewing.

**Knitting the jacket sides:** Starting 2" above cast off sts of sleeve, from the right side, pick up 26 sts from the underarm part of the sleeve. Work in K 2, P 2 ribbing, shaping the underarm with short rows. To do this, K 3, wrap yarn around the next stitch, turn and work back, slipping the first stitch. Repeat twice, working 6 stitches the second time, and 9 stitches the third time. Work in pattern across entire row, then shape the second side the same way. Work even until 5½ inches from the underarm, measuring at the center. Cast on 18 stitches at the front edge for a pocket. Continue working side in ribbing, and pocket in stockinette stitch until pocket measures 4" from cast on edge. Bind off pocket section, and work side section only until 10½ inches from the underarm. Bind off. Work second side and sleeve to match, reversing pocket shaping.

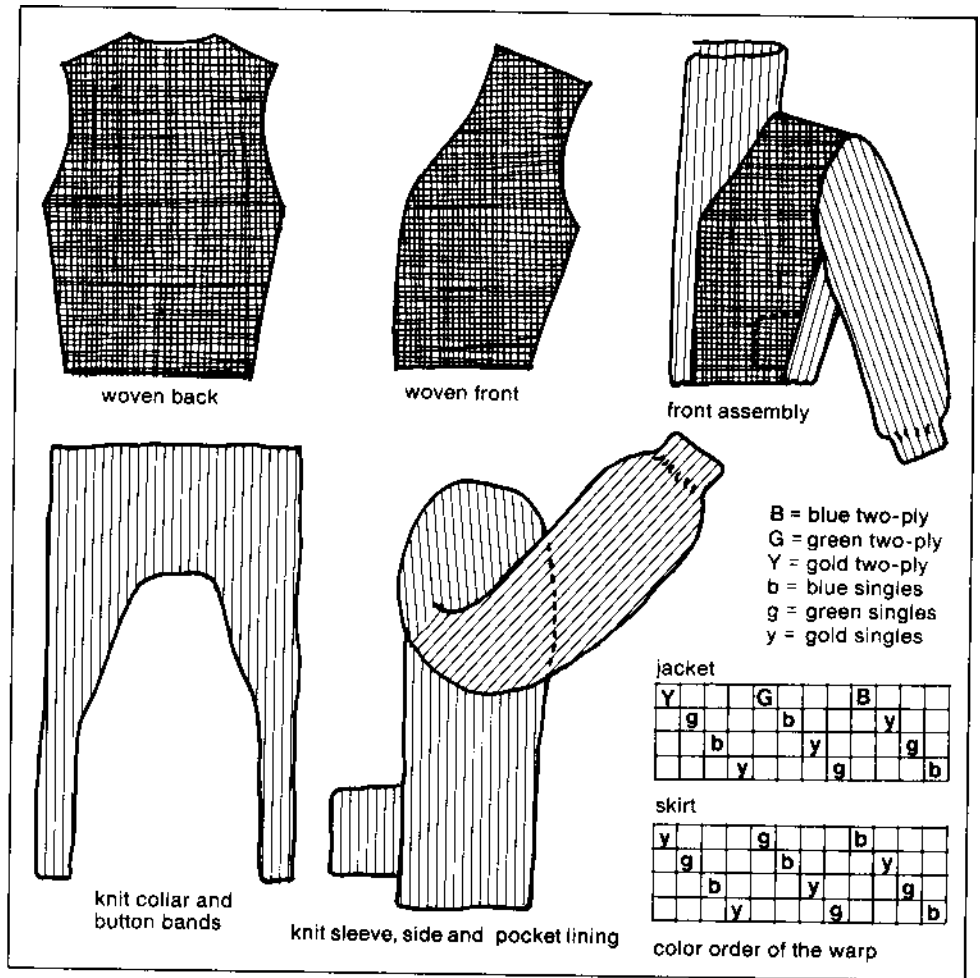

**Knitting the front bands and collar:** To begin the left front cast on 5 stitches, and work in K 1, P 1 ribbing for 12". Then start widening for the collar by increasing 1 st on the right side every fourth row 8 times, then every second row 9 times (22 stitches), ending on an inside edge. Place stitches on a holder, and place markers for 5 buttons, having the top button at the first increase row, and the last button 1" above the bottom. Right front: Work as for the left front, reversing the shaping, and working buttonholes opposite the markers.

I experimented, and developed a firmer buttonhole. To make it: On the right side, K 1, P 2 together and K in the back loop of the second stitch before dropping it. Bind off 2 stitches, K 1. Next row: P 1, K 1 in the first stitch, cast on 1 stitch, K the next stitch with the stitch below, P 1. End the right front at the front edge. Do not cut the yarn.

For the collar, work across the 22

stitches of the right front, cast on 45 stitches for back neck, work the 22 stitches of left front. Continue in K 1, P 1 ribbing until 3½" from cast on stitches. Bind off *loosely*.

Since I'm short, I don't want contrasting tops and bottoms, so after the jacket was finished, I used the leftover yarn to weave skirt material. The warp is the wool singles, following the same color sequence as the jacket, and for weft, I separated the Germantown yarn, and used just 2 plies. I used my favorite straight skirt pattern, Vogue 2283.

Both the warp of the vest and skirt were set at 12 epi (50/10 cm) and woven in plain weave.

*ABOUT THE DESIGNER:* Mary E. Bronson has always been fascinated by all the textile crafts, beginning to learn them before she started school and continuing while raising her family. She enjoys making clothes using every technique she learns. Currently she is teaching weaving for the Northwest Iowa Weavers and Spinners Guild. She has also taught tatting. Mary is a member of the Northeast Iowa Weavers and Spinners Guild, the Iowa Federation of Weavers, the Handweavers Guild of America, and the International Old Lacers. ■



## WEAVE AND KNIT PULLOVER

by Clotilde Barrett

Take a look at the fashion predictions for this season and you will see references to the sweater look, bold patterns, oversized garments, stripes, and luxurious fibers. Then go to your loom and to your knitting needles, and dream about making the perfect garment for the year. This "weave and knit" chenille pullover could almost be called a handmade classic. It is simple and clean, and yet may well be the most fashionable and versatile garment in your wardrobe. Wear it with or without turtlenecks; wear it over slacks or skirts; wear it as one of the many layers of clothing that you will pile on and pile off when it gets colder or

warmer; wear it with a long hand-woven scarf.

### THE WOVEN CLOTH

**Warp:** 2/16 off-white worsted (Wil-lamette from Oregon Worsted Co.)

**Weft:** Rayon chenille (Silk City Fibers approx. 1,300 yds/lb.) 1¼ lb. each of white, dark, and beige. This amount of chenille is sufficient to also knit the sleeves.

A very fine bronze colored metallic thread to intersperse throughout the dark chenille band.

**Sett:** 12 epi (50/10 cm)

**Width of warp:** 30" (76.2 cm)

**Length of warp:** 3 yards (2.7 m) (including shrinkage and waste)

**Threading, tie-up, and tread-ling:** Plain weave.

**Color order of the weft:** 3" white chenille; 1½" ombre using the color sequence of Fig. 1 going from the white band to the dark band; 3" dark chenille interspersed with metallic thread.

				1			2	3	4
dark									
beige	1	2	2	1	3	3	2	1	
white	3	2			1				

FIGURE 1. Color sequence from white band to dark band.

The metallic weft is used in the dark chenille band only. After weaving 4 picks of chenille, throw

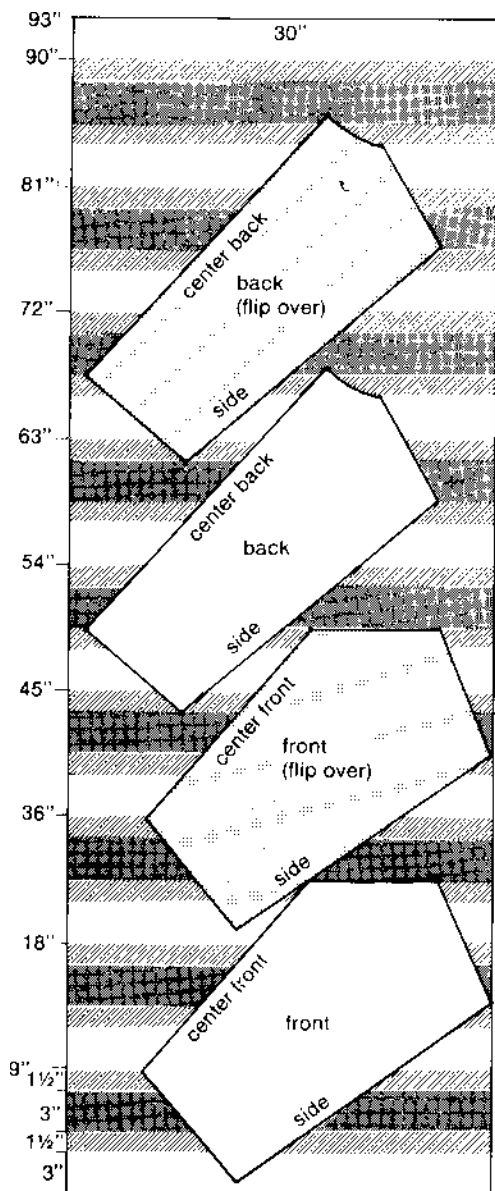

FIGURE 3. Layout with identical stripes on each pair of pieces. Note that one back and one front must be turned over after cutting.

the metallic thread from right to left but not across the entire warp. Change shed, return the metallic weft to the right. Weave another 4 picks of dark chenille. Weave again with metallic but turn the weft back at a different location in order to achieve a random look. To avoid build-up of the weft on the right hand side, occasionally throw an

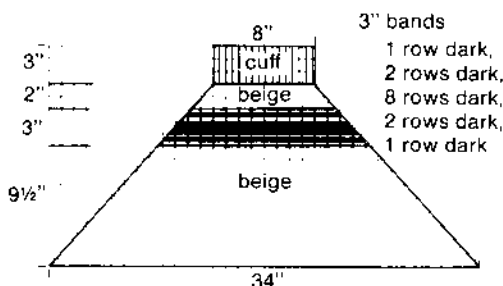

FIGURE 4. Knit sleeve

extra pick of chenille from the left hand side to compensate. See Fig. 2. Then weave 1 1/2" of ombre using the color sequence of Fig. 1 going from the dark band to the white band.

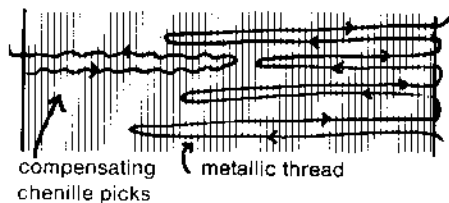

FIGURE 2

Repeat the white band, ombre band, dark band, ombre band, at least 9 times to weave a minimum of 2 1/4 yds of fabric.

**Finishing:** Wash the woven cloth before cutting the pattern. This is the type of garment for which a basic pattern made out of muslim is a must. Fig. 3 shows the approximate layout of the 4 main pattern pieces of the bodice. The cutting has to be very precise so that the stripes match up into perfect V patterns.

**Knitting the sleeves:** Stitch gauge: 4 stitches = 1 inch. The sleeves are knitted with double strands of chenille.

Start with white and cast on 34 stitches. Work in K 1, P 1 ribbing for 3". Change to beige and increase 12 stitches for a total of 46 stitches. Knit in stockinette stitch. From now on increase at the underarm seam only until the sleeve measures 34" at the shoulder. Add the bands according to Fig. 4.

**Sewing:** Finish the woven garment section and the knitted sections separately. Turn under the seam allowance of the woven bodies at the armhole. Insert the sleeves into the armholes and top-stitch as shown in Fig. 5.

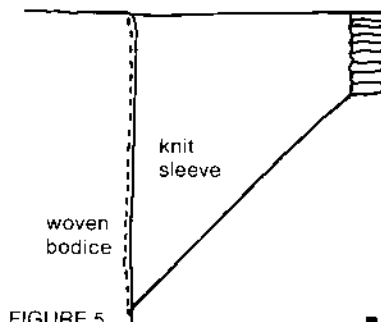

FIGURE 5



## Once Upon a Sheep

Founded by and for the spinner, weaver and knitter.

To bring exciting, affordable, yarns, wheels, and equipment, fleeces, fibers, dyes, books and classes.

Send for free brochure. Sample card \$2.00 refundable on first order.

P.O. BOX 613  
AMAWALK, N.Y. 10501

## "HERITAGE REVIVAL"

IN SWEDEN 1984.

In Rattvik, Dalarna:

- Homestead workshop
- Weaving workshop
- Folk dance and folk music workshop
- Folk costume workshop
- Genealogy workshop
- Swedish language workshop

July 28 to August 5, 1984

## SWEDES IN TOWN

Cultural exchange programs  
1709 Irvine Avenue  
Bemidji, MN 56601  
Phone: (218) 751-8707

Freight Free up to \$50

on looms from

- GLIMAKRA • NORWOOD •
- LECLERC • SCHACHT •
- BEKA •

also

PIPYCRAFT, LECLERC  
& ASHFORD  
SPINNING WHEELS

Complete book of  
catalogs available. \$5  
(deductible from first purchase  
of \$50.00 or more)

"INSTITUTIONAL INQUIRIES WELCOME"

## THE GOLDEN HEDDLE

1602 Rochester Rd.  
P.O. Box 761-WJ  
Royal Oak, MI 48068  
(313) 547-9159



white perle cotton, also from Weaver's Way, I used two threads of this as one end for the crinkled stripe.

In order to achieve the crinkled stripe, I needed to have this part of the warp under much less tension than the rest of the warp. This indicated that I needed two warps, the white one much longer than the colored one. I started with twice as much length for the longer warp. After my samples were completed, I scaled it down to something less than half as much extra length.

Following successful sampling, the loom was threaded for plain weave. The first warp, composed of the red, blue, and beige threads, was five yards (4.5 m) long.

The second warp consisted of the white threads for the crinkled stripes and was seven yards (6.3 m) long. The first warp was beamed; the second warp was left on top of the first; and both warps were threaded as one warp in the chosen color sequence.

First I tried beaming both warps on separate beams. This put too much tension on the second warp, and there were no crinkles. Then I took all the tension off this second warp, using only its own weight for tension. This worked very well for the samples, but for a warp with a width of 36 inches, it didn't work at all. I had loops and skipped threads in the fabric. After some experimenting, I used a one-ounce fish weight for every two white stripes. (See Fig. 1) I kept the first warp under as much tension as possible while the second warp was quite free. I was weaving seersucker!

**Warp:** 10/2 beige cotton, 16/2 blue and red cotton (using two threads as one end), 20/2 white perle cotton (using two threads as one end).

**Warp color sequence:**

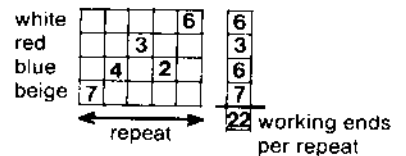

**Weft:** 20/2 white perle cotton



Blazer detail showing the crinkled white stripe.

## A SEERSUCKER BLAZER by Betty Johannesen

Seersucker: "Lightweight cotton blend with crinkled stripes woven in the warp direction by setting some of the warp yarns tight and others slack." This definition of seersucker appeared on page 72 of *The Vogue Sewing Book*, 1970.

I wanted very much to weave seersucker on my home loom. Crisp, fresh seersucker that I would make into a blazer for summerwear. I was sure that a blazer of 100% cotton could be hand-tailored in much the same way as good quality wool. I visualized the seersucker stripes in four colors, so the blazer could be

used with almost anything in my existing wardrobe.

My color plan for this 100% cotton seersucker combined red, beige, and blue stripes with a crinkled white stripe. I thought that a 10/2 cotton would make an ideal weight fabric. The 10/2 beige that I wanted to use was a mill-end from Weaver's Way, Crown Point, Indiana. The blue and red, I could find only in 16/2 from Scott Woolen Mill, Uxbridge, Massachusetts. I decided to use the 16/2, using two threads as one end for these two colors. Since I already had a 20/2

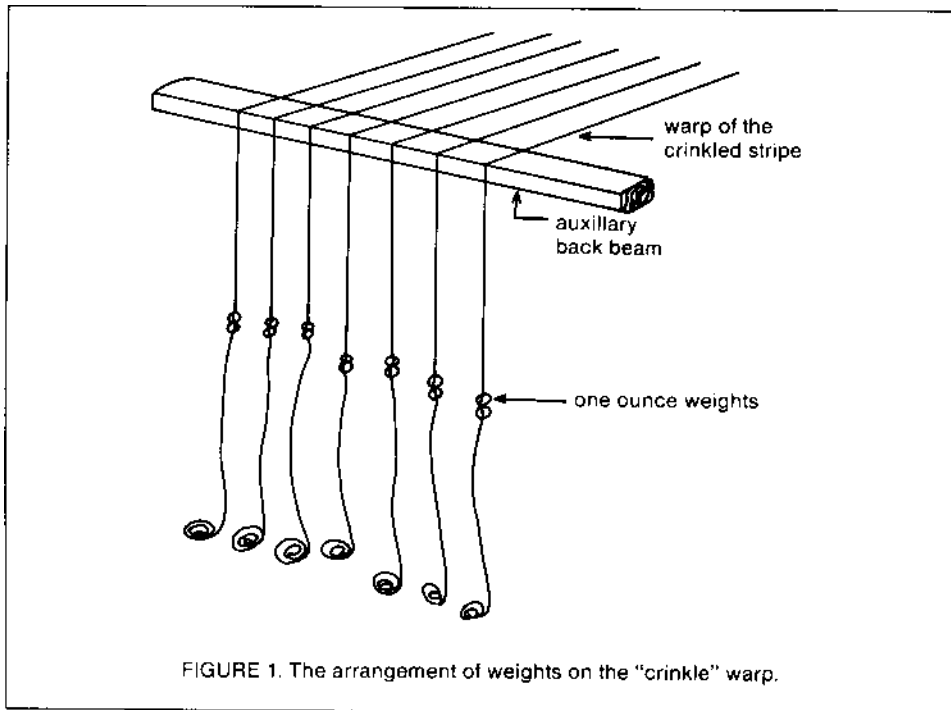

FIGURE 1. The arrangement of weights on the "crinkle" warp.

**Length of warp:** First warp, 5 yards (4.5 m). Second warp for crinkled white stripe, 7 yards (6.3m). The long yardage is needed because the uneven stripes make

the layout of the pattern pieces more difficult.

**Sett:** 24 epi (100/10 cm) using a 12 dent reed at two ends per dent

**Selvages:** use floating selvages

**Width in reed:** 36"

**Threading, tie-up, and treadling:** See Fig. 2.

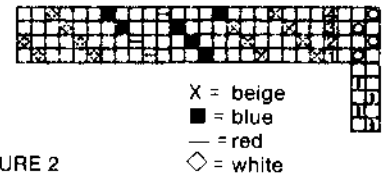

FIGURE 2

**Finished measurements:** 32" x 4 yards (81.3 cm x 3.6 m).

**Finishing:** I washed it in hot water with Ivory soap and under-dried it in the dryer. The shrinkage made very beautiful seersucker. By under-drying and permitting it to hang free for a day or two, no ironing was necessary.

*ABOUT THE AUTHOR: Betty Johannesen is a homemaker and part-time librarian in South Bend, Indiana. She has been weaving for seven years and is a member of the Niles Handweavers Guild. She enjoys participating in weaving workshops whenever it is possible.* ■



## Color is our business

A distinctive color line is no accident. Our color consultant, Nell Znamierowski, works with dyed-in-the-wool colors to develop our vibrant accents and subtle heathers. We think you'll like what they do for your projects.

We card and spin hand-weaving yarns from long-fibered 100% Virgin Wool. They are available in 4 weights in 52 colors and are sold at most fine handweaving shops.

Complete Sample Catalog:  
\$4.00

HARRISVILLE DESIGNS Harrisville, New Hampshire 03450



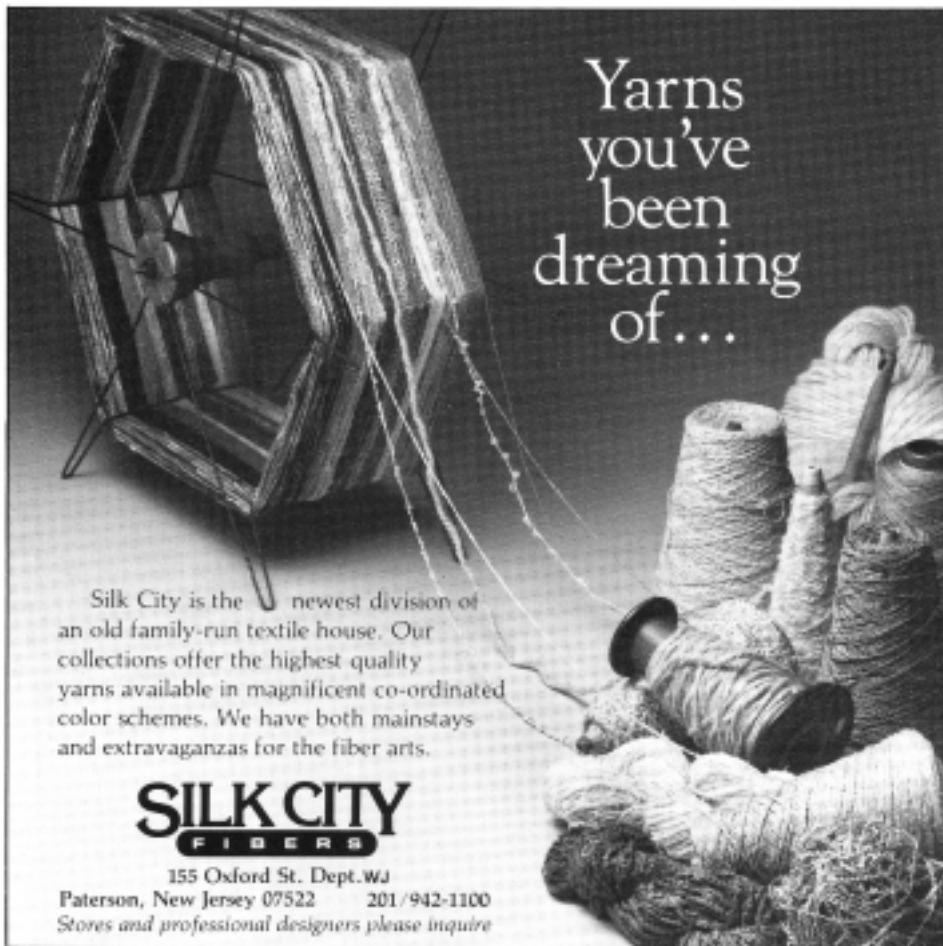

Yarns  
you've  
been  
dreaming  
of...

Silk City is the newest division of an old family-run textile house. Our collections offer the highest quality yarns available in magnificent co-ordinated color schemes. We have both mainstays and extravaganzas for the fiber arts.

**SILK CITY**  
FIBERS

155 Oxford St. Dept. WJ  
Paterson, New Jersey 07522 201/942-1100  
Stores and professional designers please inquire

## Tat an heirloom!

Complete tatting kit includes . . .



**3 Beautiful Wood Shuttles!**  
Our exclusive birdseye maple tatting shuttles are superbly hand-crafted. 3½", 4½" and 6" sizes.



**FREE BOOK!**  
Coats & Clark's "Learn to Tat" teaches tatting techniques plus 14 different lace patterns! It's yours FREE with kit!

Complete kit only

**\$15<sup>95</sup>** plus **\$1.89** shipping and handling

Total of payment: **\$17.84**. Offer expires 3/31/84. Send check or money order to:

**Serendipity Shop**  
1523 Ellinwood, Dept. W  
Des Plaines, IL 60016

Send 50¢ for our lace catalog.  
Send \$1 for our complete fibre arts catalog.

## The Guide to Successful Tapestry Weaving

by Nancy Harvey

A fully illustrated step-by-step guide for weavers of all skill levels who want to explore — and create for themselves — the intriguing world of tapestry.



Please send me \_\_\_\_\_ copy(ies) of *Tapestry Weaving* @ \$10.95 each plus \$1.00 postage and handling. In Wash. State add 6.7% sales tax.

Name \_\_\_\_\_

Address \_\_\_\_\_

City \_\_\_\_\_ State \_\_\_\_\_ Zip \_\_\_\_\_

**Pacific Search Press**  
222 Dexter Avenue North, Seattle, WA 98109

## *The Mannings*

### ANNUAL HANDWEAVING SHOW

APRIL 14 THRU MAY 6, 1984

Handweavers and fiberists from the United States and Canada are invited to participate in our 11th National Show. Every piece submitted will be hung. Limit one entry per person.

**PURPOSE:** To encourage quality and excellence in the art of weaving.

**CATEGORIES:** Traditional Weaving  
Handspun Hand Dyed Handwoven  
Handwoven Rugs  
Weaving You Can Wear  
Tapestry  
Weaving for Home Interiors  
Fiber Manipulation

**SCHEDULE:** Mailed and hand carried entries received March 19 thru March 31.  
Show dates — April 14 thru May 6.  
Mailed and hand carried entries returned May 7 thru May 11.

Brochures will be mailed out after January 1, 1984. Address your inquiry to:

**The Mannings**  
R. D. 2, EAST BERLIN, PA 17316  
(717) 624-2223



## PUBLICATIONS AVAILABLE from WEAVER'S JOURNAL PUBLICATIONS



1

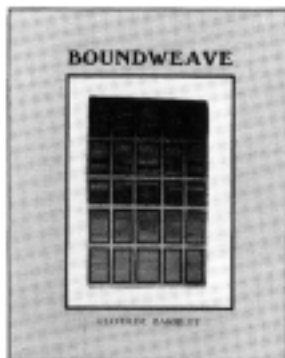

5



2

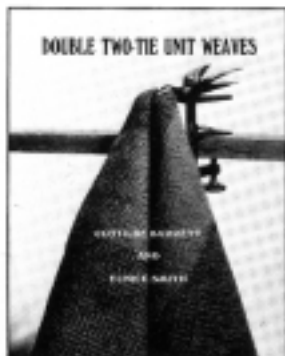

6



3

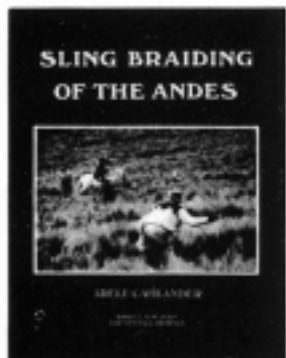
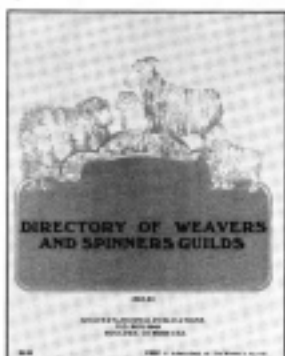

4

### 1. BOLIVIAN TUBULAR EDGING AND CROSS-WARP TECHNIQUES

by Adele Cahlander

In this monograph the author teaches readers how to do the tubular edge trim in plain weave and in a more intricate crossed-warp technique. The crossed-warp technique is used to make flat bands and round tubes that are very colorful and decorative and require no special equipment. The clear drawings of the positions of the hand teach the weaver how to produce the Bolivian weaves.

### 2. SUMMER AND WINTER AND BEYOND—2nd revised edition

by Clotilde Barrett

This monograph deals first with the classical ways of weaving this versatile fabric structure including multiple shaft block design and polychrome weaves. Unusual interpretations are explored, including pick-up, turned S/W, and rugs. It includes a four shaft four block version of S/W suitable for rugs and also S/W boundweave techniques using new ways to explore pattern and color on four shaft looms. It exposes readers to many new ideas.

### 3. SHADOW WEAVE AND CORKSCREW WEAVE

by Clotilde Barrett

The intricate designs produced by these weaves are the result of color effects applied to simple fabric structures. The patterns, based on twills, can be woven on looms with four shafts and up. The design principles are thoroughly explained so weavers can create their own original patterns. Corkscrew weave is included in this study because the threading draft of the weave is so closely related to shadow weave.

### 4. SLING BRAIDING OF THE ANDES

by Adele Cahlander with Elayne Zorn

Slings have been used since before the time of David and Goliath. Shepherds used slings to guide their sheep and to protect the sheep from marauding animals. In the Andes, slings took on ceremonial importance as well. This monograph is the first true documentation on the way the slings were constructed. Step-by-step instructions, with clear pattern diagrams and working sequences, make it possible now to reproduce a vast number and variety of these interesting braids.

### 5. BOUNDWEAVE

by Clotilde Barrett

This book explores the design potentials of twills, twill derivatives and some basic block weaves. Boundweave produces a weft faced fabric suitable for rugs and tapestries. It is a basic weave which can be explored on a 4-shaft loom. A multitude of patterns are possible by developing simple drafts and careful color selection of the weft. The principle of shaft switching is included. The text is beautifully illustrated with color, black/white photographs and line drawings.

### 6. DOUBLE TWO-TIE UNIT WEAVES

by Clotilde Barrett and Eunice Smith

Double two-tie unit threading drafts give the 8-shaft weaver the best opportunity to experiment with a vast number of exciting weave structures without rethreading the loom. There are hundreds of variations of this threading system that can be woven. This book will help you to discover them all. The design theory is explained in a clear and comprehensive way. Each step is illustrated with complete drafts and samples. There are close to 100 photos of weave structures and projects, in color and black/white.

### 7. DIRECTORY OF WEAVERS AND SPINNERS GUILDS

An updated listing of guilds in the United States and in foreign countries. In the U.S. section the guilds are listed alphabetically within each state. Federations and organization of interest to weavers are also included.

SEVERAL PUBLICATIONS  
OF INTEREST TO THE  
HANDWEAVER ARE IN  
THE PLANNING STAGE.

### ORDER FORM



Name \_\_\_\_\_

Address \_\_\_\_\_

- 1. BOLIVIAN TUBULAR EDGING AND CROSS-WARP TECHNIQUES @ \$ 3.00 \_\_\_\_\_
- 2. SUMMER AND WINTER AND BEYOND @ \$5.00 \_\_\_\_\_
- 3. SHADOW WEAVE AND CORKSCREW WEAVE @ \$5.00 \_\_\_\_\_
- 4. SLING BRAIDING OF THE ANDES @ \$10.00 \_\_\_\_\_
- 5. BOUNDWEAVE @ \$9.95 \_\_\_\_\_
- 6. DOUBLE TWO-TIE UNIT WEAVES @ \$12.00 \_\_\_\_\_
- 7. DIRECTORY OF WEAVERS AND SPINNERS GUILDS @ \$2.00 \_\_\_\_\_

Add postage/handling \_\_\_\_\_

Amount enclosed \_\_\_\_\_

Pay in U.S. currency, payable to The Weaver's Journal Publications, P.O. Box 2049, Boulder, CO 80306.  
Colorado residents, add 3 1/2% tax.

For postage/handling, add \$1.00 for each book under \$6.00. Add \$1.50 for each book over \$6.00.

# fashion trends

by Susan Hick

The subject is wrapping up Winter as Spring looms on the fashion horizon.

For many of us the coldest is still to come. Shawls and scarves will ward off the chill while adding fresh life to tiring wardrobes. Rectangles or squares, all sizes are good. The trend in yarns is toward the finer, but as always the textured ones are appreciated. As the icy weather and supplies of wool on hand dwindle, looser setts and space denting and lacy weaves can be used. And the transition to Spring has been made.

Everything about the new season says Sportier, with a variety of fashionable happenings to translate into the handweaver's language.

The character of the fabrics most used is best described as rustic and rich with roughed-up, yet subtle, surface textures. This is accomplished in a carefully controlled manner, and the look is very definitely handwoven.

Diverse influences make a play for prominence. Called the Primitives, the native looks of cloth from Africa, South America and the South Sea islands are important. An African motif might combine beige, teal, maroon and black; a cave drawing print might have earthtones of taupe, orange and ochre on cream. Other colors of this genre are turquoise, rust, purple, hot pink, medium blue, light green, yellow and white. Ikat and tie-dye techniques, especially the Japanese *kasuri* and *shibori*, are outstanding and not always the dark colors and distressed looks of workwear. Abstract expressionist paintings cue other fabrics, notably spatter-and-drip in primary pigments.



... roughed-up surface textures ... p. 18



... segue into Spring with a shawl ... p. 82



... everything says Sportier ... p. 69



... stripe is the most prominent pattern ... p. 42

Rich textures command attention. Nubby or slubbed yarns, of course, are one source. Thick-and-thin yarns are seen the most. Ribbons might be used. With smoother yarns the weave structure is the source of textures. Wrinkles become the crinkles of seersucker. Wide bands of the puckers are the most original. Basketweave and tiny waffles and woven meshes—open and lacy and bordering on net—are to be considered.

Visual interests, too, are not to be ignored. The stripe is the most prominent pattern of the season, generally derived from color but also appealing with textured yarns or mixed weaves. End-and-end constructions for either stripes or pin dots are very popular. Space-dyed yarns form clever checks and plaids. Subtle color differences add a dimension to shadow plaids. Plaids range from diminutive to big time, including an overplaid which adds a large-scale crossbar to a smaller plaid.

Stripes as coordinating fabrics are most intriguing to contemplate. A bicolor basketweave might be paired with herringbone stripes or a wide irregular stripe with one that is narrow and regular. Color changes are another possibility: tints of a color in one fabric against tones of the color in the other; the same stripe color arrangement on differently colored backgrounds.

All these fabrics are executed in the familiar warm-weather fibers. Linen is as big as ever, while silk sees more and more attention. Add cotton and rayon and blend or intermix in various amounts; the potential seems endless.



... wrinkles become crinkles ... p. 22



... relaxed, yet clean-cut ... p. 12



... easy-over toppers ... p. 14



... rich textures ... p. 10



... beiges range from eggshell to taupe ... p. 20



... diverse influences ... p. 46

It's back to the Desert for color inspiration. Here are the hues from several seasons ago that have spent some time since then in the sun and thus become bleached. Picture white-washed tints of violet, magenta, ochre, terra cotta, apricot, turquoise, and indigo, and they are all combined with more white. To lighten up a yarn, try a white weft on a colored warp.

The grayed pastels are no longer around, but gray certainly is, from pearly oyster to slate. It looks fresh with cream, pink, or mauve. The beiges range from an off-white eggshell through sand to taupe. A

new neutral has a strong hint of khaki while another is softly orange. (As an aside, it's interesting to note that purple is on the way to being considered a neutral.) All of these become wonderfully crisp alongside white.

Bubblegum pink is a strong bright to add to the spectrum, along with the nautical red, blue, and yellow. Yellow is the new accent color, as in taupe and yellow or khaki and white and yellow. Finally, dark tones (teal, rust, cranberry, violet) can be used alone or with the neutrals or, predictably, white.

Another plus for the handweaver are the current styles, relaxed yet clean-cut and simple. The illusion of slimness is there, but plenty of room is built in.

Bold shoulders highlight the chemise, perfect for those of us who haven't perfect shapes, and the bigger jacket, lengthened to the finger tips. Big shirts with drop shoulders can double as jackets. Little jackets are cropped at or above the waist, calling attention to details there. The dolman sleeve is still important, and sleeves may still be puffed or pleated at the shoulders.

Shapes reminiscent of kimonos and the easy-over toppers that weavers do so well are again abundant. Bateau necks seem to slip off a shoulder, the "Flashdance" connection. Pants remain an essential, often rolled up the calf. Jumpsuits with minimal details are roomy and comfortable. Walking shorts and sassy little pant-skirts are seen. Layered looks are played down and light weight; a cropped vest or sleeveless jacket might be pulled over a T-blouse and a mid-calf skirt.

The mesh fabrics cited earlier are used for sleeves, as side panels, or layered over Tees and tanks. The more daring might make these open weaves into a skirt or billowy pants. Horizontal stripes could be used just for the front and back panels of a dress or top. Other embellishments to add spice: a tracery of embroidery; bands of short sewn-down fringe at edges or seamlines; strips joined with fagoting; substantial pockets; trapunto detailing, especially at the waist; shirring; diagonal seaming; a middy collar on a jacket.

The spectacle of fashion moves in the future. Pick fiber, weave, and color and design your statement. And while you're contemplating, segue into Spring with a shawl or a scarf.

# ADVENTURES OF A COMPUTER CONVERT (Computer Programming by a Novice) by Doramay Keasbey

How do you feel about computers applied to weaving? If you have the opportunity to try one, you may be pleasantly surprised! Not so very long ago I associated computers mainly with large businesses or for use in industrial and scientific processes. Suddenly, it seems, computers are in evidence everywhere from banks and grocery stores to private homes—including those of weavers! When one of these wondrous machines came to reside in our home, I welcomed it as a way to become acquainted with a new tool. I was surprised to find that getting acquainted with a computer was easier than I had expected. I also discovered that they are not all alike, and so the program demonstrated on a friend's machine may not necessarily work on mine. However, I soon learned how to achieve meaningful results independently and can happily report that much can be accomplished even with very little experience.

A computer's ability to perform repetitive jobs and make calculations very rapidly make it handy for storing records, keeping inventories, and aiding correspondence, to name just a few examples of uses a weaver might choose. However, for visually oriented craftsmen, the most fascinating use may be its application to design. So it was on this aspect that I concentrated my first efforts. As a long-time weaver but a very new computer user, I would like to share some successful experiments in this area.

This article is for anyone just beginning to explore the wide world of computers as they relate to weaving. In any craft, the best way to appreciate the possibilities of a tool is to use it. Using a computer for the first time is an adventure. It seems especially challenging when

there is no one nearby to offer guidance or when clear instructions are not available. That was my situation, so progress seemed slow at first, but eventual success rewarded persistence. I hope that the resulting program shared here will encourage others who may be struggling with frustrating obstacles similar to those I encountered.

One does not need to be experienced in computer science to use a ready-made computer program. There are already many on the market and more being advertised all the time in weavers' periodicals. Selecting one to fit one's needs and equipment would be the easiest way to start. I imagine that if I had found a perfect match for program and equipment I would have used them happily and not bothered to search for alternatives.

What does one do, however, when there seems to be no ready-made program available to use with a particular brand of computer? One answer could be, "Forget about it. It really isn't necessary anyway since I can visualize patterns mentally or work them out on paper by hand." Another could be, "Wait—someone may develop just the right program and make it available eventually." A third answer which could lead to tailor-made usefulness and greatest independence in the long run is, "Make up your own program to fit your own interests and equipment." This last response suited my situation and temperament and was the start to adventures in a totally new direction. I see now that another advantage to this last approach is the ability to make minor alterations in programs in order to fit individual needs. In the same way that understanding tie-ups and threading drafts helps a weaver to adjust

weaving patterns to fit the limitations of a specific loom, even slight knowledge of computer programming may be enough to adjust a given program to the requirements of one's specific equipment.

Until very recently I knew nothing about computers, programs or even the vocabulary needed to discuss them. Although still very close to the beginning, I find that a little practice has given me confidence to proceed and to share experiences which I hope will be helpful to others. When our family began to consider acquiring a micro-computer to serve as a word processor for my husband's language translation business, my interest sharpened. Until then I could admit only mild curiosity. It was about that time that I observed a friend's demonstration of a weaving simulation program. It did look like fun. So I decided it would be worth investigating when I finally had access to a computer of our own, but for a while I would have to wait.

While waiting I found my attitude strangely ambivalent. The potential power of a computer is impressive. But while recognizing its capacity to turn out drawdowns easily and rapidly, I resisted acknowledging that it could be superior to my trusty pencil and paper. I also felt that I could imagine yarn color and texture as well as interlacement of warp and weft more realistically than a computer could represent them. It is clear that the machine can only follow orders—those given to it by the program and those provided by the person operating it. A well planned and comprehensive program should, therefore, enable a weaver to design more efficiently by making the most of the computer's capacity for speed and neat uniformity. Why not reduce the drudgery of tedious plotting by hand? I felt, however, that some advantages of the paper and pencil method were flexibility for consciously adapting a design for specific purposes or to fit the limitations of a specific loom. Then I recognized that these considerations could be built into a computer

program. Therefore, I decided that I should learn to write my own programs which could incorporate my choices. Another thought in favor of the computer is that its output in tangible form can be shared with others, whereas it is often difficult to describe a purely mental image of a planned design to a friend or client.

A beginner's course in computer science would have been helpful at this stage, but an already full schedule of commitments interfered, and I settled for sporadic reading of a college textbook entitled *BASIC for Students: with Applications* by Michael Trombetta. I recommend this book highly. Unlike many books on BASIC, this one is not written for a specific brand of computer. It teaches the rudiments of programming in logical steps of increasing complexity and carefully points out variable features used in different versions of BASIC so that the student can note the appropriate version for his own equipment.

A computer program is like a very detailed itinerary which indicates to the traveler the exact route to follow including specific errands to do along the way and guidance for deciding which direction to go whenever the road branches. The art of programming reminds me of the process of planning and placing clues for a treasure hunt. Some clues are direct—for example, "Go to (a certain place)". Others may require deciphering first, involving the examination of bits of information carefully arranged along the path. If the clues are understandable and placed in logical order, the treasure seeker should succeed in reaching the desired goal and be rewarded with the treasure. The routes mapped out by the program accompanying this article lead to neat, precise drawdowns which are indeed a fitting treasure for a weaver.

Programming involves communicating with the computer in a "language" it can understand. I suppose the most direct communica-

tion would be through machine or assembly language. But as a weaver just getting acquainted with computers, I chose to learn a language closer to my own. The program given in this article is written in BASIC, popular because it is easy to learn and can be used with most microcomputers. Slight differences in dialect acceptable by various computer brands may require minor adaptations. The version in this program is called Microsoft BASIC. The book I found most helpful as a reference for this specific version is *Microsoft BASIC* by Ken Knecht.

Besides the brand of computer and specific version of the language to use, one needs to be aware of the kind of printer attached to it in case printing on paper is planned. Each type of printer has its own capabilities and limitations.

The printer we selected is excellent for text, but not ideal for graphic representation since our computer was chosen primarily for use as a word processor. Information is typed into it by means of a keyboard. Text is displayed on the black-and-white (actually black-and-green) television-like screen, edited as desired, and when ready in final form, printed automatically onto a roll of paper which passes through a typewriter-like machine equipped with carbon ribbon and daisy wheel printing element. This produces sharp, letter-quality text. Limited graphic effects may be obtained on the video screen through the use of special characters, but these cannot be reproduced by our particular printer since it is limited to the letters of the alphabet plus a few other symbols like a normal typewriter. Because it prints as a typewriter, it does not produce a squared image but rather 10 characters per inch measured horizontally and 6 lines per inch measured vertically. As can be seen by the accompanying illustrations, this spacing is not ideal for a weaver's drawdown, but it may be considered adequate. The display on the screen has slightly better proportions, that is, closer to

square—about 6 characters horizontally by 4 lines vertically for each inch. If only display on the screen is desired, it is wise to consider its capacity in terms of maximum number of characters visible vertically and horizontally. Although it may be possible to "scroll" the display from side to side or up and down, it is easier to grasp the full effect of a design when it fits within the borders of the screen. For this reason my program attempts to limit each pattern development to a roughly average size.

### SNOWFLAKES

```

X XX   X X X   XX X   C
  X X           X X   B
X XX   X X X   XX X   C
X XX   X X X   XX X   C
  X X           X X   B
           X       X   D
           X X X X   A
X XX   X X X   XX X   C
           X X X X   A
X XX   X X X   XX X   C
           X X X X   A
           X       X   D
  X X           X X   B
X XX   X X X   XX X   C
X XX   X X X   XX X   C
  X X           X X   B
X XX   X X X   XX X   C

```

### CBCCBDACACACADBCCBC

Daisy wheel printer prints as a typewriter

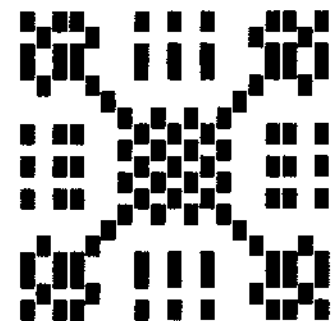

Display as seen on monitor screen

```

10 PRINT "PROFILE DEVELOPMENT - UP TO 4 BLOCKS": PRINT
20 REM EARL BARRETT'S SHORT SWEET PROGRAM
25 REM THE WEAVERS JOURNAL, WINTER 81-82, P. 43
30 REM MODIFIED BY DORAMAY KEASBEY
40 REM ADDING CODES FOR NAME DRAFTS
50 PRINT "ENTER ANY WORD OR SHORT PHRASE"
60 PRINT " (EACH LETTER = ONE BLOCK UNIT)"
70 PRINT " PRESS RETURN KEY WHEN FINISHED": PRINT
80 INPUT NS: PRINT
90 LET AS = "ABCDEFGHIJKLMNOPQRSTUVWXYZ"
100 PRINT "CHOOSE CODE TO TRANSLATE NAME TO BLOCKS": PRINT
110 PRINT " (1 OR 2 OR 3) (4 = ORIGINAL CODE)"
120 INPUT QS: PRINT
130 IF QS = "1" THEN GOSUB 480
140 IF QS = "2" THEN GOSUB 500
150 IF QS = "3" THEN GOSUB 520
160 IF QS = "4" THEN GOSUB 540
170 GOSUB 590
180 PRINT
190 PRINT "REVERSE FOR SYMMETRY? (Y OR N)"
200 INPUT QS: IF QS = "Y" THEN GOSUB 400
210 PRINT
220 PRINT "REPEAT? (Y OR N)"
230 INPUT QS: IF QS = "N" THEN GOTO 250
240 TS = TS + TS
250 PRINT "PROFILE DEVELOPMENT"
260 PRINT "AS DRAWN IN' - ONE BLOCK PER ROW": PRINT
270 HS = TS: PRINT
280 PRINT "PROFILE DEVELOPMENT": PRINT
290 PRINT TS: PRINT
300 FOR I = 1 TO LEN (HS)
310 FOR J = 1 TO LEN(TS)
320 BS=MID$(TS,J):CS=MID$(HS,I)
330 IF ASC(BS) = ASC(CS) THEN PRINT CHR$(150);
340 IF ASC (BS) <> ASC(CS) THEN PRINT CHR$(32);
350 NEXT J
360 PRINT CHR$(0); " "; MID$(HS,I,1)
370 NEXT I
380 PRINT: PRINT TS
390 END
400 REM REVERSE ORDER FOR BLOCKS (TS)
410 L = LEN (TS)
420 FOR X = L TO 1 STEP -1
430 BS = MID$(TS,X,1)
440 CS = CS + BS
450 NEXT X
460 TS = TS + MID$(CS,2)
470 RETURN
480 LET BS = "ABCDABCDABCDABCDABCDABCDAB": REM CODE 1
490 RETURN
500 LET BS = "AAAABBBBCCCCDDDDAAAABBBBCC": REM CODE 2
510 RETURN
520 LET BS = "AAAAAABBBBBBCCCCCCCCDDDDDDAA"
530 RETURN
540 PRINT "TYPE BLOCK CODE BENEATH ALPHABET"
550 PRINT
560 PRINT " ABCDEFGHIJKLMNOPQRSTUVWXYZ"
570 INPUT BS
580 RETURN
590 LET TS = ""
600 LET L = LEN (NS)
610 REM ENCODE ONE LETTER AT A TIME
620 FOR I = 1 TO L
630 LET LS = MID$(NS,I,1)
640 GOSUB 710
650 IF J = 0 THEN 680
660 LET TS = TS + MID$(BS,J,1)
670 GOTO 700
680 REM CURRENT CHARACTER NOT IN AS, ADD IT TO TS UNCHANGED
690 LET TS = TS + MID$(NS,I,1)
700 NEXT I
710 FOR J = 1 TO 26
720 IF LS = MID$(AS,J,1) THEN 750
730 NEXT J
740 LET J = 0
750 RETURN

```

The program given here develops block patterns from a profile. The profile in this program is determined from the arrangement of letters in a word, name, or phrase according to the code chosen, in this case, the word "ALPHABET" using code 2. Four optional codes are given, three of them prearranged, and the fourth available for original designing. Each cre-

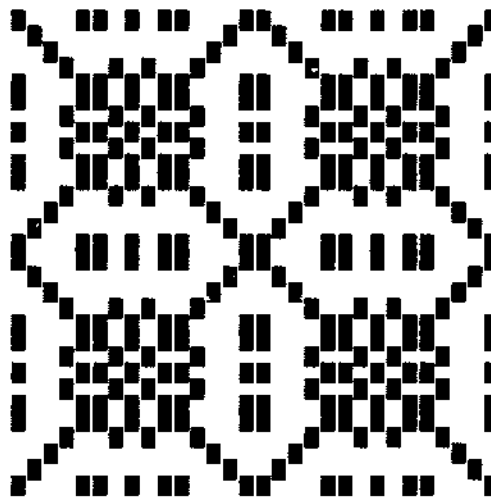

ACDBAABABAABDCAACDBAABABAABDCA

ACDBAABABAABDCAACDBAABABAABDCA

```

X  XX X XX  XX  XX X XX  X A
X  X X X X  X  X X X X  X C
X  X X X X  X  X X X X  X D
X  XX X XX  XX  XX X XX  X B
X  XX X XX  XX  XX X XX  X A
X  X X X X  X  X X X X  X B
X  XX X XX  XX  XX X XX  X A
X  XX X XX  XX  XX X XX  X A
X  X X X X  X  X X X X  X B
X  X X X X  X  X X X X  X C
X  XX X XX  XX  XX X XX  X A
X  XX X XX  XX  XX X XX  X A
X  X X X X  X  X X X X  X B
X  X X X X  X  X X X X  X D
X  X X X X  X  X X X X  X C
X  XX X XX  XX  XX X XX  X A

```

Profile development of the word "ALPHABET" using code #2

ates a distinctly different pattern. The basic program was printed in *The Weaver's Journal* for Winter 1981-82 as noted. The changes and additions shown here allow the resulting pattern development to be displayed on the screen using solid figures for the block units. If X's are desired, change program line 330 from CHR\$(150) to CHR\$(88);". Blocks are labeled A, B, C, or D in both threading and treadling directions. Suitable weaves for block patterns include Summer and Winter, Atwater-Bronson lace, twill blocks, double weave, and many others. To interpret any of these patterns on the loom, thread each block according to the key threading unit for the chosen weave, and treadle according to the typical shed sequence for that weave, guided by the lettered blocks.

Many more variations are possible. I hope that these few illustrations will inspire others to explore further, to share exciting discoveries,

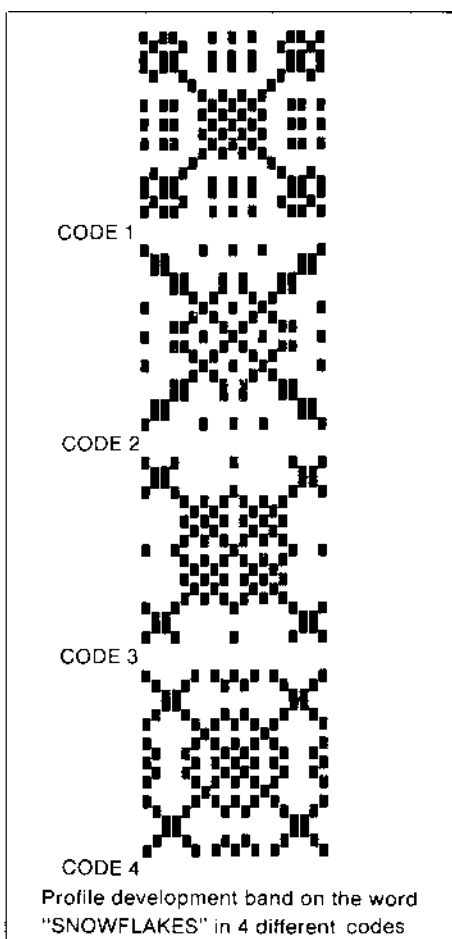

and most of all to enjoy the freedom that comes with practicing a new skill.

#### Bibliography

- Barrett, Earl. "A Short and Sweet Draw-down Program for Computers", *The Weaver's Journal* (23) Winter 1981-82, pp. 42-43.
- Knecht, Ken. *Microsoft BASIC*. Dilithium Press, Beaverton, Oregon. (Second Edition) 1983.
- Trombetta, Michael. *BASIC for Students with Applications*. Addison-Wesley Publishing Co., Reading, Massachusetts, (Reprinted with corrections) 1982.

**ABOUT THE AUTHOR:** *Doramay Keashey, an active weaver since 1962, specializes in handwoven fashion fabrics and custom-designed wall hangings. Her work is shown regularly at the Torpedo Factory Art Center in Alexandria, Virginia, and is exhibited frequently in the metropolitan Washington, DC, area and elsewhere in the eastern states. Doramay holds a Master of Fine Arts degree from Antioch University, Master Weaver rating from her local guild, and a Certificate of Excellence in Handweaving from the Handweavers Guild of America. Her experiments and research into unusual techniques and equipment are shared readily with other weavers through lectures, workshops, and her published works. Doramay is the author of numerous technical articles appearing in major weaving periodicals and of the book Pattern Devices for Handweavers.*

## Handweaving with Robert and Roberta

is a winner and a best buy for its comprehensive educational value

### HOME STUDY COURSE

16 books

Only \$107.00 or \$26.95 for the first 4 books including yarn samples and prices for all weaving projects with each book.

This highly rated and clearly written home study program covers

- BUSINESS • COLOR • DESIGNING • DRAFTING •
- EQUIPMENT • FIBERS (with samples) •
- BEAUTIFUL WEAVING PROJECTS •

Planned to help you STEP by STEP to progress far beyond the many weavers who have floundered year after year.

*Start now or write for more details.*

**AYOTTE'S DESIGNERY**

P.O. Box 287 WJ  
Center Sandwich, NH 03227

## ANOTHER CHOICE

### For Perle Cottons in Color

Weaver's Way is commissioning custom dye lots of its perle 10 and 5 cottons. The same best quality cottons that you've used in natural and white are now available in vat dye colors on one-pound and 8-ounce cones.

**Order Toll Free: 800-348-3483**



Indiana - 219-663-1406

**Weaver's Way**

306 E. Goldsboro St., Crown Point, IN 46307

Please send \$1.00 for catalog and complete set of sample cards.

# COMPUTER CONTROL OF TIE-UPS AND TREADLING SEQUENCE

by Richard Clement

This is not intended as a specific how-to-build article but rather as a general description of how computer control of tie-ups and treadling is accomplished.

A number of computer controlled looms are available for the home weaver, two of them being regularly advertised in *The Weaver's Journal*. I suspect that many weavers reading these ads must be interested in knowing how these looms work, albeit with varying degrees of interest. It is to these weavers that this article is directed.

About three years ago I began to build an 8-shaft loom with a mechanical dobby mechanism—the kind with a series of parallel sticks with pegs in them, rotating around a drum (see Fig. 1). For an 8-shaft loom, each stick has holes for 8 pegs. The tie-ups are determined by which holes are pegged and which are left empty. As the strip with its pegs is rotated into position, the pegs bear against the shaft lift cords pushing them in-

ward. As the fork is pulled down by the action of the single treadle, it contacts those lift cords which haven't been pushed out of its way by the dobby pegs, and lifts those shafts.

By the end of the first year, the loom had been built and the dobby mechanism was well along. Sometime within this period I had obtained a small computer, the Sinclair ZX-80, and had gotten quite interested in its capabilities. This led me to decide to substitute an electronic device for the mechanical device I'd been building. Suffice it to say that about a year ago I'd completed my computer-controlled 8-shaft loom and have woven several projects on it with no problems. In the meantime my computer has been upgraded to a TRS80 Mod III with disk storage. (Photo 1) Now for the how-it-works story.

Computer memory cells have only two states, i.e. on or off. In this they are similar to an electric light switch—on or off. The *on* state can

be represented by the number one and the *off* state by a zero. Eight of these *on* or *off* memory cells can be converted by the computer to a decimal number from 0 to 255. Thus we see that a decimal number between 0 and 255 represents a specific combination of ones and zeroes (on's and off's). These in turn can be equated with the o's and blanks that we use to indicate our shaft tie-ups (see Fig. 2). Note that the tie-up is shown as a decimal number. Treadling is determined by the sequence of these decimal numbers.

Fig. 3 shows the essentials of the computer program. The DATA put into the computer memory consists of the decimal numbers of the tie-ups and are listed in the desired treadling sequence. The OUT command tells the computer to output the first data number (remember that what the computer sends out are eight *on* or *off* voltage signals—usually +5 or 0 volts). For the moment don't worry about where these signals go—we'll get to

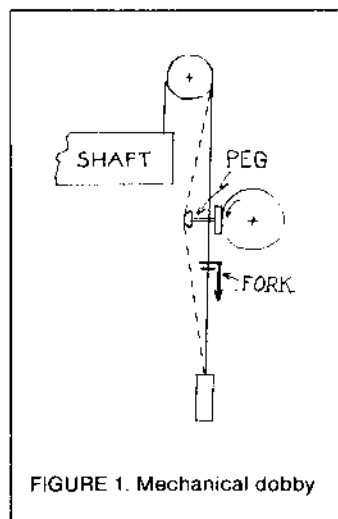

FIGURE 1. Mechanical dobby

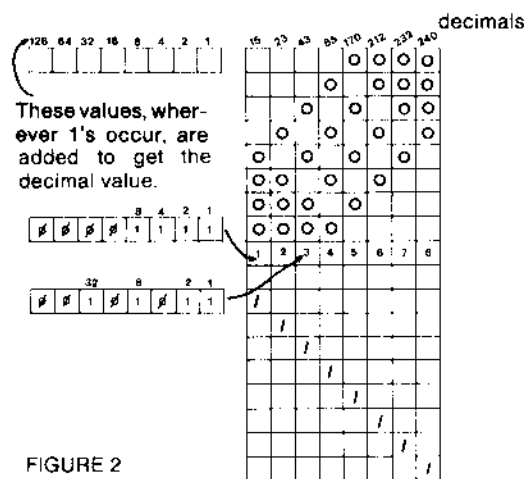

FIGURE 2

## ESSENTIAL PARTS OF COMPUTER PROGRAM

DATA 15,23,43,85,170,212,232,240  
 OUT DATA  
 IN NEXT DATA  
 REPEAT AFTER LAST DATA

FIGURE 3





1. Computer and PIO (peripheral input-output) chips.



2. Operating mechanism for computer controlled 8 shaft loom.

that. As the first pick is completed a switch closes on the loom and sends an IN signal back to the computer. This tells the computer to get the next DATA number and to send it OUT. After all of the DATA numbers are used, REPEAT tells the computer to start all over again at the beginning. Of course the actual program has a few more lines, but this is the essence of the program.

Now to get back to what happens to the OUT signals (See Fig. 4). The program had been stored on a magnetic disc. It is called into the computer memory and when we run the program the OUT signal is initiated. The eight voltage signals

(+5 or 0 volts) are carried by a multi-conductor ribbon cable to a PIO chip (peripheral input/output) (see Fig. 5). There they are latched into a continuous state and buffered to enable them to provide adequate current for relay operation. Each signal goes to its own relay and causes the relay contacts to open or close. The use of a relay permits the relatively high load current solenoids to be operated by low current computer signals. A solenoid is a magnetic coil enclosing a plunger and causing the plunger to pull into the coil when the coil is energized. Referring again to Fig. 4, we see a schematic representation of the operation of one of the eight solenoids and shafts. The loom is a

common type with the shafts lifted by cords which run over top pulleys. In this case the cords are kept vertical by weights at the bottom. Each cord has a washer fastened on it near its midpoint. A fork (with fingers reaching over the washer) tied to the single treadle, will pull the cord down (and the shaft) up. If, however, the solenoid pulls the cord out away from the loom, the fork no longer reaches the washer on the cord and the shaft associated with that solenoid remains stationary when the fork is treadled. You will note that the operation is similar to that of the mechanical dobby described earlier, but in this case the shaft lift cord is pulled out rather than pushed in (see Photos 3 and 4).

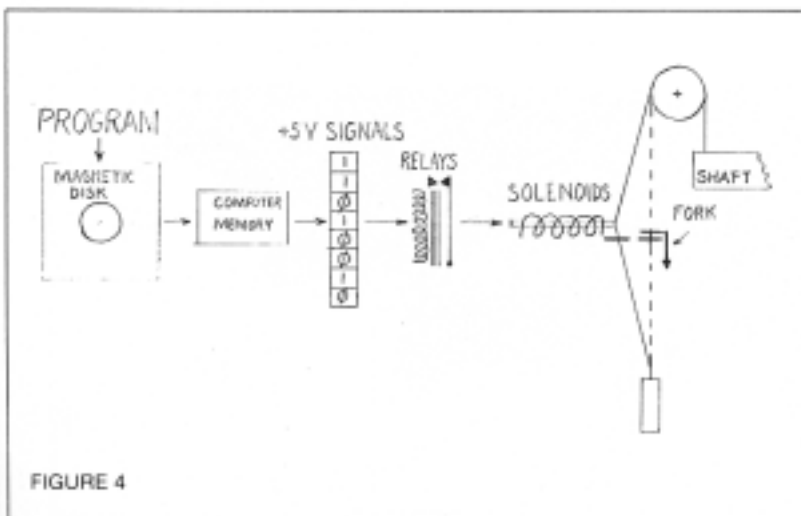

FIGURE 4

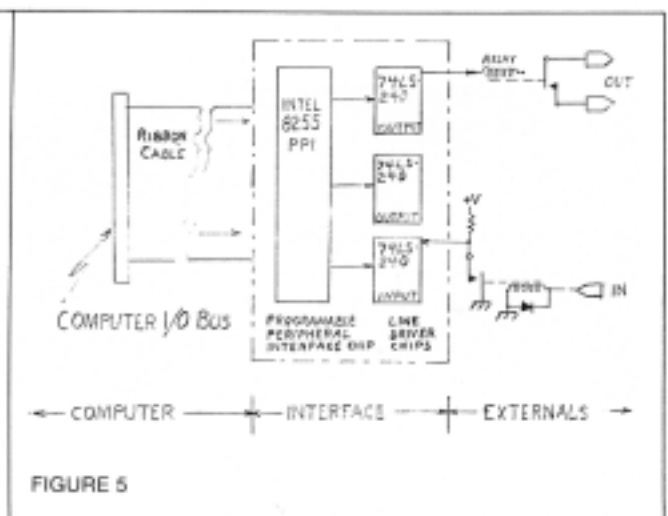
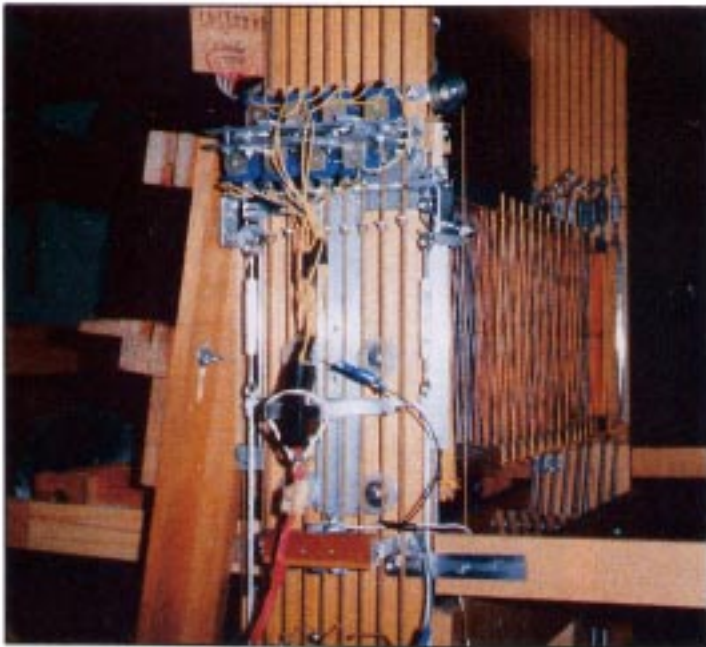
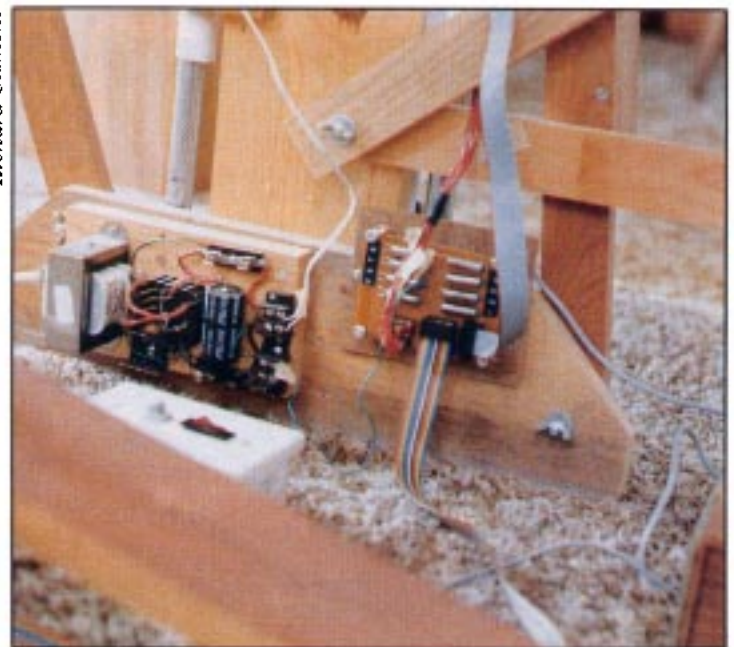

FIGURE 5



3. Detail of solenoids and fork. The fork pulls against the knots and washers visible on the shaft cords about an inch below the fork.



4. Power supply and reed relay panel.

Another very common type of loom has the shafts lifted by rocker arms. These rocker arms may be located either above the shafts or below them (see Fig. 6).

Hanging from each lam is a "pull-rod" (I used straightened coat hangers). This rod terminates with its lower end bent in under the single treadle. Each rod has its own solenoid with a spring return. Those solenoids that are activated hold the rods clear of the treadle. Those solenoids receiving a zero signal let the rods remain hooked under the treadle ensuring the lift of its shaft when treadled. This design is far simpler to implement than that used with the cord and pulley looms. Existing looms with rocker arms can be modified for

computer control with very few changes.

Weaving with a computer controlled loom consists of depressing the single treadle, throwing the shuttle across, treadling again and

throwing the shuttle back again. Niceties can be added such as 8 lights to show the shaft status, the listing of weft colors as they're called for, and an indication of the completion of a pattern sequence.

While many weavers will not feel the need or desire to buy or build a computerized loom, I hope that this brief description will satisfy some of the curiosity about their operation.

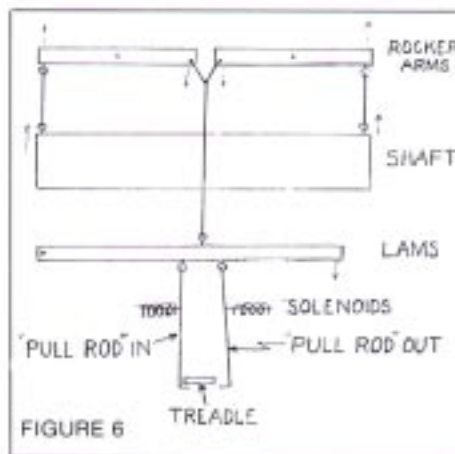

**ABOUT THE AUTHOR:** Richard W. Clement is an engineer with a master's degree from Harvard. In 1977 he retired from The Consolidated Edison Co. of New York as Assistant Vice President of Engineering. His work was largely the design and operation of electric generating plants, both conventional and nuclear. He now lives with his wife in Deming, N. M. They weave on the two looms they have built themselves. Richard Clement is active in the Southern New Mexico Weavers Guild. ■

announcing

a new mill in New Mexico • to serve handspinners, knitters, weavers and fiber artists.

CUSTOM CARDED BLENDS

NATURAL YARNS

• CUSTOM WOOLEN SPINNING •

RIO GRANDE WOOL MILL, Inc. BOX 8a, TRES PIEDRAS, NM 87577

# THE IRISH KINSALE CLOAK

by Una Jones

*"For cloaks they have five or six yards of frize drawn round the neck, the body and over the head and they never quit this mantle either in sleeping, working or eating."*

*Le Gouz  
A Tour in Ireland, 1644*

I cannot say exactly what intrigued me about the fabrication of a cloak; perhaps the romantic appeal they have always enjoyed in movies and literature. I recall their inclusion in such personal favorites as *The Scarlet Letter*, horror classics such as *Count Dracula*, and, more recently, *The French Lieutenant's Woman*. The cloak has, in the past as well as the present, employed a vast array of roles, being used as a prop by artists and authors to attribute the qualities necessary for believable characterizations.

A personal interest in the Irish Kinsale Cloak or Mantle, probably stems from my maternal British heritage and an early fascination with fashion or the adornment of the body. As a child, I watched in awe as the seemingly endless yards of glittering fabric were formed into capes by my mother, a maker of circus costumes. I still recall the rhythmic undulations of the folds as the performers would twirl around, bow to the audience and with one flowing gesture remini-

scent of a Spanish matador, undo the capes, swirl them overhead and deposit them on the sawdust floor of the circus ring.

I also expected to derive a great deal of satisfaction and information from the lengthy processes involved in finishing a piece of handspun and handwoven cloth in excess of seven yards. So with fleece from American sheep, a spinning wheel crafted in New Zealand, a loom from Lima, Ohio and a Swedish sewing machine, I set out to construct a traditional Irish cloak. From the initial research to the time consuming processes of teasing, carding and spinning the fleece to the final finishing touches, it has been one learning experience after another. With surprisingly few frustrations, many insights and a new appreciation for the incredible persistence, resourcefulness and patience of the traditional cloth finishers (and after several months and 163.87 hours of labor) I present my findings and my version of the Irish Kinsale Cloak.

## HISTORICAL BACKGROUND

Although the Kinsale style cloak, or Munster Cloak, achieved its most widespread popularity in Ireland in the early seventeenth century, its origin dates back to a much earlier time.

First regional examples of a similar garment date to 700-800 A.D. rock carvings, while one of the earliest cloak forms, known by various terms including "brat", "fallainn", "lummon", "lend", "fuan" and "mantle", was worn before the Anglo-Norman invasion of the twelfth century. The brat has been described as an ankle-length, sleeveless, woolen cloak worn, at that time, by both sexes. Drawings and writings during this period show the added features of arm slits, embroidered borders and a brooch at the breast or shoulders for closure. The garment that later came to be recognized as the national female costume of Ireland had its inception here, beginning with the brat.

The brat or cloak had always been a prized possession, however cloaks represented much more than merely protection from the damp Irish weather. They were offered in tribute to kings, used as a commodity of interchange or merely for a bedroll while traveling. Those that were not handed down may have served as burial mantles.

Along with the obliteration of the Gaelic State in Ireland and Scotland at the end of the sixteenth century went the mode of Gaelic dress, banned by English legislation. It was at this point that the now distinctive hood surfaced, and became a vital characteristic of the Irish cloak. Dating back to c. 700-1500 A.D., it is a product of Moorish origin from the period of Saracen rule over Spain.

As an almost exclusively female garment, the cloak dominated during the eighteenth and early nine-

teenth centuries nationwide and can still be viewed today in a few regions of Ireland. Though both sexes and all classes made use of the cloak before this time (in varying colors and degrees of ornamentation), upon its evolution it became the trademark of the Irish countrywoman. Black became the preferred color for cloaks, making use of the prevalent natural black sheep fleece. The fabric, heavy and black, created an incredibly warm garment, yet the cloaks were worn in both summer and winter. Before the Potato Famine of 1847, accounts of Irish women working in the fields naked, except (in some cases) for these heavy outer garments, were common. During this time the female foot and leg were considered beautiful and generally left exposed, shoes not becoming the norm until this century. The trend at this time was also toward mixed company bathing, modesty not being a concern for the country class.

The actual production of the cloak fabric (and all other cloth) was initially a cottage industry in Ireland. An extended procedure, it was strictly women's work, except for the shearing of the sheep and, after the eleventh century, the fulling once the cloth had been woven. Women completed the tasks of sorting, teasing, scouring, and carding, spinning and weaving the wool into cloth.

Prior to the appearance of the fulling mills, fulling was performed in much the same manner as the quilting bee—a ritualistic gathering for the purpose of working and socializing. One of the most fascinating of all cloth finishing processes, fulling was, in all accounts, a communal effort, from the initial gathering of stale urine used to dissolve the grease to the actual fulling of the cloth. This was accomplished by the agitation of the woven cloth by a team of friends and relatives lining benches facing each other. While singing songs specifically designed for this activity called "waulking songs", the fullers kick the cloth back and forth

between themselves. The woman whose cloth is being fullled has the responsibility of keeping it damp with the urine and washing soda mixture and for rotating the cloth periodically to facilitate even fulling.

The idea behind fulling was to produce a tighter, warmer fabric. This was accomplished by shrinking and the loosening of the wool fibers to create a warm pile. This process continued until little or no light could be seen through the cloth. After a period of drying, this effect was further enhanced by brushing the fabric with a brush constructed of teasel heads, a thistle-like plant producing hooks so as to catch the fibers and create a long nap. A distinguishing feature, which came to be known as the Shaggy Irish Mantle finish, was a method that took the brushing one step further. After the brushing had been completed, honey was dabbed onto the fabric with a stick. It was then rubbed in a circular motion with various objects. Some preferred a piece of cork, while others used a bag of twenty to thirty small, smooth stones. Whatever the object the effect was the same—long tags of wool grouped together over the surface of the fabric which, ironically, resemble the initial fleece as it looks on the sheep.

The more loosely spun the wool was, the longer the nap and, therefore, the more distinctive the tags were. And while on the subject of spinning, mention should be made of its contribution to the whole. The spinning of fleece into wool was no easy task, keeping in mind that the spinning wheel was not invented until the fifteenth or sixteenth century. Prior to this time, all yarn was spun on the distaff and spindle by women in the home, and an enormous amount of yarn was needed to weave a web of fabric. On the average, woven cloth was finished in webs of twenty-five to forty yards at a time. Shrinkage averaged two to three inches per yard and depended on how vigorously and lengthy the fulling process had been.

When all the desired finishes had been completed, the cloth was then either sent to the tailors or made into the many garments needed to clothe the Irish family.

The fabric used in the construction of cloaks was of a particular weave. Normally a  $\frac{1}{2}$  twill with twenty or more epi and a relatively loosely spun weft yarn. The cloth was then treated to a number of finishing processes, which, in the final stages already described, allowed it to be labeled "frize", traditionally a fabric with the distinctively heavy curled or "frizzed" nap.

## CLOAK CONSTRUCTION

While I was determined to follow the traditional finishing techniques as closely as possible, a few steps were altered in the interest of convenience. While I had a rough idea of the yardage necessary, how much fleece did I need to complete a project of this size? How much would it shrink? How tight a weave would it produce? There were no set answers to my questions, so I took the project one step at a time.

I arbitrarily ordered fifteen pounds of dark fleece, thinking that it was better to have too much than too little. With the project now completed, I am left with enough black fleece to last me several years—6½ pounds. When the fleece arrived I discovered that all sheep are not color coordinated and that part of the fleece contained much more grey than the rest. Deciding to deal with this problem later, I began teasing the fleece in preparation for the carding process.

Carding the wool, even with the use of the drum carder, proved to be another time consuming process.

While the wool was not difficult to spin, it was slow going, as the yarn was somewhat thin. The more I spun, the more even the yarn became, so that I could judge the amount of wool and time needed to

spin one four ounce skein. Skeining and washing the yarn were welcome diversions from the spinning.

Warp yarn for the cloak fabric was one of the first modifications I made. Traditionally also of hand-spun yarns, I opted for purchased wool because of its strength, consistency and the time it would save. Twenty-two two ounce spools of Maypole Nehalem (3/12 wool worsted) were required to wind the warp. Other modifications made were a revised epi count from twenty to sixteen for ease of threading in an eight dent reed, and a change from the traditional  $\frac{2}{1}$  twill to a  $\frac{2}{2}$  twill, strictly for the purpose of accommodating my counterbalance loom.

Next to spinning, weaving was the most time consuming process. Information in my research alluded to the use of a fly shuttle in many instances, however, it was also common practice to weave twenty-five to forty yards at a time in order to provide cloth for all clothing needed by the family. I found the weaving to be one of the most enjoyable aspects of the project.

If weaving was the most pleasant activity, then surely fulling was the least! During the weaving process I had dutifully collected urine in anticipation of the fulling process. Over and over again in my research the term "stale" urine was emphasized. After collecting two gallons and letting it sit the suggested time of one week, I gathered my materials and headed for the basement. My initial idea was to full the cloth in the bathtub, but wanting to be as accurate as possible, I decided to try the process described in the research. The first step was to heat the urine mixture in a pail. To one gallon of urine I added 1/3 cup of washing soda, two gallons of water and three capfuls of Woolite, in an effort to disguise the odor. As this was heating, I placed a wooden door on the floor to take the place of the "twiggen" or wicker door. In an attempt to keep the liquid from running off the door

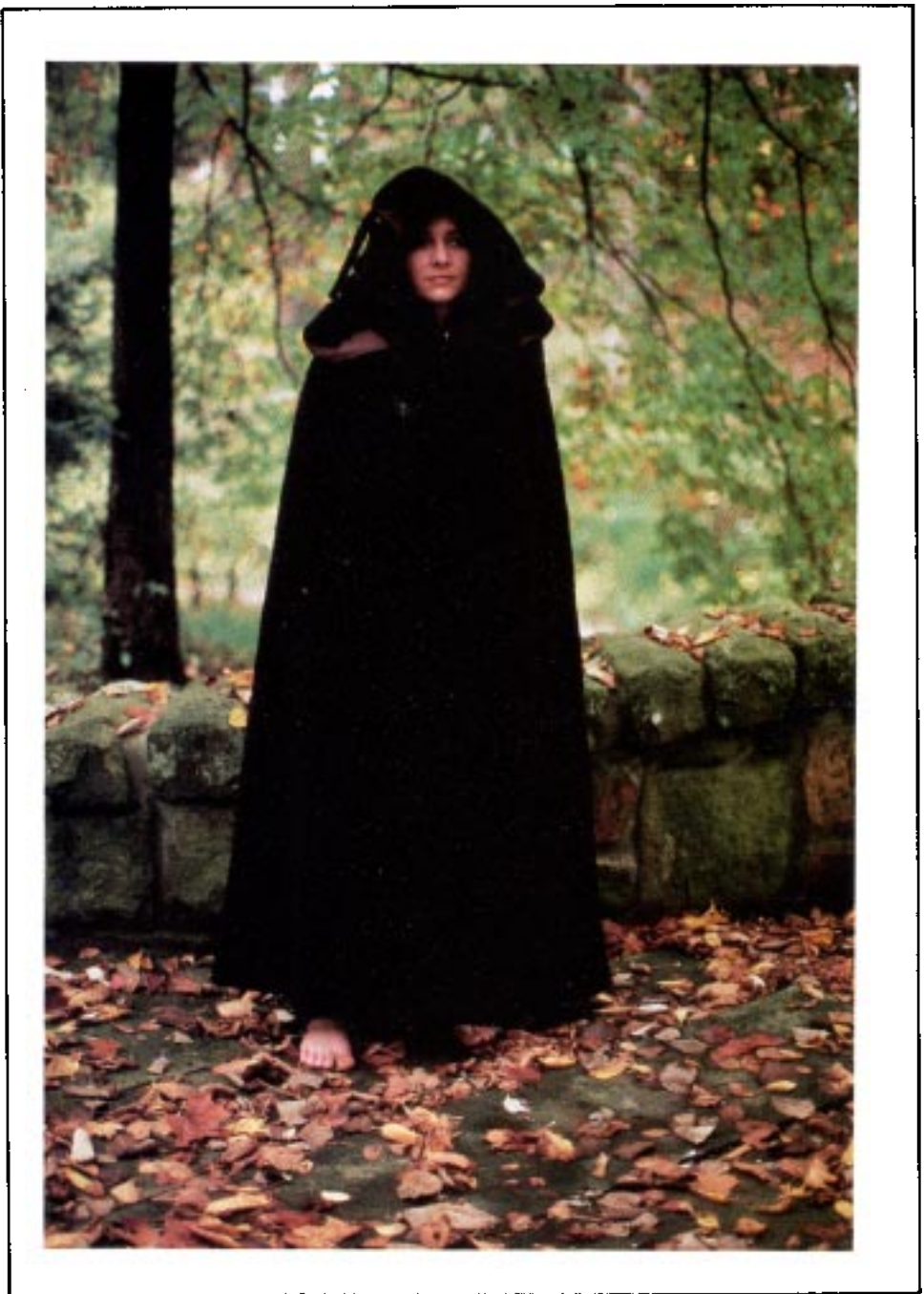

during the fulling process, I lined the door with a plastic sheet, elevating the edges with empty buckets. I had procured the reluctant services of my skeptical husband to aid me in the fulling process. I placed the cloth in a pile on the door, after having sewn the ends together to form a long loop of fabric. As instructed by my research, I "dashed" the material with the hot urine mixture. Each of us sat at opposite ends of the door and began fulling the cloth with our feet; back and forth as if riding a bicycle. Fulling in this manner was very exhausting. Also the

liquid was most uncomfortable to sit in.

As I attempted other methods of fulling, my most successful one was to place the cloth in a large, round plastic tub. I then began trampling the cloth, much the same as crushing grapes. This method had been described as an earlier form of fulling, dating back to Roman times, and was referred to by the Irish as "dancing on the cloth". At first, it shrank very slowly, but as it neared the four hour mark it had shrunk quite a bit. I allowed for this and had woven

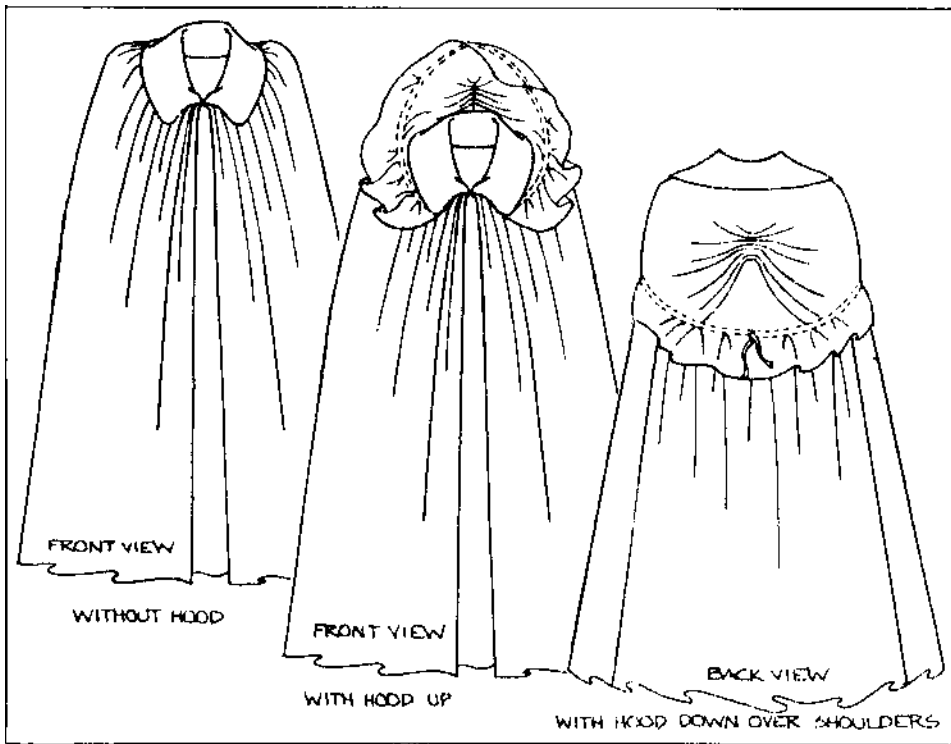

Kinsale Cloak: Folkwear pattern #207, available from Folkwear, P.O. Box 3859, Dept. AAU, San Rafael, CA 94912

7¼ yards instead of the 6¾ yards required for the cloak. I was also allowing for enough cloth for samples. Upon measuring the cloth for shrinkage I noted a difference in width of almost eight inches, from forty-one inches to thirty-three inches.

The cloth was then rinsed for a long period of time to remove the odor and soap. After letting it drip for a while, I then wrapped the yardage very tightly around a heavy dowel rod to remove wrinkles and puckers as it dried. I hung it to dry in this state for several days. A faint odor was still present so I unwound the cloth and allowed it to dry, draped loosely in the stairwell. It dried very quickly at this point and I was pleased that there was no odor to the cloth.

Traditionally a teasel brush is used for napping. The plants, specifically the variety called *Dipsacus fullonum*, were grown and cultivated mainly for this purpose. The long, hooked bracts allowed for maximum brushing while still treating the wool gently. I was unable to obtain a teasel brush in any reasonable amount of time, so my solution was to use a small cat

brush I found at the store. The teeth were angled as in wool carders but thinner and flexible so as not to tear the warp threads. I anchored the cloth tightly at one end and began brushing it in small sections. The brushing or napping took four hours and would have gone faster had I been able to find a larger brush.

I tried the Shaggy Irish Mantle finish on a sample of the cloth; applying honey and rubbing in a circular motion with pebbles in a handkerchief and then with a piece of cork. The effect was most successful using about thirty smooth pebbles wrapped in a handkerchief. I decided not to use this distinctive finish on my cloak.

I encountered few problems in sewing the cloak, except when attaching the hood and collar to the body of the cloak. The thickness of the seam—four wool thicknesses, two layers of lining and all the folds in the neckline—were almost too much for my machine.

Finishing touches seemed to be arbitrary on traditional cloaks, but were always understated. Occasionally borders on the front edges

of cloaks would be embroidered, and examples of jet bead or bugle work on the collars of some cloaks have been discovered. I chose a very simple brown cord, sewn into the seam of the collar as the only added ornamentation and a large silk covered hook and eye closure at the neck.

The cloak was normally worn with the hood hanging down around the shoulders in the back, the seven gathered pleats creating an effective contrast to the sleek simplicity of the body of the cloak. During very inclement weather, the hood could be raised and gathered with ties to offer protection for the head and face.

I persevered through a long, involved series of steps to produce the cloak, and I learned much in the process about Irish life and traditional cloth finishing techniques.

Now, how about some snow so I can wear this thing. . . .

#### Bibliography

- Encyclopedia of Ireland*. New York: McGraw Hill, 1968.
- Gordon, Beverly. *The Final Steps, Traditional Methods and Contemporary Applications for Finishing Cloth by Hand*. Loveland, Colorado: Interweave Press, Inc., 1982.
- Joyce, P. W. *A Social History of Ancient Ireland*, Vol. II. New York/London: Benjamin Blom, Inc., 1968.
- MacLysaght, Edward. *Irish Life in the Seventeenth Century*. New York: Barnes and Noble, Inc., 1969.
- Mac Manus, Seumas. *The Story of the Irish Race*. New York: The Devin-Adair Company, 1944.
- Oakes, Alma and Margot Hamilton Hill. *Rural Costume: Its Origin and Development in Western Europe and the British Isles*. London: B. t. Batsford, Ltd., 1970.
- Wilcox, R. Turner. *Folk and Festival Costume of the World*. New York: Charles Scribner and Sons, 1965.

**ABOUT THE AUTHOR:** Una Jones' interest in working with fiber includes weaving, stitchery, quilting by machine, felting, handmade paper, and photographic processes on fabric. She has exhibited at the Wearable Art Fashion Show and Exhibition in Charleston, W VA, May 1983; the Guild Gallery; and Exhibition 280 at the Huntington Galleries, entitled Works Off the Walls. In January 1983 she began a business called Center Ring Art which produces hand-woven clothing. Una studied art at the University of Florida and received her M.A. from Marshall University. She offers classes in spinning, dyeing, and weaving at the Huntington Galleries in Huntington, WVA.

# THE WOVEN SKIRT AND ITS DEVELOPMENT

by Anne Poussart



Jean Poussart

1. Skirt designed by Anne Poussart

The skirt is undeniably one of the most important items in our wardrobe, either by itself or coordinated with a jacket, pants or a coat. Even in the last century, the skirt was a very basic garment and the study of its fibers and patterns reveals features which are interesting to compare with today's handwoven skirts. Although very little information has been passed along to us on this subject, Dorothy Burnham, in her outstanding book, *Keep Me Warm One Night!*, helps us to establish a bridge between the past and the present.

We know what a great variety of fibers there are today: all the available colors, textures, blends of natural and synthetic fibers make it difficult for us to choose. But dur-

ing the past century, up to the time of the manufacture of spun cotton, the warp was always handspun linen. The wool weft, homespun and vegetal dyed, was the only means they had to achieve some innovations in color. Nevertheless, there were already efforts to use the cloth in a creative way. The looms were very simple (2 shafts) and did not allow variations in the weave structure. Stripes were the main design element. The warp, whether linen or cotton, was always plain. The stripes were produced by the weft.

Here are three illustrations of the use of weft pattern stripes:

1. **Weft stripes used horizontally.** The skirt was made with two identical panels, sewn together

along the selvages and sewn on a cotton yoke which gathers in the waist on a drawstring.

2. **Weft stripes used vertically with pleats.** The skirt was made from one long strip of cloth and was closed with one seam. The fullness was narrowed at the waist by means of pleats and held in place by a band of cotton or linen. The width of the fabric was equal to the length of the skirt and the stripes were placed to give emphasis to the pleats.

3. **Weft stripes used vertically with fabric cut in gores.** An example of such a skirt is shown in Dorothy Burnham's book, *The Comfortable Arts (L'art des étoffes)*.<sup>2</sup> This cut makes a skirt that is narrow at the waist and full

at the bottom. Yet, it does not violate the basic principle of the time: "Cloth is a large investment of labor. It has to be used without waste." This skirt is made from five gores, cut end on end (Fig. 1). This design allows the stripes to form decorative V's. The back seam is on the crosswise grain of the fabric (Figs. 1 and 2).

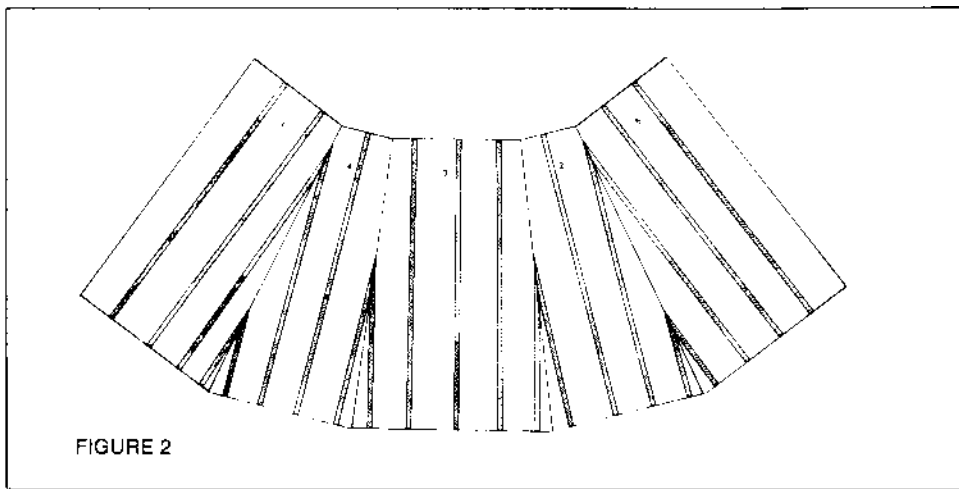
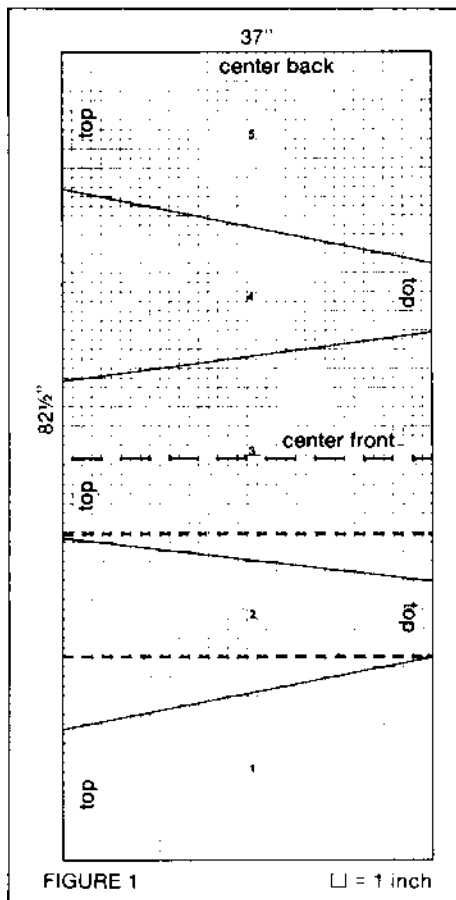

70's, handwoven skirts became popular at the time when fashion called for lower hemlines. At that time, I made skirts by using the fabric in the conventional way along the lengthwise grain of the cloth. Looms with 4 shafts or more made it possible to weave colorful and decorative bands in a variety of techniques: overshot, monk's belt, Summer and Winter, etc. Multishaft looms (6 or 8 shafts) gave the opportunity to weave block designs which could gradually decrease in size from the bottom to the top of the skirt.

Now that hemlines are higher, the visual balance of the garment requires a tighter control over the colors and the patterns and a toning down of the decorative elements. One can still use the design element of decreasing blocks but the effects must be more subtle. It is with this new style that the effects of vertical weft stripes become more useful. Since I have a small

production studio and never make two skirts alike, I find it advantageous to work with a plain warp. Regardless of the weave structure, the variety of my cloth depends on the weft colors and on the pattern of the weft stripes. A good fabric used in this way should have close to a 50/50 warp to weft ratio, and use fibers of similar strength. Because of the climate we have in Quebec, I often choose merino wool size 2/12 (3,360 yds/lb or 6,660 m/kg) set at 18 epi (70/10). This same wool, wound together with a finer wool (2/15 or 2/32) makes a good weft yarn. By alternating two shuttles and by weaving either at random or on opposites, I can play with several subtle color shadings and make the background of the cloth more interesting. The warp is set 36" (91.44 cm) wide and is 72-75" (2 m) long. After steam pressing, the piece measures 34 1/4" (87 cm) by 68-70" (1.79 m), which is plenty for any skirt (with or without pleats) up to size 16.

These three examples are the starting points for designing handwoven skirts today. During the

## Weave Rugs EASILY AT HOME

### MAKE GOOD PROFITS!

Fascinating full or spare time home business YOU can weave beautiful, serviceable rugs on low cost floor model loom that comes threaded, ready to weave - including accessories! Just a few days weaving pays cost of loom. For complete catalog, sample card, and low prices on warps and supplies - send 25¢. If you have loom, advise make and weaving width please.

**OR. RUG CO., Dept. 4330, Lima, Ohio 45802**

## JACOB ANGSTADT DESIGNS

*Jacob Angstadt*  
His Weavers Pattern Book

*Jacob Angstadt Designs*  
Drawn from  
His Weavers Pattern Book

**TWO BOOKS REVEAL 18th CENTURY MASTER WEAVER'S RECORDS**

A photographic replica of Jacob Angstadt's pattern book, 307 coverlet and tablecloth drafts: 237 tie ups for point twill drafts on 6, 8, 12, 16, 20, 24, 28 and 32 shafts. Companion book contains nearly 500 drawdowns from the profile drafts and point twill tie-ups. Designs adaptable to unit weaves on 5 to 10 shafts. Prepared by Ruth N. Holroyd with Ulrike L. Beck.  
8 1/2 x 11" Hardbound set totaling 400 pages. \$39.95 per set\*

**Published & Distributed by:**  
Ruth N. Holroyd  
20 Old Farm Circle  
Pittsford, N. Y. 14534 U.S.A.

Add \$2.00 Postage & Packaging (\$3.00 overseas) per set. \*N.Y. State Residents add 7% tax - Dealer inquiries invited.

**NOW AVAILABLE!**  
Seminar or Workshop: "Playing with Profiles", Interchanging unit weave systems within multi-harness profiles. Inquire: Ruth N. Holroyd, Instructor



## SUGGESTIONS FOR USING PATTERN STRIPES

1. Two overlapping pleats folded along the stripes. The pleats are on the left front of the skirt. The back is plain. See Photo 1. The stripes are about 1 3/4" (4 cm) wide.
2. A center front stripe is framed by two pleats on each side, the pleat turned toward the center. See Photo 2.
3. Two wider bands frame a buttoned down center. This is accentuated by a pleat on either side turning toward the outside. See Photo 3 and Fig. 3.

In the last two styles, the back panel and the front panels are seamed together at the back darts (Fig. 3). A long dart or a slight gather shapes the hips. The dart is preferred for heavy fabric such as

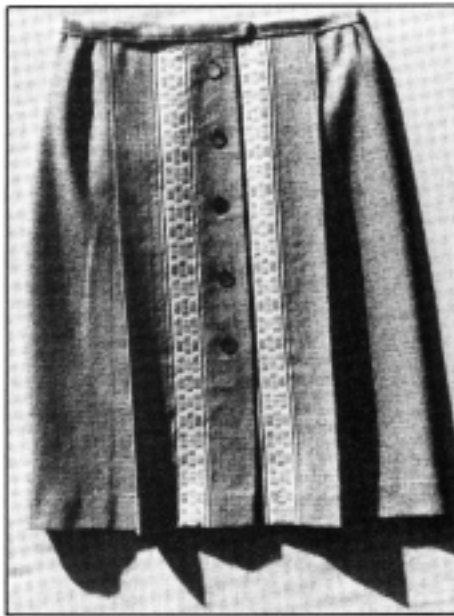

3. Skirt

yardage woven with wool tweed singles set at 16 epi (70/10). The width of the cloth, now the length of the skirt, has enough allowance to yield a belt alongside the selvedge (warpway belt). If one prefers a belt embellished with a weft-way pattern, one needs to weave an additional pattern stripe at the end of the required yardage. Any motif, whether 4" (10 cm) or 1-2" (2.5-5cm) wide, is more effective if it is outlined by one or more narrow stripes, plain or textured. A threading such as Rosepath is a good one to start experimenting with for this type of skirt. In fact, a piece of yardage with 4-5" (10-13 cm) of plain cloth and one or more pattern stripes at each end, can be held in front of a mirror and draped around the figure to discover the many ways in which the fabric can be used. These are numerous because the patterns, instead of being obvious, can also be planned on the inside of pleats and reveal themselves only when the wearer is moving.

A fabric with continuous weft stripes, woven with four or more shuttles, may be cut in panels or gores which are narrower than those shown in Fig. 2. This would give the fabric a stunning fashionable look.

Skirts can be coordinated with handwoven shawls or scarves.

Moreover, it is the only handwoven garment that can easily be coordinated with knits. Because of the choice of yarns available, it is easy to pick weaving yarns and knitting yarns that match. The same type of wool often comes in different sizes, such as one ply and two ply. The two ply usually is a good knitting yarn of medium weight. Thinner yarns, such as 2/12 wool, are best suited for knitting machines.

Truly, the handwoven skirt is a field for unlimited experimentation.

## Bibliography

1. Burnham, Harold B. and Dorothy K., *Keep Me Warm One Night* © 1976 University of Toronto Press pp. 63-64 (#75, #76); p. 76 (#93).
2. Burnham, Dorothy K., *The Comfortable Arts* © 1981 National Museums of Canada, Ottawa p. 138 (#99).

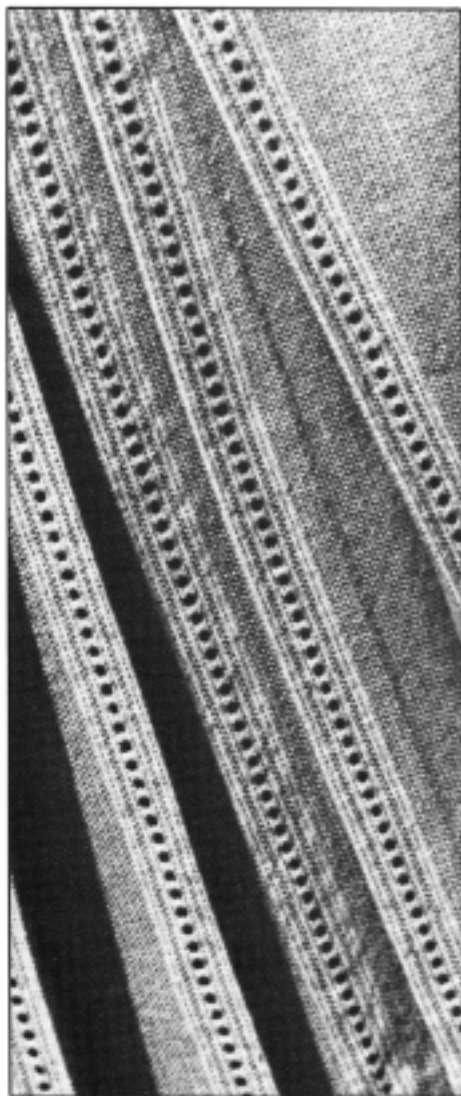

2. Skirt center front stripe detail

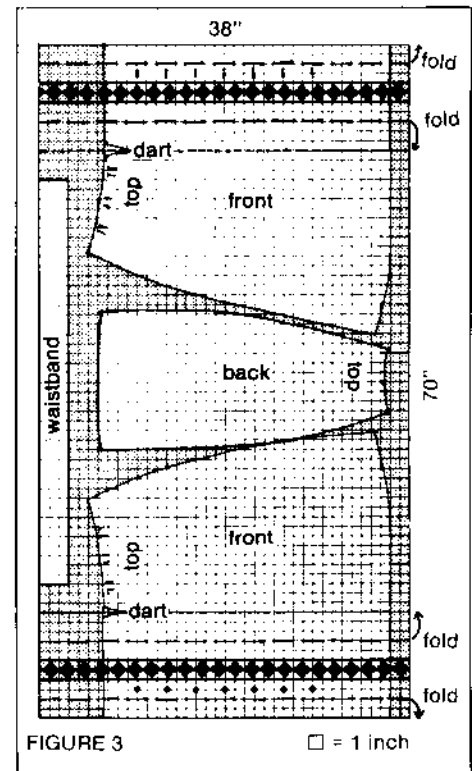

**ABOUT THE AUTHOR:** Anne Poussart is a member of the Corporation of Craftsmen of Quebec with whom she has participated in six shows. She is also a member of the Association of Creative Weavers and has been teaching the "Concept and Finishing of Handwoven Cloth and Garments" for over six years. This article resulted from a workshop Anne Poussart gave at the Conference of the Guilds of Quebec, held in May 1983.

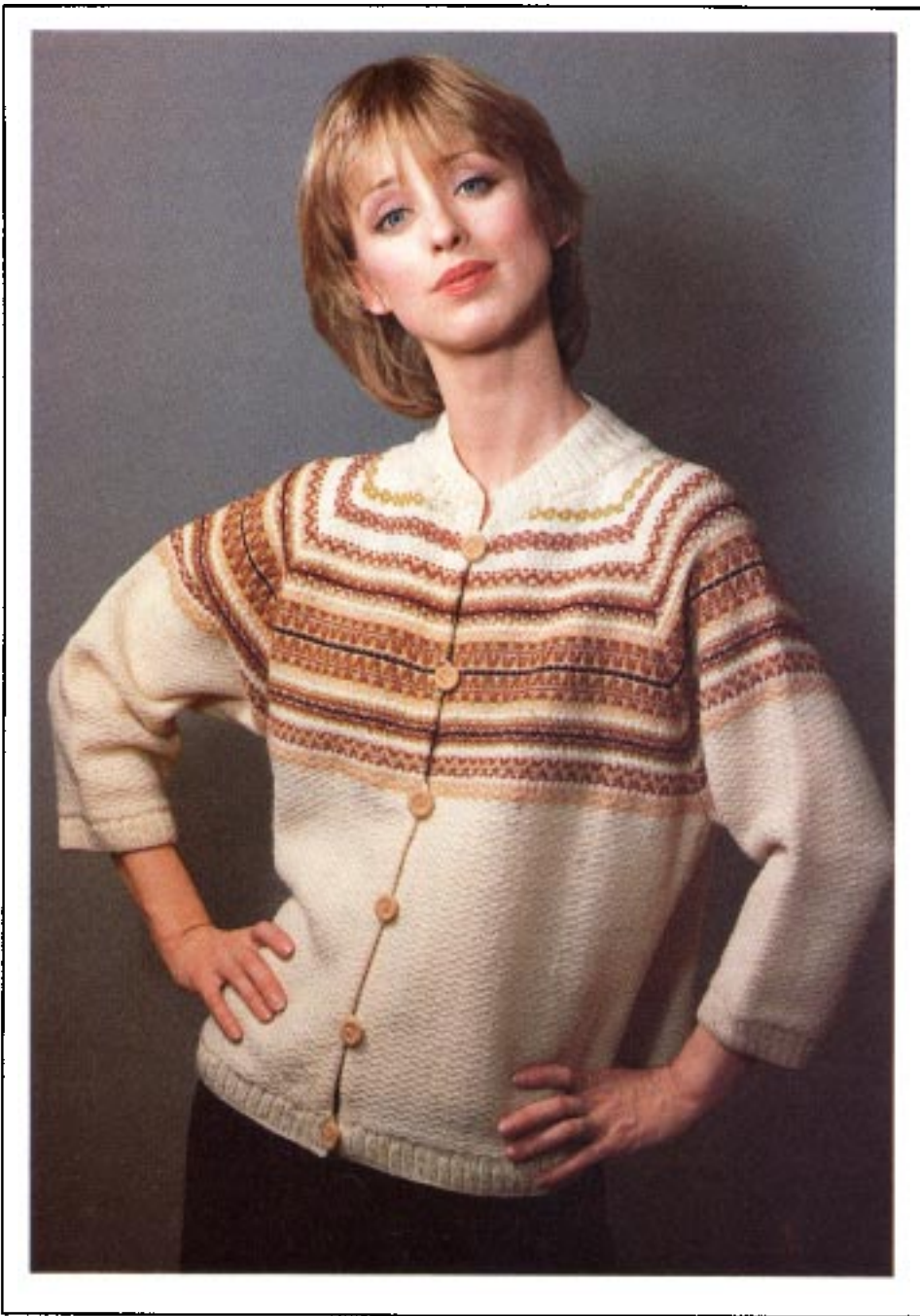

Scandia jacket designed by Kay Small

## SCANDIA JACKET

Kay Small's comfortable garment combines ethnic inspiration with the whites, off whites, and natural look which is so appealing this year. A pattern in Scandinavian mood dances across the plain white ground, joining the raglan sleeves with a delightful yoked design. Created with both eye-catching good looks and versatility in mind, you will want to take it on every trip and special outing.

This is a warp-pattern weave, with colors arranged in the warp to correspond to the threading draft. The weave requires only a one-color weft and simple treading.

The length of the jacket lies across the warp. See Fig. 1. The angle cut for the raglan sleeve turns the stripes to form the yoke design. The warp pattern simplifies matching the stripes.

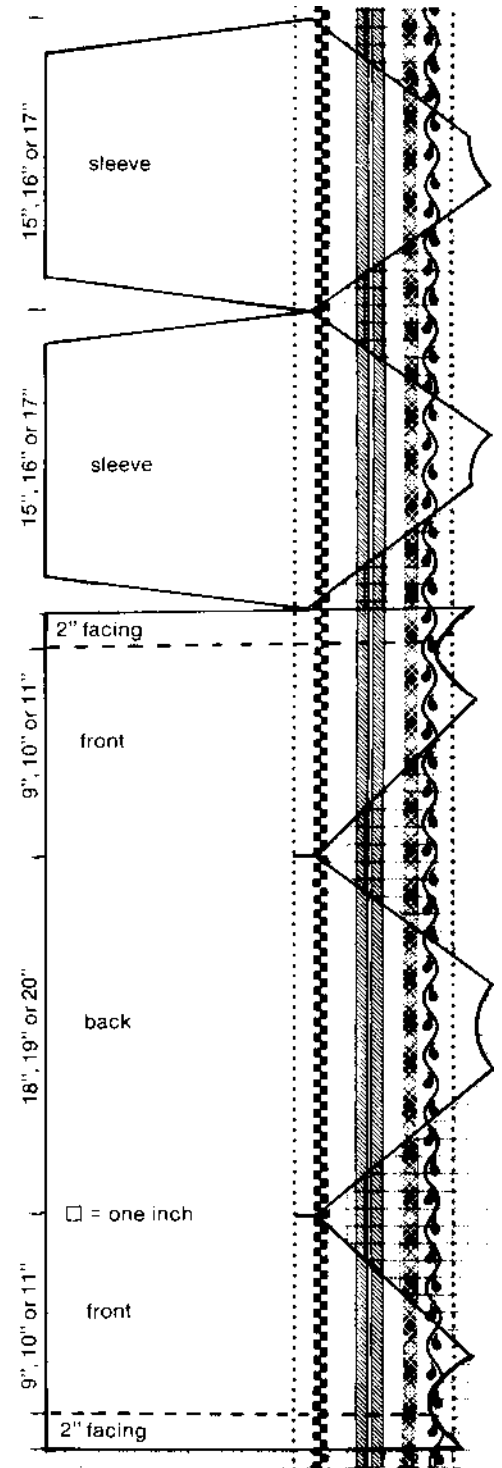

FIGURE 1. Cutting Chart sized for small, medium and large. Transfer diagram to full size pattern.

### Warp

**ground:** wool or orlon, 3-ply sock and sweater yarn, 160 yds. per ounce.

**pattern:** 4-ply sports yarn, 110 yds. per ounce; colors: light blue, bright blue, violet.

**Weft:** Same as ground warp, although it is preferable to use weft yarn that is a little thinner than the warp yarn. The yarns are elas-

	start																				end	totals
white	50	8	9	1	4		4		4	1	1	1	4			5	1	4	8	204	322	
lt. shade		4				4	2	4						2	2	4			4		22	
medium			9				2	2		1		1		4	2	4			8		43	
dark				1	1					4		1	4				1	1			20	
				4 X						6 X		2 X	6 X				4 X				407	

Warp color sequence. Beam on loom with pattern band to weaver's right.

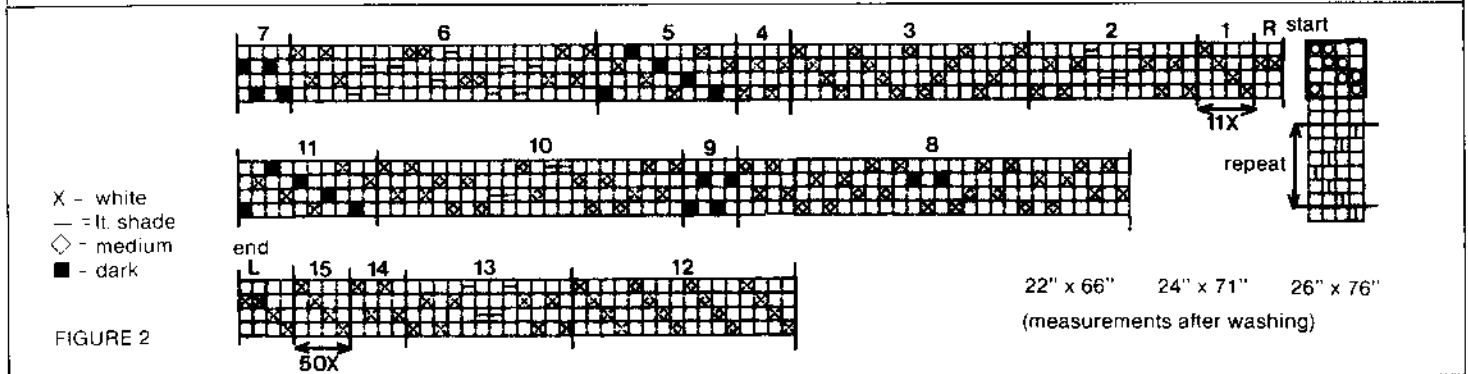

tic while weaving, but the finished material is unstretchable, so be careful not to overbeat. Weave 15 picks per inch.

**Sett:** 15 epi (60/10 cm)

**Warp color sequence:** The warp must have the major color band beamed on the right of the weaver to have the colors placed correctly for threading.

**Width in the reed:** 27" (67.5 cm) This is for a size medium (size 10). The pattern band measures 10½" (26 cm) wide. As the length of the jacket lies across the warp, for a longer jacket the width of the warp must be increased. To increase the length, add to #15 in the threading draft.

**Length of the warp:** 3½ yds. (3.2 m). This includes loom allowance. This is for a size medium (size 10).

**Total number of warp ends:** 407 total consisting of: 322 white, 22 light shade, 43 medium, 20 dark.

**Threading, tie-up and treadling:** See Fig. 2. For good selvedge, note "start" and "end" threading.

**Finishing the cloth:** Release the tension before taking measurements because the warp is stretchy. Machine stitch cut ends and machine wash in cold water on gentle cycle. Hang to dry. Do not use dryer. There is little shrinkage if orlon yarns are used.

Standard sizes	Bust	Back length*	Yardage on loom**
10 small	32/34	22"	82"
14 medium	36/38	24"	89"
20 large	40/42	26"	96"

\*includes 20% shrinkage      \*\*add loom allowance

**Cutting the material:** See Fig. 1. It is a good idea to transfer the diagram to a full size pattern. Pattern paper marked with 1" grid is available in yardage stores.

**Assembly:** Pin the pattern to the right side of your handwoven fabric. Mark cutting lines with tailor's chalk or basting thread. Remove pattern. Baste seam binding close to cutting line. Machine stitch binding to material, then cut fabric. Machine stitch, but do not bind, neckline. Fold binding over cut edge, stitch down.

At bottom of armhole V, stitch for a ¼" slash. See Fig. 3. Whip bottom of slash by hand, to strengthen, then cut.

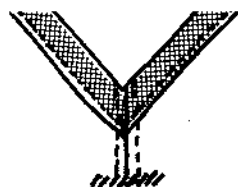

FIGURE 3. Underarm slash and whipping.

Fit the longer shoulder seam to back of jacket, lining up the weave exactly. Pin, then baste into position. Fit the front seams, baste. Allow for the sleeve seam when bringing the seams together at the V.

When lined up, machine stitch the shoulder seams. Machine stitch the sleeve seams. If necessary, stay stitch the join by hand before machine sewing.

Press all seams open. Check neckline: it should measure 15" to 17" with the facing folded into place. Bind neckline with seam binding. To avoid bulk, bind the neck with the facing flat, then fold into place and tack.

The original design was finished with hand-knit bands at neck, wrists and hem, and a button at the neck only. The weaving yarn was used for the knit. Edges could be crocheted. An alternate finish would be to face the neck, and leave the selvedge edge at the bottom of the sleeves and the hem. If you like, close down the front with buttons and loops, or a jacket zipper.

**ABOUT THE DESIGNER:** Kay Small was born into a family of expert needlewomen, and grew up surrounded by the many phases of the dress trades. She began weaving in 1950. She has studied with Mary Snyder and Lee Barkley. In 1970, with her family grown and gone, Kay turned professional. She maintains her own studio and teaches for Coastline Community College. Her time is equally divided between teaching, custom weaving, and designing weaving patterns such as the Scandia jacket.



Robert Mellis

Eight-shaft crackle weave was used for the design of the violet stole shown.

Crackle weave is a supplementary weft weave. The ground weave is plain weave. The pattern weft makes short floats. The design area is woven by alternating a tabby pick and a pattern pick. Design wise, crackle permits one to weave larger pattern blocks made up of specific threading units that may be repeated ad lib. The weave structure of each block is based on a 3-shaft point twill. Block A is threaded according to Fig. 1a. Note that the block is balanced with a warp end on shaft 1. Block B is threaded according to Fig. 1b. The block is balanced with a warp thread on shaft 2. Block C is threaded according to Fig. 1c. The block is balanced with a warp thread on shaft 3, etc.

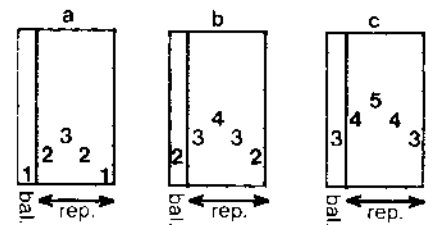

FIGURE 1

## VIOLET VESTMENT by Roslyn Hahn

Many weavers are inspired to create handwoven vestments for their clergy. However, often the fabric is woven, then embellished with embroidery after it is removed from the loom. There are a number of techniques which can be used to embellish during the weaving of the fabric. One of these techniques which is easily adapted to the cross design is crackle weave or Jamtlandsvav.

The creation of a clergyman's stole is a good starting point for liturgical weaving. The standard size is 5" x 96" (12.7 cm x 244 cm) plus fringe but this varies according to

personal preference.

The eight-shaft crackle weave stole shown here was designed and woven to be used during the Lenten season. The symbolism of the elevated Latin cross and the three-step Trinity cross is appropriate for Lent, as are the selected colors. Violet symbolizes penitence, passion and suffering.

The placement of the design may vary according to preference but, by placing it chest high, the churchgoers can see it even when the clergyman is behind the pulpit. A similar design is repeated near the bottom hem for balance.

Robert Mellis

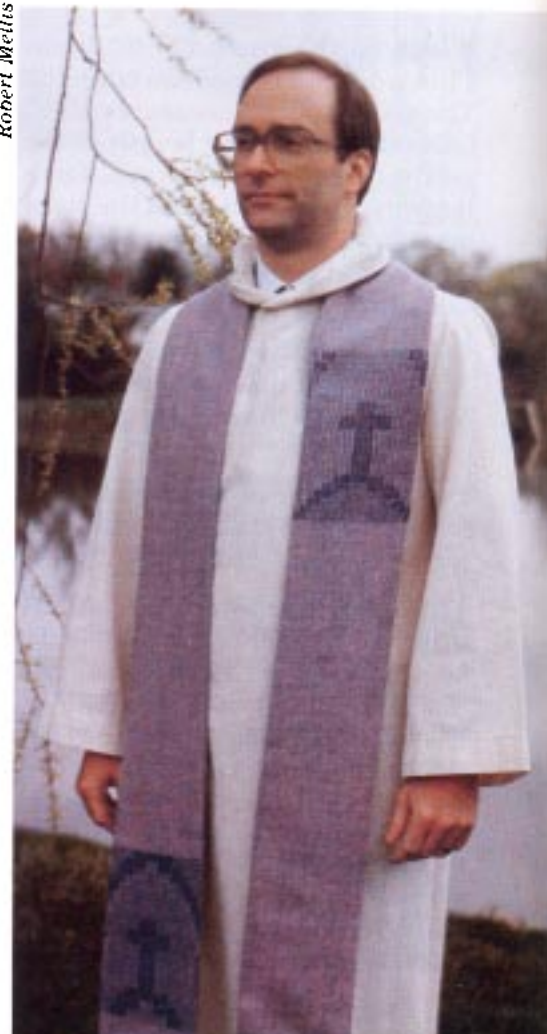

**Warp:** wool singles (2,000 yds/lb, 4,000 m/kg) (Harrisville Designs); color: lilac. I selected lilac because of the subtle color blending within the yarn.

**Weft:**

**tabby:** Same as warp

**pattern:** Same as warp; colors: navy, aubergine (purple)

**Yarn requirements:** 1 lb. (454g) lilac, 1 oz. each of navy and aubergine (28, 35g)

**Sett:** 15 epi (60/10)

**Width of the warp:** 18.9" (48 cm)

**Length of the warp:** 4½ yards (4 m), which includes one yard waste

**Pattern and profile draft of the block arrangement:** See Fig. 2.

**Threading:** See Fig. 3. There are a total of 127 warp ends.

**Weaving plan:** See Fig. 6.

**Weaving pattern #1:** See Fig. 4. Alternate a tabby pick and a pattern pick.

**Weaving pattern #2:** See Fig. 5. Alternate a tabby pick and a pattern pick.

**Finishing:** The fabric is finished first by steaming then hand washing with Ivory Liquid for three minutes. Rinse until water is clear. Roll in a towel to remove excess moisture and dry flat. Steam.

**Construction:** Begin assembling the stole by cutting the handwoven fabric in half and cutting two lining pieces and two interfacing pieces the same size as the stole pieces. Lay one half of the handwoven stole on the table top with the right side up, place a lining piece right side down and top with a piece of interfacing. Pin all three layers together with pin heads toward the edge of the fabric. Mark the neck edge pattern on the interfacing, using Fig. 5 as a guide. Cut all pieces to proper size at neck edge. Sew side seams together on the sewing machine, carefully removing the pins. I prefer to sew with the handwoven fabric on top so that any bubbling that may occur can be eased in carefully.

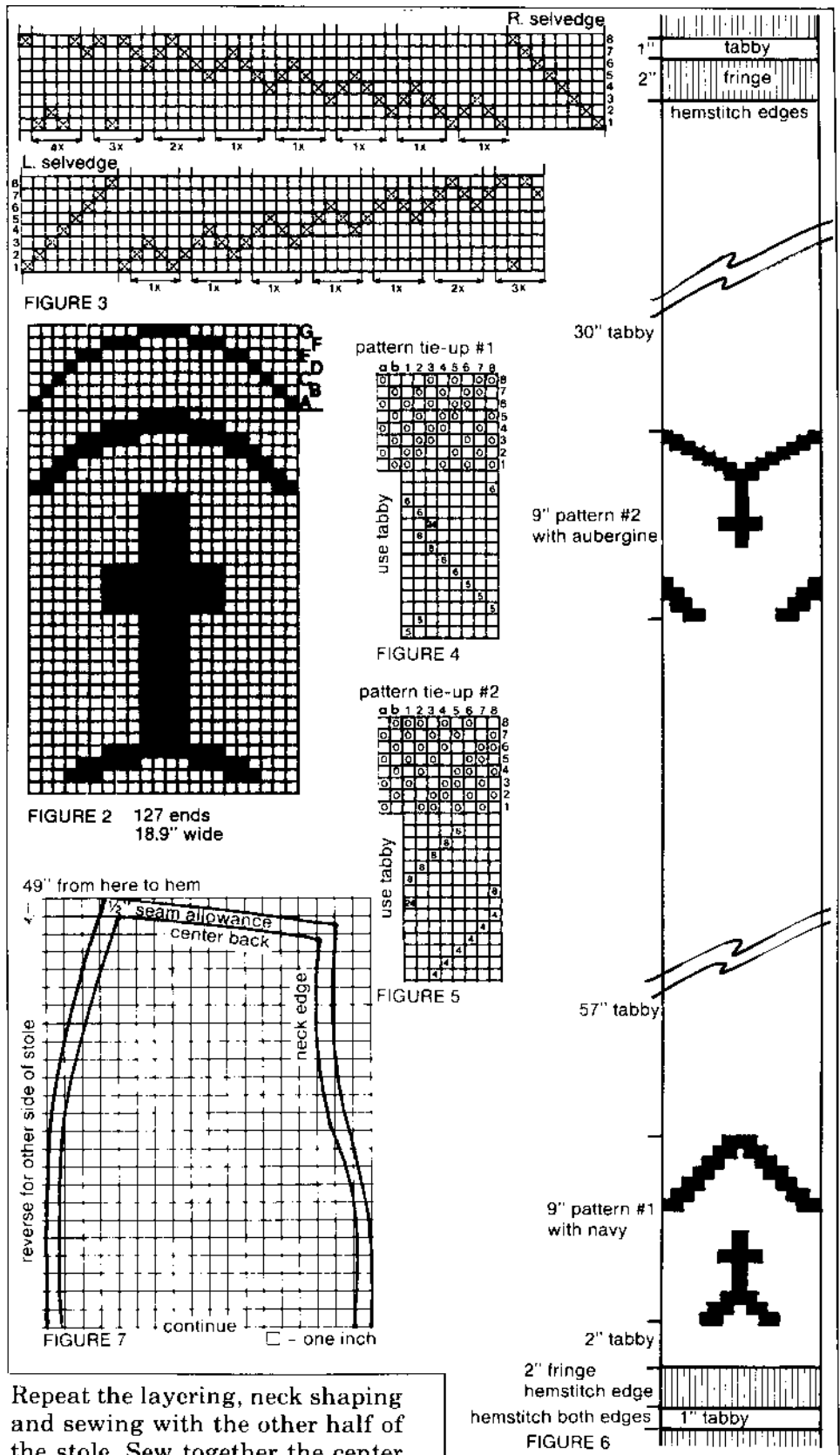

Repeat the layering, neck shaping and sewing with the other half of the stole. Sew together the center back seam of handwoven fabric, making sure right sides are together. Sew together center back seam of the lining. Trim interfacing and lining. Zig-zag any raw edges. Turn the stole right side out. Steam press carefully. Turn up hem and handstitch.

*ABOUT THE AUTHOR: Roslyn Hahn is from Warren, Ohio. Her interest in liturgical weaving began three years ago. Since that time she has been compiling information and experimenting with techniques and ideas. Roslyn Hahn offered a program during the 1983 Midwest Conference in which she gave basic background information to weavers who wish to do liturgical weaving.*



## HAPPY DRESS

by Elserine Sprenger

Looking at the grey skies and dull-brown grass of February, I decided to create something light-hearted; something very bright and very colorful. Inspired by folklore dresses of many cultures and techniques, I conceived this whimsical *Happy Dress*. The pattern of the dress is a revised version of one of my old Indian cotton dresses; the design for the yoke has a Japanese touch; and the idea for the cotton strips was derived from the basic Seminole Indian patchwork technique. The dress is made with commercial fabric and a hand-woven yoke.

### THE YOKES

The yoke is loom shaped and loom embroidered. The weave of the yoke is a variation on whole dukagang found in *New Key to Weaving*, p. 124. This uses only three shafts which make it suitable for a jack-type loom. However, I have woven this pattern on a counter-balance loom by reversing the tie-up and tying shafts 3 and 4 together, which works equally well.

**Warp:** 8/2 cotton in navy blue

**Sett:** 12 epi (50/10 cm)

### Weft

**ground:** 8/2 cotton in navy blue  
**pattern:** 5/2 perle cotton in 11 colors for the floral design

**Threading, tie-up, and treadling:** See Fig. 1. Alternate a ground pick and a pick of pattern weft.

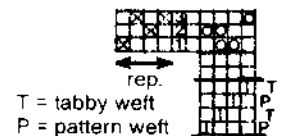

FIGURE 1

**Pattern:** If you like to use your own design for the yoke, allow 10% shrinkage, 1" intake and for the seams of the dress, when drawing your cartoon.

**Technique:** The design is woven with the wrong side facing the weaver. This allows all threads to be on top of your work so they do not obscure the cartoon below your work. Check the underside or right side for errors with a hand mirror.

To avoid confusion and mistakes, all threads in one pattern shot have to go in the same direction. On the next pattern shot the colors interlock as in Fig. 2. The traditional weaver might be horrified at this, but I don't use butterflies or anything else to keep my threads organized during weaving. I find it much quicker to use pieces of thread no longer than 30". The thread runs easily through the fingers and the warp, and it is short enough not to get tangled. It is necessary to use a separate thread for each color area; that is, if navy blue appears in two positions in the design, two navy blue threads must be used. Prepare yourself for using up to 18 different threads in one shot!



FIGURE 2. Changing color, wrong side facing the weaver. P = pattern weft T = tabby weft

For the entire yoke, alternate a ground pick (tabby) with a row of pattern wefts. See Fig. 1. The pattern wefts fill the background as well as the flower design. To weave the pattern, open the pattern shed as shown in Fig. 1 and lift the warp

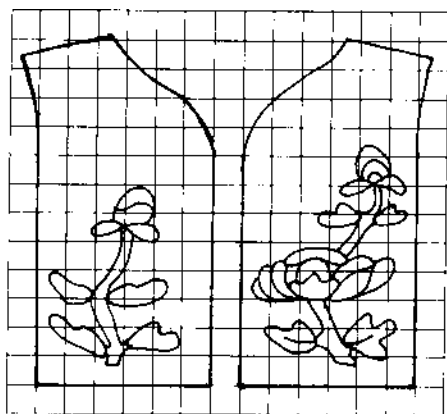

FIGURE 3. Front yoke plan □ = one inch

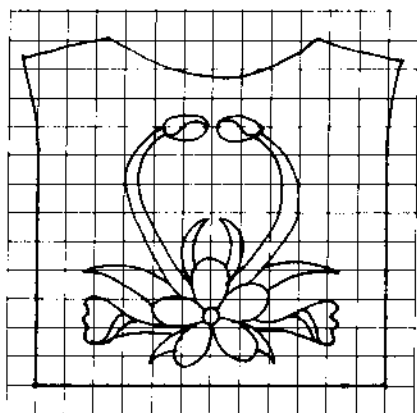

FIGURE 4. Back yoke plan

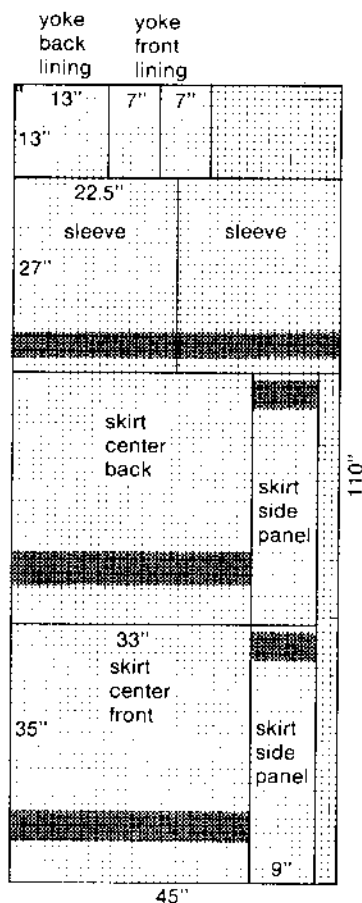

FIGURE 6. Cutting diagram for basic red dress, size medium. □ = one inch



threads of shaft 3 within the outline of the area to be woven with the color on hand. Change color, lift the warp threads of shaft 3 within the outline of the next color area. Continue across the entire width of the fabric. You will be surprised how easy it is, and how rewarding it is to see your design develop.

The front yokes are woven on the same warp as the back yoke, but with four rather than two selvages. See Figs. 3 and 4.

**Finishing:** After weaving the yokes, the ends are machine zig-zag stitched twice. Then the yokes are machine washed on a gentle cycle for two minutes with a mild soap. To protect the fabric, I put the weaving inside a pillowcase during washing. The fabric is laid flat to dry and gently pressed to finish.

### THE DRESS

The dress is made of cheerful polyester-cotton fabrics. The basic

fabric is red. It has a full gathered skirt. All the pieces, except the lining of the yoke, are rectangles. See Figs. 5 and 6 for measurements and cutting pattern. When cutting the patchwork fabrics according to Fig. 5, remember to allow 1/2" for seams and 3" for the hem. Do the patchwork before assembling the dress.

### Assembly:

- First close the shoulder seams of the woven yoke. Then sew the sleeves onto the yoke. When sewing the underarm seam, leave open the last 4" (10 cm) near yoke.
- Assemble the four sections of the skirt, marking the center front, back, and sides. Gather the skirt.
- Sew the skirt onto the yoke and partially onto the sleeves by matching the center front, back, and side sections of the skirt with the underarm seam.

- Line the yoke. Make four braids of pearl cotton 12" (30 cm) long for

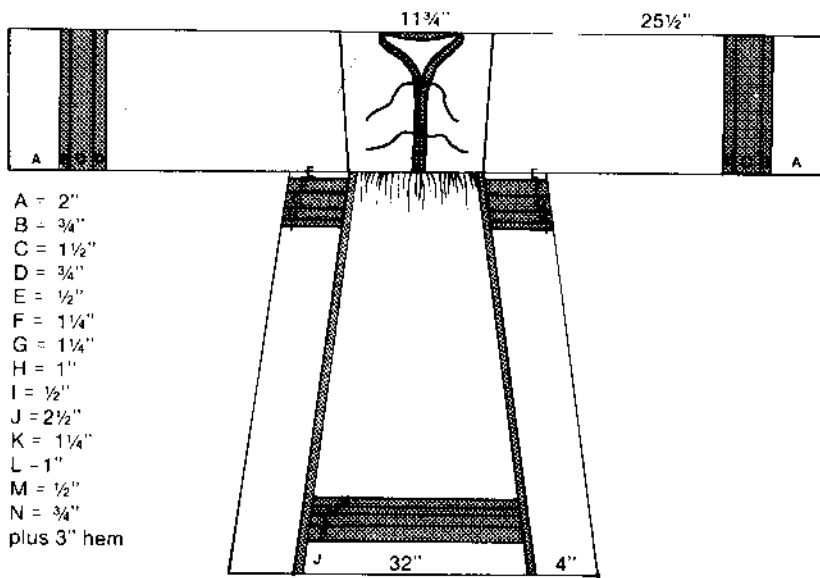

FIGURE 5. Assembly diagram

the front. Gather the sleeves at the cuffs. Finish the sleeves and neckline with the strips of cotton braid as with biastape. Hand-hem the skirt.

**Washing:** The dress should be hand-washed and hung to dry. When it is nearly dry, put it in the drier for about five minutes for crispness of cotton.

**References**

Black, Mary E., *New Key to Weaving*, MacMillan Publishing Co., New York, 1957.  
 Porcella, Yvonne, *Pieced Clothing*, Porcella Studios, 1980.  
*Japanese design motifs* compiled by Matsuya Piece-Goods Store, Dover Publications, Inc., 1972.

**ORDER ALL YOUR WEAVING, SPINNING, DYEING BOOKS AT DISCOUNT**

Any good, standard Classics and many New Titles  
 Also Needlework, Hobbies, Crafts, Dolls, Miniatures  
 10% discount on any U.S. books

Please send SASE with your inquiry.

**KATHERINE RAMUS      2100 E. EASTMAN AVE.,      ENGLEWOOD, CO 80110**

**MACOMBER  
 LOOMS**

THE KEY TO YOUR  
 WEAVING DESIGNS

**DESIGNER'S  
 DELIGHT®**

THE DOBBY WITH A  
 DIFFERENCE

**Beech Ridge Road  
 York, ME 03909  
 207-363-2808**

**MACOMBER LOOMS**

A microcomputer that controls the harness tie up and treading sequence of your pattern. You can add it on to your standard Macomber loom in less than one hour with simple tools, or order as an accessory on your new Macomber loom giving you two looms for the price of one conventional dobby loom.

Conventional dobby looms lock the weaver into a preprogrammed pattern without allowing for correction or modification of the pattern during weaving.

The DESIGNER'S DELIGHT overcomes this limitation with three selection modes.

*Design Mode*-design, change, correct, and record the pattern as you weave it.

*Automatic Mode*-preprogram your pattern, step on the pedal, throw the shuttle and weave.

*Manual Mode*-when you just want to play or experiment and not record your pattern.

In addition your pattern may be displayed at any time on the L.E.D. display. The DESIGNER'S DELIGHT features single pedal operation, permanent storage of your tie up, and permanent storage of your treading sequence on separate keys for future use. For example you may use the same tie up key but different treading keys for many patterns.

This unique yet simple device allows us to offer up to 32 harnesses capacity in 24"-72" weaving widths with single pedal operation.

**Get the best! Buy a MACOMBER LOOM.  
 Ask the weaver who owns one.**

For further information call or write  
**MACOMBER LOOMS Beech Ridge Road York, ME 03909 207-363-2808**



# DISCOVER COTTON SPINNING

by Norma Ajeman and

Irene Laughing Cloud Schmoller

Don't let anyone tell you that you cannot spin cotton! Throw away those ideas that cotton is just too hard to spin. Rid yourself of the notion that you need special tools and equipment before you can even try cotton. Open your mind and heart to cotton and allow yourself the pleasure of discovering the joys of cotton spinning. Cotton is fast becoming the fiber for the 80's, so there is no reason in the world why you should not incorporate hand-spun cotton into your weaving, knitting and crochet handmades.

There is little wonder why cotton is gaining recognition as the number one fiber. If you have ever worn a 100% cotton garment you can attest to its superior feel of comfort next to your skin. Cotton is non-irritating, never itchy or scratchy and easily worn by people allergic to wool or synthetic fibers. As a cellulose fiber, cotton absorbs body moisture and evaporates it into the surrounding air, thus allowing your body its natural function of breathing and keeping you cool in summer, dry and warm in winter. Not only are you more comfortable in cotton, you are healthier for wearing it.

Cotton combines many qualities that add up to dependable performance. It is durable and strong, having a high tensile strength. Surprisingly, it is 30% stronger when wet, will withstand repeated washings in the hottest water, accepts the fastest dyes, and doesn't build up static electricity which causes fabrics to cling and soil easily. You always look and feel better about yourself in cotton.

## GETTING TO KNOW COTTON

The basic principles of spinning apply to cotton spinning as well.

Your finished garment or project will be only as good as the materials you put into it. A quality yarn can come only from quality fibers. Once you become familiar with the variety of cotton fibers available, you will be able to choose the fiber that is right for you. Cotton spinning is unique in itself. Although the same basic technical principles apply, you cannot compare it to spinning any other fiber. There is not the elastic tension of barbed scales catching one upon the other that you find in wool spinning. The long-draw is nothing like the fluid drawing-out process involved in silk spinning. But there is a beauty in spinning cotton; watching the slubs pull themselves out as you slowly attenuate your cotton thread; feeling the soft, slightly waxy fibers leave your hand to become cotton yarn. There is a gentle tension as the convoluted ribbon-like fibers catch one upon the other. In spinning cotton, you must understand the fiber and flow with the gift that nature has given you. Knowing the correct techniques of spinning cotton will open a door to the world of softness, luxury and comfort.

## UPLAND COTTON (SHORT STAPLE)

Upland cotton, King Cotton of the Old South, is still being grown today in a belt of states from North Carolina to California. This Upland cotton has a staple length of up to one inch (25 mm) with a matte or velvety appearance. The Upland tends toward a white color with grey or bluish overtones. Ginned short staple cotton is not always recommended for beginning cotton spinners. Depending on the quality of the cotton and the ginning process, this very short-staple fiber can vary considerably in its ease of spinning. If you have ever tried to

spin cotton and failed, most likely you were trying to spin short-staple cotton. Although many beautiful yarns have been spun with this cotton, care must be taken in fiber preparation and spinning.

## PIMA COTTON (LONG STAPLE)

Pima cotton, the accepted generic term for all American Egyptian cottons, was developed in Arizona and named after the local Pima Indians, who in their own times and culture had grown, spun and worn cotton. First introduced into the fields in 1912, a variety of Egyptian and Sea Island cotton, Pima has been experimentally improved for high yields and an extra-long staple. This extra-long staple (1¼" to 2+" ) was developed for its strength, durability, luster and silkiness. Pima cotton has a rich, creamy-white color and is super-soft. Once you have spun Pima cotton you will agree that it is the Princess of Cotton.

## BROWN COTTON

Wild cotton grows on the warm, rocky slopes of southeastern Arizona and northern Mexico's mountains. When it produces tiny seed hairs, the color is brown. Varieties of white cotton being grown today began as white mutants of native brown cottons. Groups of isolated Mexican Indians who grow, spin and weave brown cotton exclusively, were convinced that the first American cotton they saw was *bleached*. Quetzalcoatl, the ancient Mexican god, was believed to have taught his people to grow four colors of cotton. Brown cotton available to handspinners is a shorter and coarser staple variety ranging in color from a soft tan to a deeper earthy umber. Much hand labor in growing and extraordinary care in ginning has been responsible for the high price

handspinners had to pay for this specialty cotton. It can, however, be combined with other cottons in fiber preparation and spinning to produce subtle shading and stripes in almost every handmade. In this way, a small amount of brown cotton can be made to go a long way.

## FIBER PREPARATION

You do not need to invest in specialized tools or expensive equipment to learn to spin cotton. Although these tools will make the learning process easier and the spun yarn of a higher quality, you can take the initial plunge into cotton spinning without them.

Most ginned cotton, whether white or brown, that you purchase will have been compressed in a 500 pound bale the size of a kitchen refrigerator. Naturally, it is matted with knots and snarls and very compressed. You can decompress your cotton by steaming it in a colander over rapidly boiling water for about five minutes. (Do not allow steam to condense on your cotton.)

A gentle hand-teasing of the lint will remove snarls, knots and foreign matter. Carding may now commence and spinning will follow. After decompressing and teasing, you can charge your cards lightly with a thin web of lint. If using wool cards, card and recard several times. Whichever type of cards you use, be sure to turn the carded batt over before recarding to remove knots and lumps. A finer, smoother yarn will result from a well carded rolag and your spinning process will be easier. So take care in this step of fiber preparation. Once you have decided that you are a cotton spinner, you will surely want to invest in a pair of cotton carders. These carders have finer and more closely spaced carding teeth to accommodate the shorter, finer staple of cotton.

## SLIVER COTTON (pronounced sly-ver)

Advanced technological mill machinery has transformed a disarray of compacted cotton lint into a

carded, combed and straightened thin web of fibers which is then drawn through a funnel-shaped device and molded into a soft, rope-like strand called sliver. This coarse strand of parallel fibers is held together by friction rather than twist. Since all short snarls, knots and trash have been removed and each fiber is aligned into a continuous strand, this highly processed cotton sliver allows you to spin a soft and even yarn quickly and easily. Sliver cotton is ideal for production spinning and for designing novelty yarns.

## PUNIS

Throughout the streets of old India one could hear the call of early morning vendors proclaiming their wares, "Punis . . . punis . . . punis . . ." These tightly wound rolags are well adapted to cotton spinning, although they contradict all that is taught about not squeezing cotton and being careful to decompress it. You can easily make your own punis or buy them by the bundle. To make your own, lightly card the cotton lint as usual, but instead of removing the lint in a rolled piece, lift it from the carders as a flat sheet. Lay the sheet of carded cotton on a flat surface and roll the lint around a coat hanger wire. Use a firm, steady rolling motion to wrap the lint around the wire. Once all loose ends are around the wire, push it off from one end much the way you push a wrapper off a straw. You will now have a neat firm rolag with a hole in the center, ready for you to spin into a smooth, even cotton yarn.

## SPINNING PRINCIPLES

Keep in mind that cotton fibers are shorter than most fibers you are probably accustomed to and work accordingly. The single most important factor to keep in mind when spinning cotton is that cotton needs a lot (I repeat a lot!) of twists to hold it together for strength and durability. You will be far better off to overtwist your first attempts at cotton spinning rather than neglect to add the needed twist and have your cotton yarn pull apart as

you wind it off the bobbin. You will know that you have added the minimum amount of twist when the yarn you are spinning doesn't extend as you pull hard on it.

Cotton fibers are slender, single-celled hairs that grow out from certain epidermal cells of the cottonseed. By the time the seed attains its full length, so have the cotton hairs. Thickening of these cylindrical cells continues by the addition of two spiral rings each day on the inner surface of the cell wall. On drying out, these cylinders collapse and become more or less flattened and twisted (convoluted) with the opening of the boll. It is this convolution of the fiber that helps you to spin cotton fibers into cotton yarn.

Due to the lack of the "biting barbs" that we find in wool fibers and to cotton's relatively short staple length, we must depend on extra twist to hold these fibers together as a yarn. Once you have spun a length of yarn you will want to hold it out and allow added twist to build up before winding it onto your bobbin.

As with all other fibers, you can easily spin a length of yarn by twisting the fiber in one hand while pulling back to attenuate the length with the other hand. So too with cotton, you can get "the feel" of spinning by twisting some lint in your hand without the use of a spindle or wheel.

Cotton spindle-spinning is best accomplished with a small supported spindle rather than a drop spindle. You can use your drop spindle as a supported spindle for your initial cotton spinning. Simply rest your spindle in a small saucer (so it does not run away from you) on the floor or table. Holding the spindle at a slight angle, spin "off the tip" without the customary looped yarn around the shaft. The lead yarn is simply wound up to the tip of the shaft and spinning proceeds much the same as on a great wheel.

Inexpensive supported spindles



Handspun cotton by Norma Ajeman

- 1. Brown cotton lint
- 2. Brown cotton, carded rolag
- 3. Brown cotton, ginned cotton; required extra careful carding to produce a fine yarn without slubs
- 4. Brown cotton; single ply. Darker shade achieved by handpicking of the cotton plant and also removing seed by hand
- 5. Brown cotton; minimal amount of hand carding gave this yarn the subtle shading
- 18. Crocheted swatch using graduated shades of cotton. The white is 2 plies of pima cotton. The brown is 2 plies of brown cotton. The shades in between were achieved by blending through carding of both brown and pima cotton.

- 6. Pima cotton lint
- 7. Pima cotton, carded rolag
- 8. Pima cotton sliver
- 9. Single ply using sliver
- 10. 2 skeins of sliver 2-ply; difference achieved through more twist in fiber. Fluffier yarn has less twist
- 11. Sliver; 4 separate singles were spun, then 2 sets of ply were spun, then the 2 plies were plied into a 4-ply yarn
- 12. Pima cotton; 2-ply

- 13. Pima and brown cotton; carded rolag using 75% pima and 25% brown cotton
- 14. Pima and brown cotton carded rolag using equal amount of each
- 15. 2 ply using 1 strand of brown cotton and 1 strand of the 50% pima and 50% brown cotton rolags
- 16. 2 ply using 1 strand of sliver and 1 strand of brown
- 17. 2 ply cotton using 1 strand pima cotton and 1 strand of the 75% pima and 25% brown rolag

designed exclusively for cotton spinning are readily available. The small, well-balanced whorl spins and spins and keeps on spinning, adding the needed twist to your cotton yarn.

Most traditional spinning wheels are easily adapted to cotton spinning. Bulk-head or Indian Spinners are not well suited for spinning cotton. Loosen both the tension and, if applicable, the draw-in to the very loosest possible position. As you begin to spin you can tighten the tension to adjust to your spinning comfort. This looser tension and gentler draw-in of the fiber is essential to cotton spinning. The characteristic short-staple of even the longest cotton fibers necessitates this minimal tension and slow draw-in of your cotton yarn. Do not allow your cotton yarn to "run away" from you into the bobbin as you spin. Control is essential. To add needed twist you can hold the attenuated yarn and continue treading for an additional few seconds before allowing the yarn to wind onto the bobbin.

## SPINNING HOW-TO

Upland cotton spins best if lightly carded into a rolag. This will give you a continuous source of the short fibers. Making the connection of fiber to lead yarn is usually the most difficult process for beginning cotton spinners. You must rely here on the twist rather than the typical "barbs" of wool to make this attachment. Allow twist to build up in the lead yarn, overlap

lead onto cotton fibers and slowly move fiber source hand back, allowing twist from lead yarn to move into fiber mass. Keep your hold on the fibers loose so that fibers will easily flow from your hand. Once the fiber is attached to the lead, use the short-draw method of spinning. Work slowly, inching the fiber-source hand back as you feed more fibers into the yarn. Allow sufficient amount of twist to enter the yarn before feeding it onto the bobbin. By keeping the draw-in loose on your wheel and working in a slow, rhythmical motion you can master short-staple cotton spinning.

Long-staple cotton can be spun using either the long- or short-draw method. The longer cotton staple (1¼" to 2+"") overlap each other allowing for long-draw spinning. Once the fiber is attached to the lead yarn (see above) continue to pull back with fiber-source hand, attenuating the fiber. Allow just enough twist to enter a length (12-18 inches) of cotton fiber to hold it together but not so much that you cannot continue to lengthen it as you pull back. Once you have a length of yarn partially spun continue to pull it out, adding twist intermittently. You can control the amount of twist you allow to enter your fiber length by pinching the fingers of the hand closest to the orifice on the yarn, thus holding the twist back. When you are pinching the yarn with your forward hand you can easily pull your fiber source hand back, elongating the

length and pulling out slubs. Release the pinch on the yarn when you want to add twist to the fiber length. Continue to pinch, pull back, add twist. You will be very surprised to see the lumps and slubs pull out as you extend the length of yarn. Do not be reluctant to pull back with a strong motion. When there is a sufficient amount of twist in the length it will not break or pull apart. There is a very fine line between adding too much twist to the first step of attenuating (which results in not being able to extend the length of fiber further) and not adding enough twist so that your yarn pulls apart. Remember to add a sufficient amount of twist to your cotton yarn before feeding it onto the bobbin. You can use the fingers of your forward hand to smooth and condense the fibers of your spun yarn as you feed it onto the bobbin. Once you have discovered the fine line of adding just the right amount of twist with each attenuation you will spin a smooth and even cotton yarn from long-staple Pima cotton.

Sliver cotton has a distinct directional alignment of the fibers. Run your hand up and down the length of a piece of sliver and you will find that it is much like smoothing the back of a cat. Once you have determined the forward direction of the sliver spin it so that your hand pulling back on the fibers "smooths down the cat's coat". Split the length of sliver down the middle and work with a length about one-half inch thick. A short- or long-



## SPRING '84

### RAG RUGS PUTTIN' ON THE RITZ

Guest Instructor Joanne Tallarovic.  
Create new and exciting looks in this ancient style of rug weaving.  
February 27 thru March 1, 1984.  
Fee \$150.

### TAPESTRY ODYSSEY

Winston Herbert: featured instructor at Convergence 1984. Learn this master craftsman's own loom design and warping techniques.  
March 26 thru 30, 1984. Fee \$150.

For additional information and registration data, please write:  
**Santa Fe Center for Fiber Arts, Inc.,**  
1201 Cerrillos Road, Suite #7, Santa Fe, NM 87502 or call (505) 983-1168

draw method of spinning can be used on these slick and slippery carded and combed cotton fibers. Your resulting yarn will be more regular and even than using unprocessed cotton fibers. There are no slubs or irregularities to have to work out and thus your spinning can proceed more quickly and with less effort. Don't be fooled, however, by the ease of spinning and forget to add the needed twist to your cotton yarn.

Brown cotton, if properly carded, can produce a fairly smooth and even yarn. Due to brown cotton's very short and coarse fibers it is necessary to card and recard several times. You may want to mix some Pima cotton in with your initial attempts at spinning brown cotton to add extra body and fiber length to the fiber mass.

Punis, a luxury item to cotton spinners, can be spun by the short- or long-draw spinning method. Free of lumps and snarls these little rolags spin wonderfully on supported spindles and especially on the Indian charka spinning wheels.

## DESIGNING COTTON YARNS

Once you have mastered the basic techniques of cotton spinning you will want to go on to designing unique novelty yarns for your specific handmade projects. After you have spun each of the above fibers separately and know them as individuals, try mixing them in a medley of combinations. A wide range

of yarns can be created with a combination of cotton fibers. For earthy luxury, try blending and mixing a touch of brown cotton to your carding preparation or ply a creamy-white Pima yarn with an amber-brown yarn for shadows and depth or a combination of both. For heavenly softness of cotton cloud puffs, ply a loose, gently spun Pima fiber yarn with a thinner more tightly spun binder yarn of sliver cotton. That's enough for starters. Let your mind float on the wind and create your own cotton creation.

Cotton is strong and durable and washes well in hot or cold water. Yet it is important to design your cotton handspun to best meet its excellent wearing potential. Your handspun cotton yarn should be designed to meet the needs of your finished project. If a thick yarn is desired, spin several finer cotton yarns and ply three, four or five strands together for added strength and durability. A finer more tightly spun yarn plied together will outlast a heavy, loosely spun cotton yarn in clothing and home furnishings. For greater absorbancy, keep the cotton handspun soft and light. When plying, avoid creating too tight a twist in the yarn. For knitting and crochet projects rely on an evenly spun, moderately tight, twisted plied yarn.

Your cotton yarns can be pre-shrunk by washing the skeins in very hot water one or two times. Block your cotton handspun on a

yarn blocker or by hanging a small weight on the bottom of the skein as it dries. This is a final finishing process that is essential for quality results in your handmade project. With care and forethought you can create beautifully exciting cotton yarns for all your cotton handmade creations.

Cotton spinning may not appeal to you after your initial attempts. You may love to wear cotton and love to feel its soft gentleness in your hand but may find the needed skill for spinning this short-staple fiber beyond you. Do not give up. Consider the challenge and step into it with fortitude. Do not, however, grit your teeth and bear it. Discover the joys of cotton spinning by slowing learning the personality of cotton, its whims and quirks, its beauty and grace. Once you develop your cotton spinning skills you will be surprised at how wonderful cotton spinning really is. You will realize once and for all that it is time to pull the wool off from over your eyes and to enjoy cotton spinning. And who knows, you just may find yourself counting soft, fluffy cotton bolls as you fall off to sleep and dream of wearing 100% cotton handspun handmades!!

*ABOUT THE AUTHORS: Norma Ajeman is a self-taught exotic fiber spinner and a recently converted "all cotton weaver." She markets her handspun yarns to fashion knitters and weavers.*

*Irene Laughing Cloud Schmoller is an avid cotton lover who wears nothing but cotton from head to toe. She is the designer of a "Learn to Spin Cotton Kit" and co-owner of Cotton Clouds—a mail order business specializing in cotton supplies.*

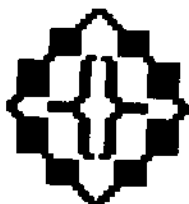

*The Weaver's Loft*

for your weaving and spinning needs.

• Schacht • Norwood • Harrisville •

Unique fashion threads for knitting and crochet

Rag Rugs \$40 per inch

Open Monday-Saturday 11-5

(815) 786-2233

215 West Center, Sandwich, IL, 60548

Full color range of Berga yarns  
"Swedish wool spinners since 1856"

Wool, alpaca, cotton, linen blends

Ten sample cards: \$10

22 to 130 colors/card

MAIL ORDER

**Caryl Gertenrich**

459 High S.E.

Salem, Oregon 97301

(503) 363-9665



## A NEW DIRECTION

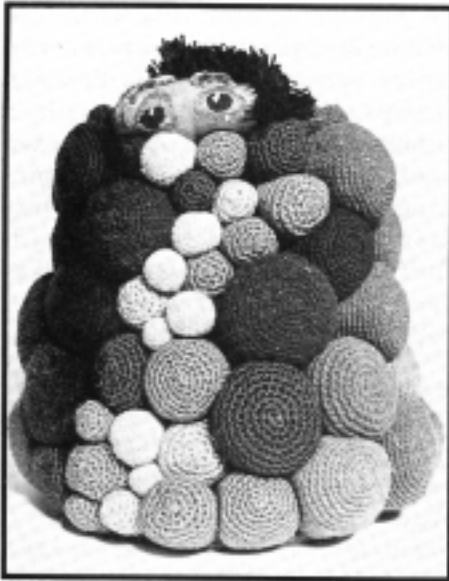

*"Ball Basket" by Sharon La Pierre; crochet and tapestry.*

Kent Johnson

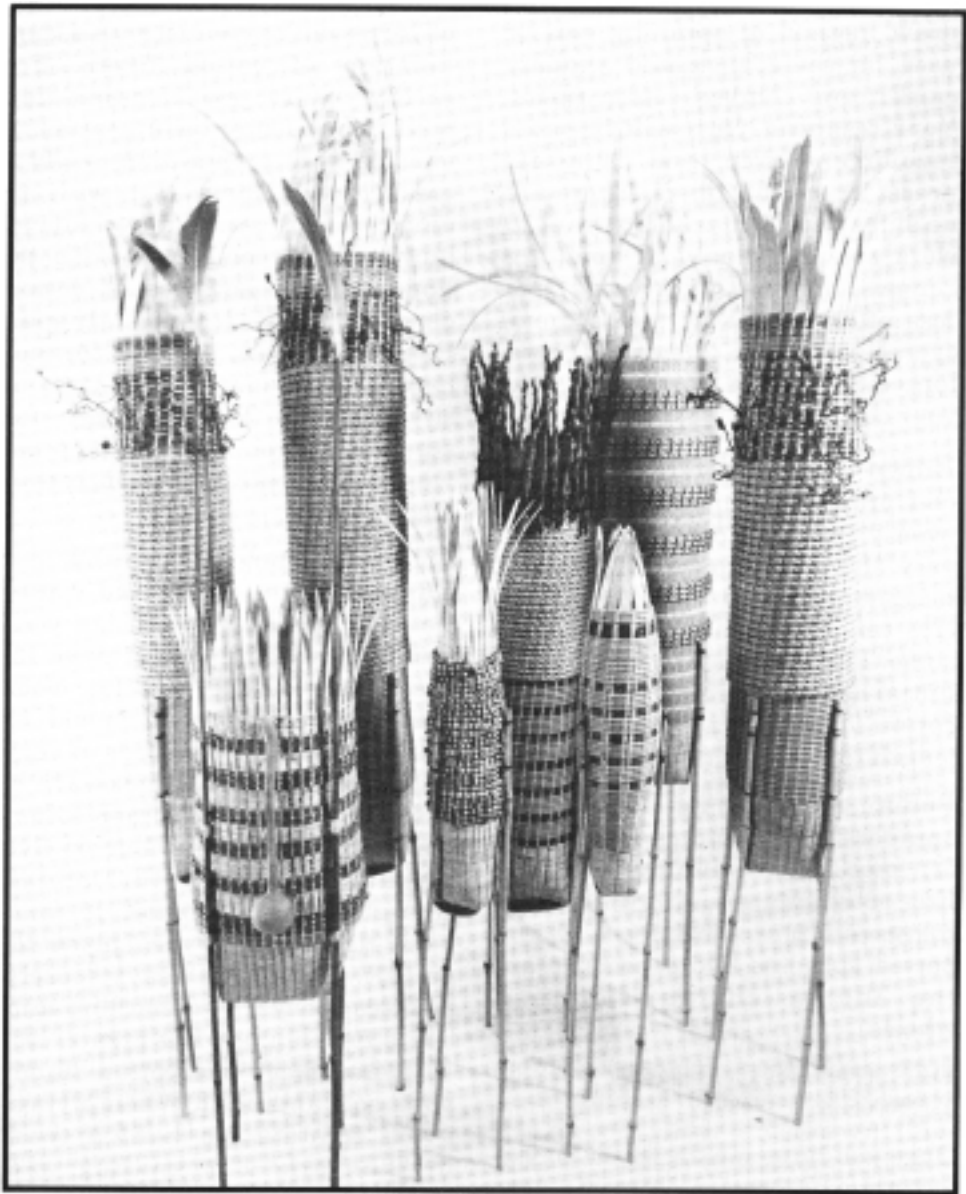

Douglas Fuchs

*"Forest Group" by Douglas Fuchs; 6' tall, flat reed, raffia, vine, rolled paper, alanthus branches, grapevine, manila rope, bamboo, waxed linen and bark.*

Basket making is one of the oldest crafts known to civilization. In the past its purpose was mostly utilitarian, to make containers for carrying water and to cook and store food. These functional constructions were essential to survival and expressed the lifestyle of the users by the various designs imposed upon the surfaces. Baskets were artistic products to be used and reused, to perform functions intended by the maker. Art and craft were not separated; the craft was the method by which to pro-

duce an artistically creative implement.

The natural materials used for construction were dictated by the geographical location, and man explored the uses of the materials of his immediate surroundings. There were three basic techniques used: plaiting, coiling, and twining.

As mankind has moved forward in time, there is no longer a need to produce functional baskets—technology has met these needs in modern society. Consequently, a

new breed of craftsman has evolved—a maker of baskets for art's sake. Traditional basket techniques and methods are still being used. But the main emphasis is on form and its aesthetic qualities or on exploration and the joy of creating solely to develop an idea. Constructing and building an object to give pleasure to the viewer, as well as to the maker, is perhaps the most important element of present day basket making. This element of deriving pleasure from beauty is what makes art, and it



*"The Cat House" by Maxine Kirmeyer; twined of hemp, coir, date fruit stalks and palm twigs.*

## FOR THE ART OF BASKETRY

by  
**Sharon La Pierre**

seems the purpose of art is to encourage others to live by experiencing the inspiration of the artist through his/her creations.

Craft seems only to be separated from art because of its concern for usefulness, not because of beauty, and this separation is a product of the Industrial Revolution. Being an artist and a craftsman once implied the same thing because the product was based on quality and inventiveness to perform a particular function. Now, if the product

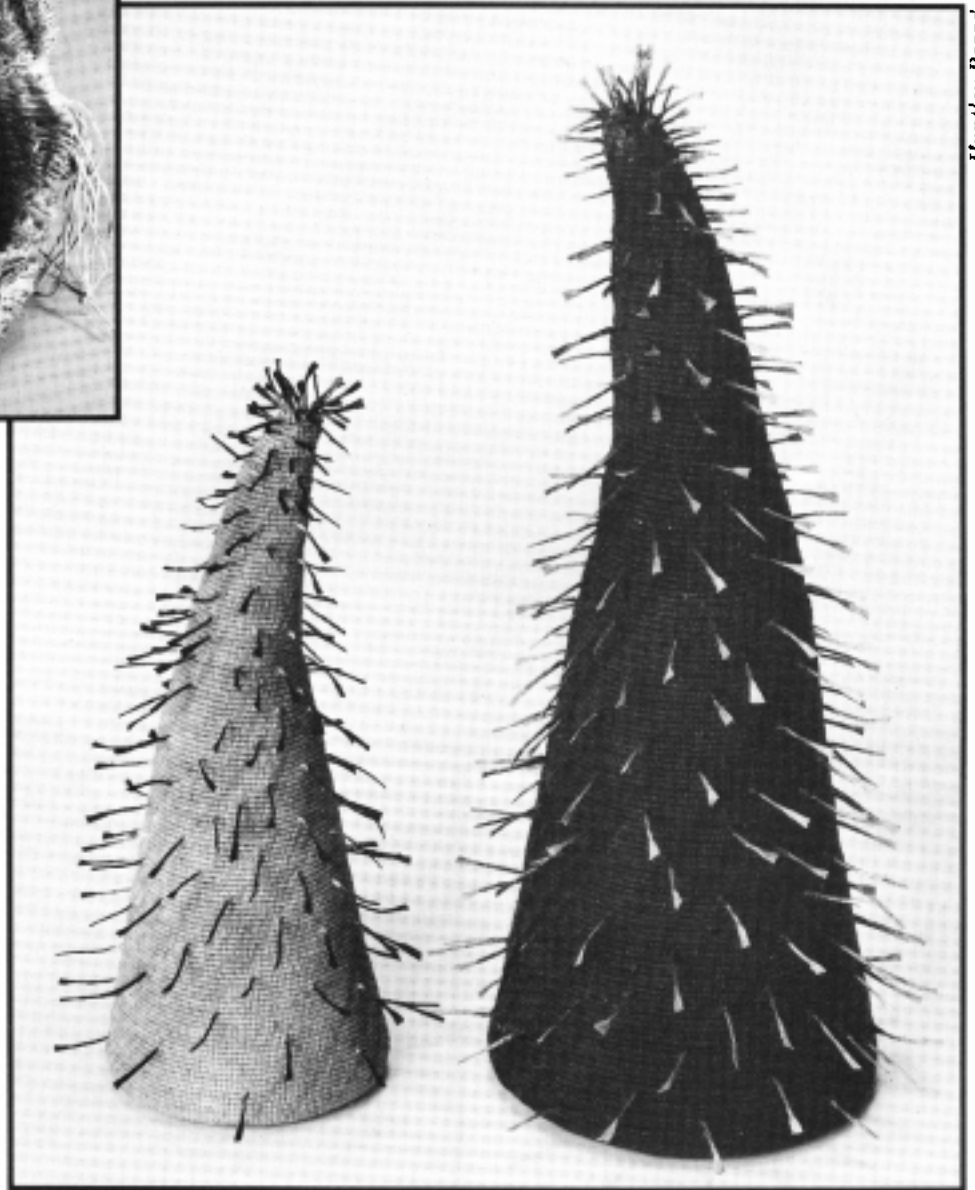

*"Relationship I" by Jane Sauer; 8½" and 11½" tall, knotted waxed linen and paint.*

is based on "uselessness," it is considered art—useless in the sense that the purpose is only to produce objects that are decorative. However, no painter could produce without the knowledge of his craft to mix paints, to stretch canvas, or to develop an idea that is pleasing to his/her audience. The idea that craft vs. art is not a new one. What is new is that basketry, a categorized craft, is attempting to be sculpture or to appear on the art scene as something other than a product of functional technique.

Let me define the term "basket," according to Webster's *New Collegiate Dictionary*, it is "... a receptacle made of interwoven material." The word "container" is also defined as a receptacle. Basically, a basket is considered some sort of receptacle or vessel form. In the past, tradition and need dictated the basket maker's style and development of shape. Now, however, the artist (the basket maker, the craftsman) is dictating what basketry can do and how it can be expressed. The freedom to individ-



Kent Johnson

"Jester Basket" by Sharon La Pierre; 14" tall, tapestry, coiling and crochet.

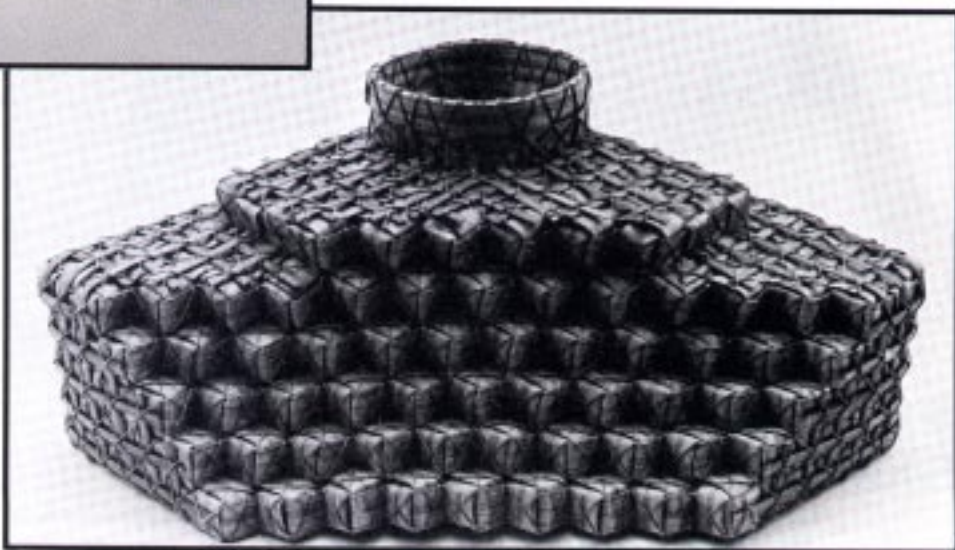

Shereen LaPlantz

Basket by Shereen La Plantz: plaited, knotted and sewn.

ualize basket style, by designing and using materials to suit the maker, has become a product of our time.

The reasons behind making baskets are as numerous and varied as the individuals making them, although I believe that most artists are propelled by an insatiable desire to do and to create. There are many exciting techniques, materials, and subjects now being used. These unique and varied expressions are what the art

world should enforce, but I do not believe that it yet does. Because basketry has been considered a purposeful craft for such a long time, connoting the use of natural materials and the vessel look, expectations are predetermined by the viewer, the art critic, the museums, and the galleries. Baskets need to be observed as art, as form bringing joy to the viewer. Some basket makers are beginning to force their audience to observe their creations in this manner by creating wonderfully sculptural or

intricate pieces that impel the sense to look, not use. Artists are creating basket forms from clay—an idea not to far removed from the traditional use of clay in Oriental forms. Some artists are combining techniques and media, using stuffed fabric, crochet, knitting, or macrame to develop their ideas. The techniques have been altered and expanded so that the treatment of the basket subject has become so unusual that the terms "basket" and "container" are only titles, loosely expressing the inten-



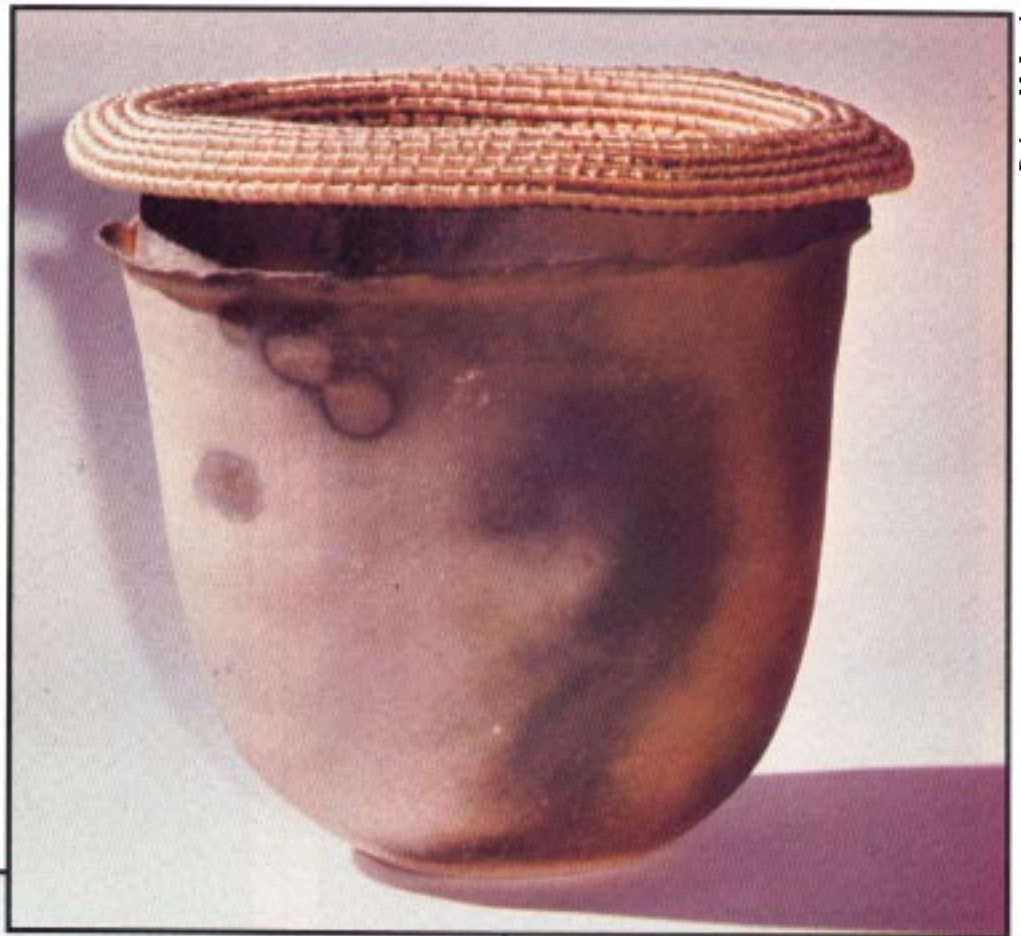

"Star Basket II" by Diane Totten-Sais; 13" tall, terra cotta, coiling and stuffed satin.

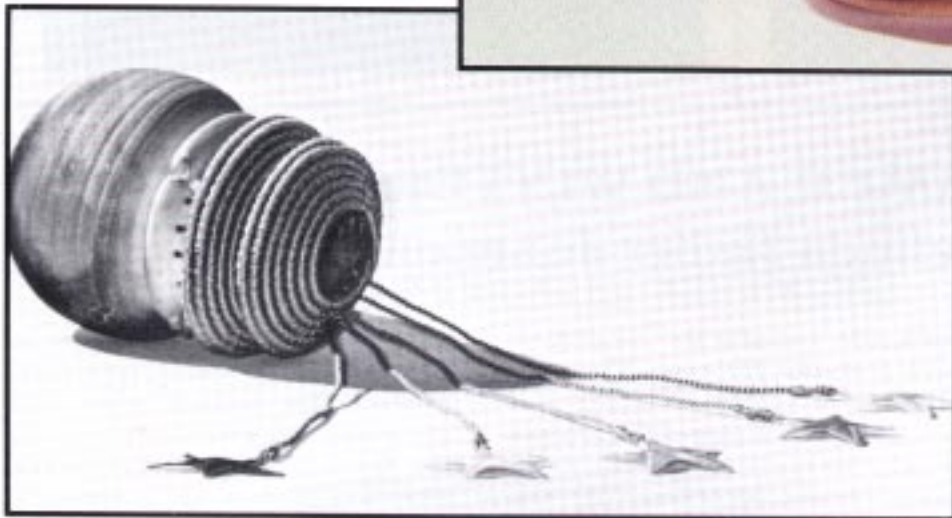

"Comet III" by Diane Totten-Sais; terra cotta, coiling and stuffed satin.

Robert McLeod

tion of the piece.

Is basketry really sculpture? Yes, I believe it is sculpture and it can be either utilitarian or only aesthetic. Basketry is just beginning to claim its place as an art form along with all the other crafts. It has always been an art form. It is just that modern society is being coerced into regarding excellence and quality of utilitarian subject matter (basic craft philosophies) as legitimate vehicles of art expression.

*ABOUT THE AUTHOR:* Sharon La Pierre is a fiber designer and art educator. She holds a B.A. from California State University, San Jose, in design and music and an M.A. from California State University, San Diego, in weaving. She has taught at the college level for the past thirteen years. Her fiber designs have appeared in major U.S. shows and in many books, where she has gained a reputation for her fantasy, soft-sculptural basketry. She is presently the director of the gallery for a community college and president of Genre Communications, Ltd., a publishing house devoted to developing educational materials. Her book, *YOU CAN DESIGN, AN ADVENTURE IN CREATING*, was published in 1983. In addition, Ms. La Pierre is nationally recognized for her workshops and lectures on

design and creativity. She is a design affiliate member of the American Society of Interior Designers (ASID). ■

Red Rocks Community College Art Department of Golden, Colorado, will be hosting a basket conference in August 1985. Its purpose will be to bring basket makers together for discussions and workshops. Participation will be limited. If you would like to be placed on the mailing list, contact Sharon La Pierre, Red Rocks Community College, 12600 W. 6th Avenue, Golden, CO 80401 (303) 988-6160, Ext. 268. ■



## TURNED SUMMER AND WINTER JACKET by Melinda Raber Johnson

The idea for this garment sprang from a study group of the Indiana Weaver's Guild on Summer and Winter weave. As we went through the possible variations of the traditional method, "Turned Summer and Winter" caught my eye. Since I had just bought a (used) 12 shaft loom with two back beams, I decided that I had to try this "quick" way to weave Summer and Winter patterns in which the pattern is produced by a supplementary warp rather than a supplementary weft.

I made some small samples to try different sizes and types of yarn and settled on Crown Colony Wool (2 ply) from Henry's Attic. I dyed enough yarn for the blue pattern warp and then sat down with pad and pencil to pick out a 5 block design. Turned Summer and Win-

ter needs 2 shafts for the ground and 2 shafts for each block: 12 shafts = 5 blocks, 8 shafts = 3 blocks, etc. This step of the process was by far the most difficult. After many hours of filling in the squares, I finally picked a favorite arrangement of blocks and figured out the threading. As in any block threading, the treading sequence of the blocks can be decided during the weaving, so I had many design possibilities included in my chosen threading.

After the long period of time it took to decide on the threading and treading and to warp the loom, the actual weaving time was only about one hour (since the pattern yarn is in the warp, only one shuttle is used during weaving). I removed the woven cloth from the loom, washed it in luke warm water

and soap on a gentle cycle in the washing machine and then brushed the surface while the fabric was still wet. The fabric was laid flat to dry. The fabric for the hood was woven on a separate warp in the traditional Summer and Winter method with 2 blocks on a 4 shaft loom. It was then washed and brushed in the same manner as the body of the jacket.

The sewing pattern is one that I developed following the style of a ski vest. The only cutting to be done is the armhole slits and a slight sloping of the shoulder line. The shoulder seams are sewn and the hood fabric is folded and seamed and attached to the neck edge with a narrow seam, matching the block stripes. The turned-under center front edge of the body and hood and all seams are then

covered with a one-inch wide strip of a knit binding (knit on a knitting machine—a great time saver!). The armholes and bottom edge are covered by a folded band of ribbing. This makes the jacket reversible.

After the garment was finished, I decided that I needed something to wear with it. I went back to the knitting machine and knit a turtleneck sweater using the same yarn, adding a blue pattern on the sleeves and across the upper bodice. Before the sweater was assembled, each piece was washed, brushed and then pinned to shape to dry.

After about 20 hours of actual work and untold hours of designing, the final outfit was shown in the Midwest Weaver's Conference fashion show at Berea, Ohio, and won 2nd place in the Sportswear category. It was a thrill and an honor that I will remember for a long time to come.

Fig. 1 shows the threading for each block of turned Summer and Winter, giving a paired brick pattern. The plain weave ground shafts 1 and 2 carry the background yarn (natural wool) and the pattern shafts 3 thru 12 carry the blue pattern yarn. When threading blocks in ascending order (A-B-C), just thread the blocks as listed. However, when the blocks change directions (C-D-C or C-B-C), you must repeat the first 4 threads of the center block before continuing in order to balance the pattern. When threading blocks in descending order (C-B-A), switch the first 4 threads with the last 4 threads of each block. See Figs. 2a & b.

The treading sequence for this threading is:

- 1 + both shafts of the blocks desired
- 2 + the odd numbered pattern shaft (2 3 5 6 8 11) = pick a
- 1 + both shafts of the blocks desired
- 2 + the even numbered pattern shafts (2 4 6 8 10 12) = pick b

To weave no blocks, treadle:

- 1
- pick a
- 1
- pick b

To weave block A, treadle:

- 1 34
- pick a
- 1 34
- pick b

To weave block B, treadle:

- 1 56
- pick a
- 1 56
- pick b

To weave blocks B & C, treadle:

- 1 5678
- pick a
- 1 5678
- pick b

To weave blocks C & D, treadle:

- 1 78910
- pick a
- 1 78910
- pick b

To weave blocks B, C & D, treadle:

- 1 5678910
- pick a
- 1 5678910
- pick b

To weave block D, treadle:

- 1 910
- pick a
- 1 910
- pick b

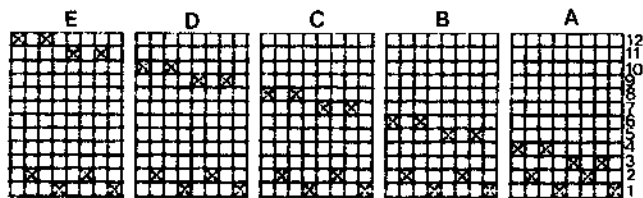

FIGURE 1

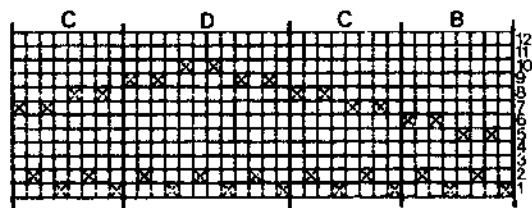

FIGURE 2a

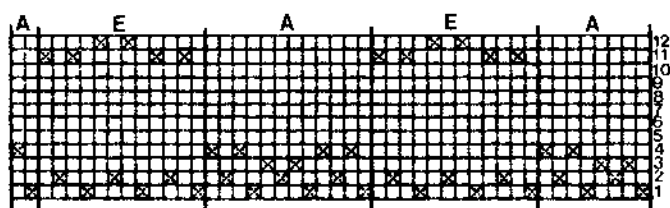

FIGURE 2b

## BODY OF JACKET

**Warp:** 100% Crown Colony Wool (2 ply) (from Henry's Attic). The background is natural color, the pattern yarn is dyed to a navy blue with fiber reactive dye. The pattern yarn is warped on a separate beam from the background.

**Weft:** Same as warp except in a fawn color.

**Width in reed:** 30" (76.2 cm)

**Total number of warp ends:** 360 (180 natural and 180 blue)

**Sett:** 6 dent reed (25/10), one natural and one blue in each dent

**Finished length woven on loom:** 60" (152.4 cm)

**Threading and treading:** See Figs. 1, 2 & 3.

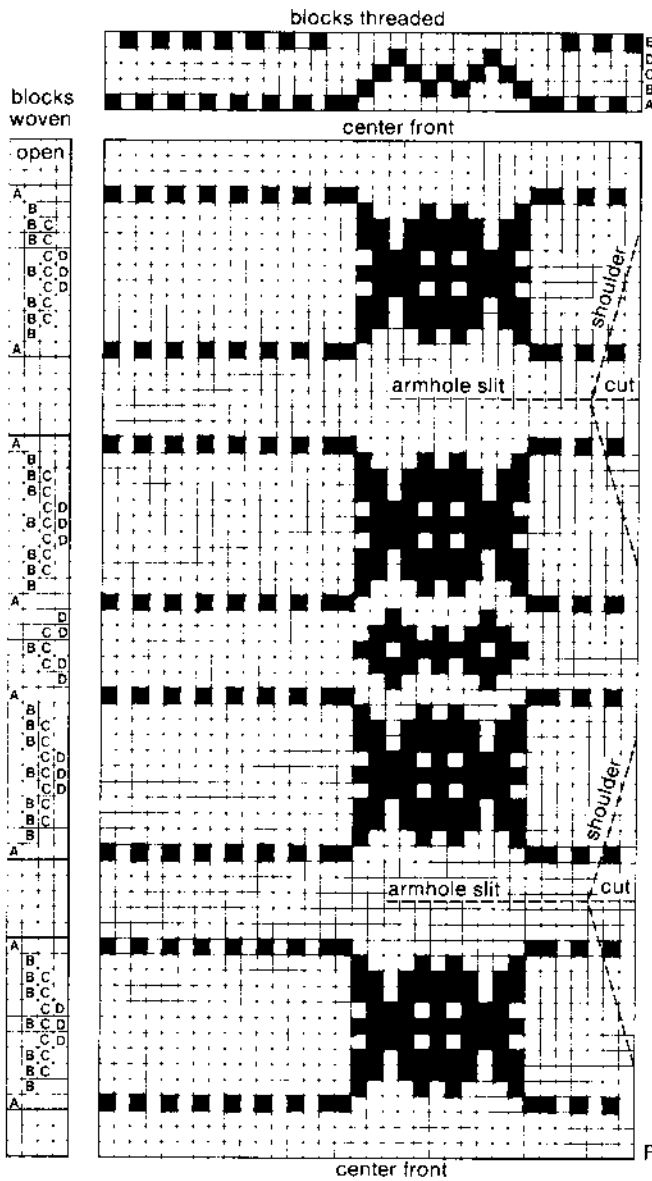

FIGURE 3 JACKET BODY

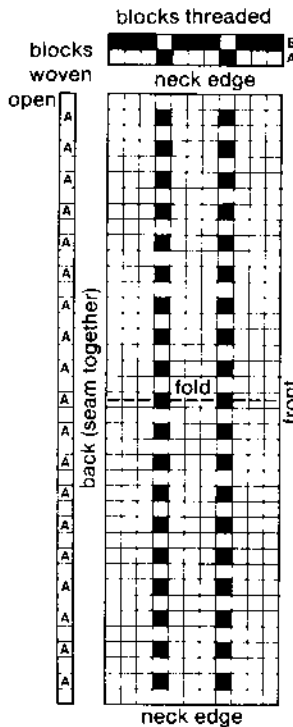

FIGURE 5 HOOD

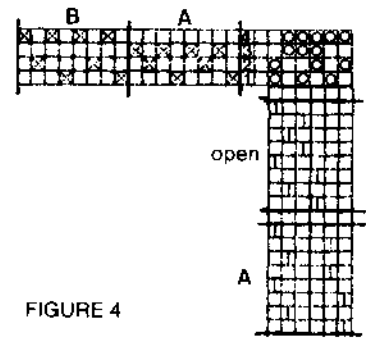

FIGURE 4

### HOOD

The hood is woven separately on 4 shafts as a two block design in regular Summer and Winter.

**Warp:** Same as body weft, sett at 6 epi

**Weft:** same as body warp. There is a ground weft and a supplementary pattern weft.

**Threading and treadling:** See Figs. 4 & 5.

**FINISHED CLOTH DIMENSIONS** (before sewing):

**Body:** 27" by 50"

**Hood:** 11" by 32"

## A NEW JOURNAL FOR CREATIVE TEXTILES



In the Federal Republic of Germany an association with a journal is being founded as a forum for all those who are interested in creative textiles. Its members belong to the various fields of textile activities, as there are textile art, design, craft, adult education, teaching in schools, trade with textile art and materials. The development in some of these spheres has grown rather quickly during the last years, the necessity for more information—also from over the German borders—became more and more apparent.

Our main point will be the supply of information and the promotion of contacts and interchanges among persons interested in textile art. Further we wish to reflect on tendencies and enforce trend discussions regarding the development; at last, presentations and portraits of individuals from the textile scene are planned. The DEUTSCHES TEXTILFORUM should be a working medium and a "round-about" for references and contacts!

**Textilforum**  
**Postfach 5944**  
**3000 Hannover**  
**West-Germany**

**loom REEDS**  
 QUALITY REEDS FOR  
 OVER 50 YEARS

Made to your specifications, carbon or stainless steel, any dents per inch, lengths and widths. (Metric Reeds also available.)

Write For price list:  
**BRADSHAW MANUFACTURING CO.**  
 P.O. Box 5645  
 West Columbia, S.C. 29171-5645  
 (803) 794-1151

---

---

# LOOMING THOUGHTS

by Allen A. Fannin

---

---

*"Unless survival of one's . . . business is of principle importance, . . . failure is assured."*

---

---

In recent months we have had the occasion of seeing several struggling, would-be handloom weavers and handspinners leaving the business, having reached a plateau of growth from which they were unable to continue. This happening, one we have observed first hand for more than fifteen years and second hand for nearly twice that time, often occurs after the weaver/spinner has laboured with what could only be described as an heroic struggle against odds that all but guarantee self-defeat.

Though some of its editorial predictions may be cause for faulting the magazine, the old *Handweaver and Craftsman* still remains the only primary documentation of what handloom weaving was in America from a period just after WW II until publication ceased in the early 1970's. It has always been a curious exercise for us to peruse that periodical and to read of "successful" handloom weavers, in business for a short time, in lengthy articles replete with double page picture spreads, only to scan the classified ads two or five years subsequent to the success story, and find that enterprise dispersing all its equipment and leaving the field entirely. While small business failure is high in any field, we are particularly suspicious about handloom weaving, not so much because of the failure, but because of the question that could be raised as to whether those who leave the field were ever really fully in business in the first place.

Handloom weaving as the only means of woven cloth production was at its peak both technologically and sociologically during the period just prior to the beginnings of the Industrial Revolution in Great Britain. Of special note to

our present thesis here are the social class and lifestyle of those early handloom weavers as compared to the would-be weavers of the present day. His bigotry notwithstanding, Archie Bunker might put it, ". . . you knew who you were then. . ." in the early days of pre-Industrial handloom weaving. Granted the evils of the British class system, the definition of who was and who was not a weaver was unequivocally clear. A weaver was simply anyone who depended upon the output of his/her hands for his/her livelihood. There was a direct relationship between income and output. A weaver did weaving. A weaver was not one employed in some weaving related activity. It was the total dependence of the weaver upon his manual skill and output that was the key distinction between today and then. Writers such as Bischoff in his *Comprehensive History of the Woollen and Worsted Manufactures* and James in his *History of the Worsted Manufactures in England from the Earliest Times* well document this crucial point. Unfortunately, modern language and thinking are not as exact and critically clear as they once were. We find that most modern weavers begin with an intellectual interest in handloom weaving and so thus cloud the idea of being a weaver in the first place with the purely academic notion that mere knowledge of, and interest in this activity alone, make one a weaver by definition. With no clear insight, with few role models and with conflicting pressures to be or not to be this or that, one cannot fault those who enter the field with less than the single mindedness of purpose once pursued in earlier times.

The attraction of the field, while it is lessening, is nonetheless there,

holding on to those who have made a commitment, however tentative, and who have not yet suffered the failure toward which so many are aimed. A friend who is a writer of great means once compared the attraction that fields such as handloom weaving hold out with the attraction that farming once held for so many. Only now is the truth of the difficulties of an agricultural business directly connected to food production becoming more widely told and this probably because so many are leaving farming that the truth defies concealment. The history of American society is very much tied together with the foolish relationship between money and brains. (If you're so smart, how come you ain't rich?). Therefore to admit that one's endeavors do not yield as great a return monetarily as one would have one's peers believe is more than tantamount to admitting utter stupidity. In this light we find so much more time spent dwelling on "success" that many unforgivably neglect to recognize potential of real failure, far less learn from it. It was and still is a source of rare positive amazement to this writer to have once seen in a weaving periodical equal space given, and timely so, to both the success of a major hand textile production enterprise and in a follow-up article, its rapid demise. Confronted with and confounded by so much "success", the attraction of handloom weaving as a livelihood is only half real and in no way prepares new entrants or even those with some mileage in the field to make the kind of rational choices that might, over the long term, prove successful.

There are some significant realities about being a handloom weaver in the old sense as it relates to the practice of that trade today

which we must explore. Unless the survival of one's enterprise as an economically viable business is of principle importance, of first priority, failure is assured. It behooves us to examine with great concern a motivation that is nearly completely generated from a "love of weaving" with little or no attention paid to how that love will be manifest as marketable realities. One may be in a state of profound dedication to weaving a scarf that will retail at \$60 but the market may be so limited as to make survival on that basis alone certainly tenuous. A great many people enter the field and unfortunately nearly as many leave the field who believe their own "thing" to be shared by a wider public than is in fact the case.

At a lecture we presented some years ago, we were asked why we practise the weaving trade in the manner we do. Succinctly, our reply could be stated thus: We do enjoy practicing the skill of weaving. So strong is that enjoyment that we wish to work at weaving as much as time and life will allow. In recognition of the economies of the world, we must somehow have an income that will permit us to live in the bare minimum lifestyle to which we have been willing to become accustomed. Therefore, we are faced with two basic choices. If we are to practice weaving with no regard for economics, then that income must proceed wholly or partly from some source other than weaving and since we are not independently wealthy, that other source must be our labor which is non-weaving. However, since our desire is to weave as much of our time as possible, we have made the second of our two choices, to wit, to weave in such a manner that our income is produced by that which we most want to do, regardless of the manner in which we must do it. Given the social and academic background of most handloom weavers today, it would be a rare occurrence indeed for some one to approach weaving in a manner that would yield a product of suffi-

cient appeal, however limited, to permit the weaver to practice weaving at the exclusion of all other work activities and with no subsidiary income. Potters do it, weavers do not. Why, still remains the basic question.

History, near and far past well documents weaving of any kind as a most labor intensive activity, whether done by hand or by power. For nearly two decades, this writer has been mystified at the extent to which weavers persist in defining themselves and what they do in such a manner as to concentrate on the intensity of their labor rather than look for ways to reduce the effort, yet, retain most, if not all, their aesthetic freedom. When one who is not a weaver looks at handloom weaving business both from the point of equipment design and of production routines, the reaction is usually one of amazement that such an approach is able to yield any return worth considering. We have been able to observe many weavers who design items for sale with filling yarns so bulky that a "normal" hand loom shuttle can hold sufficient yarn for only a few seconds weaving before the loom must be stopped for bobbin replacement, causing much lost time. We know of more than one rug weaver who will use stick or ski shuttles rather than add a race plate to their loom and throw a cop shuttle. In other instances, we have seen weavers in major market areas struggling with the burden of massive rent bills for space, inefficiently used at that. We have seen still others whose growth, if not very existence, is threatened by warping equipment that will not permit warps long enough to balance the requirements of incoming orders. Finally, just last week we visited a handloom weaving establishment in which four looms were in operation, yet there were barely sufficient filling bobbins on the premises for one loom, causing each weaver to spend time not weaving, waiting for empty bobbins.

It has long been an argument

offered against even the possibility of pursuing weaving as an economically viable activity that such viability is not possible in the face of competition from the mills. This argument fortunately has no basis in fact and is, we suspect, offered more as an excuse for failure than a reason for it. There are, however rare, successful handloom operations in just about every state wherein the enterprise is, or has the clear potential for, generating an income on which the entrepreneur can live with no outside source of funds. We can only emphasise that for this kind of potential to be realised, the operation must first be founded on the basis that it will be economically viable no matter what has to be done to make it so. In some instances this may involve building special equipment to increase one's efficiency; in another instance it may involve identifying a market that is too small for mill interest yet is sufficiently large for several smaller operations to survive and do very well. On the other hand, if one should enter the business with the idea that one must always have the measure of steadiness and security, offered by working for a major corporation, and so work both as a weaver and in some other way at the same time, facts make it very clear that the weaving enterprise will always suffer first and most. It is important to understand that the basic problem is not handloom weaving itself, for there is nothing intrinsic to it that renders it any less able to provide a full-time income than any other trade. The basic problem is one of self-employment and it is to this problem that most failed and failing handloom weavers resist addressing themselves. In particular, no matter how wonderfully one may evaluate one's product, success still requires that one leave the confines and relative safety of one's premises and go out into the world of commerce and sell. It may be selling directly to the retail consumer; it may be selling to a store buyer or it may be selling to a sales representative who will in turn sell to the store buyer. But, for good

or for bad, the word is selling. Unfortunately, these realities of the world of commerce are not made even remotely clear to most weavers as they enter the field.

One must also realise another aspect of self-employment that is always cause for concern. As a totally self-employed handloom weaver with no paid help, one must wear more hats than could initially be imagined. One must be more than the usual weaver/designer. Even the idea of designer involves more than mystical aesthetic considerations. The background of most handloom weavers does not prepare them for the multiple roles they must assume. Jack Larsen made this point quite clear in reply

to an interviewer's question in a recent issue of this very Journal.

It is interesting to note that most working handloom weavers tend to struggle in relative isolation from one another, each fighting the same battles as the other yet with little being learned from what has gone before. This state of isolation is also a separation from the world of commerce, the world whose rules they may have had little to do with making, but the world whose rules may mean success or failure for us all. We have often speculated on whether it would be beneficial for there to be the kind of association and communication among handloom weavers, both working and would-be working, that exists

among suppliers to the trade. Suppliers to the trade seem to have gathered their forces to an extent that those whom they supply have never even considered.

There are successful handloom weaving operations which can serve as role models, if one in fact needs a role model. The greatest impetus will come from a more clear definition of handloom weaving such that the definition will include practising the trade in a manner that can contribute to economic survival. As always, we remain optimistic since our own survival and that of our children depends on it.

© Allen A. Fannin

**Indigo** Press  
NEW revised edition  
Send \$5.95 to: Indigo Press  
DOROTHY MILLER  
5950 Fern Flat Rd  
Aptos, CA 95003  
Order form for Free indigo seeds in each book

**FIBRE FACTS**  
BY BETTE HOCHBERG  
Weavers guide to fibres and yarns. How to choose and use them; finishing and care. Properties of natural and synthetic fibres; and how they influence quality, appearance, performance of textiles.  
\$5.95 at local stores, or \$6.95 postpaid from:  
STRAW INTO GOLD  
3006 San Pablo Ave., Berkeley, CA 94702

**WILDE YARNS FOR HANDWEAVING**  
All Wool Yarns for Handweaving  
Carded Wools for Handspinning and Felting  
Natural and Dyed Colors  
Send \$3.00 for Sample Cards  
Dealer Inquiries Invited  
**WILDE YARNS®**  
3705 Main St. Dept. W  
Philadelphia, PA 19127  
A Tradition in Spinning Since 1880

Santa Fe Weaver's School  
BOX 9001  
SANTA FE, N.M. 87504  
505-983-8058

WEAVING  
INSTRUCTION  
~~~~~  
BEGINNING  
INTERMEDIATE  
ADVANCED  
~~~~~  
4 HARNES  
LOOMS  
FURNISHED  
~~~~~  
WRITE  
FOR  
BROCHURE

**The LINDEN TREE MARKET PLACE**  
Three shops in one catalog  
\*THE PRINT SHOP printed paper products including the new **SHEEP & FLEECE RECORDS**  
**NATURAL DYE RECORDS**  
\*TREE TREASURES handcrafted wooden items including Christmas ornaments  
\*THE FARM SHOP weaving and spinning supplies  
Colored fleeces available only at the farm.  
Send \$1.00 for catalog, refundable on first order.  
TO: THE LINDEN TREE 491 WJ E. Colburn Rd.  
Free Soil, MI 49411  
**the Linden Tree**

# BOOK REVIEWS

Unless otherwise noted, all book reviews are by Clotilde Barrett.

*HISPANIC COSTUME 1450-1530* by Ruth Matilda Anderson © 1979. The Hispanic Society of America. 28 x 20.5 cm, 303 pp., 569 black and white illustrations, 8 color plates. Available from The Textile Museum, 2320 S. St NW, Washington DC, 20008. \$29, \$26 members. ISBN 87535-126-3.

The complex, ornate and elaborate costume of men and women of the Iberian Peninsula, who lived in a dynamic period of time under the rule of the Catholic Kings through the coronation of Emperor Charles V of the Holy Roman Empire, is beautifully presented by Ms. Anderson, curator of costume at the Hispanic Society of America. Costume is seen as a powerful, visual means of communication signaling wealth, class and outside influences—a non-verbal history of the times.

Some of the major events of this period included the subjugation of the Moors, the discovery of the New World, the conquest of Mexico, and Pizarro's advance against Peru. The lines of the costumes moved from the slender image of the Gothic to the full, rectangular one of the Renaissance. As means of warfare evolved, the armor worn by soldiers was replaced by padding placed next to the body. Slashes in the sleeves became a decorative feature; influences of Italy were seen in broad style shoes, wide shoulders and full sleeves.

For serious students of historic costume and textiles, as well as theater designers and art historians, this thorough, well documented and illustrated book is a valuable reference; for those studying New World costume, the influence of Spain must be considered. Illustrations are drawn from many sources of the period such as choir stalls, paintings, woodcuts, tapestries, prints, retablos, book illustrations, statues and miniatures. The book is well designed. The illustrations presented relate to the adjacent text. Many examples of the same element of clothing such as headgear can be seen at one glance. In addition, Ms. Anderson uses descriptions from documents and literary works of the time to provide what she calls "... dress occasions." In these sections the costumes are placed in an historic context.

Sections on men and women's dress elements are precisely detailed. For the men, categories include hair styles, (handsome luxuriant hair was in fashion and hair pieces and curling irons were in use), facehair (beards but the clergy were required to shave every two weeks), headgear (sombbreroes were introduced in this period as were silk or gold nets and turbans—a sign of Moorish influence), and body garments such as the jerkin, stomacher, paltock, and shirts. Leg coverings are discussed; this category includes hose, martingate, garter, breech hose, upper stocks, and the codpiece that was used for a variety of purposes such as hiding items like letters, oranges and even a roast partridge. Accessories—gloves, tassels, purses, fasteners—are introduced and, finally, outer garments and furs. It is of interest to note that silk, wool, brocade, velvet, satin, and cotton

were all in use.

There is much in this study to interest and inform the reader. One is left with a feeling of admiration for the variety of ornaments employed by the residents of the Iberian Peninsula in their costume.

Margot Schevill

*THE ART OF ARABIAN COSTUME: A SAUDI ARABIAN PROFILE.* By Heather Colyer Ross. © 1981. Arabesque Commercial SA., Fribourg, Switzerland. 31 x 26 cm, 188 pp., 140 color plates, two maps, 10 color illustrations, 43 black and white illustrations. Available through The Textile Museum, 2320 S. St NW, Wash. D.C. 20008. \$50, members \$40. ISBN 0 907513 00 X.

This is a beautifully illustrated survey of Arabian costume, both past and present, written by a woman who knows her subject matter. Mrs. Ross is the author of another book on Bedouin jewelry, a result of living in Riyadh since 1969. The style of writing is flowing, highly readable, and anecdotal, utilizing considerable documentation from outside sources. Written from the perspective of an interior designer, decorator, and fashion connoisseur, the book contains artists' renderings of some of the costumes, done in a "Scherzade" style by Sheila Talbot. Expert black/white drawings of the basic patterns of costumes, done by Mrs. Ross, will be of use to those who wish to recreate Arabian dress. The quality of the colored plates is first class; one could argue with the romantic quality of some of the photographs, placing a non-indigenous model in a flowing chiffon costume, wearing ornately decorated headgear, barefoot on the sand, camels calmly looking on in the background.

The book moves from a section on the historical background of the Arabian peninsula, outlining the trade routes, to a discussion of outside influences on Arabian costume and life coming from the Levant, Mesopotamia, Egypt, China, Persia, India, Central Asia, Asia Minor, Byzantium, Northern Europe, Africa, and finally Islam—the most potent of all.

Traditional Arabian costume for men, women, and children, as well as undergarments, pilgrimage, burial, and mourning attire and footwear are well presented with details about trimmings and accessories. A startling image is that of the face veil or mask. In the traveling show *Traditional Crafts of Saudia Arabia*, organized by the Memorial Art Gallery of the University of Rochester, these masks were on exhibit. One could only imagine how they look on the human body and the implications therein. Mrs. Ross shows the reader. A presentation of body ornaments, including body culture (makeup), and jewelry, leads to a section on arts and crafts. The weaver's interests are not served in this exposition for Mrs. Ross does not describe the loom or techniques used to create these unusual costumes. However, she does describe the fiber technique with which she is familiar. Her background in fashion enhances the first two appendices, dealing with embroidery stitches and Be-

douin dress embroidery. Appendix 3 considers the care of textiles, how to preserve costumes, particularly those that are no longer in use. The glossaries will be of special interest to those involved in Middle Eastern culture. Included is the Arabic script as well as the transliteration.

This is a serious study of what Mrs. Ross calls "a disappearing art." If one can muster up the hefty price, (it is well worth it), it will provide many hours of visual pleasure.

Margot Schevill

*AFRICAN TEXTILES: LOOM, WEAVING AND DESIGN* by John and John Mack Picton. © 1979. Published by British Museum Publications Ltd. 208 pp. 27.5 x 21.5 cm. 208 B/W plates, 28 color plates. \$18.50 Museum Shop, American Museum of Natural History, 79th & Central Park W., NYC 10024. ISBN 0 7141 1553 3.

This is one of the most comprehensive, informative and beautifully illustrated books on the complex subject of Africa textiles available today. The cost is modest, compared with similar publications. It was named *British Craft Book of the Year* in 1979 and was prepared in conjunction with the opening of the exhibition *African Textiles* at London's Museum of Man, on display from December 1979 to January 1983. The presentation at the AMNH represents the first time the British Museum has lent an entire major exhibition to any museum abroad. The authors are responsible for the African collections of the British Museum Department of Ethnography. Picton was formerly with the Department of Antiquities of Nigeria and includes information in the text that he collected in the field. Bibliographic materials range from 1885 to the present time. The maps focus on regions and peoples mentioned in the text and illustrations. Unfortunately specific names of countries are not included in the maps.

The emphasis is on technical analysis of textile production, rather than the usual geographical organizational approach. This emphasis creates a unifying device that allows the reader to deal with the intricacy and diversity of the subject matter. The choice of cultures represented reflects the strengths in the collections of the British Museum. In addition, the authors acknowledge and include discussion of other weaving traditions not represented in the British Museum in order to give a more comprehensive picture. The authors describe the exhibition as one "from sheep to shroud" and from "Morocco to Madagascar."

Within the chapters illustrations appear on almost every page. The color plates are high quality, doing justice to the broad range of colors and designs presented. Many of the black and white photographs present textiles and the textile process in an ethnographic context. Chapter I introduces the reader to the cultural setting of African textiles which function in utilitarian, social, political and economic ways.

Textiles that are not woven, such as bark cloth, felted fibers, and painted skin, are also included in the text. As a means of analysis, three variables are defined: nature and color of fibers, relationships between warp and weft,



and embellishment after manufacture. Women predominantly used the single-heddle type of loom, which can be set up within the home, while the double-heddle loom, with the long, narrow warp stretched out, requires a large area and weaving takes place in public areas by men. There are male and female production weavers, but in Morocco sewing and plaiting is done by the males of the Zayan.

Chapter II focuses on raw materials used in Africa such as bark, bast, cotton, raphia, silk, wool. Leather, hide, and sinew are also important as well as gold, silver, and lead for embellishment. A fascinating and detailed description of the preparation for weaving of each fiber follows. Interspersed with the technical information are historical pieces of information which add greatly to understanding the subject. Although there was a native source of silk, since the 17th century the Ashanti of Ghana, among other African people, unraveled European silk cloth to incorporate into their weavings. Today rayon is used primarily in place of silk.

The loom is the subject of Chapters III, IV, and V. Although finger and tablet weaving exist, most of the textiles produced are woven on the single-heddle loom, even though the double-heddle is more efficient. Irene Emery's *The Primary Structures of Fabrics* provides the textile terminology utilized throughout the text.

Weaving in Madagascar is explored in Chapter VI. This is a welcome if brief section; until now most information published on this subject is in French, not accessible to English speaking readers. The weaving traditions are distinct from the rest of Africa although similar looms are in use. Women are the weavers and patterning is done by warp striping, not with supplementary weft designs. Another distinction is the backstrap loom, not found on the mainland of Africa but common in Indonesia. Warp ikat dyeing is practiced and all fibers are in use.

Chapter VIII deals with the complex subject of pattern-dyeing. Dyeing before weaving, called ikat, was discussed earlier in the book with indigo being the most popular dye used.

Non-dyeing techniques applied to woven cloth are the subjects of Chapters VIII, IX, and X. Very few examples of drawing and painting on cloth have been collected.

On reexamination of the text, my eye was caught by a color plate on p. 36. A prosperous Moroccan carpet merchant is seated in front of his tent with brilliantly colored carpets surrounding him—all products of the upright single-heddle loom—a celebration of male and female power in African textiles.

Margot Schevill

*THE TECHNIQUE OF WEAVING* by John Tovey, 1983 paperback edition, Batsford, North Pomfret, VT 05053, 7½" x 10" format, 120 pp, paperback, \$10.50. ISBN 07134 38517.

It is good news to all serious weavers that this scarce book is now available in paperback edition. It is particularly welcome now that in the U.S. weavers are buying more counter-marche looms and are exploring in greater depth the capabilities of counterbalanced systems. The theme of the book is explained by the author in the introduction. "An endeavor to present the traditional techniques of weavers such as John Murphy and later Luther Hooper as applied to present day hand

weaving." Or, "an attempt to fill the gap between the general books and the technical books written primarily for industrial use."

The last statement might be somewhat misleading. The book is definitely written for the handweaver, the one who is serious enough about his craft to want to know how his loom functions, how to perform adjustments and how to use it with the utmost efficiency.

As in other general books, one finds chapters on looms, weaving accessories, warping, weaving and basic weave structures. With this book the reader will acquire more in-depth information on most of these topics.

After reading the first section, one can compare the studio equipment described by the author with one's own and make sensible judgements on both. The jack loom is ignored but all other types are clearly described and explained.

The second section deals with warping, including the warp preparation and the loom preparation. These speedy and efficient techniques described here are seldom found in other books.

Section three deals with yarn calculations based on yarn count systems and also with several important weave structures. Gauze weaves (loom controlled leno) are included as well as several finger manipulated techniques.

The last section deals with specialized techniques for the rigid heddle.

The text is well illustrated with black and white photographs and clear line drawings. There are even a few color plates to liven it up.

This book will never gather dust on the shelf, it will be referred to constantly by weavers of all levels of skills and will be specially prized by owners of counter-marche and counterbalance looms. The good index and glossary are a great help for quick reference.

*LE LANGAGE DU TISSU* by Patricia Hugues © 1982. Distributed by Textile/Art/Language, 62, Rue Hoche, 92700 Colombes, France. 8¼" x 11¼" format, 476 pp, paperback, price unknown. ISBN: 2 904267 00 X.

This is perhaps the most thought provoking book on textiles that I have ever read. The author expresses his love for cloth, its beauty and its merits as a means of communication. Through this book the reader acquires a vast amount of knowledge and a great sensitivity to different cultures.

Cloth itself carries messages through its patterns, its fibers, its structures. Sometimes the message is literal, sometimes it speaks by addressing itself to the sensitivity, the emotional, religious or intellectual state of the people exposed to it.

Cloth is also the means by which the author speaks to his readers. It carries his messages to us. The author uses cloth to talk about the artistic merits of many cultures, in many areas, in the past and present.

"It happens thus that woven cloth is the tangible means that I have chosen to express myself in the artistic field. I am convinced that

it is a completely up to date medium which permits the communication of concepts that cannot otherwise be expressed, and which is flexible, has special regard to one's self, to others, to extreme individualism or the most public collectivism."

"Starting from these subjective motivations I have come to grips with the objective functions which woven cloth performs all along our existence and this from the night of times and in all areas of civilization."

This freely translated quote from the introduction of the book reveals some of the very complex and philosophical thinking that is expressed in this text. It enters areas of material culture, textile history, symbolism, psychology and weaving techniques.

The communicative power of cloth is strong and the author shows how to become sensitized to it, how to listen.

The book is divided into several parts:

1. Specific and original paths of the language of woven cloth. This has two sections: A. General approach to the language of woven cloth. B. From the view point of old textiles.
2. Some major episodes of Mediterranean textiles from the 1st to the 15th century.
3. What can be read and not read from cloth as depicted in Western paintings (the conflict between the language of real cloth and rendering through the media of paint).
4. The language of cloth in present times.

Each of these parts has several loosely organized subchapters. Their topics are chosen to illustrate the points the author wants to convey to his readers and always deal with the power of communication of cloth. Many chapters deal with history but are not organized as a treatise on historical textiles.

This book is illustrated with many black and white photos, although the visual quality is rather poor.

Unfortunately the French text of this book is not easy to read because of the complex syntax. It requires a very good command of the language. How I wished there existed an English translation for it!

*THE MAGIC SHUTTLE* by Deborah Lorme Goodman, illustrations by Claire Wyzenbeck © 1982. Smithsonian Institute, P. O. Box 1949, Washington, D.C. 20013. 9½" x 9" format, 24 pp. \$3.50 + \$2.50 (quantity discounts available). ISBN 0 86528 017 7.

This storybook, written for children, was produced by the Smithsonian Institute to accompany its traveling textile exhibitions. It is the story of a little girl, Emily, who buys a shuttle in an antique shop as a present for her mother. The shuttle turns out to be a magic one and with it Emily travels through time and learns about various types of weaving that have been done throughout the ages. This awareness helps her to better understand the industrial and handweaving that is done today.

This wonderful little tale is beautifully illustrated and should please all children.

**A DYER'S MANUAL** by Jill Goodwin © 1982. Published in Great Britain by Pelham Books Ltd. Distributed in the U.S. by MPC c/o Technical Impex Corp., 190 Merrimack St., Lawrence, MA 01843. 8 1/2" x 10" format, 128 pp. hardcover. \$17.95 ISBN 0 7207 1327 7.

Jill Goodwin writes of her own experiences and the pleasure she has found in gathering plants and dyeing wool, using the simple equipment that can generally be found around the house. Even in her discussion of ancient dyes, there is emphasis on the plants that she has grown herself. No previous dyeing experience is needed to enjoy reading this text and to follow the instructions for extracting color from the plants. The pace of the book is leisurely, with anecdotes drawn from the author's 50 years of involvement with natural dyeing and from her speculations on how primitive man may slowly have perfected the craft of dyeing.

The author always stresses the joy of discovery and experimentation. She herself is drawn to the ancient traditional craft of dyeing because she admires the luster and mellowness of natural colors. She wants to share the pleasure she has found in carrying out a primary process from the beginning to the end, from raising animals for fiber to producing colorful cloth.

The book contains technical information on preparing and dyeing cotton, linen and silk, but wool is the fiber discussed the most. The chapter on mordanting is clear and easy to use. The basic system of extracting color from plants is assembled in one single chapter, Test Dyeing. The method can be used for any plant. The author then gives specific examples of dyes extracted from weeds and garden plants.

The chapter, Ancient Dyes, includes shellfish dyes, insect dyes (kermes, St. John's blood, cochineal, lac) as well as plant dyes (logwood, safflower, fustic, quercitron, tumeric, saffron, henna, sumach, weld and madder). There is an entire chapter on indigo which includes important information on the cultivation and preparation of woad. The last category of dyeplants studied is lichen.

In the last chapter of the book the author includes hints on how to teach spinning and dyeing in schools and how to make use of vegetal dyed yarns. The book ends with a useful chart on colors that one can extract from a long list of plants, a list of protected plants (in Britain) and of poisonous plants. There is a bibliography, list of suppliers, and index. The book is illustrated with B/W and color photography. However, there are few illustrations of plants and of the colors that can be extracted from them.

**PLY-SPLIT CAMEL GIRTHS OF WEST INDIA** by Betsy D. Quick and Judith A. Stein © 1982. Pamphlet Series Vol. I, #7, published by the Museum of Cultural History, UCLA, Los Angeles, CA 9024. 8 1/2" x 11" format, 64 pp, saddle stitched, price unknown.

The technique of weaving camel girths is akin to braiding or finger weaving. Yet it is based entirely on the fact that the yarns are plied. The structural elements pass through each other between the strands where the ply has been split.

I had heard about such techniques being used in Ancient Peru but never found a great deal of literature on the subject. This book deals with camel girths woven in the extreme western desert of India. The authors spent many months studying these white and black goat hair girths which display strong geometric patterns achieved by means of unusual twining techniques. These belts are strong and firm and the patterning is achieved by manipulating the white and black strands of the braid.

There are several types of camel girths, some very complex such as the double face girths which allow for very intricate patterning. Each type and their design potentials is discussed and illustrated.

In the first chapters the authors discuss the regional and cultural setting in which these girths are found. The text is lively and the reader joins the authors in the search for more knowledge about these fascinating girths. Next, we all search for a teacher. The authors found one and translate all the steps involved in making these girths into a clear and informative text for their readers. The various structures of ply-splitting are clearly illustrated with line drawings.

This book must find its way into the library of anyone interested in the structure of non-woven fabric interlacements. Textile collectors too will find this book useful for identifying very unusual patterned belts.

**BOUTONNE D'HIER ET D'AUJOURD'HUI** by Les Tisserands-Créateurs de Québec © 1983. Published by Les Tisserands-Créateurs de Québec c/o Louisette Lafleur, 1191 De la Rivière, Cap Rouge, Que. Canada 60A 1K0. 8 1/2" x 11" format, spiral bound, 50 pp. \$8.00 + \$1.50 P/H (Canadian currency).

This interesting book shows two aspects of a weaving technique in which a supplementary pattern weft is pulled up to make loops and thus create a raised pattern called *boutonne*. The first aspect is the traditional use of this texture which was especially popular for household furnishings. One of the authors, Michel Laurent, traces the history of *boutonné* in Quebec back to the 18th C. This essay on the traditional techniques is illustrated with examples preserved in museums. The author discusses the materials, techniques and patterns.

The second aspect is the contemporary interpretation of *boutonné*. The technique is described and there is also a list of hints for successful results. Each current member of the organization of creative weavers in Quebec had to weave a project for publication in this book. The technique had to be *boutonné* but the interpretation was up to the individual artist. Each one of these projects is described with detailed instructions and is beautifully illustrated with B/W photography. There are about 25 projects and they show great variety and imagination.

The book includes a bibliography. The entire publication is a successful group project and, while written in French, is rather easy to use and to understand. The technique of *boutonné* is basically a simple one and can be done on a two-shaft loom.

**SPEED TAILORING** by Mary Roehr, © 1982. Distributed by Custom Tailoring, 654 N.E. Royal Ct., Portland, Oregon 97232. 8 1/2" x 11" format, 41 pp, spiral bound. Price unknown.

Making your own tailored blazer must be a frightening thought for someone with a minimum of sewing skills. Yes? No, not when you have this book in front of you.

"The purpose of this book is to help the student construct a basic lined blazer using the fastest and most effective speed tailoring techniques. *Speed Tailoring* is a new method of tailoring which allows us to achieve a very professional look in a very short period of time. This is possible because of the reduction of handwork, new methods of sewing and trimming, and new materials such as fusible interfacing."

The author starts with pattern selection and ends the book with final pressing and care. All the intermediary steps are discussed and illustrated with great care. The text is well laid out and easy to follow.

This book is highly recommended to anyone who wants to attempt making his/her own blazer; especially to the handweaver who often cannot find a seamstress willing to work with handwoven cloth and is forced to do his/her own tailoring.

**THE BUSINESS OF ART** edited and with an introduction by Lee Evan Caplin © 1982, published in cooperation with the National Endowment for the Arts by Prentice-Hall, Inc., Englewood Cliffs, New Jersey. 7 1/4" x 10" format. 383 pp. \$22.95 ISBN 0 13 106518 1

The editor of this tome, artist-attorney Lee Evan Caplin, has brought together a group of nationally known art dealers, art lawyers, tax authorities and successful artists to write about survival tactics for practicing artists. Some of the topics included in the 27 chapters are:

1. All phases of business planning from modes of doing business, finances to estate and gift tax planning.
2. Protecting you and your work; copyright, insurance and health hazards.
3. Marketing; portfolio, promotion, contracts.
4. Dealing; galleries in big city areas, wholesale, etc.
5. Alternatives; museums, commissions, corporate collections.

Even though there may be millions of artists in the United States, few will have the good fortune to benefit from every chapter in this book. It is still nice for the artist to dream and plan for the possibility of such success that estate and gift taxes are important. These subjects and others included are most valuable for the collector, individual or corporate. Other subjects—retirement, business practices, etc. make the working artist aware of what one should include in one's planning.

Photography in preparing one's portfolio (with its excellent bibliography) is one of the more valuable chapters to the artist, as is the chapter on health hazards. The reference material provided for both of these subjects are extremely pertinent.

Since every chapter is written by a different

authority, the various points of view and writing styles add vigor to the book. Among all the books on the aspects of business within art, this one is the most complete and comprehensible and is recommended as a part of the resources for any artist or craftsperson.

Helen B. Davis

**YOU CAN DESIGN, AN ADVENTURE IN CREATING** by Sharon La Pierre © 1983. Published by Genre Communications, Ltd., 5697 Xenon Court, Arvada, Colorado 80002. 5½" x 8½" format, 73 pp. \$8.95 ISBN: 0 9610948 0-X.

In the preface the author states that this book is written by an artist for other artists. In reality the book is a revised and expanded version of an earlier publication *Design and Creativity, earlier Drawing-out The Creative Potential By Understanding Design* which evolved from the author's teaching experiences in beginning design classes with college students. Thus the book is directed to those interested in the design process and offers the most to the uninitiated or the neophyte.

One of the surprises of the book is the inclusion of 29 colored plates of art work including 11 of the author's delightful baskets and fiber pieces. The written material covering "Creativity and the Distillations of Ideas", "What is Design?" "Development of Individual Potential" and "A Critique and Evaluation of the Application of the Basic Design Principles" is direct and simplistic, leaving one to wish for an expansion of ideas and concepts.

The physical format does not equal the premise of the book; somehow if one is writing a book about design, shouldn't the book sing with outstanding visual impact?

Helen B. Davis

**NATURAL DYES FOR SPINNERS AND WEAVERS** by Hetty Wickins © 1983. Published by Batsford, North Pomfret, VT 05053. 7½" x 10" format, 96 pp., paperback, \$10.50. ISBN 0 7134 20219.

Over the last 13 years, there has been a strong awareness among people working with fiber that a lot of fun and color is possible from extracting dyes from plants. Some studied the historical pre-aniline dyes, others preferred to experiment with the weeds and flowers growing around them. This rediscovery of the dye potentials of plants has led to a plethora of books on the subject. This book, by Hetty Wickins, is somewhat a late comer in the series. It is a good book, carefully planned, well written and easy to follow. As with all the preceding ones, the emphasis is on the great satisfaction one derives from producing one's own colors. Most chapters do not differ greatly from what has been written in other dye books reviewed in this column before: equipment, preparation of fibers, methods of dyeing with or without mordants, historical dyes. The chapter on mordanting is especially good in this book.

Hetty Wickins, as most other authors, writes mostly about the dyeing of wool fiber, yet this book has more on dyeing cotton, silk and linen than others.

I certainly would recommend this book for beginners. Advanced dyers would probably not find a great deal of new information but may want to compare notes. The author has

organized some of her results in the form of neat informative charts.

The book is well illustrated as a dye book but does not have many photos or drawings of plants.

**INKLE WEAVING** by Lavinia Bradley © 1982. Published by Routledge & Kegan Paul. Distributed in the U.S. by Mercedes Distribution Center, Inc., 160 Imley St., Brooklyn, N.Y. 11231. 6¾" x 9¾" format, 83 pp. Paperbound. \$7.95. ISBN 0 7100 9086 2.

This book serves well as a first course in inkle weaving. The basic techniques are well explained and there are plans and instructions for making the loom. The set up of the warp and the different steps of the weaving process are clearly illustrated with line drawings. However, the book is weak on patterning. Some designs generated by the color effects of the warp are mentioned but none are illustrated. There are a few B/W photos of patterned belts and examples of projects that can be done with inkles but the quality, in general, is poor. The author describes a good variety of techniques that are applicable to inkles, such as shaping bands, making tubes, curving bands, making slits and fringes and wrapping warps.

The pick-up techniques which are commonly done on narrow bands are to be found in two seemingly unrelated chapters and are described in a non-standard terminology. For example, simple pick-up, double pick-ups, intensive pick-ups, Summer and Winter in pebble weave (with reference to Bolivians and Navajos). The chapter on pick-up for weaving letters is much more consistent and helpful. There is also a discussion on wet effects and a few ideas for projects. With so many works written on the subject of narrow bands to draw from, it is rather surprising that the organization of this book is so poor. A beginner, however, will reap some good material from it but will have to go to other books to explore the full potential of inkle weaving.

**THE MOLA DESIGN COLORING BOOK** by Caren Caraway; **PERUVIAN TEXTILE DESIGNS** by Caren Caraway; **PERSIAN CARPET DESIGNS TO COLOR** by Mehry Reid; **ENGLISH CREWEL DESIGNS, SIXTEENTH TO EIGHTEENTH CENTURIES** by Francis M. Bradbury © 1981, 82, or 83. The International Design Library, Stemmer House Publishers, Inc., 2627 Caves Rd., Owings Mills, MD 21117. 8¾" x 11" format, saddlestitched. About 48 pp. each. \$2.95 per book.

These four books, which are part of a larger series, are absolutely delightful. They are books for readers of all ages. For children, they are unusual and imaginative coloring books that will make the child aware of many styles of design and stimulate his interest in other cultures. The designs are bound to stimulate creativity in the use of color, too. The adult will appreciate the information given in the introduction of each book. This brief text is an overview of the culture to which the designs are native.

The designs themselves are delightful to look at and are an excellent inspiration for projects. The designs of these four books are especially suited for textiles such as knotting,

embroidery, applique, quilting and tapestry. The designs can also be interpreted in other media such as painting, silk screen, paperwork, woodcarving, etc.

These books make great inexpensive gifts and I cannot imagine anyone who would not be enthusiastic about collecting them.

**PACIFIC BASKET MAKERS, A LIVING TRADITION** edited by Suzi Jones © 1983. Published by the University of Alaska Museum, Fairbanks, Alaska. Distributed by Consortium for Pacific Arts and Cultures, P.O. Box 4204, Honolulu, Hawaii 96813; 8½" x 11" format, 80 pp., paperback, \$8.95.

This book is subtitled: "Catalog of the 1981 Pacific Basketmaker's Symposium and Exhibition" and does contain a 15 page annotated catalog with photos and full description of the objects. This alone is worth the price of the book but much more is offered by several authors who have contributed to this volume.

For one week in May 1981, seventeen traditional, indigenous basket and fish and nettrap makers from the Pacific Rim met together in Anchorage, Alaska, to discuss what is happening to the values and cultural expressions of their people. Also participating in this symposium were three "guest humanists": Steven F. Arvizu, Roger Rose, and Barre Toelken.

Each of these specialists contributed a section to this book. "The Basket Imperative" by Barre Toelken deals to a great extent with baskets as an important art form which combines traditional and creative elements. He delves into the lives of the makers and their dedication to their art. "North American and Pacific Basketry: Some perspectives" by Roger Rose, deals with techniques and also with history. Various techniques are clearly illustrated with line drawings and the ethnic subgroups which are represented in the symposium are documented with geographical, historical and cultural information. "Cultural Preservation and Pluralism: strategies and policies for survival in the Pacific and the United States," is the topic discussed by Steven F. Arvizu. The book shows a great sensitivity to the art of the basket maker and has captured it in exquisite photographs, many in color.

**IDENTIFICATION OF VEGETABLE FIBRES** by Dorothy Catling & John Grayson © 1982. Published by Chapman and Hall Ltd., 11 New Fetter Lane, London, EC4P 4EE, England. Distributed in the U.S. by Methuen, Inc., 733 Third Ave., New York, N.Y. 10017. 7½" x 10" format. 90 pp. of text, 8 pp. of plates. Hardcover. \$27.50. ISBN 0 412 2100 7.

The fibers included in this study are flax, hemp, sunn hemp, ramie, jute, kenaf, roselle, sisal and abaca. By means of intensive study, special preparation of the fibers and powerful microscopes, the authors have isolated enough characteristics of these fibers so that identification is possible even if only small specimens are available. This highly specialized detective work may have to be conducted by museum staff members in order to document unknown textiles. The information is based on very scientific data and will rarely be referred to by ordinary fiber craftspeople.

*JOININGS, EDGES, AND TRIMS* by Jean Wilson © 1983. Van Nostrand Reinhold Co., Inc., 135 West 50th St., New York, New York 10020. 7" x 10" format, 144 pp, hardcover, \$25.50. ISBN 0 442 295 383.

Jean Wilson is very well known for her workshops on finishing details for handmade textiles. She knows the importance of the "final touch", of the decorative detail and of the well crafted assembly of a garment. However, not everyone has a chance to take one of these workshops. For those, Jean Wilson has gathered her wealth of advice and techniques into this recently published book.

This book is not only for weavers. Knitters, seamstresses and needleworkers will glean many useful ideas as well.

Many of her basic techniques can be learned by weaving a long narrow sample. This is the approach the author uses when she teaches. This entire procedure is outlined in the first chapter. The following chapters deal with specific ways of handling edges, ends, hems, joins, and seams. Some of the finishing touches are merely practical, others are highly ornamental.

The author's love for applied decorative elements is evident in the chapters on trim, fringes, tassels, embellishments and closures.

The table of contents gives few details and it is rather difficult to anticipate what is included in each chapter. Fortunately there is an index which will help the reader find one's way through the large variety of techniques which are touched upon in this book.

The illustrations are mostly black and white photographs of pertinent details. There are also good line drawings to clarify the techniques.

The layout of the book lacks in clarity. The type of the captions and text are very similar which makes the book harder to read. A listing of the stitches and of the various techniques would have been most useful.

---

*THE SELF-SUFFICIENT WEAVER* by Jennifer Green © 1983. Published by Batsford, North Pomfret, VT 05053. 7½" x 10" format, 120 pp, hard cover, \$18.95. ISBN 0 7134 0763 8.

This book is written for those who plan to start to weave and for teachers who have to introduce a group of students to the craft.

I very much like the approach in chapters 1 through 9. *The Self-Sufficient Weaver* acquires his knowledge of wool yarn by first looking at sheep, then at fleeces, then at spinning (with drop spindle), then at dyeing (with plant dyes). The equipment needed for his/her first weaving lessons is minimal. The student starts with finger woven belts, then weaves on a home-made cardboard loom. With little or no investment, he graduates to weaving on a frame loom and learns about tensioning devices. The chapter on inkle loom weaving introduces the reader to the first loom which he/she will have to build. The plans and the instructions are clear. The basic techniques for weaving on it are well described.

The chapter on backstrap weaving is treated rather skimpily. The author does not hint at the great design potentials of such a loom. The discussion of the rigid heddle frame will prepare the weaver for the loom he/she is ultimately encouraged to weave on: the rigid heddle loom. The 4-shaft floor loom is mentioned but not discussed at great length.

My objection to chapters 9 - 10 - 11 and 12 is that they deal with looms, with setting up the warp, with weaving and yet there is not a single picture, drawing nor photograph of any loom. How is the self-sufficient weaver to know what a loom looks like?

Chapter 13 (Selling Your Weaving) is completely out of place in this book. By the time the reader has absorbed the knowledge given here he/she should be much more concerned about further education, more imaginative designs and better craftsmanship than with the sale of his/her goods.

---

*DESIGN & SEW IT YOURSELF, A WORK BOOK FOR CREATIVE CLOTHING* by Lois Ericson and Diane Ericson Frode © 1983. Published by Lois Ericson, Box 1680, Tahoe City, CA 95730. 8½" x 11" format, 120 pp, spiral bound. \$14.95 ppd. ISBN 0 911985 00X.

For the authors of this book, garments are not merely functional objects, but instead, they look upon clothing as wearable art. They emphasize design and creativity. They deal mostly with trim and surface embellishments and include many sewing techniques. These techniques are not the ones usually found in tailoring books but they will help solve special problems of construction, those which are necessary to interpret certain designs, those which add surface embellishments and those which produce a well-crafted and well-finished garment.

The first chapter is on designing. This section is too short and rather superficial. Some interesting concepts are mentioned but not explored. The reader will increase his/her awareness of design but may have a hard time applying it to the creation of garments.

In the next chapter the authors show how designs can be inspired from costumes. This is dealt with very successfully. The illustrations are exquisite. Each costume generates many ideas for interesting patterns, shapes, fabrics and decorative elements.

"Sewing Techniques" occupy the largest portion of the book. Most are ideally suited for adding creative elements to clothing though all are very useful and informative. They include: working with bias strips, covering cording, piping, wrapped cording, ropes, closures such as buttonholes and frogs, buttons, ties, and tassels.

The book includes many ideas and techniques for adding surface decoration to a garment. There are interesting machine stitching techniques, lots of embroidery, beading, applique, ribbon work, needle weaving and braiding. Tucks and pleats are described as well as many finishing techniques such as seams, joins, facings and pockets.

The book contains a wealth of information that is a bit out of the ordinary and that will help the designer give that very personal

touch to his/her clothing.

The text is very lively and beautifully illustrated. It is a pleasure to leaf through the pages. The reader will glean many new ideas and enjoy the clear instructions on how to accomplish these creative pattern elements.

---

*CLOTH AS A METAPHOR: NIGERIAN TEXTILES FROM THE MUSEUM OF CULTURAL HISTORY* by Jean Borgatti © 1983. Monograph series #20, published by the Museum of Cultural History, UCLA, Los Angeles, CA 90024. 8½" x 11" format, 64 pp, saddle stitched. Price unknown.

This publication accompanied an exhibition at the UCLA Museum of Cultural History held in May-June 1983. In fact pages 46 through 62 constitute a catalogue of the museum collection. Here the pieces are listed according to techniques: men's weave, women's weave, mill-woven, non-woven cloth.

The text preceding this catalogue shows the importance of clothing and textiles as cultural artifacts: "cloth in combination with behavior defines humanity". This thesis, which is essentially the same as in the book *Le Langage Du Tissu* reviewed elsewhere in this column, is developed by the author for a specific area of South Nigeria called Northern Edo. This area is especially rich in cultural traditions and variety of textiles. Life, religion, government and rituals are interconnected with the cloth that is tied around the human body.

The author describes many types of textiles and takes a look at the general use of clothing by several cultural groups of the Edo region. She focuses on the social importance of textiles and the messages that cloth conveys. The title "Cloth as Metaphor" suggests how strongly this African cloth speaks. This is brought out with the greatest emphasis in the sections "Fabric of Sculpture" and "The Making of a Masquerade."

This monograph is well illustrated with black and white and color photographs. Such books are most valuable because they bring home to the reader a wealth of information on ethnic textiles which are still relatively unknown, and also because they are sensitive to the cultural and sociological importance of clothing. ■

---

## ERRATA

Vol. VIII, #2, issue 30, Fall 1983. The credit for the cover photo of that issue should go to Carol Havey.

Vol. VIII, #2, issue 30, Fall 1983 p. 40. To make this program work on the TRS80, the following additions of semicolon must be made: Line 720 change CHR\$(239); REM to CHR\$(239);:REM CHR\$(334);:REM



1. Hiking jacket with button-on hood, created by Bettie Roth

## A JACKET FOR HIKING by Bettie G. Roth

Have you ever been out hiking on a crisp fall day, and wished your jacket had lots of pockets to hold your trail mix, maps, car keys, tissues, and more? Now you can wear this delightful handwoven hiking jacket that will free your hands and your spirit! I chose navy blue mohair-acrylic and a red, white, and blue acrylic for a color combination that is fun, and for the softness and stability these fibers

would create. A real advantage with acrylic yarns is that the measurements taken on the loom, with the tension released, can be trusted to be very close to measurements taken after the yardage is washed and steamed.

After I decided to make a jacket with many pockets, I sketched a cartoon and took it to a yardage shop to find a commercial pat-

tern. I didn't expect to find a pattern with 14 zippers; but there was a Butterick 4297 which had the same basic design as the cartoon.

After cutting out the paper pattern pieces, pinning them together, and trying them on for size, I cut out a trial jacket of a cotton-polyester material. Then I basted the cotton-polyester jacket pieces together to check the fitting. With this done, it was time to mark the cotton jacket with chalk for the placement of the zippers. I transferred these marks to the paper pattern and then I purchased fourteen decorative zippers.

### Zippers

- 1 - 24" red reversible separating zipper (front of jacket)
- 1 - 9" red zipper (collar)
- 2 - 7" blue zippers } (front of jacket)
- 2 - 7" white zippers }
- 2 - 7" red zippers }
- 2 - 5" blue zippers } (sleeves of jacket)
- 2 - 5" white zippers }
- 2 - 5" red zippers }

I chose a plaid pattern for the handwoven fabric. The slits for the zippers were going to be woven in, and there would be little if any problem in matching the pattern. I tried a sample on the loom and made certain the sett was correct, and the shrinkage was minimal when washed. I decided to weave the slits for the zippers into the fabric as I worked on my loom.

**Warp:** Navy blue mohair acrylic; red, white, and blue acrylic yarns

**Weft:** Same

| color order of warp |                         |
|---------------------|-------------------------|
| navy                | 16                      |
| white               | 1                       |
| red                 | 1                       |
| blue                | 1                       |
|                     | 20                      |
|                     | working ends per repeat |

| color order of weft |                         |
|---------------------|-------------------------|
| navy                | 20                      |
| white               | 1                       |
| red                 | 1                       |
| blue                | 1                       |
|                     | 24                      |
|                     | working ends per repeat |

**Sett:** 20 epi (80/10 cm)

**Width in the reed:** 28" (71 cm)



2. Back, with tab closures

**Length of warp:** 5 yds. (4.5 m)

**Threading, tie-up, and treadling:** Plain weave and twill blocks. See Fig. 1.

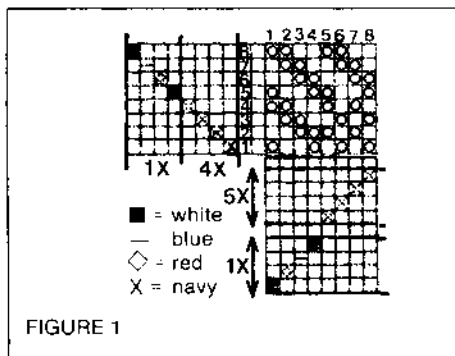

FIGURE 1

**Weaving:** I proceeded with weaving the fabric, using the marked pattern pieces as a guide. I wove the back as one piece. I used a set of shuttles to weave the two halves of the front at the same time. The sleeves were woven separately; remembering to weave the second sleeve in reverse. I measured each section, allowing an extra inch at each end for shrinkage.

As I wove the slits for the zippers, I used butterflies until the slits measured the desired length. The plaid pattern helped me to be accurate about the length of the slits. You might question taking the time to weave in the slits; why not just cut the material where you want to place a zipper? My reasoning is that a good finished edge is ob-

tained which prevents threads pulling out around the zipper; and strength is added to an area which receives a lot of wear and tear.

After the material had been machine washed and air dried, I placed the pattern pieces on the handwoven fabric, matching up the slits on the paper pattern pieces to the slits on the fabric. I cut the pieces, and finished all raw edges on the machine to prevent any unravelling.

**Assembly:** The first step in the sewing was to insert the zippers and pockets. For the zipper openings, cut a piece of fabric about 3" wide and 2" longer than the size of the opening. I used cotton-polyester fabric. Placing right sides together, put this piece of fabric over the

opening, extending one inch over each end. Stitch  $\frac{1}{4}$ " in from each side of the woven opening and across the ends. Cut an opening in the cotton-polyester where the slits exist, cutting diagonally into the corners. Draw the material through the slit to the wrong side. Turn the seam edges away from the opening and steam press so that only the woven material is visible on the right side. Matching up the plaid pattern of your woven material, baste zippers in place and then sew them securely on the machine. Cut another piece of material  $8\frac{1}{2}$ " x  $8\frac{1}{2}$ " and to the back of the facing material to which the zipper has been attached, sew down and across. This makes the pocket. Each zipper is finished in the same manner.



3. Lots of pockets

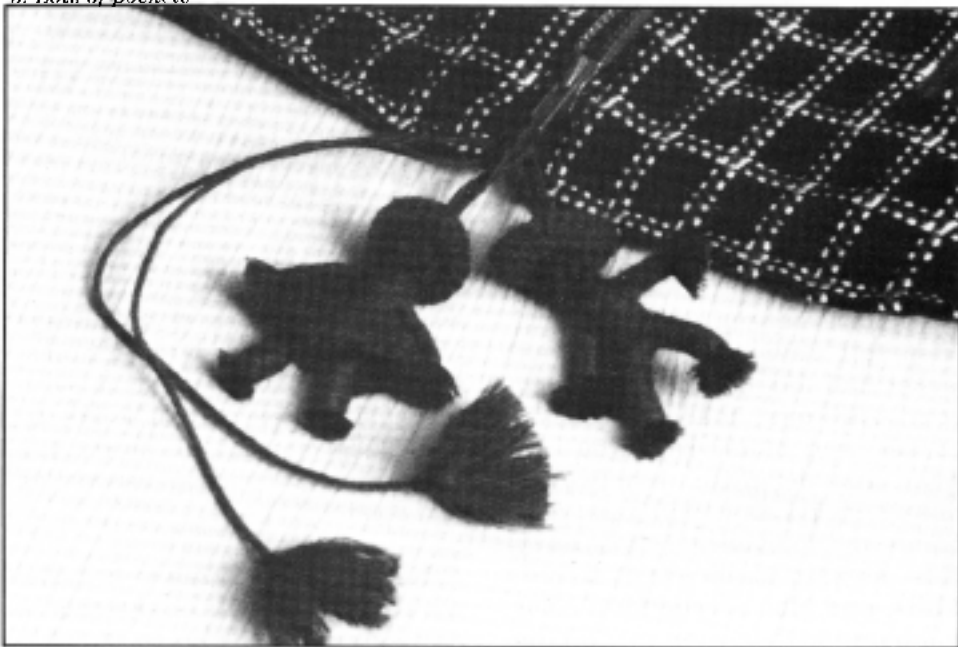

4. "Just for fun" zipper pull with kumi himo braid

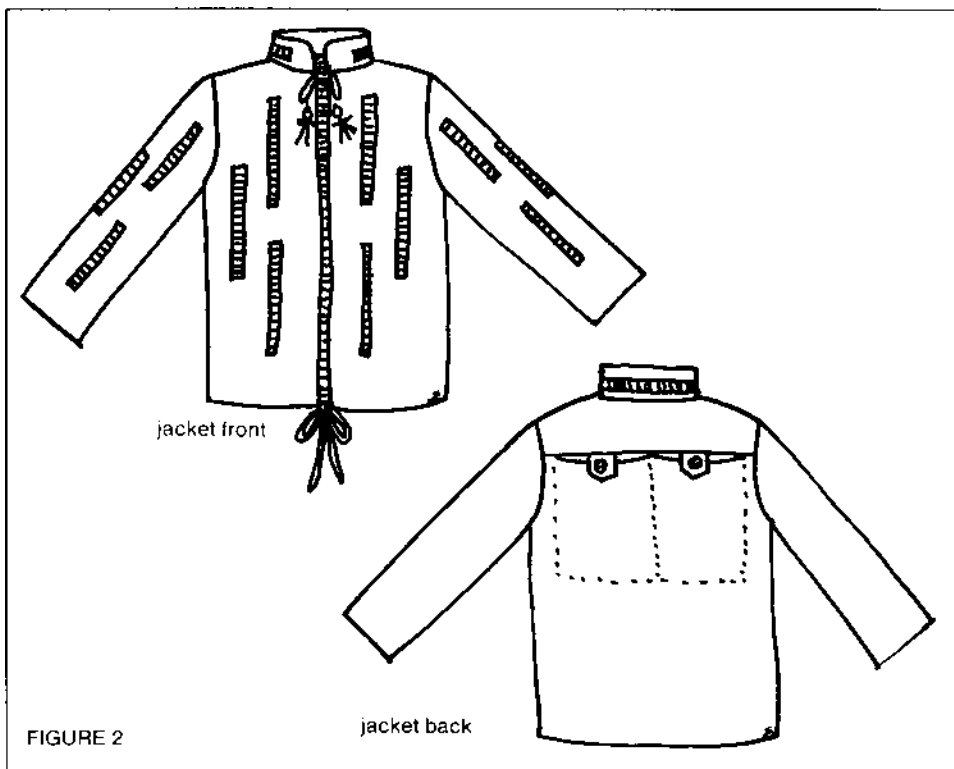

FIGURE 2

The next step is to finish the pockets on the back of the jacket. I chose a pattern with a back yoke so I could sew two large pockets into the back for maps, books, or whatever.

The yoke was sewn about 2¼" in from each end with the center portion left open. Another slit pocket to fit the opening was sewn in with two buttonhole flaps inserted at the same time. The area was divided and stitched down the center to make two deep pockets.

The next step was to disassemble the cotton-polyester jacket sewn earlier and use those pieces for underlining for the woven material. With that done, the directions for assembling the jacket from the commercial pattern could be followed. The contrasting material chosen for the lining of the jacket was a water repellent red nylon, so that when caught in a rainstorm all that needs to be done is to turn the jacket inside out and remain dry.

A hood was also designed and cut from both the woven material and the nylon waterproof material. With right sides facing each other, the hood was sewn together, leaving a small opening on the bottom. The hood was turned inside out and

the opening was stitched closed. Three buttonholes were placed on the neck edge of the hood, one at each end and one in the middle. Buttons on both the woven fabric and the nylon fabric were sewn back to back and matched up with the buttonholes on the hood. The hood is reversible and can be buttoned on and used when weather is crisp and a hood is desirable; or it can be stored in one of the large pockets.

In place of a commercially purchased drawstring, I made a *kumi himo* braid out of the same yarns used in the handwoven fabric.

Just for fun I made a zipper pull for the 24" zipper out of yarn in the form of a little girl and boy. I used *kumi himo* braid to attach it to the zipper.

The finished product is a *unisex* jacket. There aren't any darts and it can be worn by anyone, any age.

Happy hiking!

*ABOUT THE AUTHOR: Bettie G. Roth is a member of HGA, Sacramento Weavers Guild, and is a consultant to the American River College Textile Library. She lectures and gives workshops pertaining to weaving. She is co-author of The New Handbook of Timesaving Tables for Weavers, Spinners, and Dyers.*

## GRANDOR YARNS

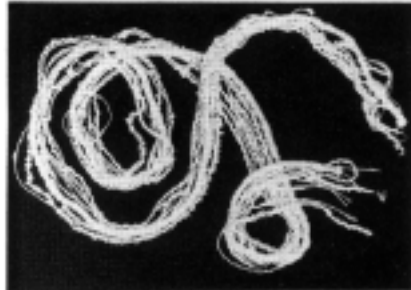

"For the unusual yarns in —  
cottons wools  
linens silks  
mohairs chenilles  
mixtures

McMorran yarn balance

Complete set of samples \$2.75

WHOLESALE ONLY

GRANDOR INDUSTRIES, LTD.

Dept. WJ, P.O. Box 5831, 4031 Knobhill Dr.  
Sherman Oaks, CA 91403 (213) 784-5855

- Yarnblockers (fully finished and in kit form)
  - Squirrel-cage Swifts
- Proven designs, beautifully crafted in hardwood.  
Color brochure \$1.



**Traditional  
Fiber Tools**

885 Glendower,  
Ashland OR 97520

● DEALER INQUIRIES INVITED

WEAVING SUPPLIES

WARP YARNS & FILLERS

CABLE CORD IN COLORS

MACRAME JUTE

SAMPLES 1.25

**E. F. SHAW & COMPANY, INC.**

SUCCESSOR TO:

**TINKLER & CO. INC.**

P.O. Box 17

Norristown, PA 19404

(215) 272-2228

# PRODUCT REVIEWS

## "THE WEAVER" AND "NAVETTE" TWO DRAWDOWN PROGRAMS FOR THE APPLE II

reviewed by Bruce Bohannon

Computers may become as common in weaving studios as shuttles. Since the first computer program for weaving-drawdowns appeared in 1978, a steadily increasing number are now available for home computers. Each program has unique features which a weaver should carefully consider before using it as a design tool to create weaving patterns without doing them by hand. For example, some are easy to use for beginners but are tedious to work with for an experienced user; some are not forgiving of mistakes; some cannot be adapted to your brand of computer or printer. No one program does everything! "The Weaver" and "Navette" are two new programs for the APPLE II family of computers that present some interesting contrasts. Let's look at their features.

"The Weaver", written by David L. Natwig, simulates an 8-shaft loom with 10 treadles controlling up to 280 warp threads and 160 weft threads. The weaver can interactively create a pattern as though seated at the loom. Instant viewing of the reverse side of the fabric is possible. An excellent tutorial with adequate examples guides the weaver through the two separate programs that comprise "The Weaver". Loom set-up and the resulting pattern are both stored on diskette. Printer output, with popular APPLE II hires screen dump firmware, gives one the feeling of fabric.

"Navette", written by Mark Opperman, is a software tool that reflects the APPLE Pascal operating environment in which it was written. I will return to this aspect of the program later. A maximum of 140 warp and 96 weft threads can be displayed for 16 shafts. "Navette" uses an editor for entering the warp and weft that weavers will be very comfortable with as it is a video display version of what is done on paper. There is an analysis function to compute warp, weft, and tie-up from a pattern that the weaver has drawn on the video screen. The program solves a repeat of up to 66 warp and 48 weft threads for a 16-shaft loom. Both pattern and loom data (tie-up, threading, treadling) are stored on diskette and can be printed out.

Let's see how the two programs work. First impressions are important, or so mothers say! Both "Navette" and "The Weaver" take about 25 seconds of whirring of the disk drive to set themselves up for the user.

"Navette" displayed its logo and then would do nothing for me. Time to read the manual! Always a good idea, but, for me, one that comes after trying the diskette in the drive first. (My motto is that pressing keys should not bring any harm.) The problem turned out to be the Videx Video-term card. Once I removed the Videx card, everything worked fine. While "Navette" includes an updating feature to customize itself by turning off the 80-column card, no parameters were given for the Videx Videoterm card, a top-selling 80-column video output card that resides permanently in my system expressly for use in the APPLE Pascal operating environment. To interact with the program, prompts to

the user are in the style of the APPLE Pascal operating environment. In each model of the program, a series of commands are displayed across the top of the screen. Each command is listed with one letter capitalized, usually the first letter in the function, and followed by a right parenthesis [e.g. A(nalysis)]. Only one key stroke, the letter capitalized, is necessary to select from the command list. This is an efficient way to save key strokes. However, I find it too like a computer operating environment, not a user-friendly situation for weavers who often are novice computer users. The command line is difficult to read on my monitor because Opperman has created a special character set for the APPLE hires screen. In addition, not all of the commands available for a particular function are in the command list. Additional commands that are not displayed initially are not prompted when the user types '?', a feature used in some APPLE Pascal commands lines. I feel that all commands available at a decision point in a program must be prompted without consulting the instructions that come with the diskette. Even the most experienced user forgets how to access some function; it is much easier to ask for help from the program than to go digging for the documentation.

"The Weaver" has two parts, "The Main Menu" and "The Design Module". When the distribution diskette is inserted in the disk drive, the "Main Menu" module is loaded and one can view and print a drawdown that has been stored on diskette. Only 9 patterns can be stored on diskette with the programs, an unfortunately small number that results from the hires screen being stored directly on the diskette as well as the loom data. The "Design Module" is the program that the weaver uses to create new designs and to study their weaving potential, the fun part of a drawdown program. Drafts can be recalled from diskette for further experimentation or new loom data can be entered from the keyboard. After loading loom data, the weaver can start pushing treadles and begin to weave new patterns. There are 20 commands available to work with the design (e.g. enter a treadling sequence, enter a weft color, erase a weft thread). From "The Design Module", the weaver can change the warp and tie-up of the present loom data and can save the pattern to diskette for use by "The Main Menu".

While every well designed computer program seeks to be complete in itself and independent of additional instructions, documentation is needed to introduce the first-time user with program control. Because of the excellent tutorial accompanying "The Weaver", I found that I was able to begin working with it quickly and could see what the options are in using it. Natwig includes a number of examples that lead a beginner through the program without floundering. In contrast, in the documentation for "Navette", Opperman frequently writes that something is possible, but leaves it for the user to figure out how to do it. There are not enough examples to help a novice through the maze of options available in this sophisticated design tool. I got the feeling that there is much more to this program than I was able to find on my own. A carefully written tutorial with sufficient examples would make "Navette" much more effective.

In both "Navette" and "The Weaver", I felt that I was in control of the program, rather than the computer programming me. The user is prompted with a list of options to select program functions.

It is possible in both programs to list the patterns stored on diskette. However, neither allow you to select a pattern from the list while it is on the video display. I never can remember the complex way I have described a pattern long enough to go to the command for listing the names and then entering the correct name after the screen has been erased. "The Weaver" is particularly inelegant in this manner as all of the files stored on a diskette are listed. One must sort through programs to find patterns.

More effort is needed on this feature in both programs to help the user get the most out of retrieving drawdowns stored on diskette for future use.

Because it is so much easier to study a number of patterns on paper than on the video screen, drawdown programs must have some way of printing them. However, there is a wide array of printers, each with their unique control commands. "Navette" is designed to send control characters to set-up the printer, but insufficient examples are given to allow a non-computer user to adapt it to their brand of printer. "The Weaver" has more than adequate instructions on how to print the APPLE hires screen used to display patterns. One can either use the GRAPHTRIX program available from Natwig or your local computer store for your printer or use a printer interface card with firmware for graphics printers, such as the GRAPPLER or APPLE DUMPLING. I followed his instructions for changing the program for GRAPPLER output and was able to get print-outs in a few minutes.

Both programs have a zoom feature that enlarges the upper right hand corner of the pattern. This mode is useful to study thread interaction on a smaller scale. "The Weaver" has a maximum magnification factor of 99 and "Navette" is programmed at 70 by 48 threads (i.e. 2 times magnification).

Because of limitations imposed by the color graphics output of the APPLE II, neither of the programs is effective for investigating color-and-weave effects.

The authors of "The Weaver" and "Navette" have invested a great deal of time and effort in producing high-quality design tools for weavers.

There is no way that either author will receive adequate payment for the effort they have expended in developing these programs.

Will the ultimate weaving program be written? The market for draw-down and analysis programs is insignificant compared with that of video games or book-keeping programs. Yet, there was a drawdown program for the APPLE II within a year of its introduction when it was the only home computer with sufficient graphics capability for weaving design. To increase the market, future designers of programs for weavers will have to use computer languages that are readily transportable to a wide variety of



computers. While not optimized with machine-language routines that increase the computational and display speed, the potential market and lifetime of a program that can run on many computers, both present and future, would be large enough to induce some programmer to regard weaving programs as other than a labor of love.

Availability of products reviewed in this article: "The Weaver", Compucrafts, RFD 2, Box 216, Lincoln, MA 01773; "Navette" opcode software, 1909 1/2 Vine Street, Berkeley, CA 94709.

### SOFT CLOTHING YARN IN NATURAL COLORS

Wilde Yarns, 3705 Main St., Philadelphia, PA 19127, offers a soft clothing yarn in 8 natural colors. The 2 ply yarn comes in 1 lb. cones and yields approximately 1440 yds/lb. It is suitable for warp and weft and also for knitting. The 4 ply yarn comes in 4 oz skeins and is a great knitting yarn. The choice of colors is very large, both in the greys and in the browns and ranges from white to a very dark warm brown.

In order to test the yarns, we wove a lap robe which could as easily be a shawl, a light blanket or fabric for a poncho. The sett of

10 epi seemed ideal for tabby and for loosely woven twills. For a twill fabric that needs tailoring, a set of 12 epi would be preferred. For the description of the blanket, see pp. 00. The project, using 5 of the available colors proves that natural colors need not be drab. All shades combine easily into vibrant and exciting color harmonies. The weaving and finishing are done with ease. The fabric is very washable and the desired amount of fulling is easy to control by the temperature and amount of agitation during the first washing. The fabric can be brushed in order to increase the softness of the surface. The yarn is very suited for garments and blankets, but could easily be called an all-purpose yarn because of its great versatility. ■

## PRODUCT NEWS

**ANDEAN YARNS, INC.**, 54 Industrial Way, Wilmington, MA 01887 (617) 657-7680, is offering a wonderful selection of 3 ply alpaca yarns in 12 natural shades, 3 tweeds, and 16 dyed shades. They are available in 1.75 ounce (50 gram) skeins (200 yds), or in 2.2 lb (1 kilo) cones (4,000 yds). Natural and tweed shades are \$4.00 per skein; \$72.00 per cone. Dyed shades are \$4.60 per skein; \$80.00 per cone.

They are also offering plant-dyed worsted wool singles size 2, in 12 shades. These Peruvian yarns are sold for \$3.00 per skein. There are 110 yds per 1.75 ounce (50 gram) skein.

Now these yarns are available at your favorite yarn store or by mail order at Dragonfly Studio, P.O. Box 482, Lafayette, CO 80026 (303) 665-9504.



**HARRISVILLE DESIGNS**, Harrisville, N.H. 03450, is announcing the availability of two new floor looms that incorporate a six treadle floating lamm system into their original 22" and 36" looms. The new looms, Model A/6 and T/6, use the convenient "snap chain" tie-up and can be folded with both the warp and tie-ups intact. The looms are sold as complete kits and have suggested retail prices of \$298, for the 22" Model A/6 and \$404, for the 36" Model T/6.

For those weavers who have purchased four treadle, direct tie-up Harrisville looms since 1972 and who would like to take advantage of the multiple tie-up option, they are offering a "Tie-Up Conversion Kit."

**MIDMARCH ASSOCIATES**, Box 3304, Grand Central Station, New York, New York, 10017, (212) 666-6990, has just made available the new *Guide to Women's Art Organizations and Directory for the Arts*. Its a 174 page book full of useful information for artists, lavishly illustrated with unique photographs of the groups. Some of the subjects covered are multi-arts centers, organization, galleries, groups, activities, networks, publications, archives, slide registries, emergency funds, artists' colonies, grants and fellowships, art business, resource and information agencies. The list price is \$8.50.

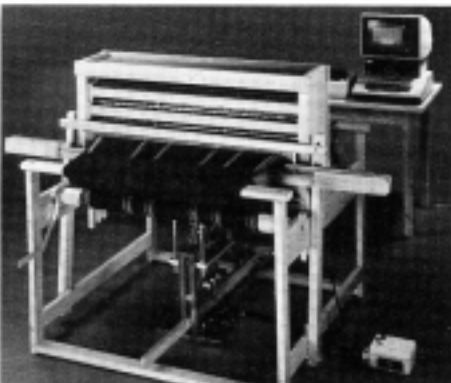

**SEGARD LOOMS**, 9 St Quirace pl., 77160 Provins, France is producing a loom with electronic dobby (loom controlled shedding mechanism) for domestic use (France) and for export. The system interfaces with the Apple II or with ZX81. The loom weaves 39" (100 cm) wide and comes with either 8 or 16 shafts. The cost for the loom plus electronic dobby is 9,043.75 F. Fr and 11,243.75 F. Fr, depending on the number of shafts. The interface card and program are extra. The same looms can also be purchased with the standard treadle and tie-up system.

**LOUISIANA CRAFTS COUNCIL**, 7214 St. Charles Ave. #922, New Orleans, LA 70118, publishes a quarterly tabloid called *The Louisiana Crafts Report*. The organization has recently expanded the publication, which covers crafts in Louisiana in particular, although not exclusively. The quarterly is mailed to all members for an annual membership fee of \$15.00. A subscription only may be had by sending \$8.00 with your name, address, and zip code to the Louisiana Crafts Council.



**AVL LOOMS, INC.**, 601 Orange Street, Chico, California 95926, (916) 893-4915 or AVL Looms Europe Ltd., P.O. Box 36 Macclesfield, Cheshire SK10 2QE, United Kingdom, announce the introduction of a new loom—the 40" Basic Modular. This new loom comes equipped with 4 shafts and 6 treadles and uses the same loom body found on AVL's 40" dobby loom.

Any number of shafts up to 16 may be added as well as the AVL dobby head, fly-shuttle beater, and virtually all other AVL optional weaving equipment.

The 40" Basic Loom is built with kiln-dried maple hardwood. It is constructed so that the back can be pivoted forward without effecting the warp. When not in use, the loom may be passed through any standard doorway for ease of storage.

**GEMPUBLICATIONS**, P.O. Box 2499, Melbourne, FL 32901, is offering a universal pattern. This is an item for the handweaver who enjoys designing handwoven clothing. The instructions are very clear. Once you have followed the directions, you have a muslin pattern of bodice, sleeves, and skirt that will fit your body size perfectly.

**FLYNNS**, 1154 Howard Street, San Francisco, CA 94103, (415) 621-5968, makes available everything that is needed for dyeing and painting fabric. FLYNNS COTTON DYE (also dyes rayon and linen) is noted for brilliant colors and extremely high washfastness. A cloth color chart of all 50 colors is available on request. Flynns also sells COLOR EASY, an all purpose hot water dye and DEKA fabric paint and silk-screen ink. ■

# IN MY COUNTRY, IT'S WINTER

by Agathe Gagné-  
Collard

translated by Clotilde Barrett

It is difficult for me to break with the weaving traditions of my ancestors for the sake of enhancing the evolution of the craft. When I teach as well as when I design, I always seek to compromise in order to respect the value of both tradition and growth. Thus, when I agreed to take on the task of preparing a monograph *Boutonné d'hier et d'aujourd'hui (Boutonné of yesterday and today)*, published by *Tisserands-Createurs de Quebec*, there was not only the desire to put into writing a tradition that has been passed along only by word of mouth, and that was about to disappear, but there was also the intention of using the creativity of our ancestors as an inspiration for contemporary interpretations (ed: *See book reviews p. 64*).

I wove a coat to illustrate my point. It is a garment that is fashionable today. The colors are reminiscent of the darkening November evenings as I experienced them in Charlevoix, my native region in the province of Quebec.



Yves Tessier

I want to share its warmth, comfort and the feeling of well being which it has captured.

The weave structured is a two-tie unit weave related to Summer and Winter. As in *double Summer and Winter*, the pattern design progresses by half units.

Notice that the design is elongated.

This is done intentionally in order to achieve a stronger vertical effect which is more flattering for my type of figure.

The threading is very much inspired by *The Weaver's Journal*, April 1979, Vol III, #14, issue 12, p. 30, Fig. 6. Mine is a 10-pointed star instead of an 8-pointed one.

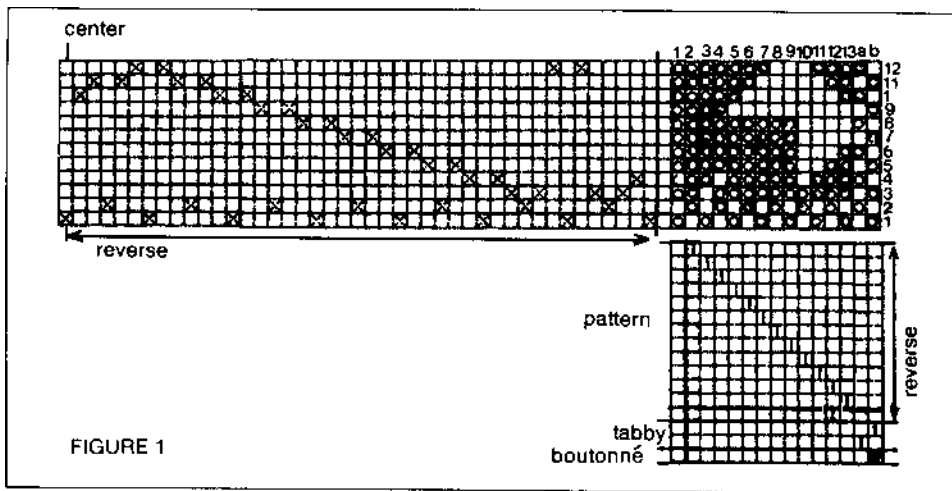

FIGURE 1

**Warp:** singles wool in blue. 1.8 kg includes the tabby weft.

**Weft:**

**tabby:** same as warp

**pattern:** 2 ply wool worsted, colors blue and green. 11 50 gr skeins of each is enough to weave also the boutonné motif on the neck tie.

**Reed:** 15 dent (30/10)

**Sett:** 15 epi

**Yardage required:** 184" (4.6 m) x 46" (1.15 m) for the coat; 92" (2.3 m) x 10" (.25 m) for the neck tie

**Threading, tie-up and treadling:** See Fig. 1. Alternate a tabby pick and a pattern pick. For the pattern picks, alternate a blue pick and a green pick. Repeat each pattern treadle shown in Fig. 1 three times.

With a 12-shaft loom it is rather easy to weave a star. Yet, the motif

that harks back to my grandmother's weaving is an 8-point star done on a 2-shaft loom with boutoné. This technique is finger manipulated and is used for the neck tie of the coat. It is superimposed onto the pattern weave which is loom controlled.

The boutoné, which is achieved by pulling up loops of a pattern weft, is accomplished by inserting a supplementary pattern weft in the tabby shed which lifts shafts 1, 3, 5, 7, 9, 11. The loops are pulled up at regular intervals according to the motif of the 8-point star.

The trim, 292" (9 m) long, was knitted in the following way: cast on 7 stitches; for the first row, knit 3 stitches, slip one, knit 3 stitches; for the second row, purl 7 stitches. Repeat these two rows. The slip stitch allows the trim to be folded easily.

I am pleased to share with you some warmth and comfort for the long nights ahead, the bitter cold. ■

**Ask us for samples of our specialty yarns for home and industry.**

- Rug Wools in many colors.
- Tremendous assortment of Synthetic Yarns.
- Novelty Yarns including nubby earthtones.
- 100% Cotton Yarns galore.

*If it can be spun, we're the one.*

**Wonder Craft**  
DIVISION OF RUBIN RUG INCORPORATED  
1 Constitution Street, Bristol, RI 02809  
Tel: (401) 253-2030

Send \$1.00 for samples and a spot on our mailing list.

**Sievers**

**School of Fiber Arts**  
on beautiful Washington Island, Wisconsin

*Summer oriented*  
From June 1 to October 31st

**48 classes—28 teachers**

Weaving, Spinning, Natural Dyeing, Quilting, Basketry, Batik, Silk Screen Printing, Off-Loom Weaving and more with special attention to the beginner.

**Attractive discount** on famous Sievers Looms and Spinning Wheels while here as a student.

Classes fill rapidly so early registration is suggested.

**Write today!**  
Walnut Hill, Washington Island, WI 54246



# MULTISHAFT OVERSHOT ON OPPOSITES

by Madelyn van der Hoogt



Jim Curley

where half tones appear; the half tones become a part of the design process.

A warp block will be defined as a block where the pattern weft floats underneath. The block appears as plain weave on the face of the cloth.

A weft block will be defined as a block where the pattern weft floats on the surface.

A half tone block is a block in which the pattern weft weaves over and under the warp threads, as in tabby. The pattern weft appears as specks on both sides of the cloth.

In overshot, the blocks "woven" are the blocks whose shafts are lowered (weft blocks), since the weft covers those warp threads to make the pattern.

When a warp pattern block appears adjacent to a weft pattern block, there is greater contrast between pattern and background. Such a weft block is square in shape and is undistorted by the pattern weft and tabby entering a half-tone area.

In four-shaft overshot the half-tones form 50% of the weave surface. With more shafts and more blocks on opposites the number of half tone blocks can be reduced, the only limiting factor being the length of the float on the reverse of the fabric.

For my first ten shaft coverlet I selected a five block (on opposites) threading draft from *Keep Me Warm One Night*, #354, p. 260. Because I like the sharper look of finely sett overshot, I doubled the epi (24 to 48) and to maintain the size of the design, also the number of threads in each block. Another advantage of overshot on opposites is that a profile draft can be used for designing and threading; in mine, because of the fine sett, each ■ represents four threads, (in block A, ■ = 1-2-1-2-; in B, ■ = 3-4-3-4-, etc.). See Fig. 1.

1. Ten-shaft coverlet created by Madelyn van der Hoogt

With one weaving lesson under my belt, a new/used four shaft loom, Mary Meigs Atwater's book, and unbridled confidence, I set out to weave a *piece de resistance*, a double weave coverlet of snowballs and pine trees. What followed was the kind of collision with reality that in weaving so often opens a new door. Those were profile drafts not threading drafts in Atwater's book, I learned, and so I turned, reluctantly at first, to the overshot I could produce on my four shaft loom. With growing interest I wove several overshot coverlets before visions of something "more" led to a new loom and the study of multi-shaft, culminating in the coverlet pictured here (Photo 1).

Traditional four shaft overshot is

threaded either as four blocks in twill sequence (1-2, 2-3, 3-4, 4-1) where half-tone blocks appear adjacent to every weft pattern block; as two blocks on opposites (1-2, 3-4) with no half-tone blocks i.e., Monk's Belt; or as four blocks consisting of two opposite pairs (1-2, 3-4 and 2-3, 4-1) with large areas of half tones. It is this last method which will be extended to multi-shaft overshot. As shafts are added, so are the design possibilities.

Since one of my personal aesthetic objections to four-shaft overshot is the adjacent half-tones caused by blocks sharing threads, I am especially drawn to threadings on opposites. These threadings allow the weaver to select the blocks

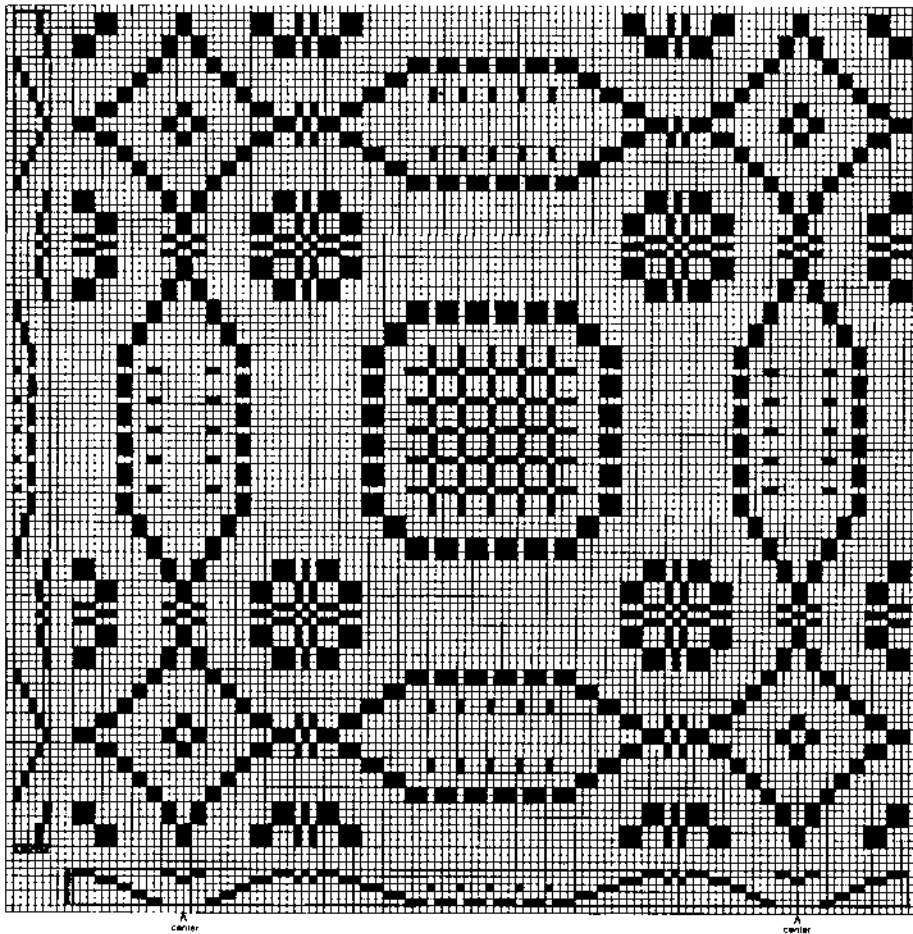
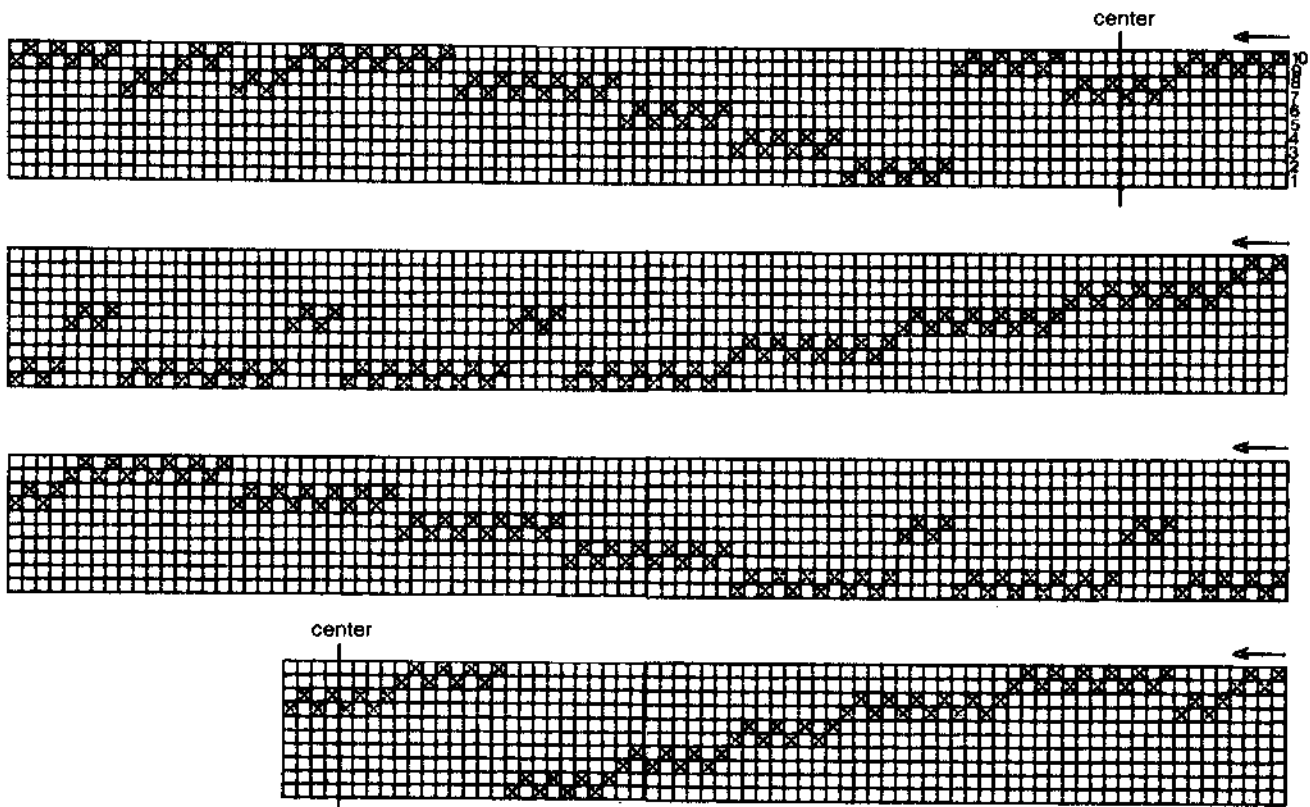
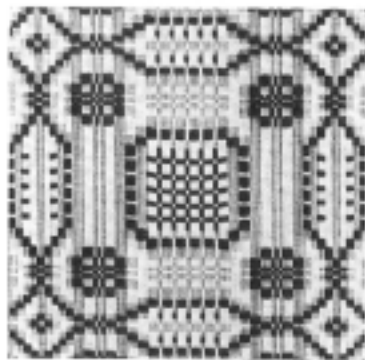

FIGURE 1. Profile of weave draft



Thread by thread draft, one repeat from center to center



2a. front



back



FIGURE 2a. Tie-ups

X = sinkers  
O = risers

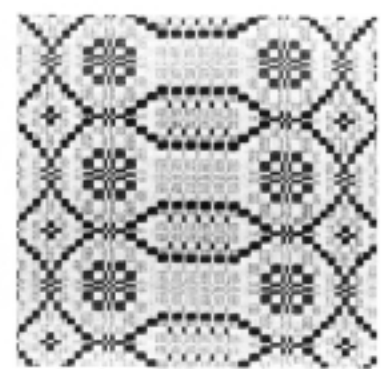

3a. Border sample



2b. front

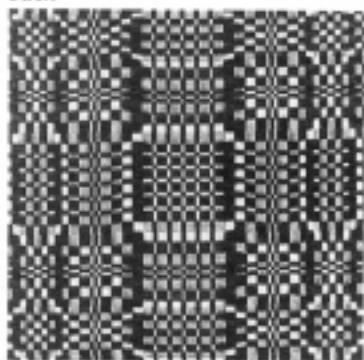

back



FIGURE 2b

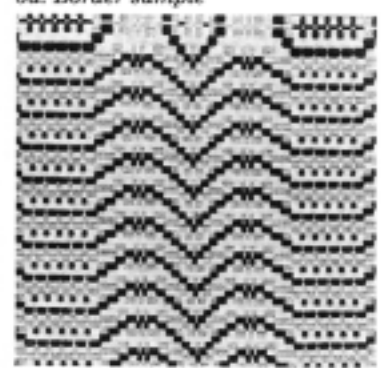

3b. Border sample



2c. front

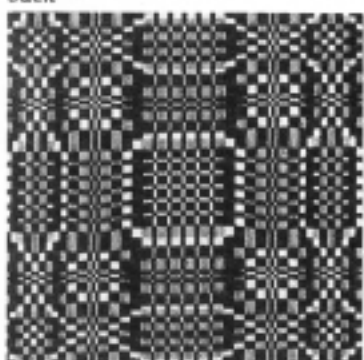

back

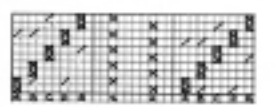
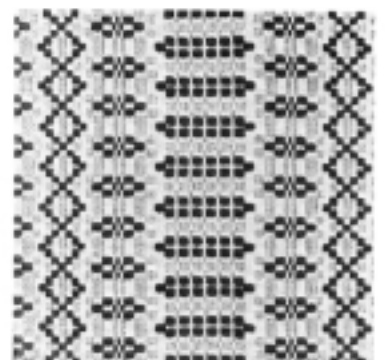
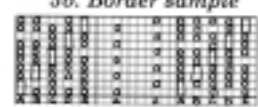
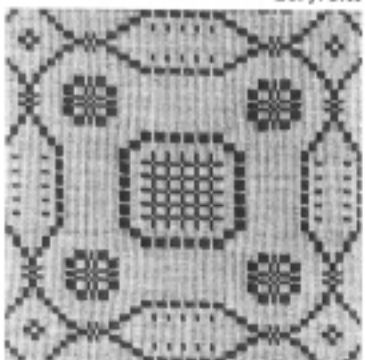

FIGURE 2c



3c. Border sample



2d. front

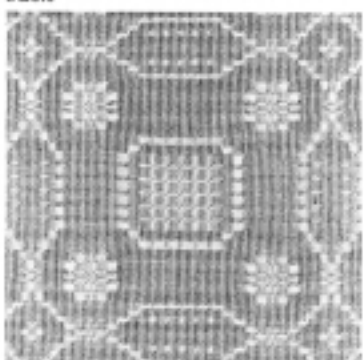

back

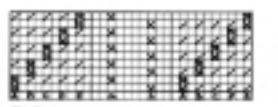
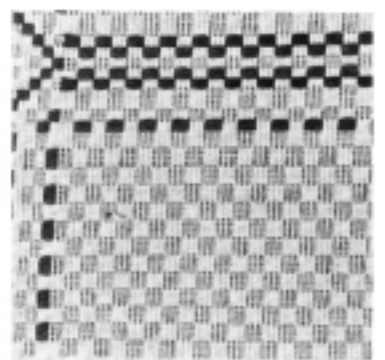
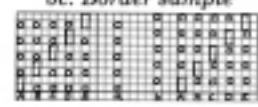
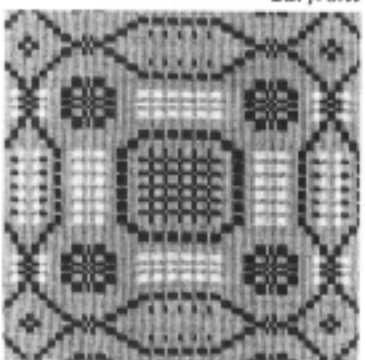

FIGURE 2d



4. Corner containing only half-tones



2e. front

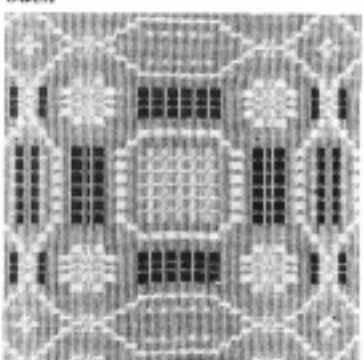

back

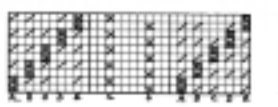
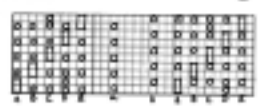

FIGURE 2e



The weaver of the coverlet pictured in *Keep Me Warm One Night* wove each treading block by weaving one or two warp blocks (both shafts of the block up), a weft block (both shafts of the block down) and tied each pattern weft by means of stitching ties in two other blocks (one shaft of the block up, the other down) (Fig. 2a, Photo 2a). At least one of these blocks is adjacent to the weft pattern block. I changed the tied up so that warp pattern blocks always abut weft pattern blocks on both sides. This is possible with every block except B(3-4), where, to avoid a very long float on the back, I had to use a stitching tie from 1-2 in addition to one from 7-8 (Fig. 2b, Photo 2b). In the other four blocks only one stitching tie is used with each pattern row. Thus for each pattern row a shot that covers one block, i.e., 1-2, goes under three of the other threaded blocks (3-4, 5-6, 9-10) and weaves as tabby (half tone) in one block (7-8). No float on the reverse of the fabric covers more than two blocks in succession so that all floats are under  $\frac{1}{2}$ " in length. A simplified representation is shown in Fig. 3.

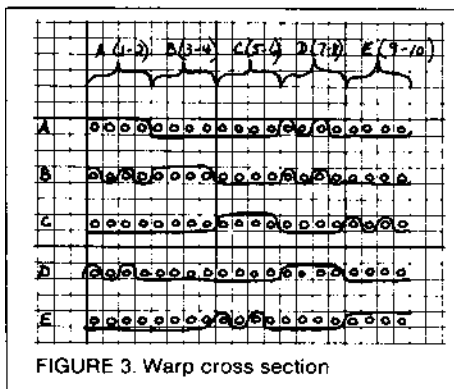

FIGURE 3. Warp cross section

I wove several coverlets on this threading varying the treading and borders (Fig. 4, Photos 3a-c). I found that a good method of designing borders was to first thread the main field and treadle potential border designs, knowing that any design I could treadle on that threading could be "turned" and threaded where it would appear as the side border when the field design was treadled. This is valid only when the design is woven as the blocks are drawn in.

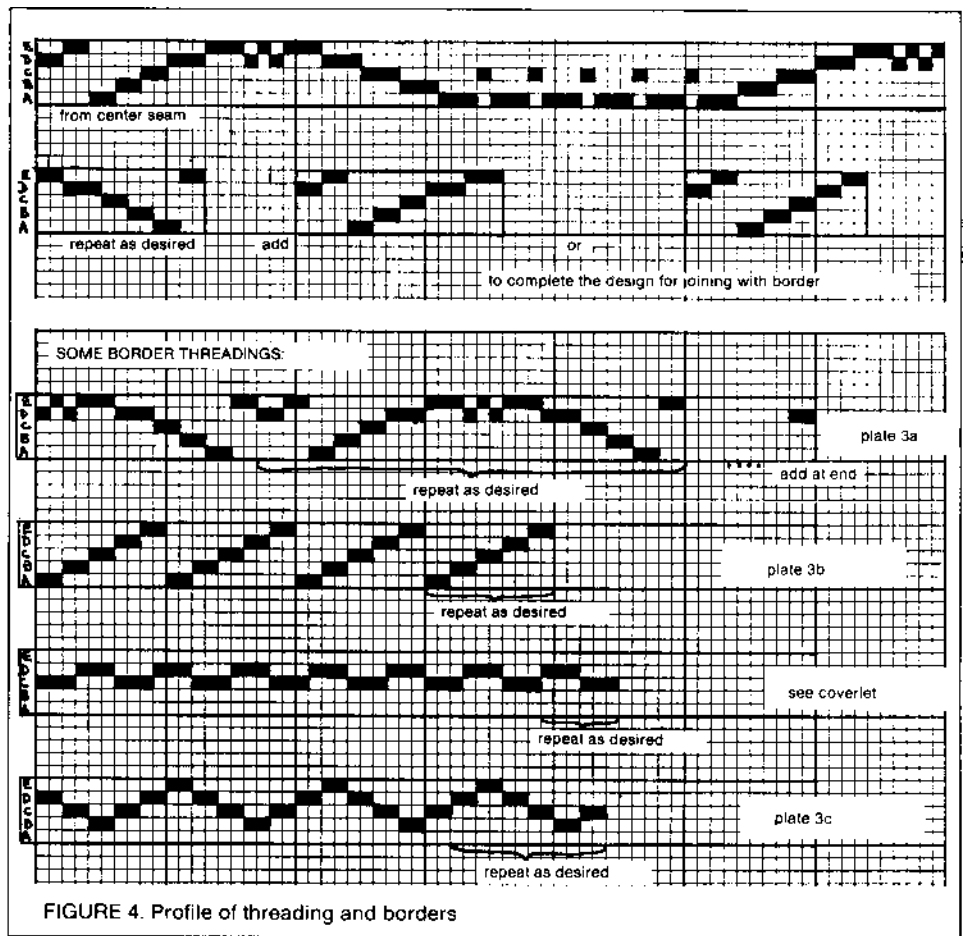

FIGURE 4. Profile of threading and borders

On my draft which is treadled "rose fashion" (Fig. 1) that meant, that any time I treadled the A(1-2) block as part of my "bottom" and "top" borders, the corresponding block threaded at the side would be C(5-6). B(3-4) remains B(3-4), C(5-6) becomes A(1-2), D(7-8) becomes E(9-10), and E(9-10) becomes D(7-8).

I particularly liked the effect achieved by simply alternating two blocks A(1-2) and E(9-10), which were threaded for the side border as C(5-6) and D(7-8) (Fig. 4, border 3). Usually in border threadings the corner design (where border threading and border treading intersect) is very pleasing. In this case, however, when I treadled A and then E, the corner contained only half tones since those blocks carried a stitching in 7-8 and 5-6 respectively (Photo 4). To get a more interesting corner, I first treadled 5-6 for the corner, removed the shuttle and treadled 1-2 for the rest of the threading, reversing the process from the other direction. After completing all the picks for that

block, I then treadled 7-8 for the corner, removed the shuttle and changed the treading to 9-10 to complete the row.

The checkerboard that resulted in the corner gave me the idea of using a pick-up stick to date and initial the coverlet. After planning the design on graph paper (Fig. 5) I

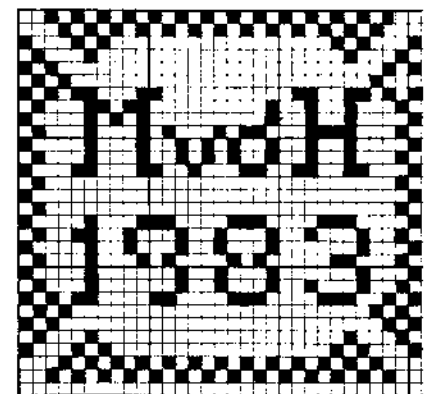

FIGURE 5. Pick-up plan

wove it by lowering the threads (treading 5-6 or 7-8) where I wanted a weft pattern block to appear, picking up four threads in between any adjacent blocks so as to break the pattern float

on opposites by drafting alternating blocks or intermittent stitching ties to avoid long floats (see Zielinski). When one thinks also of using the tie up (ie., placement of warp and half tone blocks) as a designing tool, additional shafts add even more potential for design and texture.

### COVERLET

**Warp:** 20/2 unbleached cotton (Borgs of Lund).

#### Weft

**tabby:** same as warp (warp and weft needed 4 lbs)

**pattern:** 3/16 wool worsted, teal blue, 3 lbs (Nehalem); singles wool, rust, 3 lbs (Harrisville).

**Fringe:** same as pattern weft, knotted to the edge of the coverlet on all four sides after the coverlet was removed from the loom.

**Sett:** 48 epi. (190/10 cm) The coverlet was woven on a Glimákra 10 shaft countermarche loom which provided the firm beat necessary to square the design with such a close sett.

**Width in reed:** 51.4", 4 ends percent in 12 dent reed

**Total ends:** 2466

**Finished size:** 48" (122 cm) x two panels = 96" (243 cm) x 120" (304 cm). The two panels were joined with a figure eight stitch edge to edge.

**Pattern source:** *Keep Me Warm One Night* #354, p. 260

#### Bibliography

- Burnham, Dorothy K. and Burnham, Harold B., *Keep Me Warm One Night*, University of Toronto, 1972, p. 260.  
Zielinski, S. A. *Master Weaver Library*, Volume 7, Robert LeClerc, Ottawa, 1980, pp. 66-74.

**ABOUT THE AUTHOR:** Madelyn van der Hoogt has been weaving for three years with a primary interest in coverlets. Her first ten-shaft coverlet received Judges' Choice at Midwest '82, and the most recent (pictured here) Best Craftsmanship, Best Use of Overshot, and Peoples' Choice at Midwest '83. She is presently offering a workshop in weaving and finishing coverlets at The Weavers' Store in Columbia, Missouri. ■



5. Initials and date woven by pick-up

(56565656565656787878787878) and otherwise allowing the half tones to appear as background (by treading 1-2 and 9-10). (Photo 5).

The variety of effects made possible by changing the tie up with overshot on opposites invites further exploration. Zielinski suggests in *Master Weaver* that the half tones can be dimmed by using two treadles for each pattern block, ie., 7-8 tied to 1 and 7-8 tied to 2. When woven in succession with the corresponding tabby (7-8-1, then odd tabby, then 7-8-2, then even tabby) the half tones should look like plain weave rather than the usual slightly irregular grid (compare Fig. 2b, Photo 2b with Fig. 2c, Photo 2c). Because my sett was so close, the separation between every 4 threads caused by the reed altered the effect; in a coarser sett the resulting difference would be much more significant.

Extending Zielinski's tie-up idea, one could tie pattern blocks to two successive ties in all the other blocks, producing overshot on a solid plain weave (half tone) background (ie., weave 7-8-1-3-5, then odd tabby, then 7-8-2-4-6, then even tabby (Fig. 2d, Photo 2d). This produces a very stable fabric and in closely related colors would have some of the pattern qualities of damask while requiring only two shafts per block. One could also use rare warp pattern blocks as parts of the design so that they stand out in the plain weave field with the weft pattern blocks (Fig. 2e, Photo 2e).

The possibilities only begin here. With more shafts than the ten I used, more complex designs can be adapted. Many of the six block designs usually reserved for doubleweave or Summer and Winter can be made suitable for overshot



# SHADOW WEAVE VEST

Jan Carter



The strong visual impact of shadow weave has been executed with expertise in this stunning piece. As your eye travels the graceful pattern of the weave, swaying to and fro, and the gentle outline of the shape of the vest, you see continual flowing movement. This is an intriguing project, with optical illusion created by color and weave effects that are challenging.

For May Frank, a member of the Handweavers Guild of Sun City, the fabric was the culmination of a year's work with a study group on shadow weave. They produced one piece a month, experimenting on their own looms, and then coming together to share their experiences. Clotilde Barrett's monograph on shadow weave\* was used as the text. The fabric was woven on her 40" Gilmore loom.

**Warp:** 2/16 wool worsted in two shades of green, light and dark. (Willamette from Oregon Worsted Co.)

**Weft:** Same

**Sett:** 30 epi (120/10 cm) in a 15 dent reed

**Width in the reed:** 27" (68.5 cm)

**Length of the warp:** 2½ yds (2.3 m)

**Selvages:** double the last 5 warp threads on each side

**Threading, tie-up, and treadling:** 8 shaft undulating twill draft on page 10 of *Shadow Weave and Corkscrew Weave*, by Clotilde Barrett. See Fig. 1. Repeat the threading 5 times, then the reversed threading 5 times.

**Total number of ends:** 800 + 10 (selvage reinforcement) = 810 ends

\*Barrett, Clotilde, *Shadow Weave and Corkscrew Weave*, Colorado Fiber Center, Inc., P.O. Box 2049, Boulder, CO, 80306, 1980.

Shadow weave vest designed by May Frank

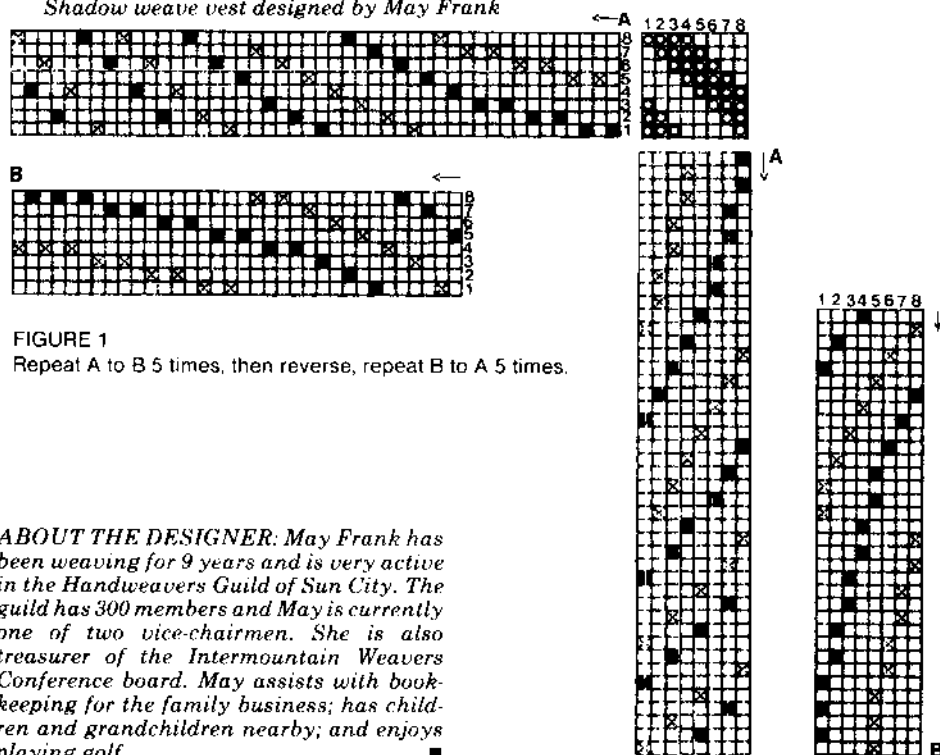
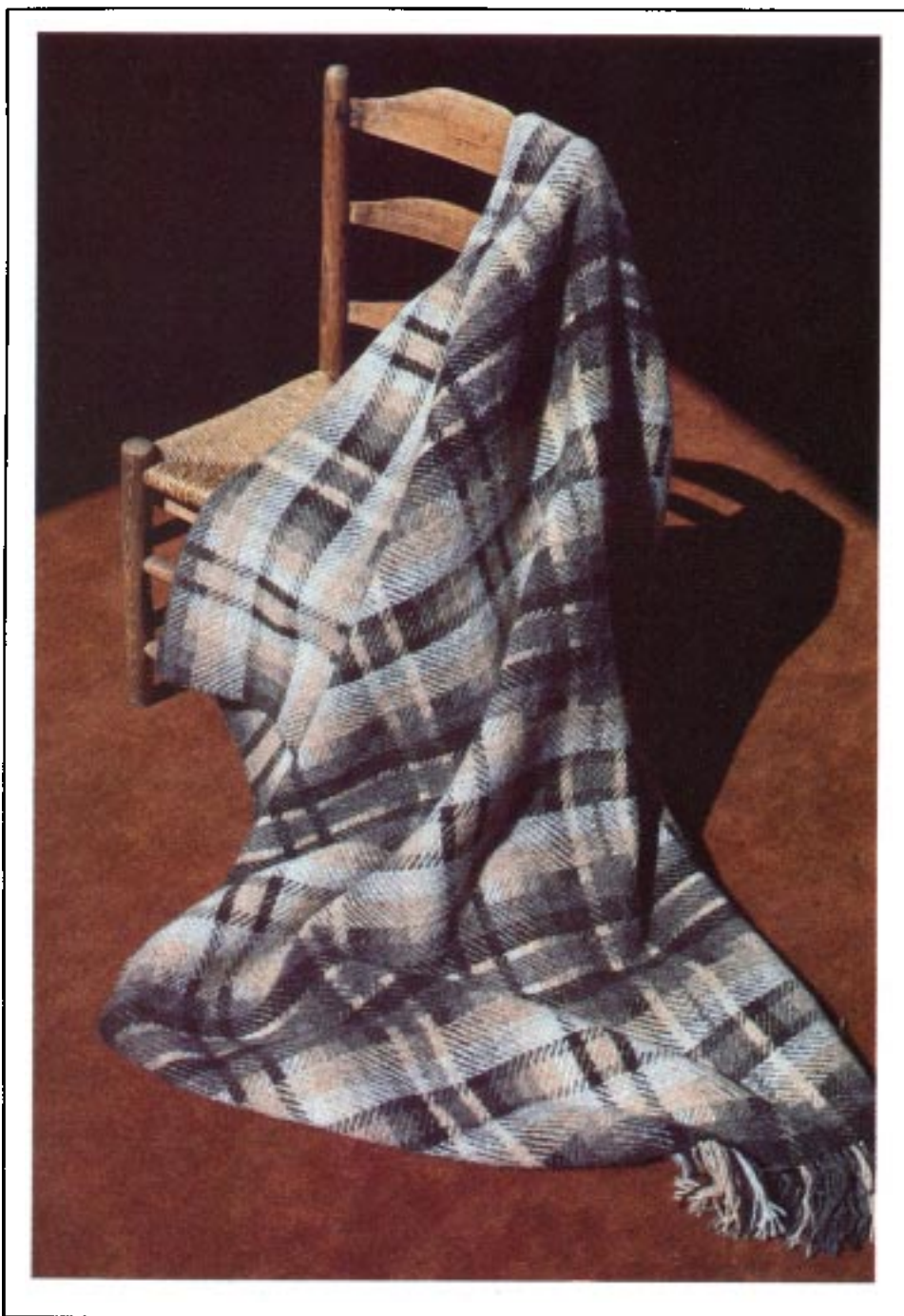

FIGURE 1  
Repeat A to B 5 times, then reverse, repeat B to A 5 times.

**ABOUT THE DESIGNER:** May Frank has been weaving for 9 years and is very active in the Handweavers Guild of Sun City. The guild has 300 members and May is currently one of two vice-chairmen. She is also treasurer of the Intermountain Weavers Conference board. May assists with book-keeping for the family business; has children and grandchildren nearby; and enjoys playing golf.

# THE VERSATILITY OF FOUR-SHAFT TWILL



*Designed and woven by Elizabeth Kolling-Summers*

A 4-shaft twill in its simplest form is threaded on a straight draw shaft 1, 2, 3, 4, 1, 2, 3, 4, etc. Even then, the weaver has interesting choices. The fabric can be balanced. This is a reversible fabric in which warp and weft show up in equal amounts on both sides. The twill is referred to as  $\frac{2}{2}$  and each weft pick goes over two warp ends,

under two, etc. The fabric can be woven in a warp twill. More warp shows on the face, more weft shows on the reverse side. In this  $\frac{1}{1}$  twill, each weft pick goes over 1 warp end, under three, etc. The fabric can also be woven in a weft twill. More weft shows on the face, more warp shows on the reverse side. In this  $\frac{1}{3}$  twill, each weft pick goes over 3

warp ends, under one, etc.

Our blanket combines bands of warp twill and bands of weft twill. These weave structures allow the weaver to make strong color statements. The colors in the warp are arranged in stripes. These stripes will show loud and clear in the warp twill area and fade away in the weft twill areas.

On the other hand, the colors of the weft will be dominant in the weft twill areas. In order to create a design that is exciting on both sides of the fabric, the weft colors have to be picked carefully, even when they do not show much on the face of the fabric. In these bands ( $\frac{1}{1}$  twill) the weft colors appear on the reverse side.

The yarns for the project are a 2 ply wool (1440 yds. or 1316.7 m/lb) from Wilde yarns. (For a description, see Product Reviews, p. 73). Five natural colors were used, ranging from light gray to dark brown: mist, clay, smoke, bark, loam.



# New Glimåkra looms.



A brand new selection, of the highest Swedish quality and craftsmanship. *Viking*—a jack loom especially designed for the American weaver. *Susanna*—a rigid heddle loom available in 1984. *Sara*—our large weaving frame. And *Regina*—the Glimåkra tapestry loom with treadles and beater.

In addition, we carry the full line of Borgs' famous, top quality wools, cottons, linens and cottolins (50% cotton/50% linen), including a new 2/2 cotton yarn for weaving and knitting.

We also stock America's largest selection of Swedish weaving books and the new *Treasure Chest of Swedish Weaving*.

Our products are sold all over the country through a network of the best weaving and yarns stores. Ask yours today for a Glimåkra loom demonstration and let them show you our weaving books and sample cards of over 1000 Borgs color samples, too. Or call toll free 1-800-THE-YARN. And discover the pleasure of weaving with the best.

Glimåkra is just one of the many Swedish companies pledged to the Swedish tradition of excellence. A tradition you can see in the way we do business, in the way we live and in our unspoiled landscape of mountains, forests and sparkling lakes.

Get close to the Scandinavian magic of Sweden. Our products, our people, our land. Come be our guest.



**Sweden.**  
**Where innovation**  
**is more than just a tradition.**

Glimåkra Looms'n Yarns, Inc. P.O. Box 16157, Rocky River, OH 44116. 216-333-7595. Western Division: P.O. Box 1271, Sonoma, CA 95476. 707-938-8229.

Please send detailed information on Swedish vacation options.

Name: \_\_\_\_\_

Address: \_\_\_\_\_

Cut out and mail this coupon to  
the Swedish Tourist Board,  
75 Rockefeller Plaza, New York, N.Y. 10019

Glimåkra

# COUNTERMARCHE: PURE AND SIMPLE

by Joanne Tallarovic

It was around Christmas of my sophomore year at the Cleveland Institute of Art when I happened to walk into the Weaving Department with a friend. I was immediately stunned. All those looms and equipment! I walked through the room in a daze and into the graduate room where the teacher, Brita Sjoman, was weaving a tubular gown for Bonwit Teller of New York. I watched her for a few minutes and asked "What are you doing?" She answered "I'm weaving, of course!" In essence I must have responded, "Well, when I grow up I want to be just like you." I went straight to the office and changed my major. It was a day that has certainly changed my life.

Since that time I devoted my career to weaving. After five years I received a B. F. A. Degree in Weaving and Textile Design from the Cleveland Institute of Art. During those years I worked entirely on countermarche looms. There were other looms in the department, but those were used mostly by evening and part time students. I didn't realize for years how fortunate I was. Brita had the deepest appreciation and respect for equipment and taught her students the same. She laid a very traditional foundation for the art of weaving that would be hard to equal.

In order to teach us how the countermarche loom worked and how to solve problems when they occurred, Brita would "booger-up" a loom and then call on us as a group to discuss the problem and then find the correct cure. It was a great way to learn to understand the countermarche system and a method I use with students today. I find that most weavers do not know the workings of their own loom; I mean the fine tuning of components to make the loom work in the most efficient way. You should know your loom intimately, know what

every part is for, what it controls, how to improve a shed, how to adjust, how to troubleshoot. That's what this article is all about.

I have woven on countermarche looms for 20 years. In that long

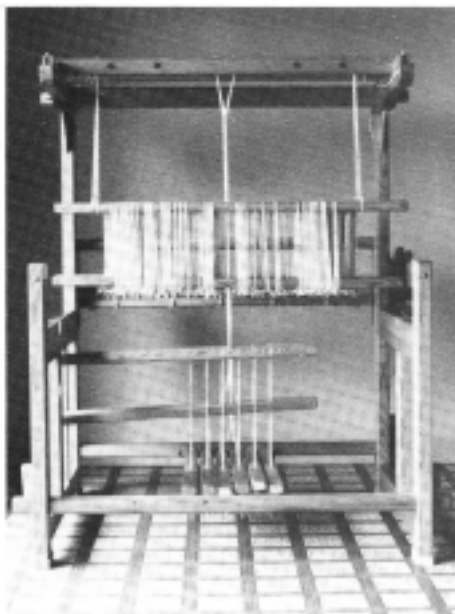

1. Countermarche loom with cloth, knee and breast beams removed to show the correct position of lams and treadles.

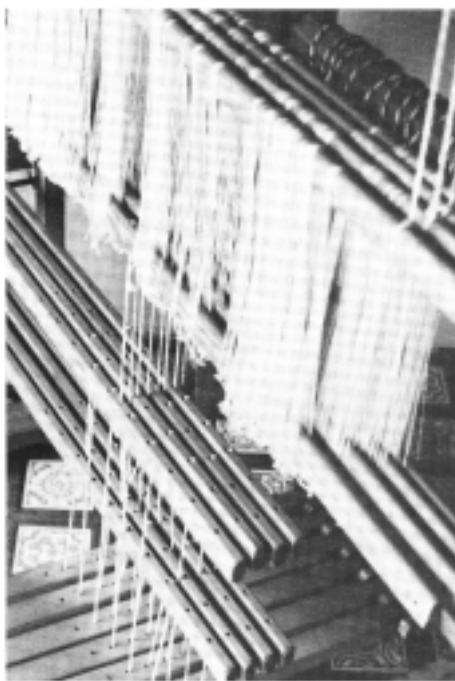

2. Countermarche loom with completed tie-up; correct alignment of shafts and lams.

time I have analyzed and re-analyzed the system and tried to determine, in the purest sense, just what countermarche is, how it works and why.

The word countermarche comes from the French. It can be spelled in many different ways, Contre, Kontra, Countre, Countra, etc. COUNTER means to move in the opposite direction. MARCHE means the same as a treading. Most looms have lams. In a counter balance or a jack loom there is one set of lams that either raise or lower the shafts. In the countermarche loom another set of lams is added. Both sets move in the opposite direction.

Each shaft has its own upper lam, lower lam, and set of jacks which pivot at the top of the loom. Each shaft operates independently of the other shafts. If, for instance, you have tied the first shaft to rise (lower lam of the shaft is tied to a treadle) and then step on the treadle, the upper lam goes up (remember the shaft and upper lam act as one) and the lower lam goes down. They move in opposite directions. See Fig. 1. If the first shaft had been tied to fall (upper lam of the shaft is tied to the treadle) and the treadle depressed, the shaft and upper lam would fall and the lower lam would rise. They move toward each other. Each and every shaft is tied to either rise or fall according to which of its lams is tied to the treadle. When you begin to weave, all that is necessary is to step on the treadle. Some shafts will rise, the others will fall.

Assuming that the loom is assembled, and the locking pins in place, start at the top of the loom and work your way down, making adjustments for maximum efficiency. It is very important that before you attempt to make adjustments on any cord or to change

a tie-up, the locking pins are placed in the jacks at the top of the loom. These pins stabilize the jacks and prevent any up or down movement of the shafts and lams. After adjustments or tie-up changes are complete, remove the locking pins and weave.

The shafts should be positioned so that a warp thread passes through the middle or lower part of the heddle eye. To do this, tie a string around the warp beam and pass it over the back beam, through a heddle, over the breast beam and tie it to the front foot rail. Check the position by eye from the side of the loom.

Now, measure the distance between the bottom of the shafts and the floor. This distance will be roughly divided into four sections: section 1 is the space between the bottom of the shafts and the top lam; section 2 is the space between the top lam and the lower lam; section 3 is the space between the lower lam and the treadle and section 4 is the space between the treadle and the floor. If these spaces are equal, the shafts and the lams have the greatest and most equal "travel distance" during the weaving process. If one of these spaces is cropped, the "travel dis-

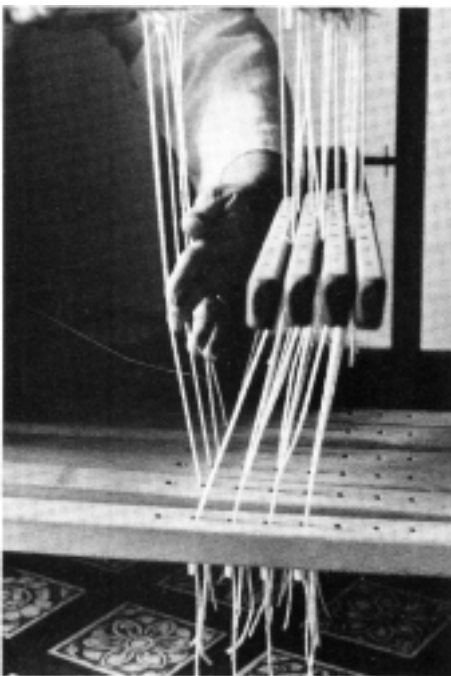

3. Checking to be sure that all cords are straight from the lam to the treadle.

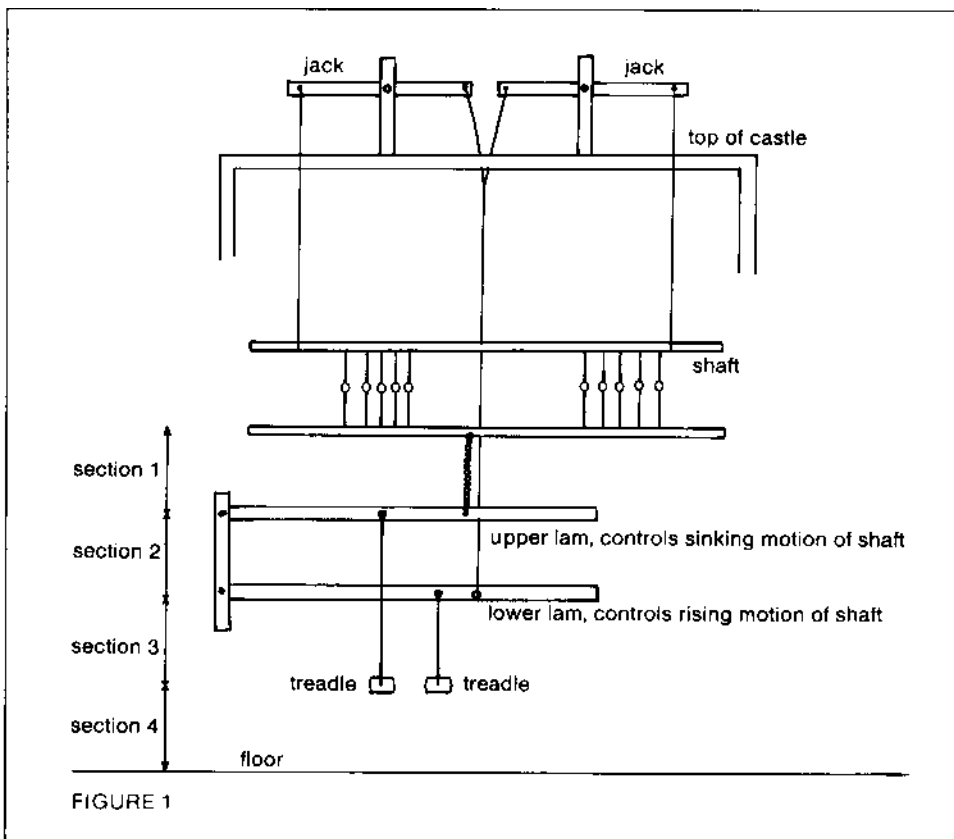

stance" is limited and the action of the loom is hampered. When tying the lams, the open end or free end should be about 1 to 1½" higher than the hinged end.

The most common problem in tying a counter-marche loom is that weavers tie the treadles too high. They should be nearly level when tied correctly. If treadles are too high they immediately make contact with the lower lams and the action is hampered.

Now, I want to talk about the actual tie-up and cording system of a counter-marche loom. Tie-up drafts for different types of looms may be written in the following ways:

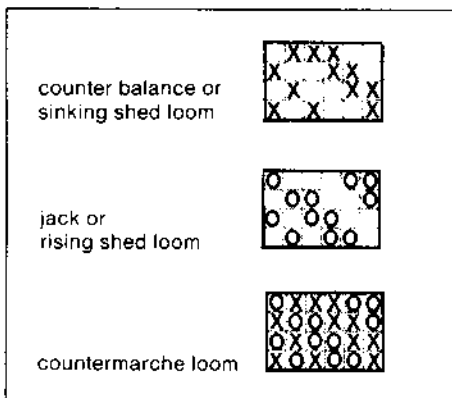

If you want to tie up a counter-marche loom with either of the first two drafts, put the opposite symbol in the blank spaces and you have the tie-up for a counter-marche loom.

If you have trouble remembering which lams raise or lower the shafts put an X on the upper lam and an O on the lower lam with a pen or pencil. Remember it is the upper lam which lowers the shaft and the lower lam which raises the shaft. Or just remember the saying "Bottoms Up" or "Tops Down". The upper lam is always connected directly to the bottom of the shaft, and the two move together. Be sure that the long cords coming from the upper jacks through the center of the loom pass BEHIND the shaft and corresponding upper lam before being connected to the lower lam.

After the cords have been attached to the lams according to the tie-up draft, the cords should pass directly to the treadles. At no time do the cords from the upper lam pass through an empty hole on the lower lam. This would only restrict the movement of the lams. Pull the

front shaft forward with the upper lam. All the cords on the upper lam should fall straight down and not loop over the lower lam. Next, pull the lower lam forward and be sure all the cords fall straight down. Continue through all the shafts and *then* tie the cords to the treadles. *Do not* space the cords out in every other hole. This only spreads the lams too far apart and they will be unable to "mesh" when the treadle is pressed and the shed will be cropped.

Start to tie up the treadles by putting the first cord toward the front of the loom into the treadle. The height of the treadle is very important. The free end of the treadle should be about 7" from the floor, or nearly level. By tying the first cord, the correct height of the treadle can be determined and the rest of the cords will follow at the same tension. To get the right tension on the second cord press slightly on the treadle so that the first cord is pulled taut. The second cord should then be pulled taut and tied at that tension. Proceed from the front to back cord until complete. When all cords have been tied and a slight pressure put on the treadle, the tension on all cords should be as equal as possible. If there is a variation in tension, feel for the tight cord and loosen it rather than tightening the loose cord. This prevents the treadle from rising.

**Note:** If you are tying 8 or 10 shafts, the back cords should be slightly tighter than the front 4. It will be easier to get the proper tension on the cords without raising the treadle too high by starting in the front and working toward the back.

Counter-marche weaving is almost effortless. It takes no more effort on the part of the weaver to raise one shaft than it does to raise 5 or 9. That's because the way the system balances. Think of the upper counter-marche jacks as the top of a scale. The pivot point is in the middle of the jack. If you placed all of the shafts and upper lams in one

side of the scale and all of the lower lams and treadles in the other side of the scale, they would balance. This is why all of the treadles must be tied up even if you don't need them. It is the total weight of all treadles that keeps the system perfectly balanced. If, for instance, you are weaving with 4 shafts and only have two tabby treadles tied,

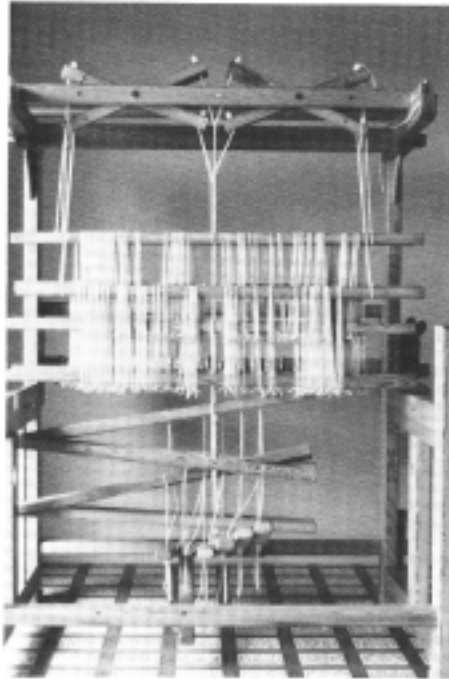

4. Counter-marche loom with open shed. Note the intermeshing of the lams, necessary for maximum shed opening to occur.

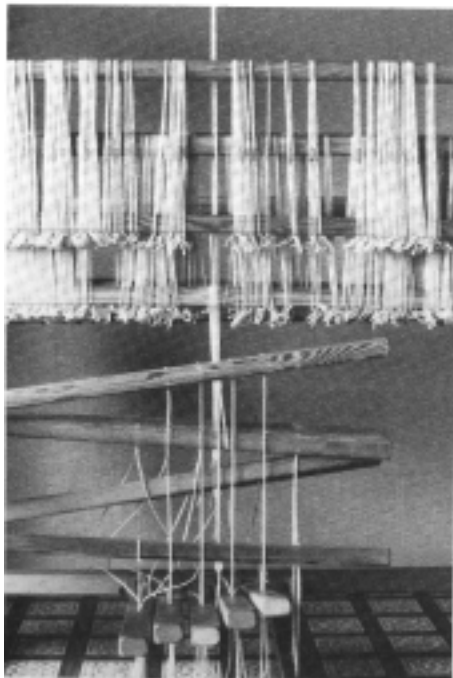

5. Detail of lams intermeshing when shed is open.

When you pull out the locking pins to weave, the shafts fall or sag downwards. Put the pins back in and tie up all 6 treadles. Now remove the pins, the shafts should not move downward, the system is correctly balanced.

If you weave on a 4 shaft loom, keep all 6 treadles tied up. If you weave on an 8 or 10 shaft loom, keep 10 or 12 treadles tied up. Normally you need 2 more treadles than you have shafts to balance the counter-marche system.

Tying up a counter-march loom is simple if you understand the system. It is the loom with the most efficient shedding mechanism. Unfortunately there has not been much information available about counter-marche. Education is the answer.

#### SUMMARY OF THE COUNTERMARCHE TIE-UP

1. Lock the jacks with lock pins.
2. Determine the position of the shafts so that the warp threads lay in the center of the heddle eye.
3. Measure the distance between the bottom of the shaft and the floor and determine the 4 sections of the loom set-up.
4. Check that the shafts are tied correctly to the lams. The open end of the lams should be 1" to 1½" higher than the hinged end. The long cords coming from the upper jacks through the center of the loom must pass behind the shaft and corresponding upper lam before being connected to the lower lam.
5. Attach the tie-up cords to the lams according to the tie-up draft (X to upper lams, O to lower lams).
6. Tie the cords to the treadles from front to back.
7. Check that the treadles are nearly level when tied.
8. Remove pins and start weaving.

# COMING EVENTS

Deadline for items in the Spring 1984 issue is February 1

## CALIFORNIA

**Fullerton.** Sep. 2-18, 1984. Tour thru Ireland for the Exploration of Irish Textiles. Barbara Baggeroer, director and educational guide. College credit available. For information contact: Fullerton Travel Center, 124 Laguna Rd., Fullerton, CA 92635.

**Ventura.** Jan. 30-Feb. 14, 1984. The Fabulous Potholder Show (fiber or fiber technique) held at Three Shuttles, 1909 E. Main Street, Ventura, CA 93003. For information write: Jan R. Eubank, P.O. Box 7211, Ventura, CA 93006

## COLORADO

**Denver.** Aug. 24-26, 1984. "The Art of Crafts—Festival '84" Denver's first major juried crafts exhibit and sale. Held at the Denver Art Museum, 100 West 14th Ave. Pkwy., Denver, CO. Open to artists working in ceramics, glass, jewelry, wood, leather, paper, metal, fiber, and mixed media. Entries will be juried and prize money awarded. Deadline for applications Mar. 1, 1984. For application forms write: "The Art of Crafts," P.O. Box 38233, Denver, CO 80238.

## CONNECTICUT

**Guilford.** Jul. 19-21, 1984. 27th Annual Guilford Handcrafts Exposition on the Guilford Green. Open to all craft media. Application fee \$10.00; deadline Jan. 27, 1984. For further information write: Guilford Handcrafts EXPO 1984, Box 221, Guilford, CT 06437

**Guilford.** May 6-27, 1984. "Dreams and Other Illusions" a multimedia show. Juried by slides only. Jury fee: \$10.00; deadline Mar. 16, 1984. For application write: Dreams, Guilford Handcrafts, Inc., Box 221, Guilford, CT 06437. Include SASE.

## IOWA

**Ames.** Dec. 4, 1983-Jan. 28, 1984. Clay Fiber Paper as Medium '84. For artists within 500 mile radius of Ames, IA. Judge Naomi Whiting Tower. For information send SASE to: Clay Fiber Paper as Medium '84, The Octagon Center for the Arts, Fifth and Douglas, Ames, IA 50010

## LOUISIANA

**Hammond.** Feb. 26-Mar. 18, 1984. 17th Annual Craftsman's Show sponsored by the Louisiana Crafts Council will be exhibited at Clark Hall Art Gallery, Southeastern Louisiana University, Hammond. Juried by Gerry Williams

**Baton Rouge.** Feb. 11, 12, 1984. The Louisiana Crafts Council 10th Annual Workshops, held on the campus of Louisiana State University, Baton Rouge, LA. Fiber. Basketry with Shereen LaPlantz. For further information write: Louisiana Crafts Council, 7214 St. Charles Ave. #922, New Orleans, LA 70118.

**Troy.** Mar. 8-11, 1984. Michigan Weavers' Guild Exhibit and Sale, held at Somerset Mall, Big Beaver at Coodige, Troy, MI. Demonstrations in spinning and weaving. For more information write: Nancy Pack, 618 N. Rosevere, Dearborn, MI 48128

**Farmington Hills.** Apr. 7, 1984. "Spinaround '84" held at Mercy Conference Center, Farmington Hills, MI. Lecture, workshops, demonstrations, exhibits. For information contact: Sue Walton-Bigelow, 808 Oakridge Ave., Royal Oak, MI 48067.

## MINNESOTA

**St. Paul.** June 3-6, 1984. "Byways in Fiber"—An Exploration of Ethnic Diversity. Guest speakers: Walter Nottingham, Noel Bennett, Anita Mayer. Workshops, seminars, exhibits, gallery shows and tours, fashion show, demonstrations. For more information contact: Weavers Guild of Minnesota, 2402 University Ave., St. Paul, MN 55114

## MONTANA

**Polson.** June 18-July 31, 1984. Montana Institute of Arts Open Juried Exhibition. Juried by slides. Due by Feb. 10, 1984. Juror: Frederick Wong. All media: two dimensional or low-profile wall pieces only. Fee: \$10.00 for one entry, \$5.00 each additional. Maximum of 4 entries. For prospectus send SASE to: S. Donnelly, R. R. 5366, Great Falls, MT 59401.

## NEW MEXICO

**Las Cruces.** Mar. 1-25, 1984. "Handwoven '84" sponsored in conjunction with the New Mexico Weavers Conference and juried by Cloude Barrett will hang at the New Mexico State

## (NEW MEXICO)

University Museum, Las Cruces, NM 88003. Residents from New Mexico, Arizona, Colorado, Utah, Texas and Oklahoma are eligible to enter. For prospectus write: Helen Garner, 1105 Calle del Encanto, Las Cruces, NM 88005

**Las Cruces.** Mar. 23-25, 1984. Second New Mexico Weavers Conference hosted by Mesilla Valley Weavers Guild. Juried by Cloude Barrett. Workshops, seminars, fashion show, commercial exhibits. For more information contact Nancy Soreng, 1105 Calle del Encanto, Las Cruces, NM 88005

**Los Alamos.** Feb. 10-Mar. 4, 1984. Intermountain Weaver's Guild Biennial Convention Juried Exhibit. Sponsored by Western States Arts Foundation, New Mexico Arts Division, Utah Arts Commission and Fuller Lodge Art Center. Held at Fuller Lodge Art Center, 2132 Central Ave., Los Alamos, NM. For more information write: Karen Noll Purucker, Director, Fuller Lodge Art Center, P.O. Box 790, Los Alamos, NM 87544

## NEW YORK

**Ithaca.** Mar. 3-4, 1984. 4th Annual "Spring Fever" Craft Sale and Exhibit. Held at Womens Community Bldg., 100 West Seneca St., Ithaca. Sponsored by Seven Valley Weavers Guild in cooperation with others. For more information contact: Mildred Scudder, Coordinator, 49 German Crossroad, Ithaca, NY 14850.

**New York City.** Jan. 29, 1984. A one-day workshop on "Felt-making" by Beth Beede will be presented at regular meeting of New York Guild of Handweavers. Held at Crafts Student League, YWCA of New York, 610 Lexington Ave., NY, NY. Feb. 25, 1984. Lecture on year in "Australia and Asia" by Douglas Fuchs at regular meeting of New York Guild of Handweavers. Held at Crafts Students League, YWCA of New York, 610 Lexington Ave., NY, NY. For further information contact: Jackie Davidson, 32 Bank St., NY, NY 10014.

**Pittsford.** Aug. 3-19, 1984. Yugoslavia Craft Tour. Visit cities and villages of Yugoslavia. Also included in tour: a commercial weaving and handweaving factory, Decorativa Factory, a blacksmith, coppersmith, village lacemakers, shoemaker, regional needlework. For more information contact: Craft World Tours, Rochester Travel Service, 50 State St., Pittsford, NY 14534.

**Rochester.** Apr. 26-May 11, 1984. "Fibers: Yesterday, Today, Tomorrow," sponsored by Weavers' Guild of Rochester, NY. Held at Ward Gallery of Sibley's Department Store, Main Street, Rochester, NY. Members' juried show, demonstrations, educational corner, fashion show, and sale. For more information write: Mrs. Peter S. Clark, 90 Camberley Pl., Penfield, NY 14526.

## OREGON

**Portland.** Feb. 28-Apr. 22, 1984. Art Museum and Portland Center for the Visual Arts. Magdalena Abakanowicz retrospective premiered in Chicago. This retrospective surveys her work of the last 20 years, from her monumental, three-dimensional woven sculptures of the mid-1960's to early 1970's—the *Abakans*—to her cycles of sculptures based on the human figure dating from the 1970's to the present and collectively called the *Alterations*. A recent group of large drawings will complement the sculptures. The installations at each location will be conceived of as total environmental works of art by the artist who will travel from Poland to execute them personally.

**Dallas.** Museum of Fine Arts, Texas—Jun. 21-Aug. 19, 1984. Frederick S. Wright Art Gallery.

**Los Angeles—Sep. 23-Nov. 11, 1984.** University of California. Following its North American tour, the exhibition will be presented at distinguished museums in Japan.

## PENNSYLVANIA

**Harrisburg.** Mar. 9-11, 1984. 2nd Annual PA National Arts and Crafts Show to be held at the PA. State Farm Show Building. Juried show for all arts and crafts from 3 slides. Entry fee is \$5 and deadline is Jan. 20, 1984. Exhibits. Displays. Demonstrations. For more information contact: Kay Kishbaugh, PA. National Arts & Crafts Show, P.O. Box 11469, Harrisburg, PA 17108-1469.

**Philadelphia.** Mar. 17-Apr. 14, 1984. "The Contemporary Weaver." The thirty-first annual juried exhibition of the work by members of the Philadelphia Guild of Handweavers will be on display at the Goldie Paley Design Center, Philadelphia College of Textiles and Science, 4200 Henry Ave., Philadelphia, PA 19144. For more information write: Cynthia Lawrence, Exhibit Publicity Chairman, 1221 Lois Rd., Maple Glen, PA 19002.

## TENNESSEE

**Gallatinburg.** Mar. 4-30, 1984. Arrowmont School of Arts and Crafts announces assistantships for spring series of mixed media workshop sessions. Applicant must take class one week and work one week. U.G. and G. credit is available. Deadline is Jan. 20. For more information write: Arrowmont School, P.O. Box 567, Gallatinburg, TN 37738.

**Gallatinburg.** Mar. 4-30, 1984. "Friends of Arrowmont" scholarships available for 1 week mixed media workshops. To apply, send resume, letter of application citing financial need and how you perceive the program to benefit you, and 3 letters of reference sent directly to the school. For more information write: Arrowmont School, P.O. Box 567, Gallatinburg, TN 37738.

**Gallatinburg.** Mar. 5-9, 1984. Arrowmont School of Arts and Crafts announces spring workshop schedule including fiber class: Woven wearables. Kathy Woolf. For more information contact: Arrowmont School of Arts and Crafts, Box 567, Gallatinburg, TN 37738.

**Smithville.** Nov. 11-Dec. 24, 1984. The Appalachian Center for Crafts is sponsoring a national juried competition for apparel fabric including knitted, woven, or surface design yardage from 3 to 25 yards. "Fabric Art: A Synthesis of Designer and Craftsman." Entry fee: \$5.00. Application, fee and work due: Sept. 21, 1984. Held at Appalachian Center for Crafts, Tennessee Tech. University, Cookeville, TN. For show prospectus, write: Joel Loguidice, Project Director, Appalachian Center for Crafts, Route 3, Box 347 A-1, Smithville, TN 37166.

## TEXAS

**Dallas.** June 20-24, 1984. Convergence '84. The Biennial Conference of Handweavers Guild of America will be held June 20-24, 1984 in Dallas, TX. Workshop sessions are planned 3 days preceding the conference and 5 days immediately following. For information contact: Handweavers Guild of America, 65 La Salle Rd., West Hartford, CT 06107.

**Houston.** Feb. 20-Mar. 4, 1984. WEAVERS III. Contemporary Handweavers of Houston juried exhibition of handwoven clothing and home furnishings. Held at Craft Industries, #78 Woodlake Square, Houston, TX 77063. For more information, contact Diane Ferguson at Craft Industries.

## VERMONT

**Middlebury.** May 12-June 16, 1984. Handwoven Clothing Exhibition. Held at Vermont State Craft Center at Frog Hollow, Middlebury, VT. Work by Vermont weavers. Guest curator Mary Lynn O'Shea, will also exhibit her work. For more information write: Vermont State Craft Center at Frog Hollow, Middlebury, VT 05783.

## WISCONSIN

**Mineral Point.** July 11-13, 1984. Second Annual Conference on the Creation of Complex Weave Structures. The conference will accept papers related to historic or ethnic woven structures, innovative manipulation of weave structures, application of computers or innovative technology to any aspect of textiles. Abstracts of papers due by May 10, 1984. Sponsored by Charles Babbage Research Centre, St. Pierre, Manitoba. Held at The Looms, Shake Rag Street, Mineral Point, WI 53565. For information write to: Ken Colwell, The Looms Shake Rag Street, Mineral Point, WI 53565 or Janet A. Hoskins, Dept. of Clothing and Textiles, University of Manitoba, Winnipeg, Manitoba, R3T 2N2.

## CANADA

**Prince George, British Columbia.** Oct. 1-27, 1984. The Prince George Weavers and Spinners Guild is organizing a juried fabric exhibition to be held in conjunction with their 10th Anniversary Celebration Conference. All weavers are eligible to enter. We especially hope ex-members will send work to share. The exhibition will be installed at the Prince George Art Gallery. For more information and entry forms send SASE to: "Webs", c/o P. G. Weavers and Spinners, 2880 15th Ave., Prince George, B.C., Canada V2M 1T1.

**Toronto, Ontario.** Jan., Feb., Mar. 1984. "Hand & Eye" Seven Hours on Seven Arts. Tentative telecast. TIES THAT BIND: FIBRES. Among the artists featured are Christo (Bulgarian-American) and Manette Rousseau-Vermette of Ste. Adele, Quebec. For more information write: Jan Oddie, Publicist, Canadian Broadcasting Corp., TV Arts, Music & Science, P.O. Box 500, Station "A", Toronto, Ontario, Canada M5W 1E6.



# THE WEAVER'S MARKET-CLASSIFIED

## EQUIPMENT

**FOR SALE:** AVL 60" production dobby loom, fly shuttle beater, sectional beam, tensioner, 1 year new, store display model, excellent condition. Asking \$3,850.00, compare at \$4,675.00. BOLL WEAVEL'S, 22 W. Chicago Ave., Naperville, IL 60540 312/357-3687.

**BEAUTIFULLY CRAFTED** hardwood spinning and weaving equipment Squirrel Cage Swifts, Drum Carder Needles Yarnblockers (kits available) and an attachment that quickly converts our Yarnblocker into a Horizontal Warping Reel. Illustrated brochure \$1 from: TRADITIONAL FIBER TOOLS, 885 Glendower, Ashland, OR 97520.

**KNITTING MACHINES** for your handspun and textured yarns. Combine knitting and weaving techniques for a stunning wardrobe! SASE for free brochure. LINDA SNOW—FIBERS, Fiber Headquarters of the Southeast, 3209 Doctors Lake Drive, Orange Park, FL 32073.

**THE BOND KNITTING FRAME** even does handspun! It's in stock at Webs. \$225.00. No charge for shipping. Check, MC or Visa. WEBS, P.O. Box 349, Amherst, MA 01004, 413/253-2580. (Mass. residents add 5% sales tax.)

**FLOOR & TABLE LOOMS** designed by Rollo Purrington, made by the NORRISES, 52W Willowbrook Road, Storrs, CT 06268. SASE for brochure.

## PUBLICATIONS

**ARS TEXTRINA**— A new scholarly professional journal devoted to the history, theory and practice of complex weaves. Subscription and paper submission information from: ARS TEXTRINA, c/o Dept. of Clothing & Textiles, University of Manitoba, Winnipeg, Manitoba R3T 2N2.

**HARRY LINDER'S LATEST BOOK**, "Techniques of Code Drafting, The Lively Art of Personal Weaving Drafts." \$18.95 + postage from BIZARRE BUTTERFLY PUBLISHING, 1347 E. San Miguel, Phoenix, AZ 85014. Dealers welcome.

### BOOKS FOR THE HOME CRAFTSMAN

|                                                                                                  |                                                                                       |        |
|--------------------------------------------------------------------------------------------------|---------------------------------------------------------------------------------------|--------|
| EARTH BASKETRY: Known as Complete Basket Manual                                                  | Hard cover.                                                                           | \$9.95 |
| THE JOY OF HANDWEAVING                                                                           | Basic instruction for beginners, with guidance for teachers. 40 step by step lessons. |        |
|                                                                                                  | Hard cover.                                                                           | \$9.95 |
| RUGWEAVING FOR EVERYONE: Pile, Tapestry, 4 to 8 harness. Tufted and Flat techniques              | Paperback.                                                                            | \$4.50 |
| BOBBIN LACE STEP BY STEP: Directions for making your own pillow, beginners & practical patterns. |                                                                                       | \$7.50 |

OSMA GALLINGER TOD  
c/o J. Del Deo  
Box 573  
Provincetown, MA 02657

**PCWEAVER.** The weaving program for the IBM Personal Computer. Easy-to-use draft "worksheet" display, 4-8 harnesses, 4-10 treadles, draft/drawdown printouts, color and weave effects (black/white), draft storage and retrieval. Requires 64K Memory, disk BASIC, 80-column display. Epson MX-80 printer optional. Program and Documentation—\$40.00. Documentation—\$2.00. STAR\*SYSTEMS, 28 Topstone Drive, Bethel, CT 06801.

**COMMODORE 64 PROGRAM.** "Design-A-Draft" Select thread-by-thread draft, tie-up and treadling and produce drawdowns in minutes. Up to 8 harnesses, 10 treadles, 40 warp threads, 24 weft shots and 16 colors. Drafts stored on disc. Very "user friendly," menu driven. Set up for 1525 printer or Gemini 10x with cardco. Disc plus manual \$35.00 - U.S. funds, \$40.00 Canadian. For more information send S.A.S.E. to: CONROY SOFTWARE, 3423 Southgate Rd., Ottawa, Ontario K1V 7Y5.

**COMPUCRAFTS** introduces "THE WEAVER" © 1983. An extremely powerful computer weaving drawdown program for the APPLE II PLUS or IIe. Up to 8 harnesses, 10 treadles, 280 warps, 160 wefts. Features color, magnification, rising and sinking sheds, printouts of pattern and draft in traditional or counted formats. Interactive and automatic treadling. Create a data-base of designs and drafts for later review and/or modification. Send \$49.95 for disk plus manual or for complete information contact COMPUCRAFTS, RFD 2 Box 216, Lincoln, MA 01773.

**DRAWDOWN** for 48k Apple II Plus. Up to 8 harnesses, 10 treadles. Two thread widths with up to 254 warps. Editing for changing Threading, Tie-up and Treadling which are displayed together with Drawdown. Save on disk and Recall for further work. Printouts with Grappler+ or PKASO (specify). Complete instructions. Send \$35 to VOLUME 7 SOFTWARE, 408 N. Bradley, Mt. Pleasant, MI 48858.

**PATTERN MASTER III.**—Drawdowns up to 255 x 150, analyzed to 41 shafts, 23 treadles, or dobby. Displays cross-sectional drawdowns for up to four layers, with double cloth at 1/1, 1/2, & 1/3 warp ratios. Also flat drawdowns single or double. The new systems value menu details design data, gives quick change of rows and columns. Displays draft converted to block weave of your choice. Data-base creates over one million twills. Much more. Uses Apple II+ or e, two drives, prints thru Grappler card. In USA, THE LOOMS, Shake Rag St., Mineral Point, WI 53565. 608/987-2277.

**PATTERN DEVICES FOR HANDWEAVERS**—125 pages, illustrated. Instructions for Beiderwand, damask, double weave, twills, supplementary warp and weft patterning using standard looms, modifications, and special devices including pick-up sticks, long-eyed heddles, pattern harnesses, and drawlooms. \$18.00 plus \$2.00 shipping. DORAMAY KEASBEY, 5031 Alta Vista Road, Bethesda, MD 20814.

**HANDSPINNING** by Eliza Leadbeater—revised paperback edition, \$10.00 postpaid. Also available YOUR HANDSPINNING by

Davenport, \$6.55 postpaid and LEGACY OF THE GREAT WHEEL by Turner, \$10.00 postpaid. Wholesale inquiries welcomed. SELECT BOOKS, Route 1, Box 129C, Mountain View, MO 65548.

**BHUTAN SPECIAL ISSUE:**—Weaving, costume, adventure, books! Send \$5.00. THE TEXTILE BOOKLIST, Box C-20W, Lopez Island, WA 98261.

**MULTIPLE HARNESS PATTERNS** from the early 1700's: The Snavelly Patterns. 110 drafts, drawdowns, photos. \$8.50 ppd. ISABEL I. ABEL, R.D. 4, Box 44, Altoona, PA 16601.

"FIBRE FORUM" is the magazine of the textile arts in Australia. Subscriptions in 1984 are US\$16 and CAN\$20. Appears three times a year, with colour. Articles on all aspects of textile expression. Subscribe through R. L. Shep, Box C-20, Lopez, WA 98261. Fee should accompany subscription. Back issues available.

## STUDY OPPORTUNITIES

Tucson, Arizona  
**HEADIN' SOUTH?**  
Spinning·Weaving·Dyeing  
Winter Workshop Schedule... SASE!

 Spin 'n Weave  
2725 N. Campbell Ave. Tucson, Az. 85719  
602/323-9287

**NORWEGIAN WEAVING TOUR**—2½ weeks weaving in Craftschool plus sightseeing. June 1984. NORMA SMAYDA, P.O. Box 517, Saunderson, RI 02874. 401/294-3676.

**WEAVERS AND HANDICRAFT TOUR OF SCANDINAVIA** (Denmark, Sweden and Finland) led by Joanne Tallarovic—August 4-18, 1984. Visit the Glimakra Loom Factory/Weaving School • Marimekko • Marta Maas Fjeterstrom • Klippans Wool Factory. Information/brochure: RIVER CITY TRAVEL, 19655 Detroit Rd., Rocky River, OH 44116. Tel. No. 216/333-1600.

**WANTED:** Seminar and workshop leaders for Assoc. of N.W. Weaver's Conference to be held in Tacoma, WA. June 9-15, 1985. Please submit resumes to JINNY HOPP, Rt. 1 Box 184P, Eatonville, WA 98328 by March 15, 1984.

## Pendleton

### FABRIC CRAFT SCHOOL

Enjoy a creative variation in Sedona's spectacular red rock country. Workshops in all phases of handweaving and related subjects.

Instructors: Inga Krook, Kalmar, Sweden, Mary Pendleton, Sedona, Arizona.

College credit optional. Write for brochure. P.O. Box 233 • Sedona • Arizona 86336  
602-282-3671

## ADVERTISERS INDEX

|                                      |        |
|--------------------------------------|--------|
| Ahrens & Violette Looms, Inc.        | 92     |
| Ayottes Designery                    | 31     |
| Bradshaw Manufacturing Company       | 60     |
| Classified Ads                       | 89     |
| Cyrefco                              | 90     |
| Frederick J. Fawcett, Inc.           | 7      |
| The Fiber Collection                 | 6      |
| Glimakra Looms 'n Yarns, Inc.        | 2, 84  |
| The Golden Heddle                    | 21     |
| Grandor Industries, Ltd.             | 71     |
| Harrisville Designs                  | 23     |
| Henry's Attic                        | 7      |
| Bette Hochberg                       | 63     |
| Ruth N. Holroyd                      | 40     |
| Ident-ify Label Corporation          | 83     |
| Indigo Press                         | 63     |
| Ironstone Warehouse                  | 83     |
| JaggerSpun                           | 17     |
| J & D Highland Imports               | 6      |
| Leclerc Looms                        | 9      |
| The Linden Tree                      | 63     |
| Macomber Looms                       | 48, 91 |
| The Mannings                         | 11, 24 |
| Once Upon a Sheep                    | 21     |
| Or. Rug Co.                          | 40     |
| Pacific Search Press                 | 24     |
| Pendleton Shop                       | 89     |
| Katherine Ramus                      | 48     |
| Rio Grand Wool Mill, Inc.            | 34     |
| Santa Fe Center for Fiber Arts, Inc. | 52     |
| Santa Fe Weaver's School             | 63     |
| School Products Company              | 7      |
| Serendipity Shop                     | 24     |
| E. F. Shaw Company, Inc.             | 71     |
| Sievers Looms                        | 75     |
| Silk City Fibers                     | 24     |
| Spin 'n Weave                        | 89     |
| Swedes In Town                       | 21     |
| Textilforum                          | 60     |
| Osma Gallinger Tod                   | 89     |
| Traditional Fiber Tools              | 71     |
| Weaver's Journal Publications        | 25     |
| The Weaver's Loft                    | 53     |
| Weaver's Way                         | 31     |
| Wilde Yarns                          | 63     |
| Wonder Craft                         | 75     |
| The Wool Gallery                     | 53     |

## YARNS, FIBERS, FLEECE

**ALPACA YARNS & PLANT DYED WOOLS** from Peru. Free samples. DRAGONFLY STUDIO, P.O. Box 482W, Lafayette, CO 80026 303/665-9504.

**BERGA YARNS.** Glimakra, Gesta Looms, supplies and books. Send SASE for information or \$6.00 for set of sample cards. MARY A. CHASE, Swedish Yarns, P.O. Bldg., South Brooksville, ME 04617.

**BORDER LEICESTER WOOL.** Skirted \$3.00/lb; skirted and scoured \$4.50/lb. Include mailing/shipping fees. P.O. Box 486, Helena, MT 59624.

**FINN WOOL YARN** (extra soft), spinning wheels, knitting machines, fibres, books, portable sheep fencing. Free catalog. WOOLERY, RD 1, Genoa, NY 13071. 315/497-1542.

**FROM 'THE GREAT WHITE NORTH'** comes mohair at its best. FINE YARNS of Canada brings you our all-natural yarn of 70% Canadian mohair (the world's finest) and 30% wool. With no synthetics, this durable yarn is easily woven into luxurious garments which last for years. For colour samples and incentive price list, send \$2.00 to FINE YARNS, Box 1414, Sudbury, Ontario P3E 5K4. Nothing dyes, wears or feels like mohair!

**HAND-SPUN 100% WOOL YARN.** \$9.00/lb. 475 yards. Hand-made blankets, scarves, socks TOUCHING CULTURES. Retailw/j. 1437 W. Howard, Chicago, IL 60626

**LONG & LUSTROUS FLEECE**—Romney & Lincoln—white, colored & vegetal dyed, mohair & angora. Samples \$1/SASE. Hand-spun, samples \$2/SASE. Custom carding, dyestuffs, looms, wheels, catalog N/C. Breeding stock WILLOW POND WOOLS, WJ Rt 1, Box 166-F, Ware Shoals, SC 29692, 803-861-2031.

**MILL END and FIRST RUN YARNS.** Natural and dyed cotton, wool, synthetics. Samples \$1.00. Catalog \$1.00. EARTH GUILD, Department WJ, One Tingle Alley, Asheville, NC 28801.

**MILL END YARNS,** threads, etc. Natural, synthetic and blends, varied sizes and types. New items added constantly. Low mill end prices on yarns. Sample catalog and mailing list for 1 year \$2. YARN BARN, P.O. Box 1191, Canton, GA 30114.

**MILL ENDS,** wools, cottons, synthetics and blends, for weaving or knitting machines. Mill End Mailings, at least four per year—\$3.00. LINDA SNOW—FIBERS, Fiber Headquarters of the Southeast, 3209 Doctors Lake Drive, Orange Park, FL 32073.

**MOHAIR—WOOL LOOP—NEW STOCK** 17 colors. Also Alpaca and specialty wools. Samples: \$1 plus #10 SASE (37c). CUSTOM HANDWEAVING, Box 477, Dept. WJ, Redondo Beach, CA 90277-0477.

**100% WOOL YARN: Wool Marked R production overruns at millend prices.** More than 1,200 colors in weaving weights. Reorder from our computerized color and dye lot control system. Price range \$2.50/lb. to \$4.00/lb. Add 30 cents shipping east of Mississippi River and 60 cents west, or \$4.00 for color card of 88 running stock colors. SPINNING WHEEL YARNS, P.O. BOX 5076, Dept. W1, Asheville, NC 28813.

**SHEEPSKIN PIECES**—Cleaned, random sizes. Make rugs, vests, seatcovers. Instructions with order. 1 lb. \$4.00; 5 lbs. \$16; 10 lbs. \$28; plus shipping. CUSTOM HANDWEAVING, Box 477, Dept. WJ, Redondo Beach, CA 90277-0477.

**SILK. SILK. SILK.** New silk stock. 70 exciting colors. Quantities limited. Complete samples \$4. CUSTOM HANDWEAVING, Box 477, Dept. WJ, Redondo Beach, CA 90277-0477.

**SILKS, WOOLS, LINENS, COTTONS, SYNTHETICS AND BLENDS**—Boucles in silk, wool or cotton, brushed mohairs and wools; nubby, highly textured yarns of all fibers in all weights for your weaving pleasure. Exotic tops for spinning, including our new 50% silk/50% wool tops. Complete line of spinning and weaving equipment, knitting machines, books and supplies. Samples: Yarns \$2.50; Spinning Fibers \$1.50. Catalog only 75c. LINDA SNOW—FIBERS, Fiber Headquarters of the Southeast, 3209 Doctors Lake Drive, Orange Park, FL 32073.

## MISCELLANEOUS

**HANDWOVEN BOUTIQUE ORIGINALS, FIBRES, PATTERNS, WEAVING/SPINNING EQUIPMENT**— Mail order catalog \$1.00. PATWELL, Box 17168, Milwaukee, WI 53217.

Rate is 50¢ per word; \$10.00 minimum.  
Deadline for Spring 1984 issue is February 1.

### Cyrefco — The Traditional Loom with a Difference

Features for today's weaver include: warp advance lever (warp advance from sitting position at the bench), constant tension brake, roller back beam, angled shuttle race, and counter balance with rollers for even/accurate shed.

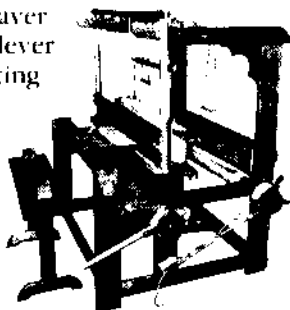

The beautiful hand-crafted 4/8 harness Cyrefco loom can be purchased finished, unfinished or in kit form. For more information send \$1.50 to Cyrefco, P.O. Box 1640, Palo Alto, CA 94302.





Simple familiar commands make it easy to use



Thread the loom.  
VIEW LEVEL 1



Repeat the Draft.  
VIEW LEVEL 2



Tie up the pedals.  
VIEW LEVEL 0



Weave the pattern as you prefer...



Or treadle-as-drawn-in.



Each thread [warp and/or weft] can have its own COLOR...  
VIEW LEVEL 5



SIZE, [warp]...  
VIEW LEVEL 2



and SPACING [weft].  
VIEW LEVEL 3



Insert warp or weft threads.



Fill in warp or weft threads.



Erase warp or weft threads.



You can zoom in...  
VIEW LEVEL 1  
Note that your draft can be positioned in any one of the four corners or all four.



Out...  
VIEW LEVEL 2



farther out...  
VIEW LEVEL 3



and farther out.  
VIEW LEVEL 4



You can examine the front of your fabric rising shed,



Or the back of your fabric falling shed.



The built in color wheel lets you choose from 256 colors.  
16 BASIC COLORS



16 SHADES of 1 color



You can combine the threading from one



pattern with the tie-up from a second



and the treadling from a third.

# WEAVE MASTER®

## THE TEXTILE DESIGN TOOL

## FROM MACOMBER LOOMS

**BUILDERS OF QUALITY TEXTILE PRODUCTS SINCE 1936. "ASK THE WEAVER WHO OWNS ONE."**

For further information call 207-363-2808 or write MACOMBER LOOMS, P.O. Box 186 Beech Ridge Road, York, Maine 03909 U.S.A.

Software by Broos Information Systems

*"I love my AVL, it made Production Handweaving a reality for me"*

Brook Trout, Weaver, Santa Rosa, California



Photo by Christian Pedersen

**"F**rom the time, fifteen years ago, that I first sat down at a loom, in the Panama Canal Zone of all places, I knew that weaving held a special fascination for me.

After a few years of experimentation, I started to explore different ways to make my living as a weaver. I wove rugs, pillows, and yardage, but it took so long that they simply weren't profitable.

I gave up on the idea until one day in late 1980 when I saw my first AVL loom. I instantly knew that I'd found the perfect production loom.

Today, in just three years, my business has become highly successful. I now use three AVL

looms and my line of women's fashions "brook weaves," is carried in shops from Honolulu to Martha's Vineyard.

I can honestly say that I couldn't have done it without AVL."



**AVL LOOMS**

601 Orange Street Dept 34  
Chico, California 95926  
(916) 893-4915

Send \$1 for complete catalog.

**AVL, Now the possibilities are endless.**