

MASTER  
WEAVER

BI-MONTHLY BULLETIN FOR HANDWEAVERS



MARCH · 1953

FULFORD · QUEBEC · CANADA

WHY NOT LEARN ALL ABOUT WEAVING  
AND HAVE YOUR SUMMER VACATIONS  
AT THE SAME TIME?

\*\*\*\*\*

You can spend from 1 to 8 weeks  
of Summer in our weaving studio.  
Only individual teaching.

\*\*\*\*\*

Write for information to:  
Z-HANDICRAFTS - Fulford, Quebec  
C A N A D A

---

# MASTER WEAVER

---

Z - HANDICRAFTS • FULFORD • QUEBEC • CANADA •

---

March, 1953

No.8

## PROBLEMS IN TEACHING

### The yarn and the sett of warp.

What we should have in mind when teaching weavers, is to give them enough technical knowledge to become creative. As long as one is not quite familiar with the tools one uses, there are too many limitations of a purely technical nature, and too much frustration in overcoming these difficulties. Creativeness under such circumstances is constantly thwarted. Consequently teaching should put more stress on understanding than on performing. Prescriptions, ready formulas, complete drafts and directions should be avoided as much as possible. Instead the student should be made to work out his problems by himself.

We shall apply this principle here to the question of selecting yarn for warp, and finding the proper sett. Very often this part of weaving is treated in the same way as cooking recipes: take 2/16 cotton, set it at 35 ends per inch and you will have a towel. But why 2/16, and why 35 - and not 20 or 50?

First of all - what is really the count of yarn? As we all know it indicates the weight: so many yards per pound. And somehow we think that it indicates the thickness as well. But how? What we often do not realise is the fact that in most cases the yarn has no definite diameter. In case of wire there is a quite simple relationship between the weight and the diameter, because the cross-section of a wire is a circle. But the cross-section of yarn shows a number of fibers (virtually points) widely spaced and separated by air.

If we take a micrometer and try to measure the thickness of yarn, we can always get at least two readings: first when the yarn starts touching metal on both sides, and the second when the mike is tightened as far as it will go. These two readings may be very far apart in case of a soft yarn, and quite close with a hard twist. For instance 2/6 cotton may give the figures: .035" and .007". But the same cotton twisted harder will give .025" and .012".

Since the "diameter" is not only indefinite, but even variable there cannot be any hard and fast rule directing us in the choice of the sett of warp. For instance if we want to find out how many ends per inch will cover completely the weft, and take as the basis our mike readings - we can have anything from 30 to 150 ends per inch for a 2/6 cotton. The lower limit of 30 means something - this is the lowest number which will cover the weft, but 150 is obviously impossible. No shed would open with so closely set warp. But then we may find out that with a different

make of the same 2/6 cotton the figures will be different, because the apparent thickness of the yarn depends on the twist, and not only on the weight.

The above example shows quite clearly why formulas for the sett of warp are without much value. At the best they can give you a general idea, but will not solve any practical problem.

There is no necessity to have a micrometer to be able to establish the lower limit of the sett for warp-face fabrics. We can as well take a ruler, and wind the yarn on it so that one thread just touches the next, and then count the number of windings which cover one inch.

The upper limit i.e. the highest sett which will still give an opened shed, or rather all sheds is only matter of experience. It depends to a great extent on the construction of the loom, and the weaver himself. The general principle is that the softer the yarn the higher this limit when compared with the lower one. If the lower is 30, then the higher may be 60 for soft, and 40 for hard twist.

So far we have been speaking about the fabrics where the warp covers the weft. The problem is much more difficult when it does not. For instance when we have a 50:50 fabric, we can weave it very open or very close, according to the effect desired. Then what in this case is the lowest and the highest limit?

The lower limit of sett will be such one which still does not produce the slippage after the fabric is finished. When the warp or the weft threads are subjected to friction going in one direction they should not move in the fabric and produce holes. The slippage depends not only from the grist of yarn used, but on other factors as well: twist, smoothness of yarn, finishing etc. For instance when the fabric is supposed to be sized (as cheesecloth) it may be woven much more open, than when it is not. Wool which is going to be fulled or felted can be more open too. Domestic wool (about 2000 yards per lb) usually set at 18 ends per inch, may be set at 9 and still produce a firm fabric if it is fulled afterwards. But slippery yarns such as rayon must be woven much more closely than cotton of the same count.

The upper limit is such a sett which will still give a 50:50 fabric with the heaviest possible beating. Consequently it depends not only from the yarn, but from the weight of the batten and the width of warp. So again we have no rules, and we have to experiment to find the answer.

Sometimes the upper limit may not be the one we were speaking about. When weaving tabby, a fabric woven at the closest sett of warp may be so tough as to be practically useless. For instance a linen towel woven with single 14 should not have more than 30 ends per inch, although it is possible to make it even 45, because beyond this limit it will be next to impossible to iron it smooth. But again it depends what kind of linen we use.

If the problem is so difficult with 50:50 fabrics - it will be more so with other ratios between warp and weft. Let us go to the other extreme and cover the warp with weft. With a given yarn for both, we may speak about the upper limit of the sett. This is the highest number of ends per inch, which still gives a warp-face fabric. This however involves such factors as the weight of the batten, and the width of the fabric again. The lower limit is still less well defined.

One may protest here that after all in the industry they do not go when designing a new fabric through hundreds of experiments with

all possible setts of warp, that they must have rules and formulas. This is perfectly true, but the kind of formulas they use are far from being simple and they just cannot be applied to the handweaving. Not only because they require the knowledge of higher mathematics, but because to use them one has to have much more information about the physical properties of yarn, than we can ever learn when buying our supplies, and it would require a well equipped scientific laboratory to find them out by ourselves.

Still there are certain simple rules which may be useful. For instance if we find a very satisfactory proportion between yarn and sett in a particular fabric, we may use this proportion to make similar fabrics (the same weave, the same material) in different weights. The table on page 4 is based on such a simple rule: the weight of the yarn is proportional to the square of its thickness. For instance 2/4 yarn is twice as heavy as 2/8 - but this does not mean that the thickness is double also. If we increase the weight twice, the thickness will increase by only 41%. To get twice the thickness we must find a yarn four times as heavy. Thus the sett of warp must be inversely proportional to the thickness and not to the weight of yarn. The formula is:

$$S = k \sqrt{C};$$

where S is sett in ends per inch, C - the count of yarn, and "k" - a coefficient which remains the same if the weave and the material remain unchanged. It is about 12 for cotton woven in tabby, 9 for wool, 7 for linen.

The table on page 4 is nothing but the same formula expressed graphically. The horizontal axis shows the count of yarn, and the vertical one - the sett. The table gives approximate figures for the lowest sett with different yarns woven into 50:50 fabrics. In practice closer setts than these given in the table will be used very often, but it is impossible to judge how much closer they should be without experimenting. There are two lines for each yarn: one roughly corresponding to tabby, the other to twill. Still lower setts may be used for processed fabrics.

At this stage the student is advised to make samples with different setts on small frame looms. These samples are then finished and compared until the best possible combination of yarn and sett is found. They are tried for slippage, creasing, resistance to ironing etc. All such samples with appropriate notes should be preserved for further use. The notes should contain not only the usual information about weave and yarn, but very detailed description of finishing, and all possible information about the yarn: composition, twist, behaviour in weaving, name of the manufacturer etc.

The main stress in teaching should be laid here on the complexity of the problems connected with selection of the proper sett, and on the unreliability of the formulas, thus developing student's initiative and resourcefulness in meeting the difficulties.

\*\*\*\*\*

Sett:

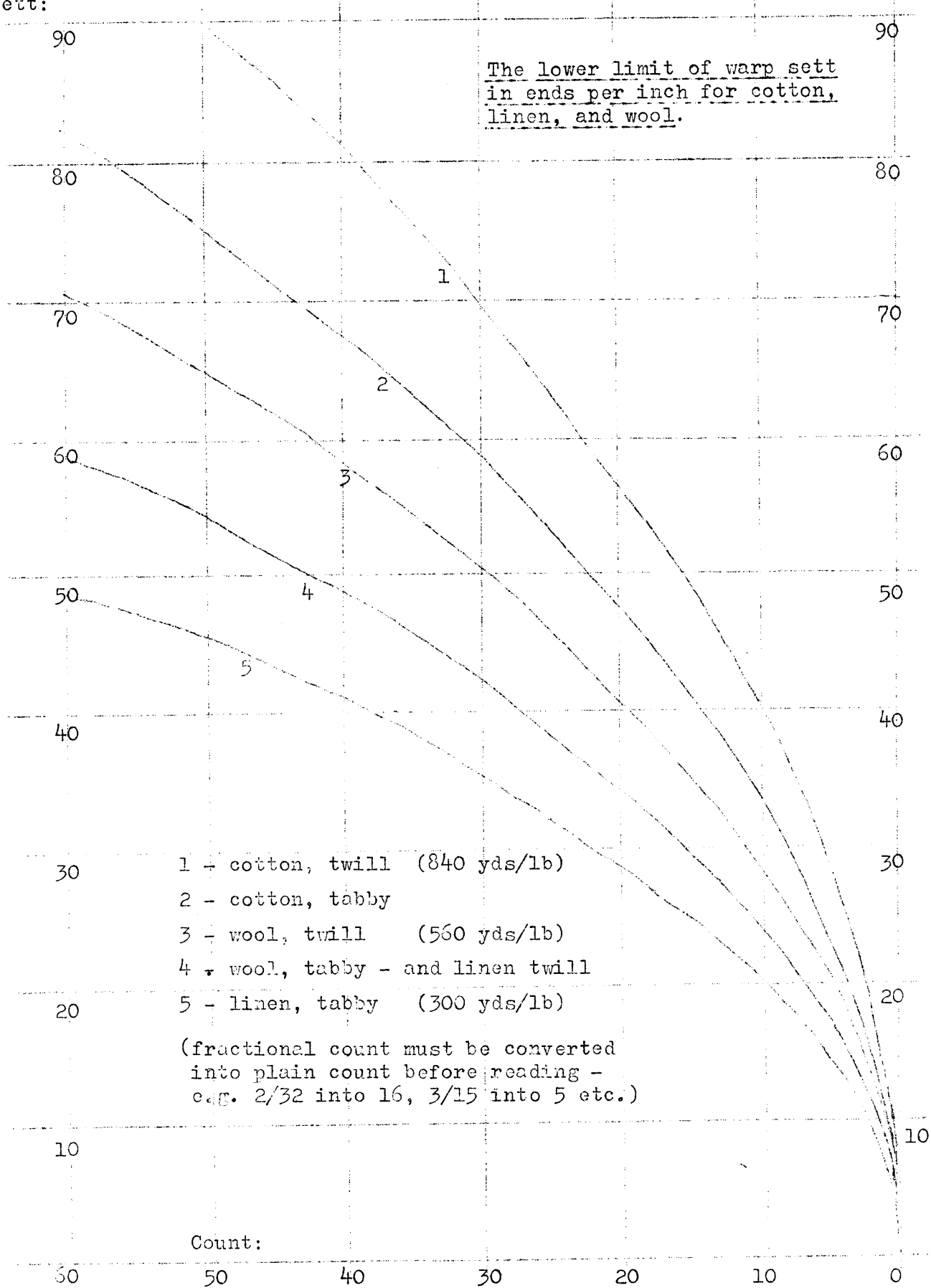

- 1 - cotton, twill (840 yds/lb)
- 2 - cotton, tabby
- 3 - wool, twill (560 yds/lb)
- 4 - wool, tabby - and linen twill
- 5 - linen, tabby (300 yds/lb)

(fractional count must be converted into plain count before reading - e.g. 2/32 into 16, 3/15 into 5 etc.)

Count:

# DOUBLE WEAVES

## DOUBLE FACE FABRICS

Not all double face fabrics belong to the Double Weaves family. We may safely say that most of them do not. But since they are difficult to classify, and since double weaving is the surest method of producing such fabrics, we shall speak here about all of them, with a particular attention given to the double fabrics proper as well as to the borderline cases where for instance two wefts are used on one warp, or two warps with one weft - the latter weaves being obviously derivate of double weaving.

Nearly every weaving technique can produce a fabric which will have two different sides, or two "faces". Exceptions are: tabby, plain basket, and balanced twills (2:2, 3:3 and so on), as well as certain pattern weaves based on the above ones - e.g. Swivel. Even overshot, crackle, or Summer-and-Winter have different patterns on both sides.

Nevertheless we apply the name "double face" only to the fabrics which have either different colours, different textures, or two completely different patterns - not just one being the reverse of the other.

The simplest weave which may produce such a fabric is 1:2 twill. If the warp is of one colour and the weft of another, then on each side a different colour will prevail. For instance if the black and white were used, we shall have one side light grey (mostly white) and the other - dark grey (mostly black). The higher the twill (1:3, 1:4, etc) the more pronounced the difference between the two faces. In satins particularly of a very high order (1:15) we get practically pure colours on both sides. Although we might expect even here 6% of the black to show on the white, in practice the floats hid the "ties".

Still this kind of double face fabrics have nothing to do with double weaving. In double weaving proper we should have two layers of fabric, each of a different colour (both warp and weft), and both stitched together. We shall discuss this particular weave in the next issue of MW. It is the best method of producing double-face fabrics, but it requires rather a large number of heddle-frames.

However if all we want are two colours on the two sides, and not necessarily two layers of fabric, we have simpler means of getting this effect. For instance we can have both sides "weft-face", i.e. the warp may be on both sides covered with the weft. If the warp is covered there is no more reason to use two warps for a double fabric - both sides may be woven on the same warp of a neutral colour, but we shall use two wefts of two colours, one for each side. This is an example of what we called before "a borderline case" of double weaving.

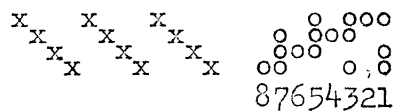

Fig.1

In the draft on fig.1 the warp is set rather far apart. In the treadling one colour is used on treadles: 1,3,5,7, and another on 2,4,6,8. The treadling for biased twill will be 1,2,3,4,5,6,7,8. and for a broken one: 1,2,3,4,7,8,5,6.

On the same threading and tie-up several other variations can be woven. For instance: Biased twill on one side and broken twill on the other: 1,2,3,4,5,8,7,6 or 1,2,3,4,7,6,5,8. Then one side may be woven in twill and the other in Summer-and-Winter (texture): 1,2,3,6,5,2,7,6. Or one side in twill and the other in crackle: 1,2,3,2,5,2,7,2 - but then the warp will be partly visible on one side. When we speak here about Summer-and-Winter or Crackle we mean only the similarity of texture. There is no pattern of course.

So far we have assumed that each side of the fabric will have one, more or less solid colour. More or less, because some of the colour of one side will show on the other. To minimize this effect the warp must be spaced so, that it will be just covered with weft, but it should not be too open. The weft should be rather soft and heavier than warp. More than one colour can be introduced on one or both faces, but in stripes only. This is because the weft is visible in its entire length, and if it is covered by warp it appears on the other side thus spoiling the whole effect. A "spotty" appearance may be obtained by using a different colour for each treadle. Then of course a different set of colours will be used on each side.

With a higher number of frames the results will be similar, but the warp may be set closer - even so the difference between the two sides will be more complete.

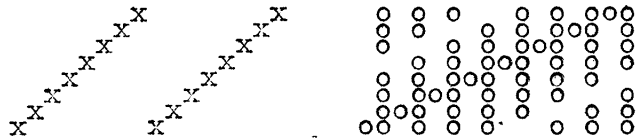

Fig. 2

In fig. 2 we have a draft for a 1:7 double face twill. One colour of weft for all odd numbered treadles, and another for the remaining ones. Treadling it straight from 1 to 16, or from 16

to 1, we shall have biased twills on both sides. Or by breaking up the order we may get two satins, or one biased twill and one satin.

If we change the tie-up (fig. 3) one side may be woven as 1:3 twill, and the other as 1:7 one. Either of them may be broken or biased.

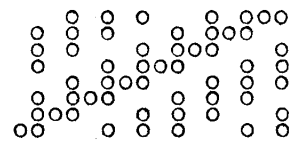

Fig. 3

Theoretically, instead of plain threading as in fig. 1 and 2, we can have diamond twill threadings as for instance in fig. 4. But the pattern will hardly show, except in relief. The reason for this is that each side shows mostly one colour and there is no contrast between the pattern weft, and the warp.

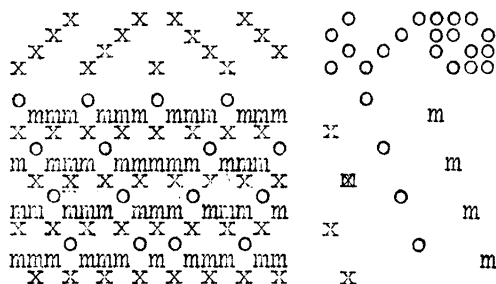

Fig. 4

If we want to have the pattern more visible, we can use binder. The same binder will serve for both sides. One shot of binder should always follow two shots of pattern: one on each side. Then of course the warp will show much more than without binder, and it is important to have it in a neutral colour - so to speak, half-way between the two colour used for the two faces.

When making drafts for such patterns we must take into consideration that at the turning point in threading we shall have rather long



floats, when compared with a biased twill, or with a balanced one of the same order. For instance in the above example (fig.4) we would have a float of 3 in a 2:2 twill, but in a double face twill there will be floats of 5 on both sides. This is the reason why for instance overshoot cannot be used at all in this technique. The floats would be much too long for practical use.

A problem in case of nearly every double face twill is the tie-up. It always requires more treadles than the loom is equipped with. For instance a 4 frame double face twill is woven on either 8 or 10 treadles, and 8 frame one - on 16 treadles and so on.

In such a case we have to use either direct, or partly direct tie-up. For instance instead of the tie-up on fig.1 we have the one

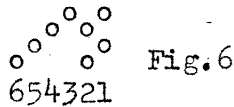
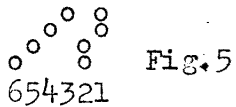

on fig.5. The treadles no.1,3, 5, and 7 on fig.1 are here replaced with a combination of two treadles used simultaneously, so that the treadling for biased twill will be:

2+3, 3, 1+6, 4, 1+5, 5, 2+4, 6. If binder is used, or any amount of tabby woven on the same tie-up, fig.6 gives a still better solution. Here the treadling for plain twill is: 1+6, 3, 2+3, 4, 1+4, 5, 2+5, 6. In a similar way most problems of treadling can be solved, although with a higher number of heddle-frames three treadles must be often used at the same time.

\*\*\*\*\*

## WEAVING TERMINOLOGY

### Lash, Leash, Lease.

There is a little confusion as to the proper use of these three terms, particularly in such expression as "Leash-Sticks". The last two have the same etymology, and were at a time used in the same meaning.

Lash comes from old English "lashe" (whip) and designates two picks of weft; probably the movement of the shuttle there and back suggested an analogy with the action of a whip.

Leash (possibly from Latin "laxus") is the same as Heddle in U.S. Therefore "leash-stick" in England means the same as Heddle-stick here, and never the same as Lease-Rods.

Lease is a corruption from Leash. Originally then both meant the same, but they do not any more. Now "lease" means the same as cross in the warp. Etymologically then it would not be a great mistake to speak about "leash-rods", or leash-sticks, but it certainly would be very confusing.

\*\*\*\*\*

## HORIZONTAL WARPING MILL

As far as the warping equipment is concerned, the weaver has a choice of: warping board, warping reel, or sectional warp beam. The two latter are suitable for long warps, but both have their drawbacks.

The best of all would be a warping mill, i.e. a vertical or horizontal reel with an automatic movement for winding the yarn. This further can be combined with a warping drum, i.e. an arrangement which permits direct beaming from the mill. Unfortunately no such equipment can be found on the market and the only way to get it, is to make it.

We shall divide the building of a warping mill into 2 stages:  
1) We shall make a horizontal reel, which can be used as a beaming drum  
2) Later, we shall add an attachment for guiding the yarn when warping.

The superiority of a horizontal reel over a vertical one is that with the former the warp does not need to be chained before it is beamed. When the warping comes to an end we have to take the warp off a vertical reel, because the moment we release the tension by untying one end of the warp - the whole warp will slide down. On a horizontal reel it remains in place and can be gradually transferred to the loom and beamed. This not only saves one operation, but leaves the warp in much better order than in case of its being chained. Finally a horizontal reel can be easily transformed into a beaming drum, and a vertical one cannot.

The reel has two main parts: the rotating frame, and the base. The dimensions of both depend on the size of warp wanted. The longer and wider the warp, the larger the reel, so that usually we make a compromise and settle - let's say on 30 yards of maximum length, and an average bulk - e.g. 1000 ends of 10/2 cotton.

The material used will be any good hardwood with straight grain, kiln dried if seasoned wood is not available. All parts of the rotating frame as well as of the base are made of 2 by 2 finished on all sides, which means about 1 1/4" after finishing. In all we shall need about 60 running feet of this lumber.

Fig. 1 shows the parts for the rotating frame. In this case they are held together at the corners with 5/16 bolts (2" long), but a more ambitious craftsman can make if not better, at least a better looking joint. Pieces B and C are joined with 1/2" bolts, 8" long, threaded nearly on the whole length. This length will be necessary to install an automatic feed later on.

Fig. 3 and 4 explain the construction of the base. The same 3/16 bolts are used here.

To make the cross or crosses (depending on the method used) we must have two additional pieces (fig. 5) attached to the rotating frame. The pegs can be made from an old broom handle.

The last piece at this stage is the brake (fig. 6) Two discs are cut from 5/8 plywood, one with 1/2" hole in the centre, the other

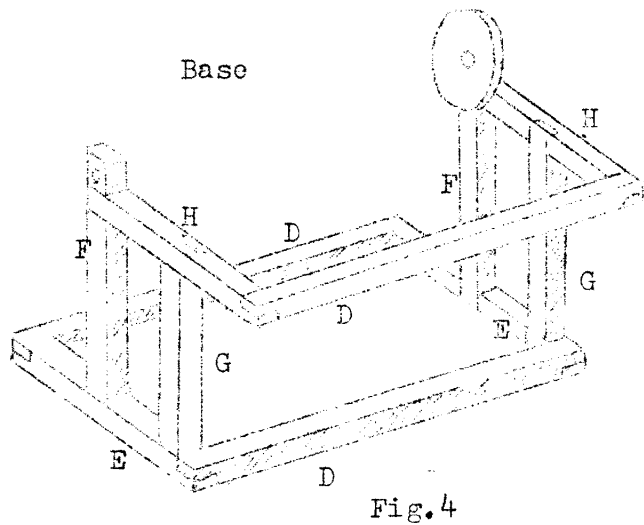
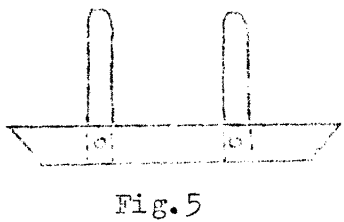
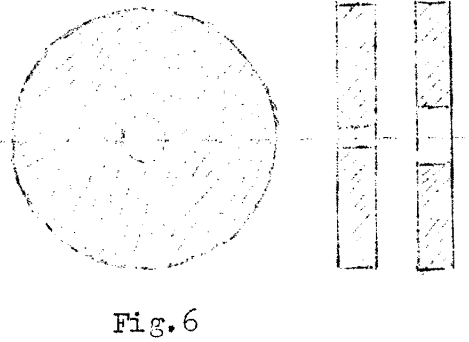
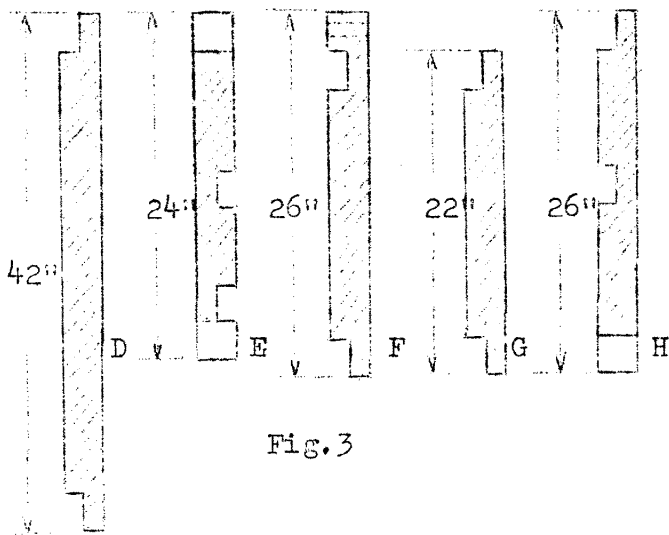
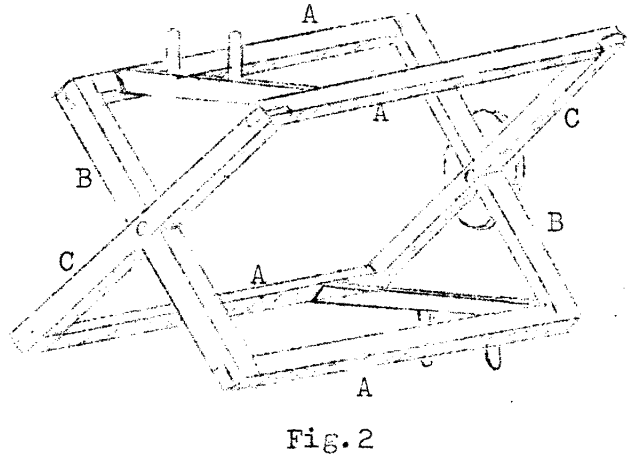
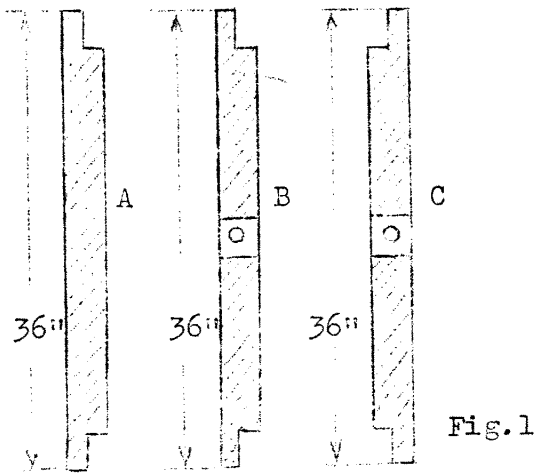

Only all over dimensions are given. Other can be figured out during work.

with 1" hole. One of those discs is screwed to the side of the frame (fig.2) and the other (with the larger hole) to the base (fig.4)

Now we can start to assemble the reel. The base comes first with the brake secured with at least three heavy screws to the pieces F and G. Then we do the same with the rotating frame (4 screws on the braking disc), but we do not insert the long  $\frac{1}{2}$ " bolts.

Then the frame is placed inside the base, so that the holes in the pieces B and C are in line with the holes in F. One  $\frac{1}{2}$ " bolt is inserted from the inside through the frame, then a washer and nut, and finally through F in the base. It has to be screwed into the nut held in place until the whole bolt passes through. Then it is tightened and a similar operation repeated with the second bolt. If the frame and the base were properly assembled, the frame should turn in the base without any effort, the two braking discs being about  $\frac{1}{2}$ " apart.

For the warping it is all we need, but the beaming directly from the reel requires tension, and the brake will furnish it. To engage the brake we need an additional nut and washer on the outside of the long bolt protruding from the base. We can tighten this nut as much as wanted, thus regulating the tension of warp.

Now the warping is done exactly as in case of a vertical reel, but if we want to use the reel for beaming as well, it is important to make the warp very carefully, winding the ends without crossing and without piling them all in one place. Later on, when we shall add the automatic feed, this will not be necessary.

There are two ways in which our reel can be used:

1) The warp is made with one cross only. The reel is placed more or less to the front of the loom but not directly in front. The brake set for a very light tension - just enough to prevent the frame from turning by itself. The lease rods are untied on one end, put through the cross (still on the reel), tied, and then the end of warp is released from the pegs (by loosening the bolt). We carry the lease rods to the loom, tie them to the frame, spread the warp on a raddle placed on the slabstock, and tie it to the back apron.

Now one person stands in front of the loom, as far from it as possible, holds the warp in both hands and walks to the loom, while the other person is turning the warp beam. The warp will gradually unwind from the warping reel.

2). The warp is made with a cross at each end. Then the reel is somehow fixed to the floor or otherwise attached, so that it cannot move. The simplest way is to take two 4" wood screws, cut off the heads and bend the ends (fig.7), then to select a place for the reel, directly in front of the loom and as far as possible, and drive the screws in the floor, so that they will hold the back beam of the base. The holes in the floor should be drilled first ( $\frac{3}{16}$  drill for a  $\frac{1}{4}$ " screw) - then they hardly show at all. The screws are removed by turning the bent end, when the beaming is finished.

Now we proceed as before, but with much higher tension, i.e. much tighter brake. We shall need one attachment to keep the warp centered in the loom. This consists of two pegs driven into a piece of wood about 3" apart (fig.8) This "gatherer" should be tied to the centre of the breast piece of the loom. The warp with the lease rods in place is unwound just enough to reach the back of the loom, the lease rods tied to the frame, and the warp placed between the 2 pegs of the gatherer (fig.9). Now it must be spread and laced to the back apron in

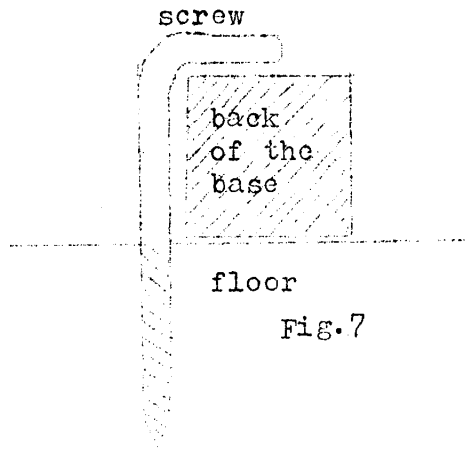

Fig. 7

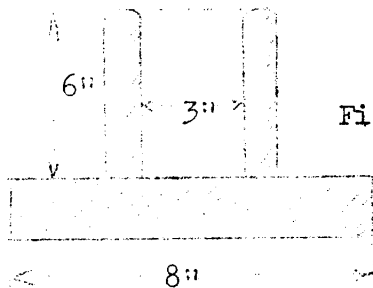

Fig. 8

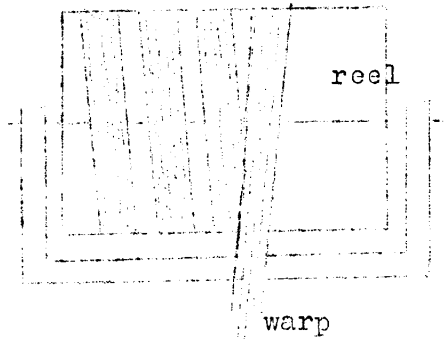
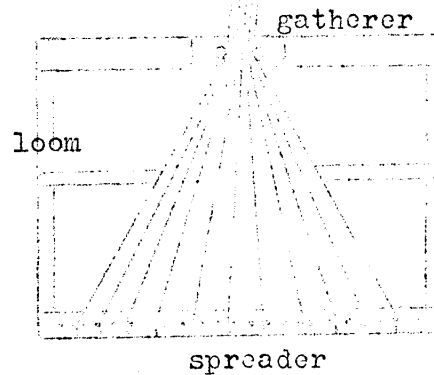

Fig. 9



such a way that the tension of warp will be even on the whole width. This is done with a long piece of a rather smooth string, which is pulled alternately through the loops in strands of warp (all strands of about the same width), and through the holes in the apron, or around a steel rod if there is one attached to the apron.

At this stage the lease-rods are removed. After having made sure that the tension of warp is even, or correcting it by adjusting the lacing string, we may start beaming. If the warp has been properly made the beaming may proceed at any speed, particularly if a roll of paper is used to separate the layers of warp. When working with sheets of paper their adjusting takes more time than the actual beaming. The paper in rolls may be either heavy wrapping paper, or building paper (not treated with anything). The latter is quite cheap and satisfactory. Care must be taken to start a roll straight or the paper will always have a tendency to go to one side.

This is of course the most efficient method of beaming, since it does not require any help, and since it goes as fast as the warp beam can be turned.

On the other hand the warping itself is longer than usual, because the warp must be prepared very carefully. In the next issue of MW we shall describe a "heck-block" or an automatic feeding attachment, which will take care of this part of our work, and which will let us do the warping in a much shorter time.

\*\*\*\*\*

I N F O R M A T I O N   S E R V I C E

Patterns in Chenille.

Chenille (or twice woven cloth) is the fastest technique of producing pile fabrics, particularly rugs. Theoretically any pattern can be woven in this way. In practice however, unless we waste a lot of yarn, the pattern must be adapted to the method.

The requirements here are rather peculiar and to satisfy them we have to understand how a piece of chenille is produced. The first weaving gives us the weft, which in weaving lies parallel to the first warp. Then this weft is cut and woven into the second warp. Thus if we use different colours, they will form horizontal stripes in the first weaving and they will become vertical in the second.

For patterns the chenille weft is not woven in long strips, but in short pieces as long as the finished rug is going to be wide.

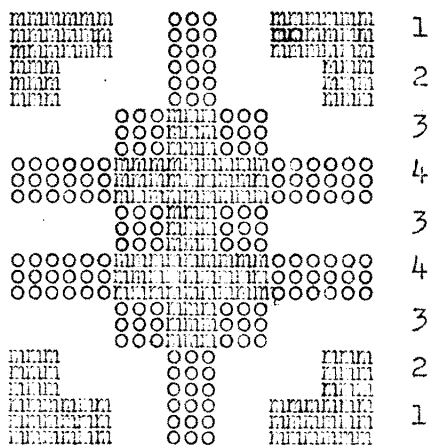

width 21"

Supposing that we are going to weave a rug as on the drawing with colours: black (m), red (o), and white (empty spaces) 21 by 27 inches, then we have to divide it into "blocks" first. The numbers on the right indicate the blocks. There are four of them, but each is repeated two or three times.

If there are about 4 shots of weft per inch, it will take 12 pieces of chenille weft for each block (of 3"). The width of the first warp will be equal to the depth of the pile, times two (pile on each side), times 12. If 1" pile is wanted, the width of the first warp is then  $1 \times 2 \times 12 = 24$  inches.

After making the warp with 12 strands spaced 2 inches, we start weaving the

first block. It has 6 inches of black, 3" of white, 3" red 3" white and 6" black. In all 21" just the width of the rug. After finishing it we weave about 2 inches of plain tabby with a thin yarn, and repeat the operation (block no.1 is used twice). The second block has: 3" black, 6" white, 3" red, 6" white, and 3" black. It is repeated also. The third block (taken three times): 6" white, 3" red, 3" black, 3" red, and 6" white. The fourth block: 6" red, 9" black, and 6" red. Repeat.

Now we have all the weft needed to make the rug. The spaces in tabby between the blocks should be painted with size, or thin glue. After the glue is dry we cut the blocks one from another, and then the strips of chenille in each block. In all we shall have 108 strips.

The next step is to make the second warp, very open and 21" wide. The strips of weft are inserted one by one, adjusted very carefully in the shed, the pile combed up and down so that none will remain in the shed, and both ends of each strip (tabby with glue) tucked under into the next shed. Binder should be used in the same shed as the pattern weft.

## INFORMATION SERVICE

We shall try to help you with your own weaving problems, answering technical questions, supplying necessary information, finding books and periodicals, and locating supplies.

Here are the rules of our Service:

- 1 - Each question will be answered by letter.
- 2 - If the problem is of a general interest we may print the answer in the Master Weaver independently from the letter.
- 3 - There is a fee of one dollar which must accompany each question. This is returned immediately if we cannot answer your question.
- 4 - If the question is of such a nature that it cannot be answered in 500 words, we may either give you information about books or other publications discussing your problem, or advise you what would be the cost of a complete answer.
- 5 - We shall try to answer your letters immediately. In exceptional cases when we shall have to consult sources not readily available, it may take up to two weeks.
- 6 - To avoid misunderstanding, your questions or problems should be presented with all details.

Send letters to: Z - Handicrafts, Fulford, Que., Canada